



ICS87950I

Low SKEW, 1-TO-9

LVC MOS / LV TTL CLOCK MULTIPLIER

GENERAL DESCRIPTION

The ICS87950I is a low voltage, low skew 1-9 LVC MOS/ LV TTL Clock Generator. With output frequencies up to 250MHz the ICS87950I is targeted for high performance clock applications. Along with a fully integrated PLL the ICS87950I contains frequency configurable outputs.

FEATURES

- Fully integrated PLL
- 9 single ended 3.3V LVC MOS/LV TTL outputs
- Selectable CLK or single ended crystal inputs
- Maximum output frequency: 250MHz
- Maximum VCO range: 240MHz to 500MHz
- Cycle-to-cycle jitter: ± 100 (typical)
- Output skew: 375ps (maximum) all outputs @ same frequency
- 3.3V operating supply
- -40°C to 85°C ambient operating temperature
- Available in both standard (RoHS 5) and lead-free (RoHS 6) packages

PIN ASSIGNMENT

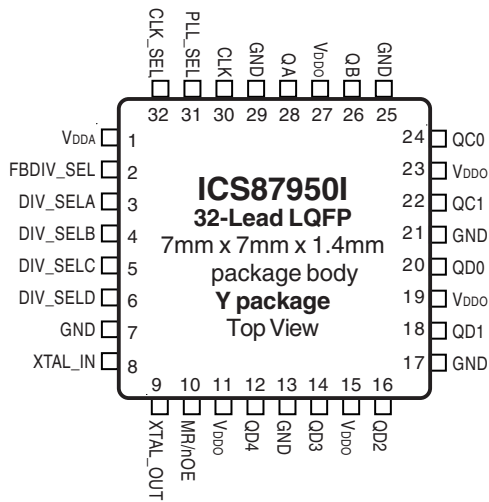

BLOCK DIAGRAM

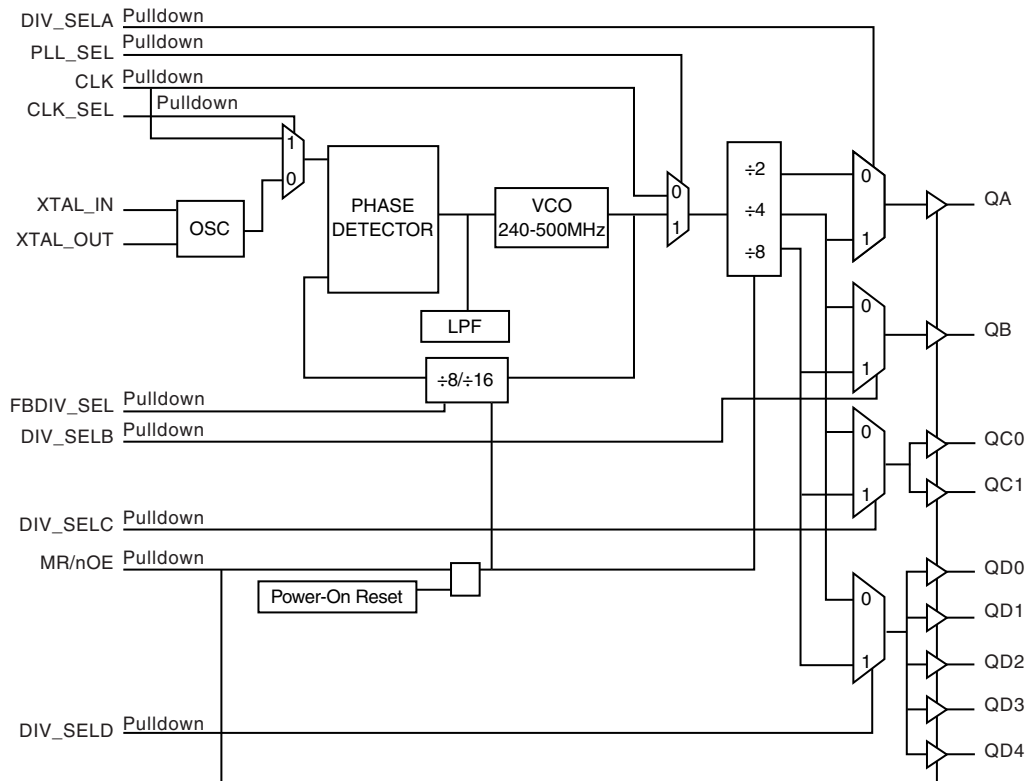



TABLE 1. PIN DESCRIPTIONS

Number	Name	Type		Description
1	V _{DDA}	Power		Analog supply pin.
2	FBDIV_SEL	Input	Pulldown	Selects divide value for Bank feedback output as described in Table 3E. LVCMOS / LVTTTL interface levels.
3	DIV_SELA	Input	Pulldown	Selects divide value for Bank A output as described in Table 3D. LVCMOS / LVTTTL interface levels.
4	DIV_SELB	Input	Pulldown	Selects divide value for Bank B output as described in Table 3D. LVCMOS / LVTTTL interface levels.
5	DIV_SELC	Input	Pulldown	Selects divide value for Bank C outputs as described in Table 3D. LVCMOS / LVTTTL interface levels.
6	DIV_SELD	Input	Pulldown	Selects divide value for Bank D outputs as described in Table 3D. LVCMOS / LVTTTL interface levels.
7, 13, 17, 21, 25, 29	GND	Power		Power supply ground.
8, 9	XTAL_IN, XTAL_OUT	Input		Crystal oscillator interface. XTAL_IN is the input, XTAL_OUT is the output.
10	MR/nOE	Input	Pulldown	Active High Master Reset. Active Low Output Enable. When logic HIGH, the internal dividers are reset and the outputs are tri-stated (HiZ). When logic LOW, the internal dividers and the outputs are enabled. LVCMOS / LVTTTL interface levels.
11, 15, 19, 23, 27	V _{DDO}	Power		Output supply pins.
12, 14, 16, 18, 20	QD4, QD3, QD2, QD1, QD0	Output		Bank D clock outputs. 7Ω typical output impedance. LVCMOS / LVTTTL interface levels.
22, 24	QC1, QC0	Output		Bank C clock outputs. 7Ω typical output impedance. LVCMOS / LVTTTL interface levels.
26	QB	Output		Bank B clock output. 7Ω typical output impedance. LVCMOS / LVTTTL interface levels.
28	QA	Output		Bank A clock output. 7Ω typical output impedance. LVCMOS / LVTTTL interface levels.
30	CLK	Input	Pulldown	LVCMOS / LVTTTL phase detector reference clock input.
31	PLL_SEL	Input	Pulldown	Selects between the PLL and the reference clock as the input to the dividers. When HIGH, selects PLL. When LOW, selects the reference clock. LVCMOS / LVTTTL interface levels.
32	CLK_SEL	Input	Pulldown	Clock select input. When HIGH, selects CLK. When LOW, selects XTAL_IN, XTAL_OUT. LVCMOS / LVTTTL interface levels.

NOTE: *Pulldown* refers to internal input resistors. See Table 2, Pin Characteristics, for typical values.

TABLE 2. PIN CHARACTERISTICS

Symbol	Parameter	Test Conditions	Minimum	Typical	Maximum	Units
C _{IN}	Input Capacitance			4		pF
C _{PD}	Power Dissipation Capacitance (per output)	V _{DDA} , V _{DDO} = 3.47V		25		pF
R _{PULLDOWN}	Input Pulldown Resistor			51		kΩ
R _{OUT}	Output Impedance		5	7	12	Ω



TABLE 3A. OUTPUT CONTROL PIN FUNCTION TABLE

Inputs	Outputs			
MR/nOE	QA	QB	QC0, QC1	QD0:QD4
1	HiZ	HiZ	HiZ	HiZ
0	Enabled	Enabled	Enabled	Enabled

TABLE 3B. OPERATING MODE FUNCTION TABLE

Inputs	Operating Mode
PLL_SEL	
0	Bypass
1	PLL

TABLE 3C. PLL INPUT FUNCTION TABLE

Inputs	
CLK_SEL	PLL Input
0	XTAL Oscillator
1	CLK

TABLE 3D. PROGRAMMABLE OUTPUT FREQUENCY FUNCTION TABLE FOR FBDIV-SEL

Inputs	
FBDIV_SEL	Function
1	÷8
0	÷16



TABLE 3E. PROGRAMMABLE OUTPUT FREQUENCY FUNCTION TABLE

Inputs				Outputs			
DIV_SELA	DIV_SELB	DIV_SELc	DIV_SELD	QA	QB	QCx	QDx
0	0	0	0	VCO/2	VCO/4	VCO/4	VCO/4
0	0	0	1	VCO/2	VCO/4	VCO/4	VCO/8
0	0	1	0	VCO/2	VCO/4	VCO/8	VCO/4
0	0	1	1	VCO/2	VCO/4	VCO/8	VCO/8
0	1	0	0	VCO/2	VCO/8	VCO/4	VCO/4
0	1	0	1	VCO/2	VCO/8	VCO/4	VCO/8
0	1	1	0	VCO/2	VCO/8	VCO/8	VCO/4
0	1	1	1	VCO/2	VCO/8	VCO/8	VCO/8
1	0	0	0	VCO/4	VCO/4	VCO/4	VCO/4
1	0	0	1	VCO/4	VCO/4	VCO/4	VCO/8
1	0	1	0	VCO/4	VCO/4	VCO/8	VCO/4
1	0	1	1	VCO/4	VCO/4	VCO/8	VCO/8
1	1	0	0	VCO/4	VCO/8	VCO/4	VCO/4
1	1	0	1	VCO/4	VCO/8	VCO/4	VCO/8
1	1	1	0	VCO/4	VCO/8	VCO/8	VCO/4
1	1	1	1	VCO/4	VCO/8	VCO/8	VCO/8

TABLE 3F. INPUT REFERENCE VS. OUTPUT FREQUENCY RELATIONSHIP

Inputs				Outputs							
DIV_SELA	DIV_SELB	DIV_SELc	DIV_SELD	FBDIV_SEL = 1				FBDIV_SEL = 0			
				QA	QB	QCx	QDx	QA	QB	QCx	QDx
0	0	0	0	4x	2x	2x	2x	8x	4x	4x	4x
0	0	0	1	4x	2x	2x	x	8x	4x	4x	2x
0	0	1	0	4x	2x	x	2x	8x	4x	2x	4x
0	0	1	1	4x	2x	x	x	8x	4x	2x	2x
0	1	0	0	4x	x	2x	2x	8x	2x	4x	4x
0	1	0	1	4x	x	2x	x	8x	2x	4x	2x
0	1	1	0	4x	x	x	2x	8x	2x	2x	4x
0	1	1	1	4x	x	x	x	8x	2x	2x	2x
1	0	0	0	2x	2x	2x	2x	4x	4x	4x	4x
1	0	0	1	2x	2x	2x	x	4x	4x	4x	2x
1	0	1	0	2x	2x	x	2x	4x	4x	2x	4x
1	0	1	1	2x	2x	x	x	4x	4x	2x	2x
1	1	0	0	2x	x	2x	2x	4x	2x	4x	4x
1	1	0	1	2x	x	2x	x	4x	2x	4x	2x
1	1	1	0	2x	x	x	2x	4x	2x	2x	4x
1	1	1	1	2x	x	x	x	4x	2x	2x	2x



ICS87950I

LOW SKEW, 1-TO-9 LVCMOS / LVTTTL CLOCK MULTIPLIER

ABSOLUTE MAXIMUM RATINGS

Supply Voltage, V_{DD}	4.6V
Inputs, V_I	-0.5V to $V_{DDA} + 0.5V$
Outputs, V_O	-0.5V to $V_{DDO} + 0.5V$
Package Thermal Impedance, θ_{JA}	42.1°C/W (0 lfpm)
Storage Temperature, T_{STG}	-65°C to 150°C

NOTE: Stresses beyond those listed under Absolute Maximum Ratings may cause permanent damage to the device. These ratings are stress specifications only. Functional operation of product at these conditions or any conditions beyond those listed in the *DC Characteristics* or *AC Characteristics* is not implied. Exposure to absolute maximum rating conditions for extended periods may affect product reliability.

TABLE 4A. POWER SUPPLY DC CHARACTERISTICS, $V_{DDA} = V_{DDO} = 3.3V \pm 5\%$, $T_A = -40^\circ\text{C}$ TO 85°C

Symbol	Parameter	Test Conditions	Minimum	Typical	Maximum	Units
V_{DDA}	Analog Supply Voltage		3.135	3.3	3.465	V
V_{DDO}	Output Supply Voltage		3.135	3.3	3.465	V
I_{DDA}	Analog Supply Current				15	mA
I_{DDO}	Output Supply Current				115	mA

TABLE 4B. LVCMOS/LVTTTL DC CHARACTERISTICS, $V_{DDA} = V_{DDO} = 3.3V \pm 5\%$, $T_A = -40^\circ\text{C}$ TO 85°C

Symbol	Parameter	Test Conditions	Minimum	Typical	Maximum	Units
V_{IH}	Input High Voltage		2		$V_{DD} + 0.3$	V
V_{IL}	Input Low Voltage		-0.3		0.8	V
I_{IN}	Input Current	$V_{DDA} = V_{IN} = 3.465V$			± 120	μA
V_{OH}	Output High Voltage; NOTE 1		2.6			V
V_{OL}	Output Low Voltage; NOTE 1				0.5	V

NOTE 1: Outputs terminated with 50Ω to $V_{DDO}/2$.

TABLE 5. CRYSTAL CHARACTERISTICS, $V_{DDA} = V_{DDO} = 3.3V \pm 5\%$, $T_A = -40^\circ\text{C}$ TO 85°C

Parameter	Test Conditions	Minimum	Typical	Maximum	Units
Mode of Oscillation		Fundamental			
Frequency		15		40	MHz
Equivalent Series Resistance (ESR)				50	Ω
Shunt Capacitance				7	pF
Drive Level				1	mW

TABLE 6. PLL INPUT REFERENCE CHARACTERISTICS, $V_{DDA} = V_{DDO} = 3.3V \pm 5\%$, $T_A = -40^\circ\text{C}$ TO 85°C

Symbol	Parameter	Test Conditions	Minimum	Typical	Maximum	Units
f_{REF}	Input Reference Frequency; NOTE 1		15		62.5	MHz

NOTE 1: Maximum and minimum input reference is limited by the VCO lock range and the feedback divider for the CLK input.



ICS87950I

LOW SKEW, 1-TO-9 LVCMOS / LVTTTL CLOCK MULTIPLIER

TABLE 7. AC CHARACTERISTICS, $V_{DDA} = V_{DDO} = 3.3V \pm 5\%$, $T_A = -40^\circ C$ TO $85^\circ C$

Symbol	Parameter	Test Conditions	Minimum	Typical	Maximum	Units	
f_{MAX}	Output Frequency	± 2			250	MHz	
		± 4			125	MHz	
		± 8			62.5	MHz	
f_{VCO}	PLL VCO Lock Range		240		500	MHz	
$t_{sk(o)}$	Output Skew; NOTE 1, 4	Same Frequency			375	ps	
		Different Frequency	QA $f_{MAX} < 150MHz$			500	ps
			QA $f_{MAX} > 150MHz$			750	ps
$f_{jit(cc)}$	Cycle-to-Cycle Jitter; NOTE 2, 4			± 100		ps	
t_L	PLL Lock Time; NOTE 4				10	mS	
t_R / t_F	Output Rise/Fall Time	0.8V to 2V	0.1		1	ns	
t_{PW}	Output Pulse Width; NOTE 3		$t_{PERIOD}/2 - 1000$		$t_{PERIOD}/2 + 1000$	ps	
t_{PZL}, t_{PZH}	Output Enable Time				6	ns	
t_{PLZ}, t_{PHZ}	Output Disable Time				7	ns	

All parameters measured at f_{MAX} unless noted otherwise.

NOTE 1: Defined as skew between outputs at the same supply voltage and with equal load conditions.

Measured at $V_{DDO}/2$.

NOTE 2: Jitter performance using Xtal inputs.

NOTE 3: Measured using CLK.

NOTE 4: This parameter is defined in accordance with JEDEC Standard 65.

PARAMETER MEASUREMENT INFORMATION

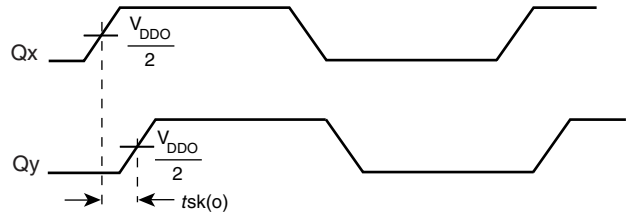
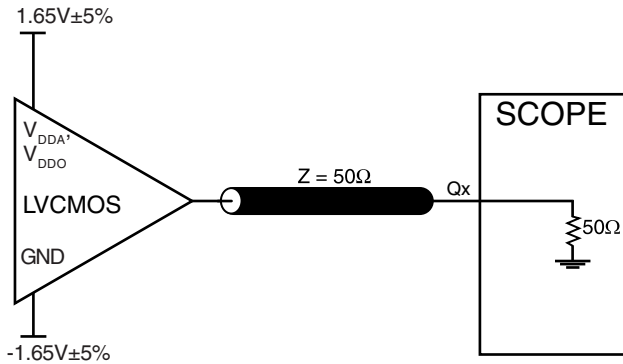

3.3V OUTPUT LOAD AC TEST CIRCUIT

OUTPUT SKEW

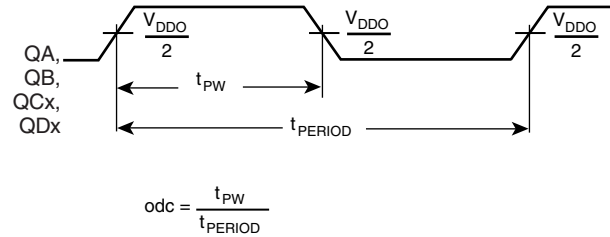
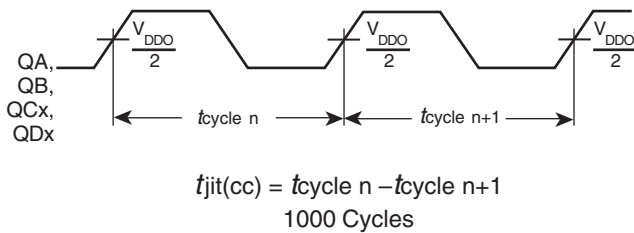

CYCLE-TO-CYCLE JITTER

OUTPUT PULSE WIDTH/PERIOD

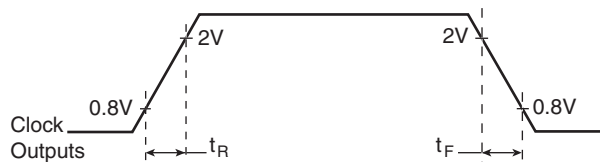

OUTPUT RISE/FALL TIME

APPLICATION INFORMATION

POWER SUPPLY FILTERING TECHNIQUES

As in any high speed analog circuitry, the power supply pins are vulnerable to random noise. The ICS87950I provides separate power supplies to isolate any high switching noise from the outputs to the internal PLL. V_{DDO} and V_{DDA} should be individually connected to the power supply plane through vias, and bypass capacitors should be used for each pin. To achieve optimum jitter performance, power supply isolation is required. *Figure 1* illustrates how a 10Ω resistor along with a $10\mu\text{F}$ and a $.01\mu\text{F}$ bypass capacitor should be connected to each V_{DDA} pin.

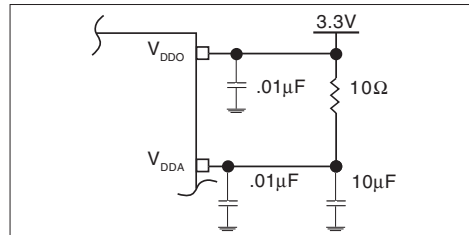

FIGURE 1. POWER SUPPLY FILTERING

CRYSTAL INPUT INTERFACE

The ICS87950I has been characterized with 18pF parallel resonant crystals. The capacitor values, C1 and C2, shown in *Figure 2* below were determined using a 25MHz, 18pF parallel resonant crystal and were chosen to minimize the ppm error.

These same capacitor values will tune any 18pF parallel resonant crystal over the frequency range and other parameters specified in this data sheet. The optimum C1 and C2 values can be slightly adjusted for different board layouts.

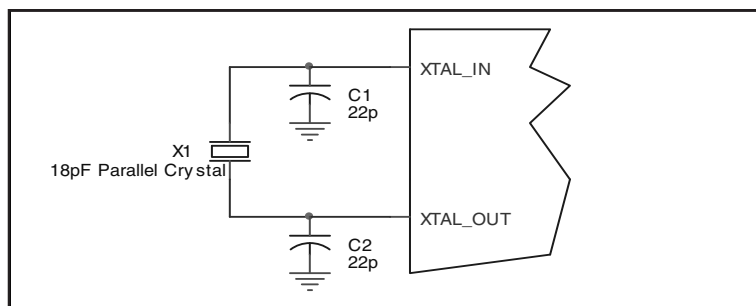

FIGURE 2. CRYSTAL INPUT INTERFACE



RELIABILITY INFORMATION

TABLE 8. θ_{JA} VS. AIR FLOW TABLE FOR 32 LEAD LQFP

θ_{JA} by Velocity (Linear Feet per Minute)			
	0	200	500
Single-Layer PCB, JEDEC Standard Test Boards	67.8°C/W	55.9°C/W	50.1°C/W
Multi-Layer PCB, JEDEC Standard Test Boards	47.9°C/W	42.1°C/W	39.4°C/W

NOTE: Most modern PCB designs use multi-layered boards. The data in the second row pertains to most designs.

TRANSISTOR COUNT

The transistor count for ICS87950I is: 2674

PACKAGE OUTLINE - Y SUFFIX FOR 32 LEAD LQFP

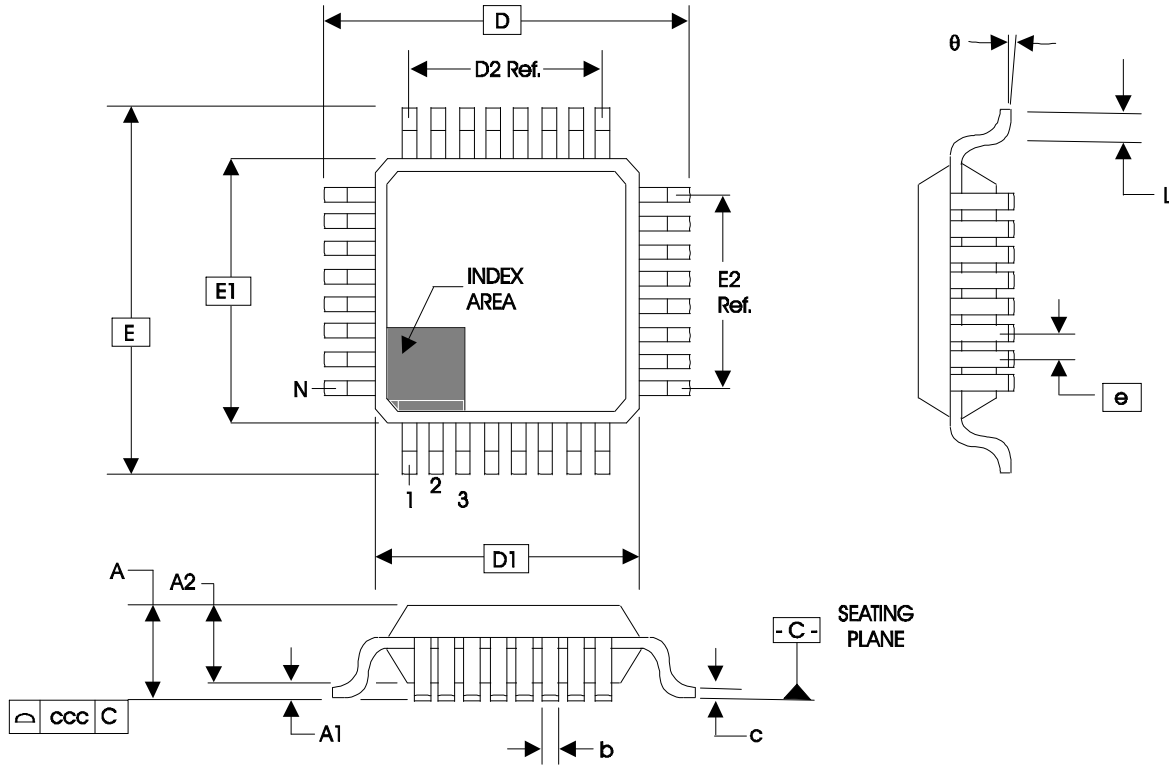

TABLE 9. PACKAGE DIMENSIONS

JEDEC VARIATION ALL DIMENSIONS IN MILLIMETERS			
SYMBOL	BBA		
	MINIMUM	NOMINAL	MAXIMUM
N	32		
A	--	--	1.60
A1	0.05	--	0.15
A2	1.35	1.40	1.45
b	0.30	0.37	0.45
c	0.09	--	0.20
D	9.00 BASIC		
D1	7.00 BASIC		
D2	5.60 Ref.		
E	9.00 BASIC		
E1	7.00 BASIC		
E2	5.60 Ref.		
e	0.80 BASIC		
L	0.45	0.60	0.75
θ	0°	--	7°
ccc	--	--	0.10

Reference Document: JEDEC Publication 95, MS-026



ICS87950I

LOW SKEW, 1-TO-9
LVCMOS / LVTTTL CLOCK MULTIPLIER

TABLE 10. ORDERING INFORMATION

Part/Order Number	Marking	Package	Shipping Packaging	Temperature
87950BYI	ICS87950BYI	32 Lead LQFP	tray	-40°C to 85°C
87950BYIT	ICS87950BYI	32 Lead LQFP	1000 tape & reel	-40°C to 85°C
87950BYILF	ICS87950BYIL	32 Lead "Lead-Free" LQFP	tray	-40°C to 85°C
87950BYILFT	ICS87950BYIL	32 Lead "Lead-Free" LQFP	1000 tape & reel	-40°C to 85°C

NOTE: Parts that are ordered with an "LF" suffix to the part number are the Pb-Free configuration and are RoHS compliant.

While the information presented herein has been checked for both accuracy and reliability, Integrated Device Technology, Inc. (IDT) assumes no responsibility for either its use or for infringement of any patents or other rights of third parties, which would result from its use. No other circuits, patents, or licenses are implied. This product is intended for use in normal commercial and industrial applications. Any other applications such as those requiring high reliability, or other extraordinary environmental requirements are not recommended without additional processing by IDT. IDT reserves the right to change any circuitry or specifications without notice. IDT does not authorize or warrant any IDT product for use in life support devices or critical medical instruments.



ICS87950I
LOW SKEW, 1-TO-9
LVCMOS / LVTTTL CLOCK MULTIPLIER

REVISION HISTORY SHEET				
Rev	Table	Page	Description of Change	Date
B	T5	1	Features Section - added Lead-Free bullet.	6/14/05
	T10	5	Crystal Characteristics Table - added Drive Level.	
	T10	11	Ordering Information Table - added Lead-Free part number and note. Changed XTAL1/2 naming convention to XTAL_IN/_OUT throughout the datasheet.	
B	T10	11	Ordering Information - Added Lead-Free Marking.	9/8/08
C	T10	11	Updated datasheet's header/footer with IDT from ICS.	7/16/10
		13	Removed ICS prefix from Part/Order Number column. Added Contact Page.	



ICS87950I
LOW SKEW, 1-TO-9
LVCMOS / LVTTTL CLOCK MULTIPLIER

We've Got Your Timing Solution.



6024 Silver Creek Valley Road
San Jose, CA 95138

Sales
800-345-7015 (inside USA)
+408-284-8200 (outside USA)
Fax: 408-284-2775

Tech Support
netcom@idt.com

© 2010 Integrated Device Technology, Inc. All rights reserved. Product specifications subject to change without notice. IDT, the IDT logo, ICS and HiPerClockS are trademarks of Integrated Device Technology, Inc. Accelerated Thinking is a service mark of Integrated Device Technology, Inc. All other brands, product names and marks are or may be trademarks or registered trademarks used to identify products or services of their respective owners.
Printed in USA