

IR2117(S)/IR2118(S) & (PbF)

SINGLE CHANNEL DRIVER

Features

- Floating channel designed for bootstrap operation
Fully operational to +600V
Tolerant to negative transient voltage
dV/dt immune
- Gate drive supply range from 10 to 20V
- Undervoltage lockout
- CMOS Schmitt-triggered inputs with pull-down
- Output in phase with input (IR2117) or out of phase with input (IR2118)
- Also available LEAD-FREE

Description

The IR2117/IR2118(S) is a high voltage, high speed power MOSFET and IGBT driver. Proprietary HVIC and latch immune CMOS technologies enable ruggedized monolithic construction. The logic input is compatible with standard CMOS outputs. The output driver features a high pulse current buffer stage designed for minimum cross-conduction. The floating channel can be used to drive an N-channel power MOSFET or IGBT in the high or low side configuration which operates up to 600 volts.

Product Summary

V_{OFFSET}	600V max.
$I_{\text{O}+/-}$	200 mA / 420 mA
V_{OUT}	10 - 20V
$t_{\text{on/off}}$ (typ.)	125 & 105 ns

Packages

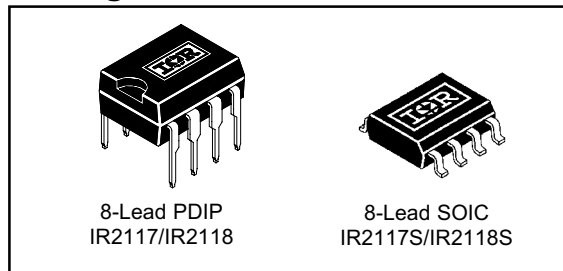

Typical Connection

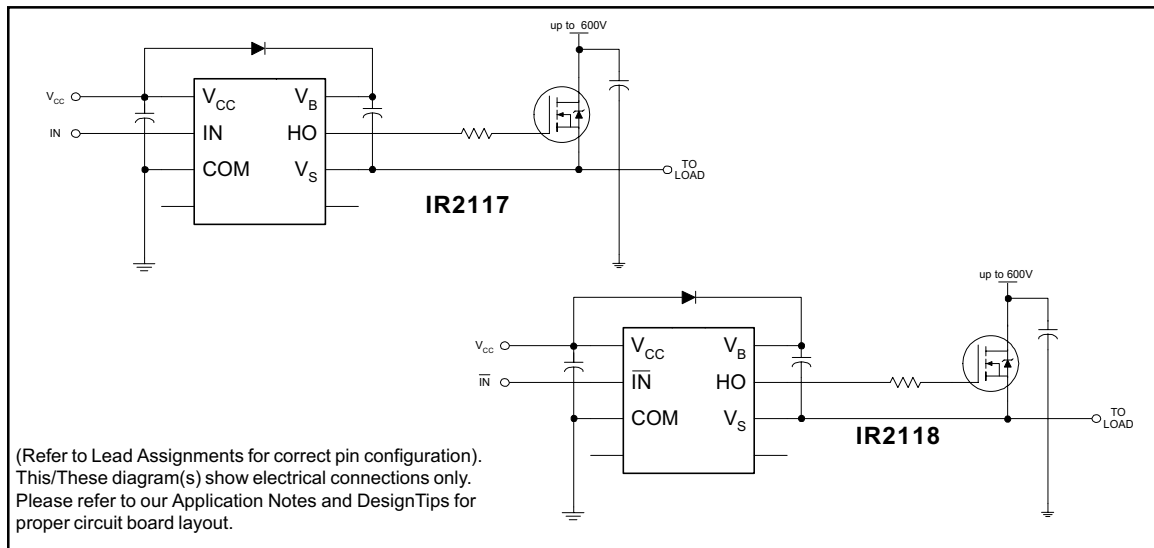

IR2117(S)/IR2118(S) & (PbF)

International
IR Rectifier

Absolute Maximum Ratings

Absolute maximum ratings indicate sustained limits beyond which damage to the device may occur. All voltage parameters are absolute voltages referenced to COM. The thermal resistance and power dissipation ratings are measured under board mounted and still air conditions. Additional information is shown in Figures 5 through 8.

Symbol	Definition	Min.	Max.	Units	
V _B	High side floating supply voltage	-0.3	625	V	
V _S	High side floating supply offset voltage	V _B - 25	V _B + 0.3		
V _{HO}	High side floating output voltage	V _S - 0.3	V _B + 0.3		
V _{CC}	Logic supply voltage	-0.3	25		
V _{IN}	Logic input voltage	-0.3	V _{CC} + 0.3		
dV _S /dt	Allowable offset supply voltage transient (figure 2)	—	50	V/ns	
P _D	Package power dissipation @ T _A ≤ +25°C	(8 lead PDIP)	—	1.0	W
		(8 lead SOIC)	—	0.625	
R _{thJA}	Thermal resistance, junction to ambient	(8 lead PDIP)	—	125	°C/W
		(8 lead SOIC)	—	200	
T _J	Junction temperature	—	150	°C	
T _S	Storage temperature	-55	150		
T _L	Lead temperature (soldering, 10 seconds)	—	300		

Recommended Operating Conditions

The input/output logic timing diagram is shown in figure 1. For proper operation the device should be used within the recommended conditions. The V_S offset rating is tested with all supplies biased at 15V differential.

Symbol	Definition	Min.	Max.	Units
V _B	High side floating supply absolute voltage	V _S + 10	V _S + 20	V
V _S	High side floating supply offset voltage	Note 1	600	
V _{HO}	High side floating output voltage	V _S	V _B	
V _{CC}	Logic supply voltage	10	20	
V _{IN}	Logic input voltage	0	V _{CC}	
T _A	Ambient temperature	-40	125	°C

Note 1: Logic operational for V_S of -5 to +600V. Logic state held for V_S of -5V to -V_{BS}. (Please refer to the Design Tip DT97-3 for more details).

Dynamic Electrical Characteristics

V_{BIAS} (V_{CC} , V_{BS}) = 15V, C_L = 1000 pF and T_A = 25°C unless otherwise specified. The dynamic electrical characteristics are measured using the test circuit shown in Figure 3.

Symbol	Definition	Min.	Typ.	Max.	Units	Test Conditions
t_{on}	Turn-on propagation delay	—	125	200	ns	$V_S = 0V$
t_{off}	Turn-off propagation delay	—	105	180		$V_S = 600V$
t_r	Turn-on rise time	—	80	130		
t_f	Turn-off fall time	—	40	65		

Static Electrical Characteristics

V_{BIAS} (V_{CC} , V_{BS}) = 15V and T_A = 25°C unless otherwise specified. The V_{IN} , V_{TH} and I_{IN} parameters are referenced to COM. The V_O and I_O parameters are referenced to COM and are applicable to the respective output leads: HO or LO.

Symbol	Definition	Min.	Typ.	Max.	Units	Test Conditions
V_{IH}	input voltage - logic "1" (IR2117) logic "0" (IR2118)	9.5	—	—	V	
V_{IL}	Input voltage - logic "0" (IR2117) logic "1" (IR2118)	—	—	6.0		
V_{OH}	High level output voltage, $V_{BIAS} - V_O$	—	—	100	mV	$I_O = 0A$
V_{OL}	Low level output voltage, V_O	—	—	100		$I_O = 0A$
I_{LK}	Offset supply leakage current	—	—	50	μA	$V_B = V_S = 600V$
I_{QBS}	Quiescent V_{BS} supply current	—	50	240		$V_{IN} = 0V$ or V_{CC}
I_{QCC}	Quiescent V_{CC} Supply Current	—	70	340		$V_{IN} = 0V$ or V_{CC}
I_{IN+}	Logic "1" input bias current (IR2117)	—	20	40		$V_{IN} = V_{CC}$
	(IR2118)					$V_{IN} = 0V$
I_{IN-}	Logic "0" input bias current (IR2117)	—	—	1.0		$V_{IN} = 0V$
	(IR2118)				$V_{IN} = V_{CC}$	
V_{BSUV+}	V_{BS} supply undervoltage positive going threshold	7.6	8.6	9.6	V	
V_{BSUV-}	V_{BS} supply undervoltage negative going threshold	7.2	8.2	9.2		
V_{CCUV+}	V_{CC} supply undervoltage positive going threshold	7.6	8.6	9.6		
V_{CCUV-}	V_{CC} supply undervoltage negative going threshold	7.2	8.2	9.2		
I_{O+}	Output high short circuit pulsed current	200	250	—	mA	$V_O = 0V$ $V_{IN} = \text{Logic "1"}$ $PW \leq 10 \mu s$
I_{O-}	Output low short circuit pulsed current	420	500	—		$V_O = 15V$ $V_{IN} = \text{Logic "0"}$ $PW \leq 10 \mu s$

IR2117(S)/IR2118(S) & (PbF)

Functional Block Diagram (IR2117)

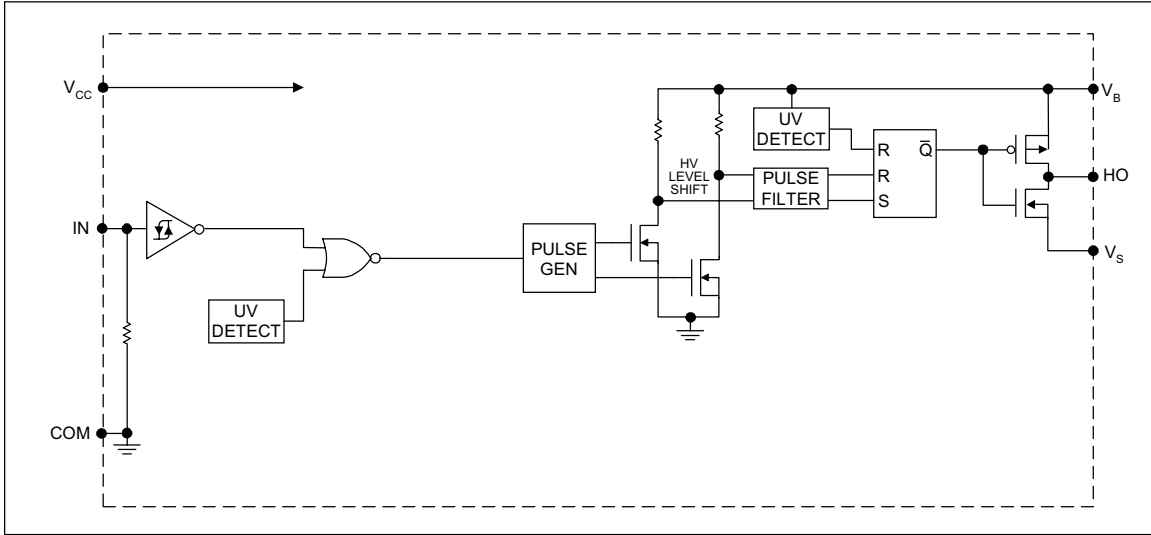

Functional Block Diagram (IR2118)

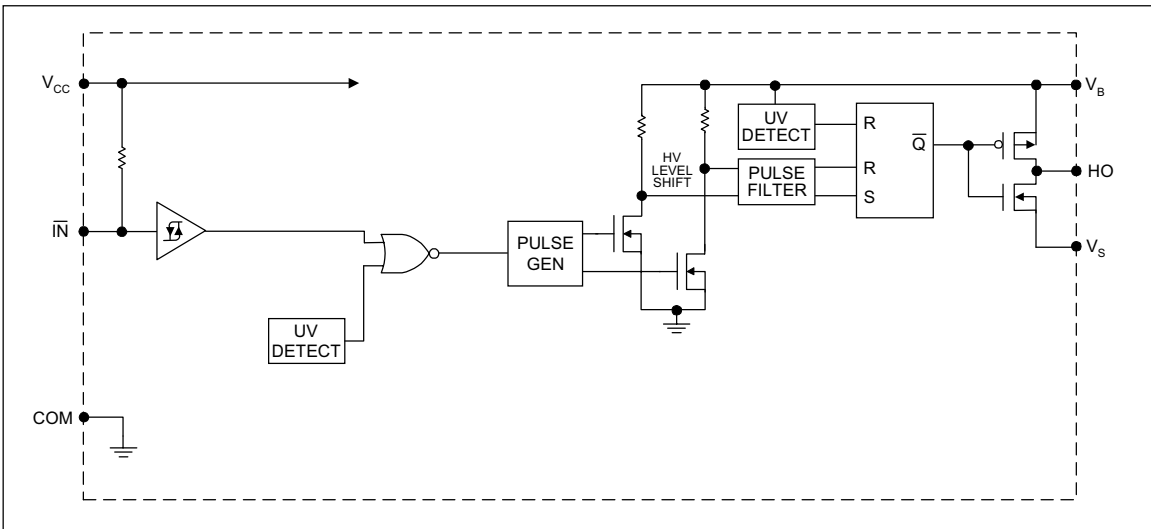

Lead Definitions

Symbol	Description
V _{CC}	Logic and gate drive supply
IN	Logic input for gate driver output (HO), in phase with HO (IR2117)
$\overline{\text{IN}}$	Logic input for gate driver output (HO), out of phase with HO (IR2118)
COM	Logic ground
V _B	High side floating supply
HO	High side gate drive output
V _S	High side floating supply return

Lead Assignments

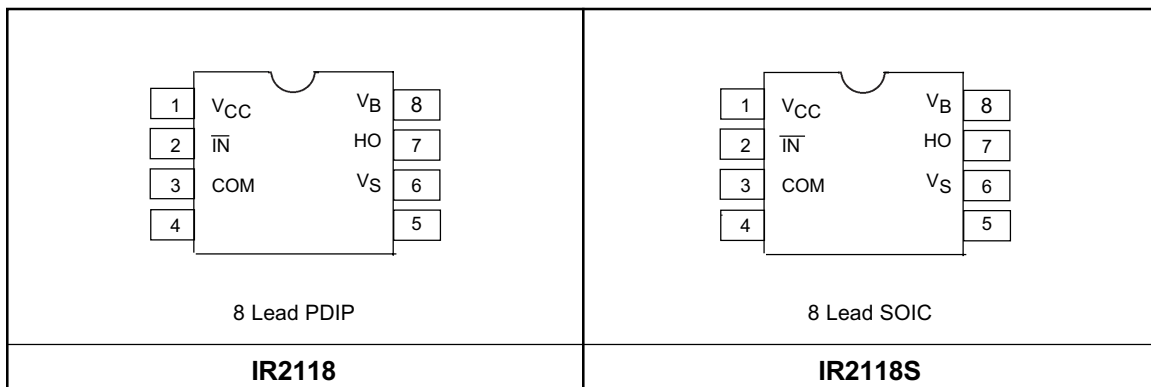
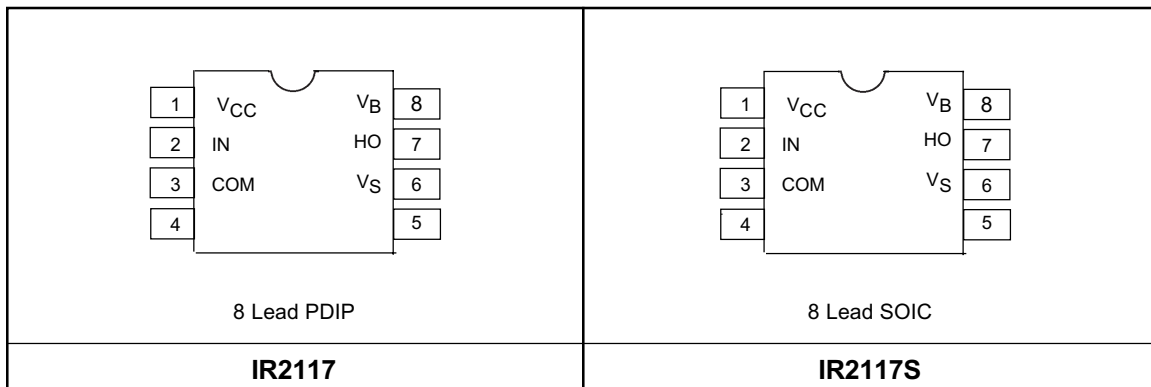

IR2117(S)/IR2118(S) & (PbF)

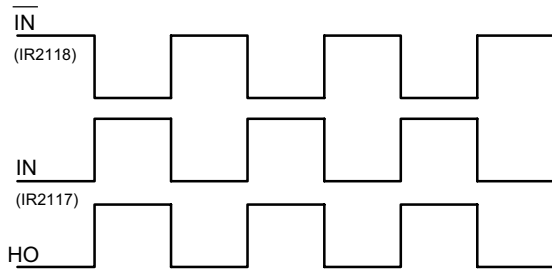

Figure 1. Input/Output Timing Diagram

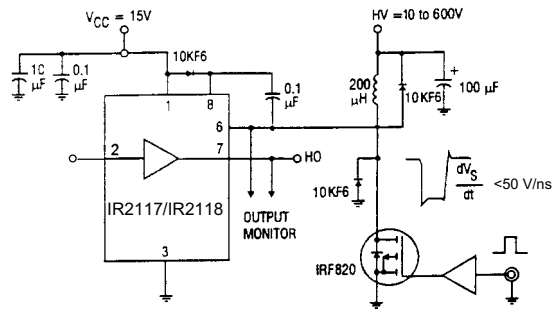

Figure 2. Floating Supply Voltage Transient Test Circuit

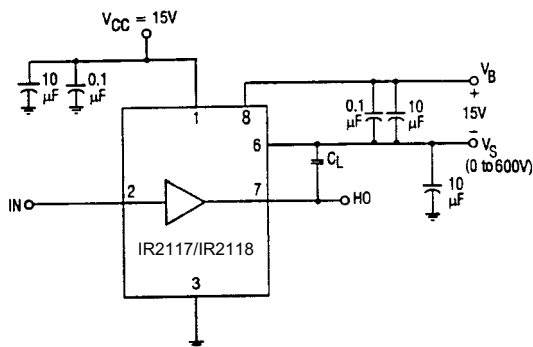

Figure 3. Switching Time Test Circuit

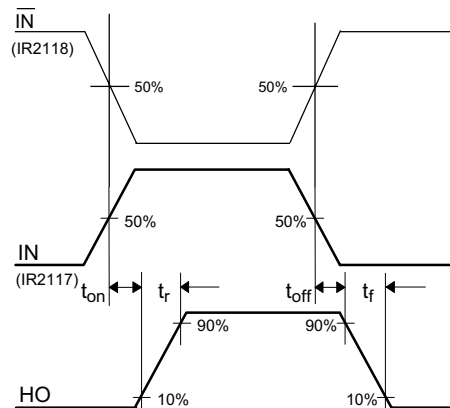

Figure 4. Switching Time Waveform Definition

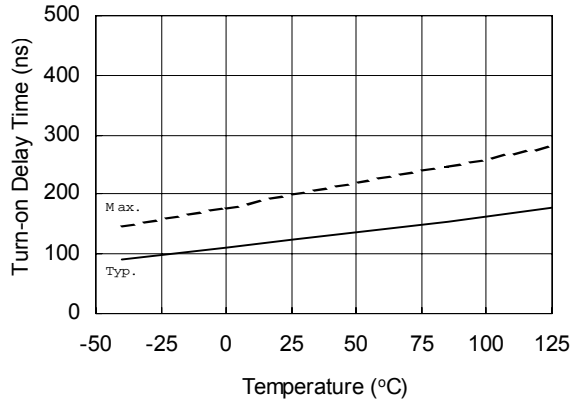

Figure 4A. Turn-On Time vs. Temperature

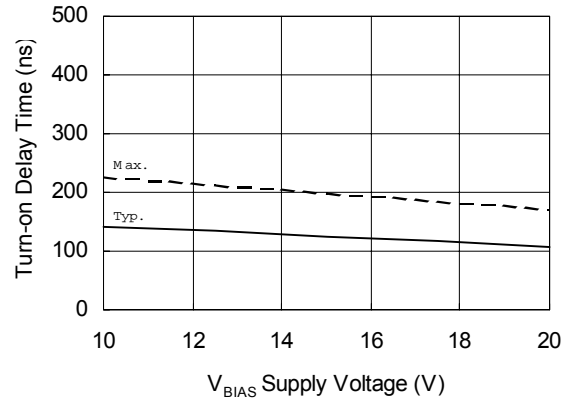

Figure 4B. Turn-On Time vs. Supply Voltage

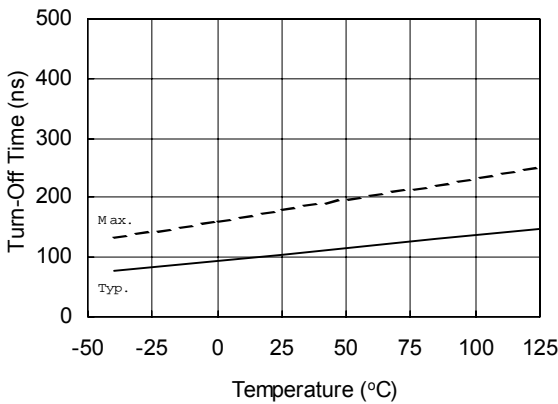

Figure 5A. Turn-Off Time vs. Temperature

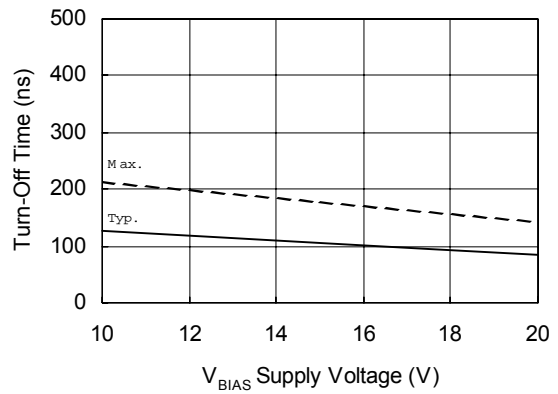

Figure 5B. Turn-Off Time vs. Supply Voltage

IR2117(S)/IR2118(S) & (PbF)

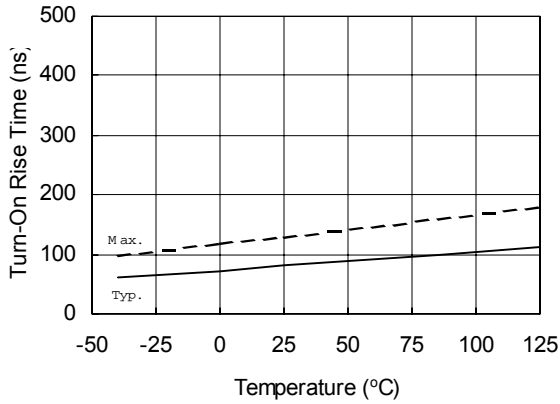

Figure 6A. Turn-On Rise Time vs. Temperature

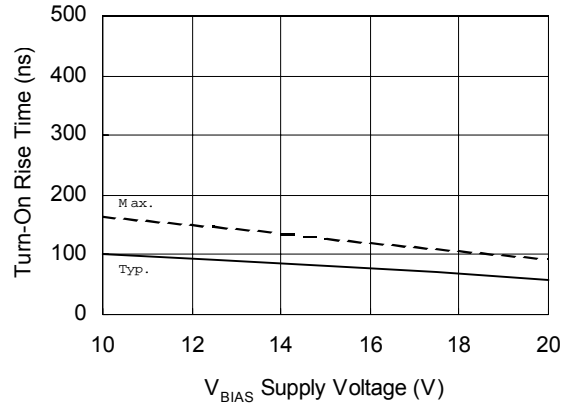

Figure 6B. Turn-On Rise Time vs. Supply Voltage

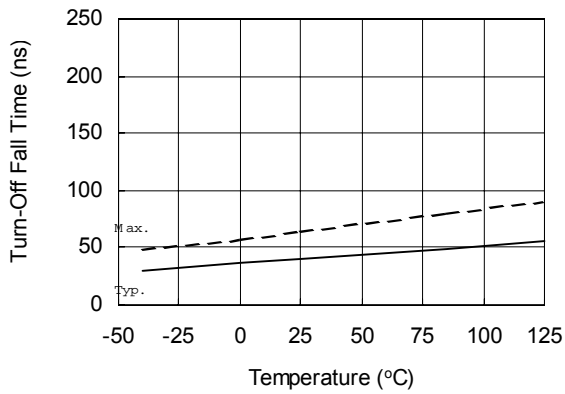

Figure 7A. Turn-Off Fall Time vs. Temperature

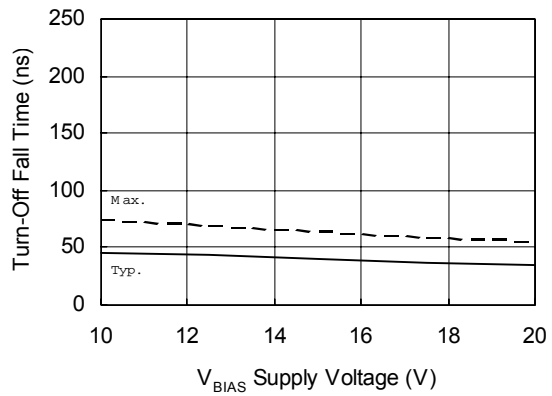

Figure 7B. Turn-Off Fall Time vs. Supply Voltage

IR2117(S)/IR2118(S) & (PbF)

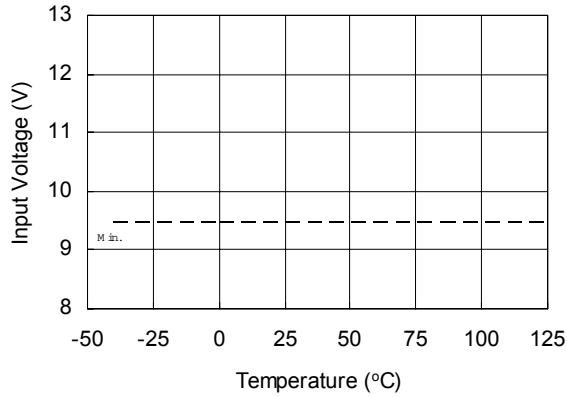

Figure 8A. Logic "1" (IR2118 "0") Input Voltage vs. Temperature

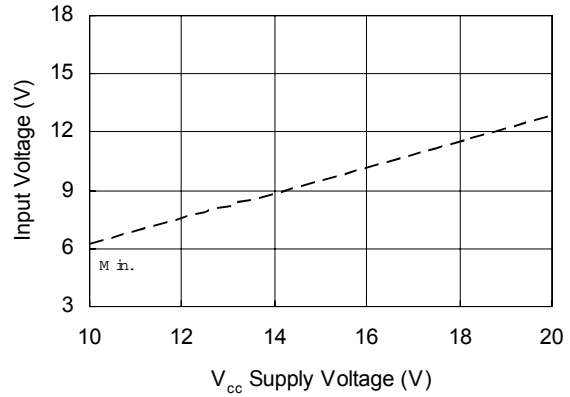

Figure 8B. Logic "1" (IR2118 "0") Input Voltage vs. Supply Voltage

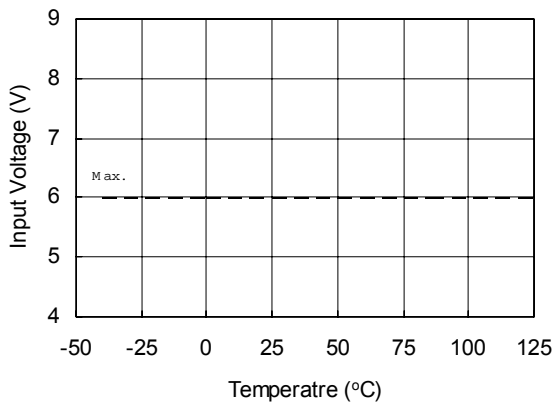

Figure 9A. Logic "0" (IR2118 "1") Input Voltage vs. Temperature

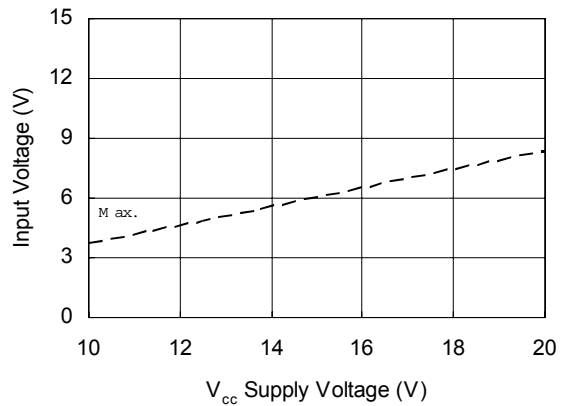

Figure 9B. Logic "0" (IR2118 "1") Input Voltage vs. Supply Voltage

IR2117(S)/IR2118(S) & (PbF)

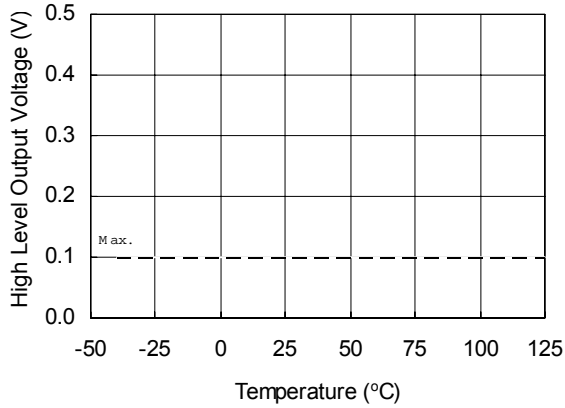

Figure 10A. High Level Output vs. Temperature

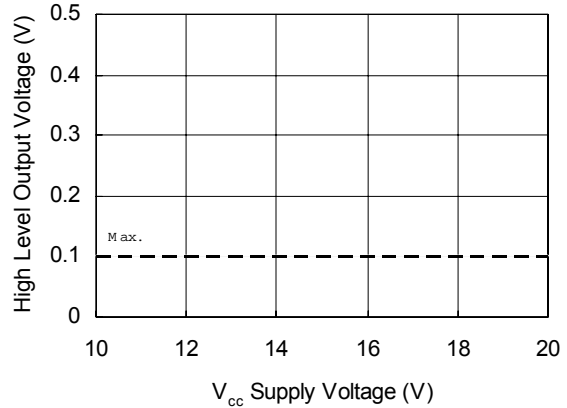

Figure 10B. High Level Output vs. Supply Voltage

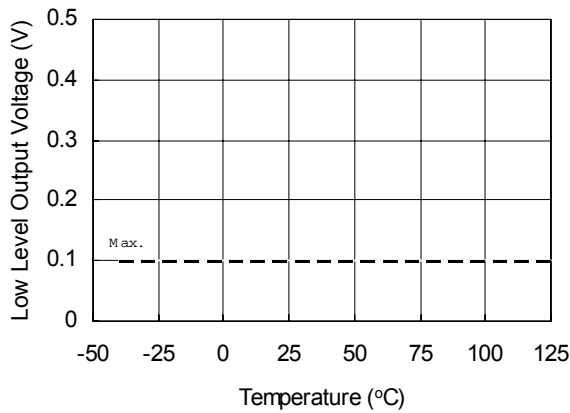

Figure 11A. Low Level Output vs. Temperature

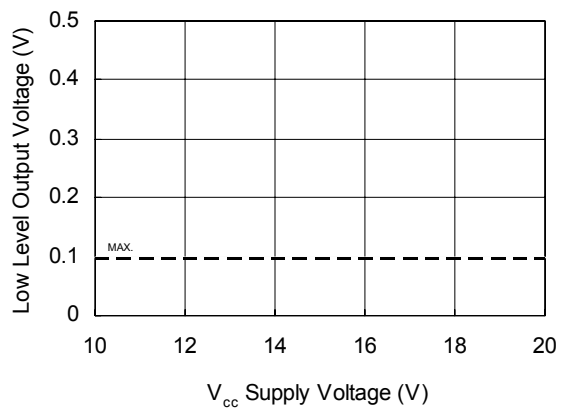

Figure 11B. Low Level Output vs. Supply Voltage

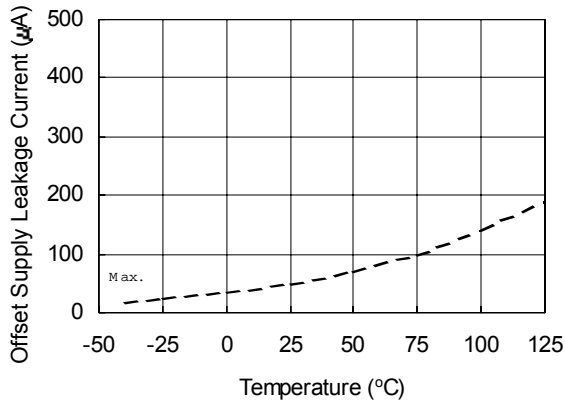

Figure 12A. Offset Supply Leakage Current vs. Temperature

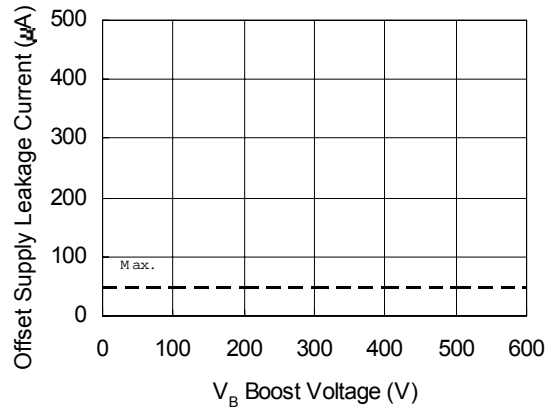

Figure 12B. Offset Supply Leakage Current vs. V_B Boost Voltage

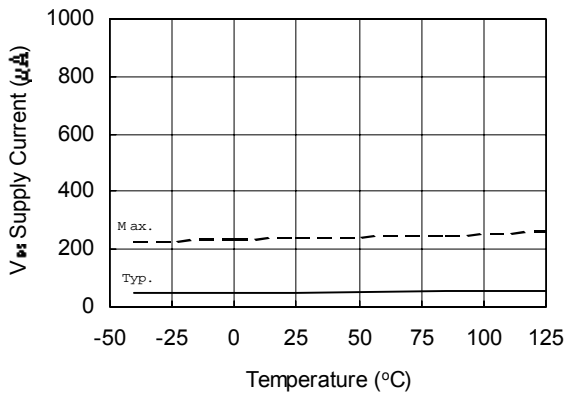

Figure 13A. V_{BS} Supply Current vs. Temperature

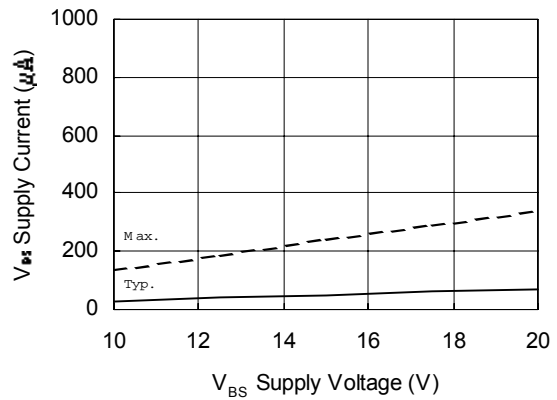

Figure 13B. V_{BS} Supply Current vs. Supply Voltage

IR2117(S)/IR2118(S) & (PbF)

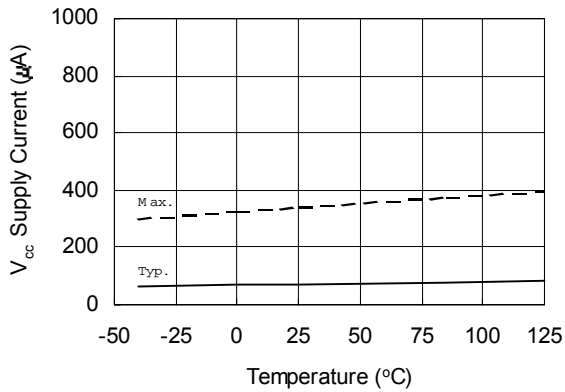

Figure 14A. V_{cc} Supply Current vs. Temperature

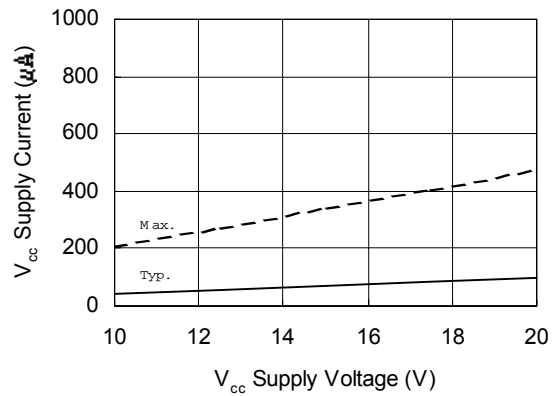

Figure 14B. V_{cc} Supply Current vs. Supply Voltage

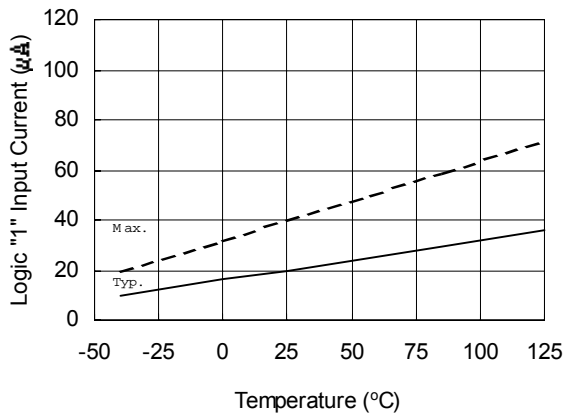

Figure 15A. Logic "1" (2118 "0") Input Current vs. Temperature

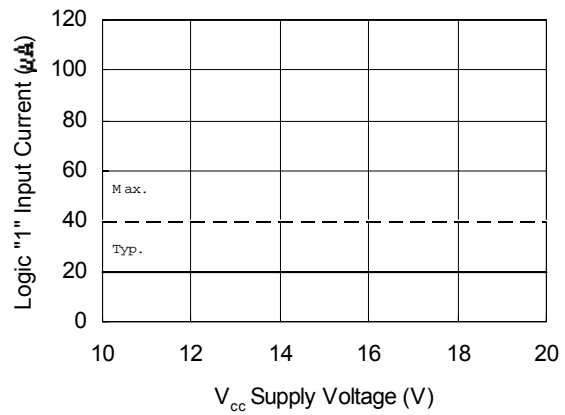

Figure 15B. Logic "1" (2118 "0") Input Current vs. Supply Voltage

IR2117(S)/IR2118(S) & (PbF)

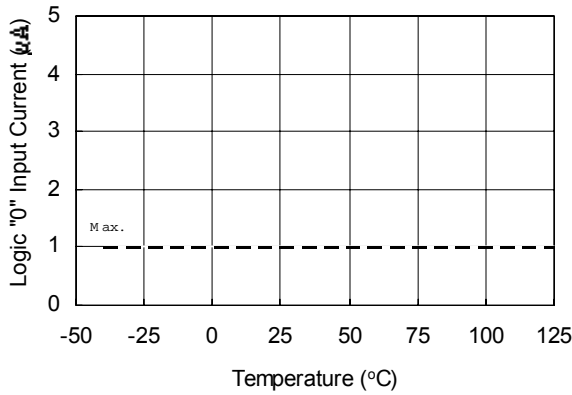

Figure 16A. Logic "0" (2118"1") Input Current vs. Temperature

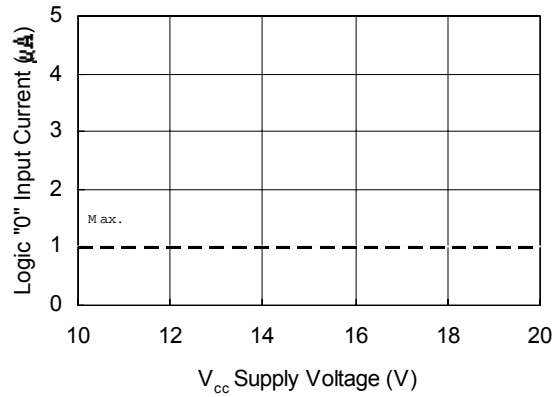

Figure 16B. Logic "0" (2118"1") Input Current vs. Supply Voltage

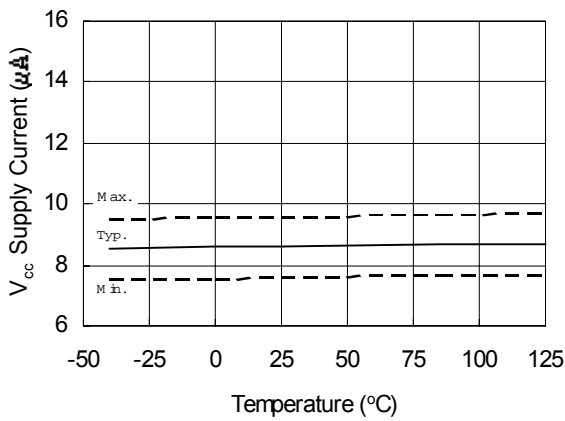

Figure 17A. V_{cc} Undervoltage Threshold (+) vs. Temperature

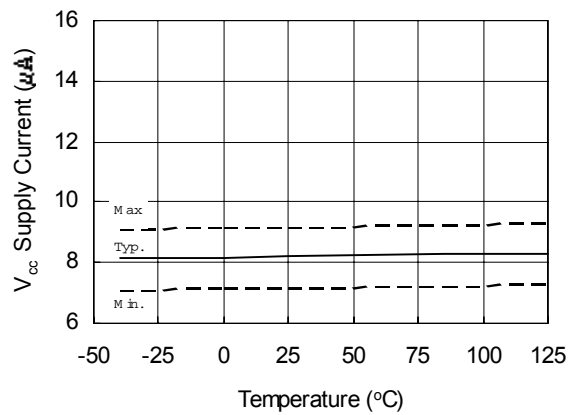

Figure 18A. V_{cc} Undervoltage Threshold (-) vs. Temperature

IR2117(S)/IR2118(S) & (PbF)

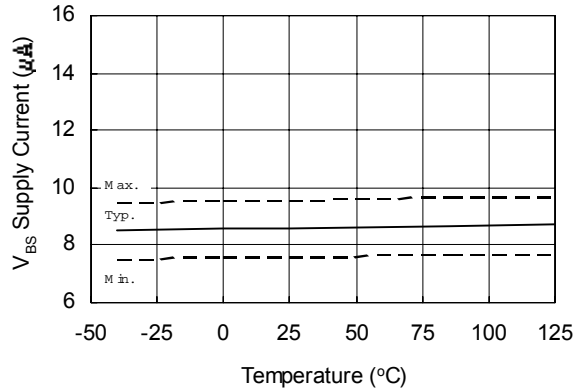

Figure 19A. V_{BS} Undervoltage Threshold (+) vs. Temperature

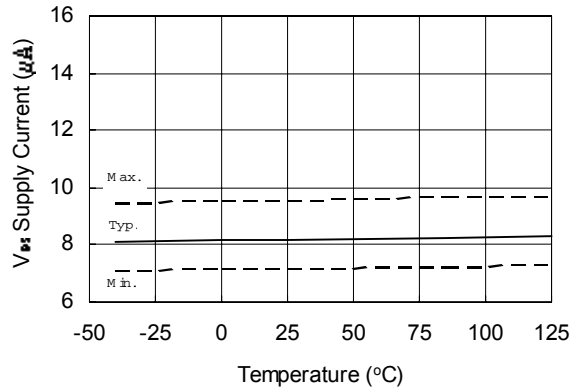

Figure 20A. V_{BS} Undervoltage Threshold (-) vs. Temperature

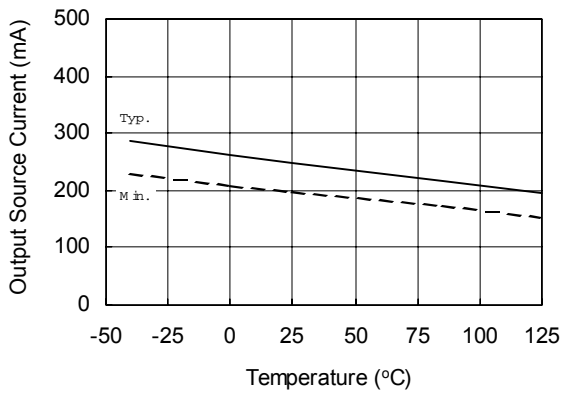

Figure 21A. Output Source Current vs. Temperature

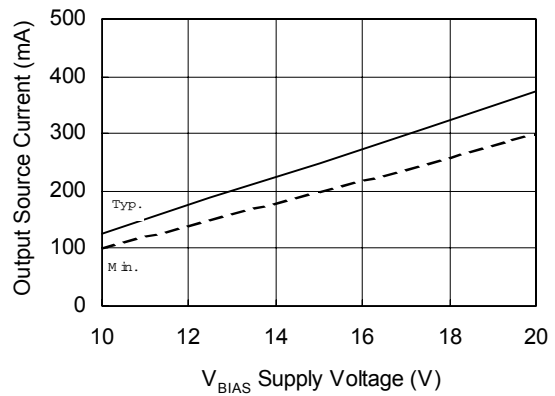

Figure 21B. Output Source Current vs. Supply Voltage

IR2117(S)/IR2118(S) & (PbF)

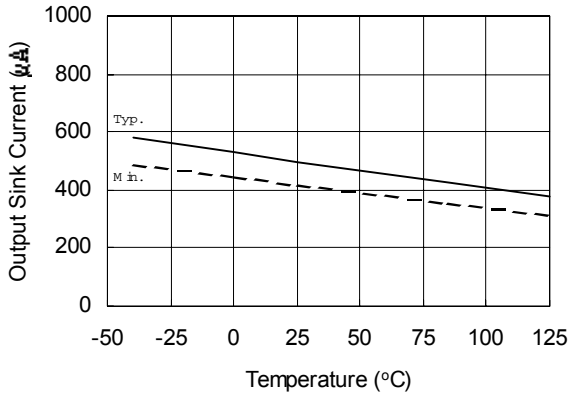

Figure 22A. Output Sink Current vs. Temperature

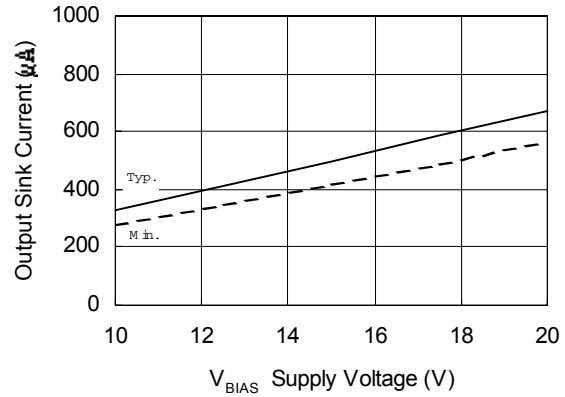

Figure 22B. Output Sink Current vs. Supply Voltage

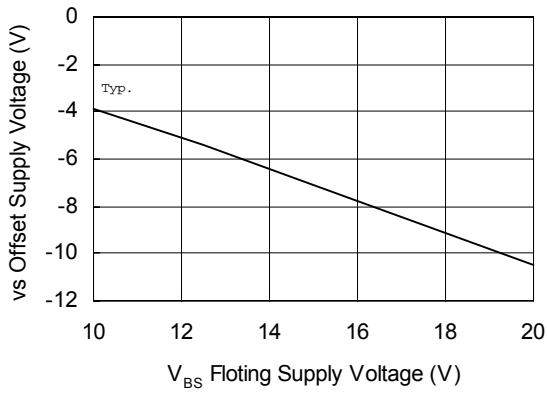

Figure 23B. Maximum VS Negative Offset vs. Supply Voltage

IR2117(S)/IR2118(S) & (PbF)

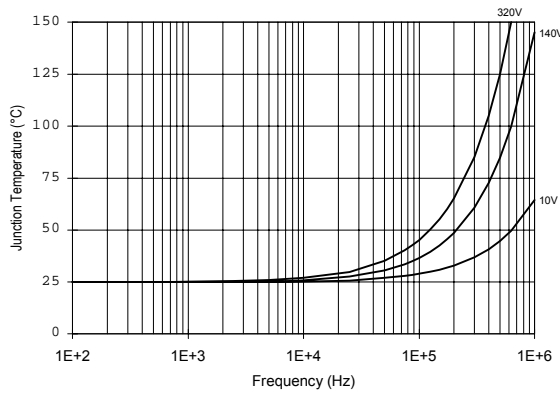

Figure 24. IR2117/IR2118 T_J vs. Frequency (IRFBC20)
 $R_{GATE} = 33\Omega$, $V_{CC} = 15V$

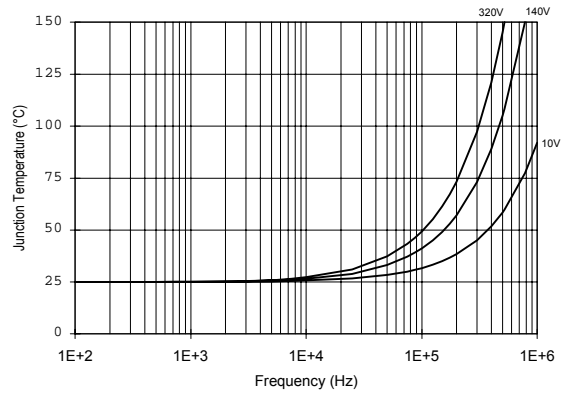

Figure 25. IR2117/IR2118 T_J vs. Frequency (IRFBC30)
 $R_{GATE} = 22\Omega$, $V_{CC} = 15V$

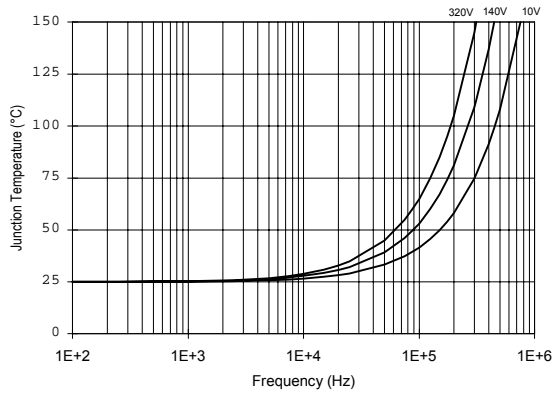

Figure 26. IR2117/IR2118 T_J vs. Frequency (IRFBC40)
 $R_{GATE} = 15\Omega$, $V_{CC} = 15V$

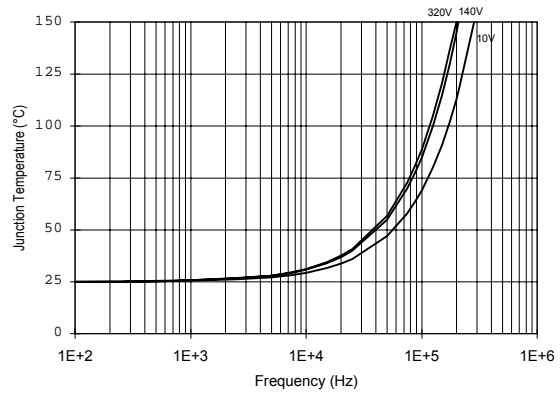
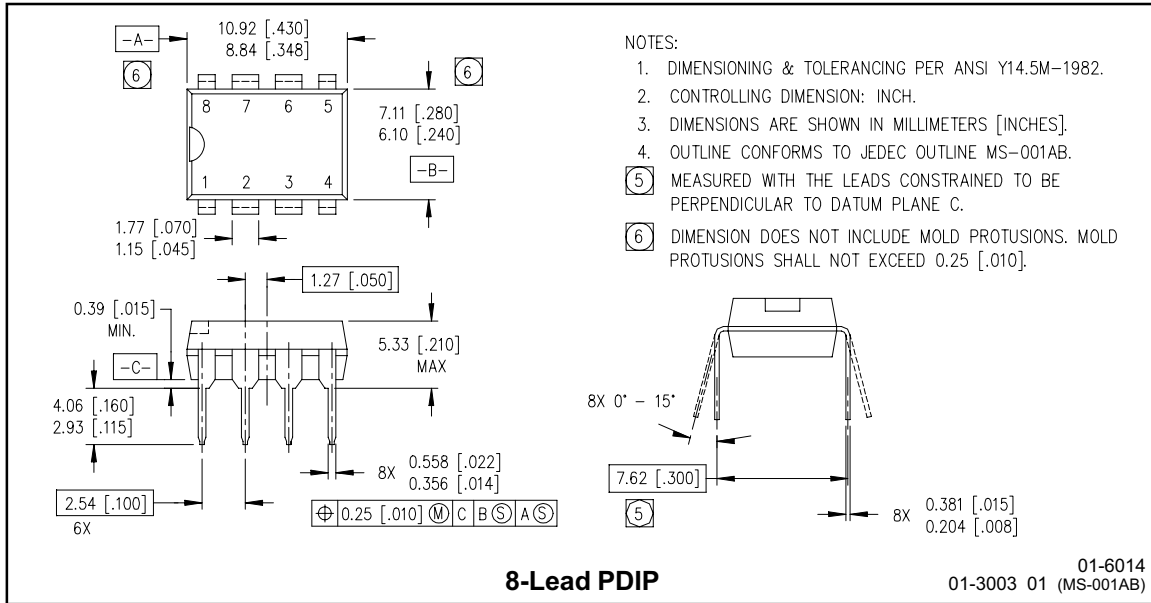

Figure 27. IR2117/IR2118 T_J vs. Frequency (IRFPE50)
 $R_{GATE} = 10\Omega$, $V_{CC} = 15V$

IR2117(S)/IR2118(S) & (PbF)

Case outlines



8-Lead PDIP

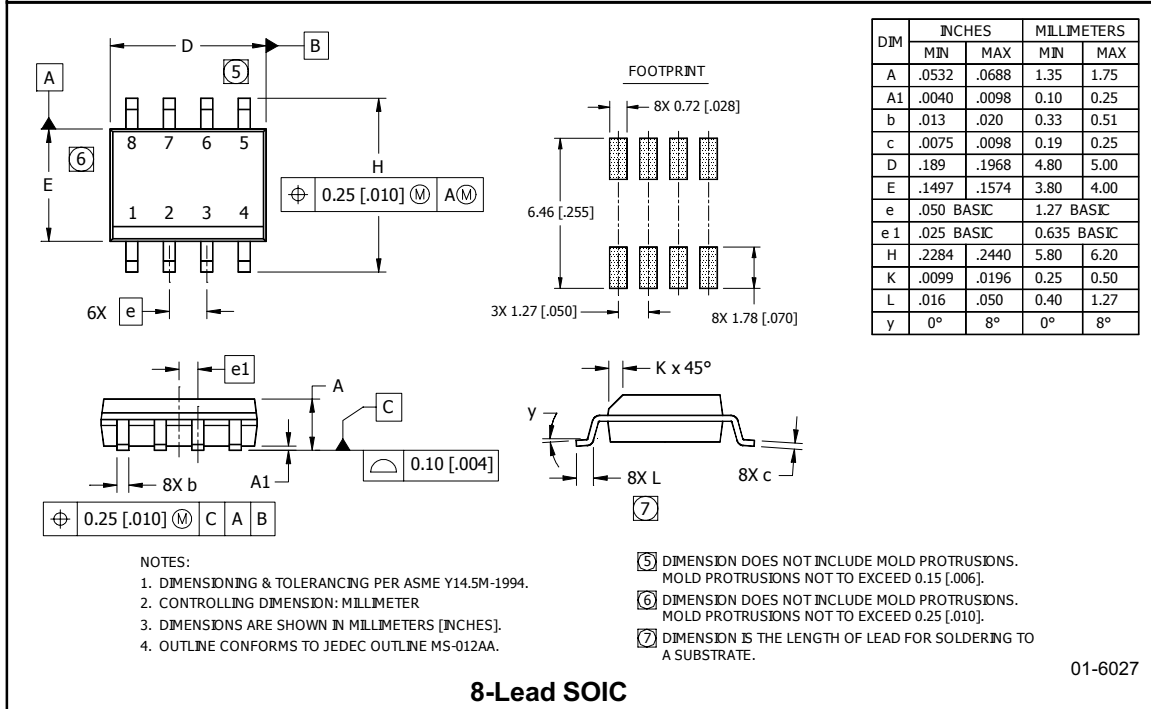

8-Lead SOIC

IR2117(S)/IR2118(S) & (PbF)

International
IR Rectifier

LEADFREE PART MARKING INFORMATION

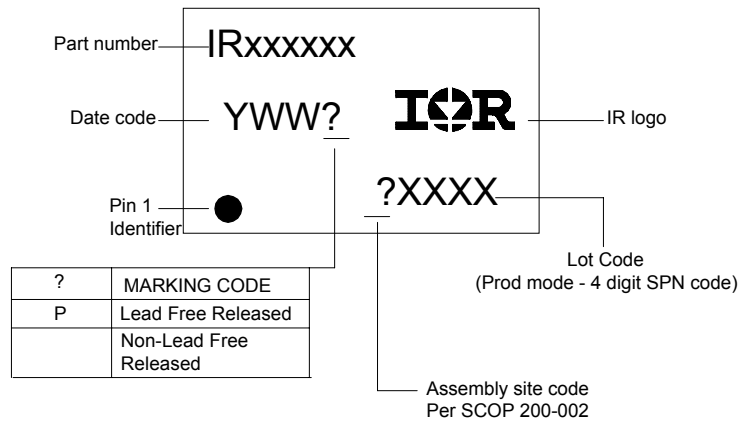

ORDER INFORMATION

Basic Part (Non-Lead Free)

8-Lead PDIP IR2117 order IR2117
 8-Lead PDIP IR2118 order IR2118
 8-Lead SOIC IR2117S order IR2117S
 8-Lead SOIC IR2118S order IR2118S

Leadfree Part

8-Lead PDIP IR2117 order IR2117PbF
 8-Lead PDIP IR2118 order IR2118PbF
 8-Lead SOIC IR2117S order IR2117SPbF
 8-Lead SOIC IR2118S order IR2118SPbF

International
IR Rectifier

IR WORLD HEADQUARTERS: 233 Kansas St., El Segundo, California 90245 Tel: (310) 252-7105
This product has been qualified per industrial level
 Data and specifications subject to change without notice. 5/14/2007