



HW: The Best Engineered Switch in the World

Key features include:

- Locking lever removable contact blocks
- Finger-safe IP20 contacts as standard, other terminal styles available
- Tamperproof construction
- All E-stops meet EN418 and are compliant with SEMI S2 standards
- Worldwide approvals
- Easy to assemble
- Available assembled or as sub-components
- Choice of black plastic or metallic front bezels
- Incandescent or LED illumination
- Transformer or full voltage
- Slow make double break self cleaning contacts

IDEC's HW switches are "The best engineered switch in the world" for a reason. Carrying the CE mark, UL, CSA, and TUV approvals, these switches are designed for use in almost any part of the world.

Complete with finger-safe contact blocks offering IP20 protection, these 7/8" (22mm) switches include illuminated and non-illuminated pushbuttons, pilot lights, selector switches, and emergency stop switches.

All switches also incorporate mechanically keyed safety locking levers, ensuring correct installation and maintaining safety in high-vibration applications.



File No. E68961



File No. LR92374









Registration No. R9551089 (E-stops)
 Registration No. J9551458 (all other switches)
 Registration No. J9650511 (Pilot Lights)

Conforming to Standards		EN60947-1, EN60947-5-1, VDE0660-200, UL508, CSA C22-2 No.14						
Approvals		File No. E68961 File No. LR92374 TÜV Rheinland Registration No. R9551089 (E-stops) Registration No. J9551458 (all other switches) Registration No. J9650511 (Pilot Lights)						
Operating Temperature		Operation: -25 to +50°C (without freezing) Storage: -40 to +70°C (without freezing)						
Vibration Resistance		10 to 55Hz, 98m/sec ² (10G) conforming to IEC6068-2-6						
Shock Resistance		980m/sec ² (100G) conforming to IEC6068-2-7						
Electric Shock Protection		Class 0 conforming to IEC60536						
Degree of Protection (conforming to IEC60529) (conforming to NEMA ICS6-110)		IP65 (from front of the panel) IP20 (Type HW-F contact block) NEMA 1, 2, 3, 3R, 3S, 4, 4X, 5, 12, 13 (from front of panel)						
Mechanical Life		Momentary pushbuttons: 5,000,000 (900 operations per hour) All other switches: 500,000						
Pollution Degree (conforming to IEC60947-1)		3 for switches not using a transformer 2 for switches using a transformer						
Rated Operational Characteristics		AC-15: A600 or Ue = 250V, Ie = 3A (NO, NC, NO-EM, NC-LB) DC-13: P600 or Ue = 125V, Ie = 1.1A (NO, NC) DC-13: Q600 or Ue = 125V, Ie = 0.9A (NO-EM, NC-LB)						
Rated Insulation Voltage		600V						
Rated Switching Over-Voltage		Less than 4kV, conforming to IEC60947-1						
Rated Impulse Withstanding Voltage		4kV for contact circuit 2.5kV for lamp circuit						
Rated Thermal Current		10 Amp						
Minimum Switching Capacity		5 mA at 3V AC/DC						
Contact Operation		Slow break NC or NO, self-cleaning						
Positive Action Operation (Emergency Stops with NC contacts)		5.5mm to 10mm travel to latch 45N minimum force to latch 10mm maximum travel 1,800 operations per hour maximum for a Pushlock Turn Reset 900 operations per hour maximum for a Push-Pull						
Operating Force		Flush and extended pushbuttons—with 1NO or 1NC contact: 6.2±2N (momentary), 7.0±2N (maintained) Additional contacts—1NO or 1NC: +3.2N (momentary), + 3.3N (maintained)						
Terminal Referencing		Conforming to CENELEC EN50005						
Recommended Terminal Torque		0.8 N m (7.1 in lb.)						
External Short-Circuit Protection		10A 250V fuse conforming to IEC60269-1						
Applicable Wire Size		Minimum 1 x 22 AWG, max. 2 x 14 AWG or 1 x 12 AWG						
Contact Resistance		Initial contact resistance of 50mΩ or less						
Contact Gap		4mm (NO and NC) 2mm (NO-EM and NC-LB)						
Horsepower Rating		Reference Value: 1/4 HP @ 120V (1ø non-reversing), 1HP @ 240V (3ø non-reversing)						
Electrical Reliability		MTBF < 1 fault for 10 million operation cycles (3V DC, 5mA)						
Lamp Ratings		Incandescent: 1 W LEDs: 6V/17mA max, 12V & 24V/11mA max, 120 & 240V/10mA max						
Maximum Inrush Current		40 A (40 ms)						
Contact Material		Silver (gold plated contacts available - contact IDEC)						
Contact Ratings	Break Values				Make Values			
	AC		DC		AC		DC	
	Inductive	Resistive	Inductive	Resistive	Inductive	Resistive	Inductive	Resistive
Rated Operating Current	24V:10A 120V: 5A 240V: 3A 480V: 1A	24V:10A 120V: 10A 240V: 6A 480V: 2A	24V: 5A 48V:2A 110V:1.1A 220V:0.6A	24V: 10A 48V:5A 110V:2.2A 220V:1.1A	120V: 60A 240V: 30A 480V: 15A 600V: 12 A	120V: 100A 240V: 60A 480V: 20A	120V: 11A 240V: 6A 12V: 40A 24V: 40A	120V: 20A 240V: 11A 480V: 4A 12V: 40A 24V: 40A

1. For dimensions, see page A-116.
2. For life expectancy derating curves, see page A-120.

Non-Illuminated Pushbuttons (Assembled)

Part Numbers: Non-Illuminated Pushbuttons

Style	Contact	Plastic Bezel		Metal Bezel	
		Momentary	Maintained	Momentary	Maintained
Round Flush 	1NO 1NC 1NO-1NC 2NO 2NC 2NO-2NC	HW1B-M1F10-① HW1B-M1F01-① HW1B-M1F11-① HW1B-M1F20-① HW1B-M1F02-① HW1B-M1F22-①	HW1B-A1F10-① HW1B-A1F01-① HW1B-A1F11-① HW1B-A1F20-① HW1B-A1F02-① HW1B-A1F22-①	HW4B-M1F10-① HW4B-M1F01-① HW4B-M1F11-① HW4B-M1F20-① HW4B-M1F02-① HW4B-M1F22-①	HW4B-A1F10-① HW4B-A1F01-① HW4B-A1F11-① HW4B-A1F20-① HW4B-A1F02-① HW4B-A1F22-①
Round Extended 	1NO 1NC 1NO-1NC 2NO 2NC 2NO-2NC	HW1B-M2F10-① HW1B-M2F01-① HW1B-M2F11-① HW1B-M2F20-① HW1B-M2F02-① HW1B-M2F22-①	HW1B-A2F10-① HW1B-A2F01-① HW1B-A2F11-① HW1B-A2F20-① HW1B-A2F02-① HW1B-A2F22-①	HW4B-M2F10-① HW4B-M2F01-① HW4B-M2F11-① HW4B-M2F20-① HW4B-M2F02-① HW4B-M2F22-①	HW4B-A2F10-① HW4B-A2F01-① HW4B-A2F11-① HW4B-A2F20-① HW4B-A2F02-① HW4B-A2F22-①
29mm Mushroom Head 	1NO 1NC 1NO-1NC 2NO 2NC 2NO-2NC	HW1B-M3F10-① HW1B-M3F01-① HW1B-M3F11-① HW1B-M3F20-① HW1B-M3F02-① HW1B-M3F22-①	HW1B-A3F10-① HW1B-A3F01-① HW1B-A3F11-① HW1B-A3F20-① HW1B-A3F02-① HW1B-A3F22-①	HW4B-M3F10-① HW4B-M3F01-① HW4B-M3F11-① HW4B-M3F20-① HW4B-M3F02-① HW4B-M3F22-①	HW4B-A3F10-① HW4B-A3F01-① HW4B-A3F11-① HW4B-A3F20-① HW4B-A3F02-① HW4B-A3F22-①
40mm Mushroom Head 	1NO 1NC 1NO-1NC 2NO 2NC 2NO-2NC	HW1B-M4F10-① HW1B-M4F01-① HW1B-M4F11-① HW1B-M4F20-① HW1B-M4F02-① HW1B-M4F22-①	HW1B-A4F10-① HW1B-A4F01-① HW1B-A4F11-① HW1B-A4F20-① HW1B-A4F02-① HW1B-A4F22-①	HW4B-M4F10-① HW4B-M4F01-① HW4B-M4F11-① HW4B-M4F20-① HW4B-M4F02-① HW4B-M4F22-①	HW4B-A4F10-① HW4B-A4F01-① HW4B-A4F11-① HW4B-A4F20-① HW4B-A4F02-① HW4B-A4F22-①
60mm Jumbo Mushroom Head 	1NO 1NC 1NO-1NC 2NO 2NC 2NO-2NC	HW1B-M5F10-①* HW1B-M5F01-①* HW1B-M5F11-①* HW1B-M5F20-①* HW1B-M5F02-①* HW1B-M5F22-①*	—	—	—
Square Flush 	1NO 1NC 1NO-1NC 2NO 2NC 2NO-2NC	HW2B-M1F10-① HW2B-M1F01-① HW2B-M1F11-① HW2B-M1F20-① HW2B-M1F02-① HW2B-M1F22-①	HW2B-A1F10-① HW2B-A1F01-① HW2B-A1F11-① HW2B-A1F20-① HW2B-A1F02-① HW2B-A1F22-①	—	—
Square Extended 	1NO 1NC 1NO-1NC 2NO 2NC 2NO-2NC	HW2B-M2F10-① HW2B-M2F01-① HW2B-M2F11-① HW2B-M2F20-① HW2B-M2F02-① HW2B-M2F22-①	HW2B-A2F10-① HW2B-A2F01-① HW2B-A2F11-① HW2B-A2F20-① HW2B-A2F02-① HW2B-A2F22-①	—	—

① Button Color Code

Color	Code
Black	B
Green	G
Red	R
Blue	S
White	W
Yellow	Y
Grey	N*

* Grey is available for Round Flush models only.



- In place of ①, specify the Button Color Code.
- * Jumbo mushroom available only in red, green, black, and yellow.
- For nameplates and accessories, see page A-113 and A-115.
- For dimensions, see page A-116.
- For sub-assembly part numbers, see page A-79.

Non-Illuminated Pushbuttons (Partial-Assemblies)

Contact Assembly + Operator Assembly + Complete Switch



Switches & Pilot Devices

Part Numbers: Operator Assemblies

Style		Plastic Bezel	Metal Bezel
	Momentary	HW1B-M1-①	HW4B-M1-①
	Maintained	HW1B-A1-①	HW4B-A1-①
	Momentary	HW1B-M2-①	HW4B-M2-①
	Maintained	HW1B-A2-①	HW4B-A2-①
	Momentary	HW1B-M3-①	HW4B-M3-①
	Maintained	HW1B-A3-①	HW4B-A3-①
	Momentary	HW1B-M4-①	HW4B-M4-①
	Maintained	HW1B-A4-①	HW4B-A4-①
	Momentary	HW1B-M5-①*	—

Style		Plastic Bezel	Metal Bezel
	Momentary	HW2B-M1-①	—
	Maintained	HW2B-A1-①	—
	Momentary	HW2B-M2-①	—
	Maintained	HW2B-A2-①	—

- 1. In place of ①, specify the Button Color Code from table below.
- 2. *60mm mushroom available in red, green, black and yellow only.
- 3. For complete sub-assemblies, see page A-79.

Part Numbers: Contact Assemblies

Style	Contacts	Part Number
	1NO 1NC 1NO/1NC 2NO 2NC 2NO/2NC	HW-CBF10 HW-CBF01 HW-CBF11 HW-CBF20 HW-CBF02 HW-CBF22
	1NO 1NC 1NO/1NC 2NO 2NC 2NO/2NC	HW-CB10 HW-CB01 HW-CB11 HW-CB20 HW-CB02 HW-CB22

① Button Color Code

Color	Code
Black	B
Green	G
Red	R
Blue	S
White	W
Yellow	Y
Grey	N*

*Grey is available for round flush only.

Non-Illuminated Pushbuttons (Sub-Assembled)

Contact Blocks + Adaptor & Safety Lever Lock + Anti-Rotation Ring + Operator + Button = Complete Part



Part Numbers: Operators

Style		Plastic Bezel	Metal Bezel
Round Flush/Extended			
	Momentary	HW1B-M0	HW4B-M0
	Maintained	HW1B-A0	HW4B-A0
Ø 29mm Mushroom Ø 40mm Mushroom			
	Momentary	HW1B-M0L	HW4B-M0L
	Maintained	HW1B-A0L	HW4B-A0L
Ø 60mm Jumbo Mushroom			
	Momentary	HW1B-M5-①*	-
Square Flush Extended			
	Momentary	HW2B-M0	-
	Maintained	HW2B-A0	-



- In place of ①, specify the Button Color Code from table below.
- *60mm mushroom operator includes non-removable button (available in red, black, green and yellow only).
- For nameplates and accessories, see page A-113.
- For dimensions, see page A-116.

① Button Color Code

Color	Code	Color	Code
Black	B	White	W
Green	G	Yellow	Y
Red	R	Grey	N [†]
Blue	S		



- HW1B-M5 available only in black, red green and yellow.
- [†] Grey available for round flush only.

Part Numbers: Contact Blocks

Style	1N0	1NC
Standard Fingersafe Contacts (IP20)	HW-F10 HW-F10R (early make)	HW-F01 HW-F01R (late break)
Spring-Up Terminal Contacts	HW-G10 HW-G10R (early make)	HW-G01 HW-G01R (late break)
Exposed Screw Terminal Contacts	HW-C10 HW-C10R (early make)	HW-C01 HW-C01R (late break)
Dummy Block	TW-DB	



- All assembled part numbers in catalog include standard (HW-F...) contacts.
- Assembled units with spring-up terminals (HW-G...) can be ordered by removing an "F" from the part number (Ex. HW1B-M1F11-R becomes HW1B-M111-R).
- Units with exposed screw terminals (HW-C...) must be ordered as sub-components.
- All contacts (including non-fingersafe versions) are UL, CSA, and IEC compliant and carry the CE mark.

Part Numbers: Anti-Rotation Ring

Appearance	Part Number
	HW9Z-RL



Use with notched panel cutout to prevent unit rotation.

Part Numbers: Buttons

Style	Part Number
Round Flush	HW1A-B1-①
Round Extended	HW1A-B2-①
Ø 29mm Mushroom Cap	HW1A-B3-①
Ø 40mm Mushroom Cap	HW1A-B4-①
Square Flush	HW2A-B1-①
Square Extended	HW2A-B2-①

Part Number: Contact Block Mounting Adaptor (safety lever lock included)

Style	Part Number
	HW-CB2C



- Used to mount contact blocks to operator (first pair only).
- IDEC strongly recommends using the safety lever lock (included) to prevent heavy vibration or maintenance personnel from inadvertently unlocking contacts.

Emergency Stop Pushbuttons (Assembled)

Part Numbers: Non-Illuminated Emergency Stop Pushbuttons

Style	Contact	Plastic Bezel	Metal Bezel
 ø 40mm Head Push-Pull	1NO 1NC 1NO-1NC 2NC 2NO	HW1B-Y2F10-①† HW1B-Y2F01-①† HW1B-Y2F11-①† HW1B-Y2F02-①† HW1B-Y2F20-①†	HW4B-Y2F10-①† HW4B-Y2F01-①† HW4B-Y2F11-①† HW4B-Y2F02-①† HW4B-Y2F20-①†
 ø 29mm Head Pushlock Turn Reset	1NO 1NC 1NO-1NC 2NO 2NC	HW1B-V3F10-R* HW1B-V3F01-R* HW1B-V3F11-R* HW1B-V3F20-R* HW1B-V3F02-R*	HW4B-V3F10-R* HW4B-V3F01-R* HW4B-V3F11-R* HW4B-V3F20-R* HW4B-V3F02-R*
 ø 40mm Head Pushlock Turn Reset	1NO 1NC 1NO-1NC 2NO 2NC	HW1B-V4F10-①† HW1B-V4F01-①† HW1B-V4F11-①† HW1B-V4F20-①† HW1B-V4F02-①†	HW4B-V4F10-①† HW4B-V4F01-①† HW4B-V4F11-①† HW4B-V4F20-①† HW4B-V4F02-①†
 ø 40mm Head EMO Pushlock Turn Reset	1NO 1NC 1NO-1NC 2NO 2NC	HW1B-V4F10-R-EMO HW1B-V4F01-R-EMO HW1B-V4F11-R-EMO HW1B-V4F20-R-EMO HW1B-V4F02-R-EMO	HW4B-V4F10-R-EMO HW4B-V4F01-R-EMO HW4B-V4F11-R-EMO HW4B-V4F20-R-EMO HW4B-V4F02-R-EMO
 ø 40mm Head Pushlock Key Reset	1NO 1NC 1NO-1NC 2NO 2NC	HW1B-X4F10-R* HW1B-X4F01-R* HW1B-X4F11-R* HW1B-X4F20-R* HW1B-X4F02-R*	HW4B-X4F10-R* HW4B-X4F01-R* HW4B-X4F11-R* HW4B-X4F20-R* HW4B-X4F02-R*
 ø 60mm Head Pushlock Turn Reset	1NO 1NC 1NO-1NC 2NO 2NC	HW1B-V5F10-R* HW1B-V5F01-R* HW1B-V5F11-R* HW1B-V5F20-R* HW1B-V5F02-R*	-
 ø 40mm Head Unibody Pushlock Turn Reset	1NO-1NC 2NC 1NO-2NC	HW1E-BV4F11-R* HW1E-BV4F02-R* HW1E-BV412R-TK2093-1**	-

Part Numbers: Non-Illuminated Emergency Stop Pushbuttons

Style	Illumination Type	Contact	Part Number
	LED	1NO-1NC 2NC 2NC (with active lamp circuit) 1NO-1NC (with active lamp circuit)	HW1E-LV4F11QD-R*-③ HW1E-LV4F02QD-R*-③ HW1E-TV4F02QD-R-③ HW1E-TV4F11QD-R*-③
	Incandescent	1NO-1NC 2NC 1NO-1NC (with active lamp circuit) 2NC (with active lamp circuit)	HW1E-LV4F11Q-R*-③ HW1E-LV4F02Q-R*-③ HW1E-TV4F11Q-R*-③ HW1E-TV4F02Q-R*-③

Part Numbers: Nameplates

HWAV-Yellow Plastic

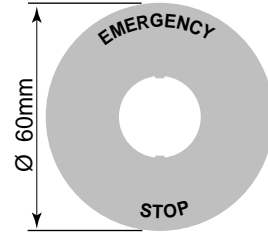

Style	Part Number
60mm Diameter "Emergency Stop"	HWAV-27†
60mm Diameter Blank	HWAV-0Y
80mm Diameter "Emergency Stop" (for jumbo mushroom use)	HWAV-527



† HWAV-27 comes marked "Emergency Stop" as shown in drawing.

Part Numbers: E-Stop Shrouds

Style	Part Number
	HW9Z-KG1-TK2120
	HW9Z-KG2-TK2120



Not applicable for 60mm mushroom.

Terminal Numbering (Unibody only)

Models	Terminal Number
1NO-1NC	NO = .3/.4, NC = .1/.2
2NC	NC = 11/12, NC = 21/22
HW1E-L HW1E-T	Lamp + = X2, Lamp - = X1



- * Available in Red only.
- † Available in red or yellow (insert color code in place of ①)
- In place of ③, specify Full Voltage Code.
- With single unit construction, the positive action contacts are integrated in the body of the switch. This provides an extra degree of safety and reliability for critical emergency stop functions.
- In the illuminated version, the light is independent of the switch action (except active lamp circuit model).
- For nameplates and accessories, see page A-113.
- For dimensions, see page A-116.
- For sub-assembly part numbers, see next page.
- All HW series E-stops comply with EN418, the IEC "E-Stop Addendum to the Low Voltage Directive," this includes "tamper proof" operation whereby a change of contact state is not possible by "teasing" or "floating" the operator.
- "Active Lamp Circuit" consists of a built-in Normally Open contact in series with the lamp. This allows the lamp to illuminate only when the button is pressed and eliminates the need for external jumpering.

③ Full Voltage Code

Voltage	Code
6VAC/DC	6V
12VAC/DC	12V
24VAC/DC	24V

Emergency Stop Pushbuttons (Partial-Assemblies)

Contact Assembly + Anti-Rotation Ring + Operator Assembly + Complete Switch



Part Numbers: Operators

Style		Plastic Bezel	Metal Bezel
Ø 29mm Head Pushlock Turn Reset 		HW1B-V3R*	HW4B-V3R*
Ø 40mm Head Pushlock Turn Reset 	red	HW1B-V4R	HW4B-V4R
	yellow	HW1B-V4Y	HW4B-V4Y
Ø 40mm Head EMO Pushlock Turn Reset 		HW1B-V4R-EMO-2*	HW4B-V4R-EMO-2*
Ø 40mm Head Push-Pull 	red	HW1B-Y2R	HW4B-Y2R
	yellow	HW1B-Y2Y	HW4B-Y2Y
Ø 40mm Head Pushlock Key Reset 		HW1B-X4R*	HW4B-X4R*
Ø 60mm Head Pushlock Turn Reset 		HW1B-V5R	—

Part Numbers: Anti-Rotation Ring

Appearance	Part Number
	HW9Z-RL



Use with notched panel cutout to prevent unit rotation.



- *Available in red only.
- All HW Series Emergency Stop operators include non-removable color caps.
- All HW Series Emergency Stop operators comply with EN418 "E-Stop Addendum to the Low Voltage Directive" (when used as part of a complete HW series Emergency Stop Pushbutton).
- All HW series Emergency Stop switches comply with SEMI S2 standards.

Part Numbers: Contact Assemblies

Style	Contacts	Part Number
Standard Fingersafe Contacts 	1NO 1NC 1NO/1NC 2NO 2NC 2NO/2NC	HW-CBF10 HW-CBF01 HW-CBF11 HW-CBF20 HW-CBF02 HW-CBF22
Spring Up Terminal Contacts 	1NO 1NC 1NO/1NC 2NO 2NC 2NO/2NC	HW-CB10 HW-CB01 HW-CB11 HW-CB20 HW-CB02 HW-CB22



Gold contact option is available for spring-up terminals. Add suffix "MAU" to end of part number. For example, HW-CB20 becomes HW-CB20-MAU.

Emergency Stop Pushbuttons (Sub-Assembled)

Contact Blocks + Adaptor & Safety Lever Lock + Anti-Rotation Ring + Operator = Complete Part



Switches & Pilot Devices

Part Numbers: Emergency Stop Operators

Style		Plastic	Metal
 Ø 29mm Head Pushlock Turn Reset		HW1B-V3R*	HW4B-V3R*
 Ø 40mm Head Pushlock Turn Reset	red	HW1B-V4R	HW4B-V4R
	yellow	HW1B-V4Y	HW4B-V4Y
 Ø 40mm Head EMO Pushlock Turn Reset		HW1B-V4R-EMO-2*	HW4B-V4R-EMO-2*
 Ø 40mm Head Push-Pull	red	HW1B-Y2R	HW4B-Y2R
	yellow	HW1B-Y2Y	HW4B-Y2Y
 Ø 40mm Head Pushlock Key Reset		HW1B-X4R*	HW4B-X4R*
 Ø 60mm Head Pushlock Turn Reset		HW1B-V5R	-

- 1. *Available in red only.
- 2. All Emergency Stop Buttons are non-removable from the operator.

Part Number: Contact Block Mounting Adaptor (safety lever lock included)

Style	Part Number
	HW-CB2C

- 1. Used to mount contact blocks to operator (first pair only).
- 2. IDEC strongly recommends using the safety lever lock (included) to prevent heavy vibration or maintenance personnel from unlocking contacts.

Part Numbers: Contact Blocks

Description	Part Number	
	1NO	1NC
 Standard Fingersafe (IP20)	HW-F10 HW-F10R (early make)	HW-F01 HW-F01R (late break)
 Spring-Up Terminal Contacts	HW-G10 HW-G10R (early make) HW-G10-MAU (gold contacts)	HW-G01 HW-G01R (late break) HW-G01-MAU (gold contacts)
 Exposed Screw Terminal Contacts	HW-C10 HW-C10R (early make)	HW-C01 HW-C01R (late break)
 Dummy Block	TW-DB	

- 1. All assembled part numbers in catalog include standard (HW-F..) contacts. (except unibody)
- 2. Assembled units with spring-up terminals (HW-G...) can be ordered by removing an "F" from the part number (Ex. HW1B-M1F11-R becomes HW1B-M111-R).
- 3. Units with exposed screw terminals (HW-C...) must be ordered as sub-components.
- 4. All contacts (including exposed screw) are UL, CSA, and IEC compliant and carry the CE mark.

Part Numbers: Anti-Rotation Ring

Appearance	Part Number
	HW9Z-RL

- Use with notched panel cutout to prevent unit rotation.

Emergency Stop Stations

Part Numbers: Emergency Stop Stations

Description	Contacts	Plastic Bezel	Metal Bezel
Ø 40mm Pushlock Turn Reset	1NO-1NC	HW1X-BV411-R*	HW4X-BV411-R*
	2NC	HW1X-BV402-R*	HW4X-BV402-R*
Ø 29mm Pushlock Turn Reset	1NO-1NC	HW1X-BV311-R*	HW4X-BV311-R*
	2NC	HW1X-BV302-R*	HW4X-BV302-R*
Ø 40mm Push-Pull Reset	1NO-1NC	HW1X-BY411-R*	HW4X-BY411-R*
	2NC	HW1X-BY402-R*	HW4X-BY402-R*
Ø 40mm Pushlock Key Reset	1NO-1NC	HW1X-BX411-R*	HW4X-BX411-R*
	2NC	HW1X-BX402-R*	HW4X-BX402-R*



1. * Available in Red only.
2. Maximum of two contact blocks.
3. Available as completed unit only.
4. Box is supplied with yellow top and black bottom only.



Part Numbers: Nameplates for Emergency Stop Stations

NSA-Aluminum	Color	Part Number	
		Blank	Engraved
	Black	NSA-OB	NSA-*
	Red	NSA-OR	NSA-*R



1. In place of * please insert the word, letters, or numbers you would like engraved. For standard engravings, see page A-113.
2. For specifications on engravings, please consult factory.

Part Numbers: Base Mount Contact Blocks

Configuration	Part Number
1NO	HW-S10
1NC	HW-S01

Part Numbers: Plug Adaptors

Type	Part Number
G1/2	HW9Z-G
PG16	HW9Z-PG



Panel Mount Dimensions

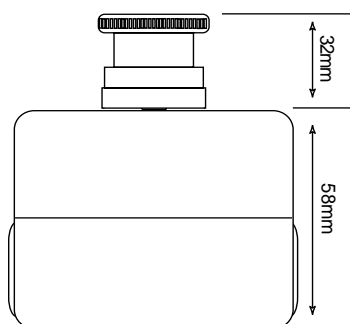
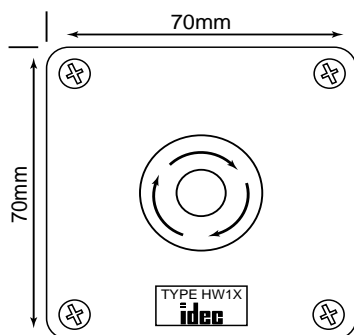

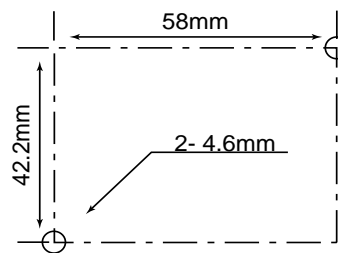

Panel Mount Dimensions



Pilot Lights (Assembled)

Part Numbers: LED Pilot Lights

Style			Plastic Bezel	Metal Bezel
Round Flush  (HW1P-1FQD shown)	Full Voltage		HW1P-1FQD-②-③	HW4P-1FQD-②-③
	Transformer	120V AC 240V AC 480V AC	HW1P-1FH2D-② HW1P-1FM4D-② HW1P-1FT8D-②	HW4P-1FH2D-② HW4P-1FM4D-② HW4P-1FT8D-②
Dome  (HW1P-2FQD shown)	Full Voltage		HW1P-2FQD-②-③	HW4P-2FQD-②-③
	Transformer	120V AC 240V AC 480V AC	HW1P-2FH2D-② HW1P-2FM4D-② HW1P-2FT8D-②	HW4P-2FH2D-② HW4P-2FM4D-② HW4P-2FT8D-②
Square Flush  (HW2P-1FH2D shown)	Full Voltage		HW2P-1FQD-②-③	—
	Transformer	120V AC 240V AC 480V AC	HW2P-1FH2D-② HW2P-1FM4D-② HW2P-1FT8D-②	—

② Lens/LED Color Code

Color	Code
Amber	A
Green	G
Red	R
Blue	S
White	W
Yellow	Y





- In place of ②, specify the Lens/LED Color Code, in place of ③ specify the Full Voltage Code from table below.
- Other voltages available, contact IDEC for details.
- For nameplates and accessories, see page A-113.
- For dimensions, see page A-116.

③ Full Voltage Code

Voltage	Code
6V AC/DC	6
12V AC/DC	12
24V AC/DC	24
120V AC (LED only)	120
240VAC (LED only)	240

Part Numbers: Incandescent Pilot Lights

Style			Plastic Bezel	Metal Bezel
Round Flush  (HW1P-1FQ shown)	Full Voltage		HW1P-1FQ-②-③	HW4P-1FQ-②-③
	Transformer	120V AC 240V AC 480V AC	HW1P-1FH2-② HW1P-1FM4-② HW1P-1FT8-②	HW4P-1FH2-② HW4P-1FM4-② HW4P-1FT8-②
	DC-DC Converter	110V DC	HW1P-1D2D-②	HW4P-1D2D-②
Dome  (HW1P-2FQ shown)	Full Voltage		HW1P-2FQ-②-③	HW4P-2FQ-②-③
	Transformer	120V AC 240V AC 480V AC	HW1P-2FH2-② HW1P-2FM4-② HW1P-2FT8-②	HW4P-2FH2-② HW4P-2FM4-② HW4P-2FT8-②
	DC-DC Converter	110V DC	HW1P-2D2D0-②	HW4P-2D2D-②
Square Flush  (HW2P-1FQ shown)	Full Voltage		HW2P-1FQ-②-③	—
	Transformer	120V AC 240V AC 480V AC	HW2P-1FH2-② HW2P-1FM4-② HW2P-1FT8-②	—
	DC-DC Converter	110V DC	HW2P-1D2D-②	—



- In place of ②, specify the Lens Color Code.
- In place of ③ specify the Full Voltage Code from tables below.
- Other voltages available, contact IDEC for details.
- DC-DC converter voltage input from 90-140V DC.

Pilot Lights (Partial-Assemblies)

Full Voltage Models



Operator/Lens + Lamp + Complete Pilot Light



Part Numbers: Operator/Lens

Style	Plastic Bezel	Metal Bezel
Round Flush 	HW1P-1FQ0-②	HW4P-1FQ0-②
Dome 	HW1P-2FQ0-②	HW4P-2FQ0-②
Square Flush 	HW2P-1FQ0-②	—

Part Numbers: Lamps

Type	Voltage	Part Number
LED 	6V AC/DC	LSTD-6②
	12V AC/DC	LSTD-1②
	24V AC/DC	LSTD-2②
	120V AC	LSTD-H2②
Incandescent 	240V AC	LSTD-M4②
	6.3V AC/DC	IS-6
	12V AC/DC	IS-12
	24V AC/DC	IS-24
	30V AC/DC	IS-30



In place of ②, specify the Lens Color Code from table on previous page.



- In place of ②, specify the LED Color Code from table on previous page.
- The LED contains a current-limiting resistor and reverse polarity protection diodes.

Transformer Models

Transformer/Lamp + Operator/Lens + Complete



Part Numbers: Operator/Lens

Style	Plastic Bezel	Metal Bezel
Round Flush 	HW1P-1F0-②	HW4P-1F0-②
Dome 	HW1P-2F0-②	HW4P-2F0-②
Square Flush 	HW2P-1F0-②	—

Part Numbers: Transformer/Lamp

Voltage	Part Number
120V AC with LED	HW-FH2-②
240V AC with LED	HW-FM4-②
480V AC with LED	HW-FT8-②
120V AC with Incandescent	HW-FH2
240V AC with Incandescent	HW-FM4
480V AC with Incandescent	HW-FT8
110V DC with LED	HW-RDD-②



In place of ②, specify the Lens Color Code from table on previous page.



- In place of ②, specify the LED Color Code from table on previous page.
- All transformers have a 6V AC secondary voltage.
- LED/Lamp supplied with transformer partial assembly.

Pilot Lights (Sub-Assembled)

Transformer* + Lamp + Anti-Rotation Ring + Operator + Lens = Complete Part

A

Switches & Pilot Devices



* Not applicable to full voltage units.

Part Numbers: Operators

Style	Type	Plastic Bezel	Metal Bezel
 (HW1P-10 shown)	Full Voltage	HW1P-1FQ0	HW4P-1FQ0
		HW1P-1Q0 (with spring up terminals)	HW4P-1Q0 (with spring up terminals)
 (HW1P-20 shown)	Full Voltage	HW1P-2FQ0	HW4P-2FQ0
		HW1P-2Q0 (with spring up terminals)	HW4P-2Q0 (with spring up terminals)
 (HW2P-10 shown)	Full Voltage	HW2P-1FQ0	—
		HW2P-1Q0 (with spring up terminals)	—
	Transformer	HW1P-10	HW4P-10
		HW2P-10	HW4P-20

- 1. Transformer type requires separate transformer & lamp.
- 2. Full voltage type only requires lamp.

Part Numbers: Transformer Units

Style	Voltage	Part Number
 (6V secondary voltage)	120V AC	HW-FH20 HW-MH20 (with spring up)
	240V AC	HW-FM40 HW-MM40 (with spring up)
	480V AC	HW-FT80 HW-RT80 (with spring up)
	110V DC	HW-RD0

Part Numbers: Lamps

Type	Voltage	Part Number
	6V AC/DC	LSTD-6 ^②
	12V AC/DC	LSTD-1 ^②
	24V AC/DC	LSTD-2 ^②
	120V AC	LSTD-H2 ^②
	240V AC	LSTD-M4 ^②
	6.3V AC/DC	IS-6
	12V AC/DC	IS-12
	24V AC/DC	IS-24

- 1. In place of ^②, specify the LED Color Code.
- 2. The LED contains a current-limiting resistor and reverse polarity protection diodes.

Part Numbers: Anti-Rotation Ring

Appearance	Part Number
	HW9Z-RL

- Use with notched panel cutout to prevent unit rotation.

Part Numbers: Lenses

Style	Part Number
	HW1A-P1- ^②
	HW1A-P2- ^②
	HW2A-P1- ^②

- In place of ^②, specify the Lens Color Code.

^② Lens/LED Color Code

Color	Code
Amber	A
Green	G
Red	R
Blue	S
White	W
Yellow	Y

Illuminated Pushbuttons (Assembled)

Part Numbers: Illuminated Pushbuttons

Style	Description	Contacts	Plastic Bezel		Metal Bezel	
			Momentary	Maintained	Momentary	Maintained
Flush 	Full Voltage	1NO 1NC 1NO-1NC 2NO	HW1L-M1F10Q ^{④-②-③} HW1L-M1F01Q ^{④-②-③} HW1L-M1F11Q ^{④-②-③} HW1L-M1F20Q ^{④-②-③}	HW1L-A1F10Q ^{④-②-③} HW1L-A1F01Q ^{④-②-③} HW1L-A1F11Q ^{④-②-③} HW1L-A1F20Q ^{④-②-③}	HW4L-M1F10Q ^{④-②-③} HW4L-M1F01Q ^{④-②-③} HW4L-M1F11Q ^{④-②-③} HW4L-M1F20Q ^{④-②-③}	HW4L-A1F10Q ^{④-②-③} HW4L-A1F01Q ^{④-②-③} HW4L-A1F11Q ^{④-②-③} HW4L-A1F20Q ^{④-②-③}
	Transformer	120V AC 120V AC 240V AC 240V AC	1NO-1NC 2NO 1NO-1NC 2NO	HW1L-M1F11H2 ^{④-②} HW1L-M1F20H2 ^{④-②} HW1L-M1F11M4 ^{④-②} HW1L-M1F20M4 ^{④-②}	HW1L-A1F11H2 ^{④-②} HW1L-A1F20H2 ^{④-②} HW1L-A1F11M4 ^{④-②} HW1L-A1F20M4 ^{④-②}	HW4L-M1F11H2 ^{④-②} HW4L-M1F20H2 ^{④-②} HW4L-M1F11M4 ^{④-②} HW4L-M1F20M4 ^{④-②}
Extended 	Full Voltage	1NO 1NC 1NO-1NC 2NO	HW1L-M2F10Q ^{④-②-③} HW1L-M2F01Q ^{④-②-③} HW1L-M2F11Q ^{④-②-③} HW1L-M2F20Q ^{④-②-③}	HW1L-A2F10Q ^{④-②-③} HW1L-A2F01Q ^{④-②-③} HW1L-A2F11Q ^{④-②-③} HW1L-A2F20Q ^{④-②-③}	HW4L-M2F10Q ^{④-②-③} HW4L-M2F01Q ^{④-②-③} HW4L-M2F11Q ^{④-②-③} HW4L-M2F20Q ^{④-②-③}	HW4L-A2F10Q ^{④-②-③} HW4L-A2F01Q ^{④-②-③} HW4L-A2F11Q ^{④-②-③} HW4L-A2F20Q ^{④-②-③}
	Transformer	120V AC 120V AC 240V AC 240V AC	1NO-1NC 2NO 1NO-1NC 2NO	HW1L-M2F11H2 ^{④-②} HW1L-M2F20H2 ^{④-②} HW1L-M2F11M4 ^{④-②} HW1L-M2F20M4 ^{④-②}	HW1L-A2F11H2 ^{④-②} HW1L-A2F20H2 ^{④-②} HW1L-A2F11M4 ^{④-②} HW1L-A2F20M4 ^{④-②}	HW4L-M2F11H2 ^{④-②} HW4L-M2F20H2 ^{④-②} HW4L-M2F11M4 ^{④-②} HW4L-M2F20M4 ^{④-②}
Extended with Full Shroud 	Full Voltage	1NO 1NC 1NO-1NC 2NO	HW1L-MF2F10Q ^{④-②-③} HW1L-MF2F01Q ^{④-②-③} HW1L-MF2F11Q ^{④-②-③} HW1L-MF2F20Q ^{④-②-③}	HW1L-AF2F10Q ^{④-①-③} HW1L-AF2F01Q ^{④-①-③} HW1L-AF2F11Q ^{④-①-③} HW1L-AF2F20Q ^{④-①-③}	HW4L-MF2F10Q ^{④-②-③} HW4L-MF2F01Q ^{④-②-③} HW4L-MF2F11Q ^{④-②-③} HW4L-MF2F20Q ^{④-②-③}	HW4L-AF2F10Q ^{④-①-③} HW4L-AF2F01Q ^{④-①-③} HW4L-AF2F11Q ^{④-①-③} HW4L-AF2F20Q ^{④-①-③}
	Transformer	120V AC 120V AC 240V AC 240V AC	1NO-1NC 2NO 1NO-1NC 2NO	HW1L-MF2F11H2 ^{④-②} HW1L-MF2F20H2 ^{④-②} HW1L-MF2F11M4 ^{④-②} HW1L-MF2F20M4 ^{④-②}	HW1L-AF2F11H2 ^{④-②} HW1L-AF2F20H2 ^{④-②} HW1L-AF2F11M4 ^{④-②} HW1L-AF2F20M4 ^{④-②}	HW4L-MF2F11H2 ^{④-②} HW4L-MF2F20H2 ^{④-②} HW4L-MF2F11M4 ^{④-②} HW4L-MF2F20M4 ^{④-②}
40mm Mushroom Head 	Full Voltage	1NO 1NC 1NO-1NC 2NO	HW1L-M4F10Q ^{④-②-③} HW1L-M4F01Q ^{④-②-③} HW1L-M4F11Q ^{④-②-③} HW1L-M4F20Q ^{④-②-③}	HW1L-A4F10Q ^{④-②-③} HW1L-A4F01Q ^{④-②-③} HW1L-A4F11Q ^{④-②-③} HW1L-A4F20Q ^{④-②-③}	HW4L-M4F10Q ^{④-②-③} HW4L-M4F01Q ^{④-②-③} HW4L-M4F11Q ^{④-②-③} HW4L-M4F20Q ^{④-②-③}	HW4L-A4F10Q ^{④-②-③} HW4L-A4F01Q ^{④-②-③} HW4L-A4F11Q ^{④-②-③} HW4L-A4F20Q ^{④-②-③}
	Transformer	120V AC 120V AC 240V AC 240V AC	1NO-1NC 2NO 1NO-1NC 2NO	HW1L-M4F11H2 ^{④-②} HW1L-M4F20H2 ^{④-②} HW1L-M4F11M4 ^{④-②} HW1L-M4F20M4 ^{④-②}	HW1L-A4F11H2 ^{④-②} HW1L-A4F20H2 ^{④-②} HW1L-A4F11M4 ^{④-②} HW1L-A4F20M4 ^{④-②}	HW4L-M4F11H2 ^{④-②} HW4L-M4F20H2 ^{④-②} HW4L-M4F11M4 ^{④-②} HW4L-M4F20M4 ^{④-②}
Square Flush 	Full Voltage	1NO 1NC 1NO-1NC 2NO	HW2L-M1F10Q ^{④-②-③} HW2L-M1F01Q ^{④-②-③} HW2L-M1F11Q ^{④-②-③} HW2L-M1F20Q ^{④-②-③}	HW2L-A1F10Q ^{④-②-③} HW2L-A1F01Q ^{④-②-③} HW2L-A1F11Q ^{④-②-③} HW2L-A1F20Q ^{④-②-③}	-	-
	Transformer	120V AC 120V AC 240V AC 240V AC	1NO-1NC 2NO 1NO-1NC 2NO	HW2L-M1F11H2 ^{④-②} HW2L-M1F20H2 ^{④-②} HW2L-M1F11M4 ^{④-②} HW2L-M1F20M4 ^{④-②}	HW2L-A1F11H2 ^{④-②} HW2L-A1F20H2 ^{④-②} HW2L-A1F11M4 ^{④-②} HW2L-A1F20M4 ^{④-②}	-

Switches & Pilot Devices



- In place of ② specify the Lens Color Code, in place of ③ specify the Full Voltage Code and in place of ④ specify Lamp Type Code.
- For partial and sub-assembly part numbers, see pages A-88 and A-89.
- For nameplates and accessories, see page A-113.
- For dimensions, see page A-116.

④ Lamp Type Code

Lamp	Code
Incandescent	Blank
LED	D

② Lens Color Code

Color	Code
Amber	A
Green	G
Red	R
Blue	S
White	W
Yellow	Y*



*40mm mushroom lenses not available in yellow

③ Full Voltage Codes

Voltage	Code
6V AC/DC	6V
12V AC/DC	12V
24V AC/DC	24V
120V AC (LED only)	120V
240VAC (LED only)	240V

Illuminated Pushbuttons (Partial-Assemblies)

Contact Assembly + Lamp* + Operator/Lens = Complete Switch



*Lamp is included in contact assembly for transformer models only.

Part Numbers: Operators/Lens

Type		Plastic Bezel	Metal Bezel
Flush		Momentary HW1L-M1-②	HW4L-M1-②
		Maintained HW1L-A1-②	HW4L-A1-②
Extended		Momentary HW1L-M2-②	HW4L-M2-②
		Maintained HW1L-A2-②	HW4L-A2-②
Extended/Full shroud		Momentary HW1L-MF2-②	HW4L-MF2-②
		Maintained HW1L-AF2-②	HW4L-AF2-②
Mushroom		Momentary HW1L-M4-②	HW4L-M4-②
		Maintained HW1L-A4-②	HW4L-A4-②
Square		Momentary HW2L-M1-②	-
		Maintained HW2L-A1-②	



In place of ②, specify the Lens Color Code.

Part Numbers: Full Voltage Contact Assemblies

(order lamp separately)

Style	Contacts	Part Number
	1NO	HW-FL10Q0
	2NO	HW-FL20Q0
	1NO/1NC	HW-FL11Q0
	1NC	HW-FL01Q0
	2NC	HW-FL02Q0



Order lamp separately.

Part Numbers: Transformer Contact Assemblies

(lamp included)

Style	Contacts	Part Number	
	120V AC with LED	1NO 2NO 1NC 1NO/1NC	HW-FL10H2-② HW-FL20H2-② HW-FL01H2-② HW-FL11H2-②
	240V AC with LED	1NO 2NO 1NC 1NO/1NC	HW-FL10M4-② HW-FL20M4-② HW-FL01M4-② HW-FL11M4-②
	480V AC with LED	1NO 2NO 1NC 1NO/1NC	HW-FL10T8-② HW-FL20T8-② HW-FL01T8-② HW-FL11T8-②
	120V AC with Incandescent	1NO 2NO 1NC 1NO/1NC	HW-FL10H2 HW-FL20H2 HW-FL01H2 HW-FL11H2
240V AC with Incandescent	1NO 2NO 1NC 1NO/1NC	HW-FL10M4 HW-FL20M4 HW-FL01M4 HW-FL11M4	

Part Numbers: Lamps

Type	Voltage	Part Number
LED	6V AC/DC	LSTD-6②
	12V AC/DC	LSTD-1②
	24V AC/DC	LSTD-2②
	120V AC	LSTD-H2②
	240V AC	LSTD-M4②
Incandescent	6.3V AC/DC	IS-6
	12V AC/DC	IS-12
	24V AC/DC	IS-24
	30V AC/DC	IS-30



- In place of ②, specify the LED Color Code from table below.
- The LED contains a current-limiting resistor and reverse polarity protection diodes.

② Lens/LED Color Code

Color	Code
Amber	A
Green	G
Red	R
Blue	S
White	W
Yellow	Y

Illuminated Pushbuttons (Sub-Assembled)

Part Numbers: LED and Incandescent Illuminated Pushbuttons

Transformer * + Contact Blocks + Lead Holder + Adaptor † + Lamp + Anti-Rotation Ring + Operator + Lens = Complete Part



1. * Transformer not needed with full voltage types.
2. † Adaptor includes safety lever lock.

Part Numbers: Lenses

Style	Part Number
Round Flush 	HW1A-L1-②
Round Extended 	HW1A-L2-②
Ø 40mm Mushroom Cap 	ALW4BLU-②*
Square Flush 	HW2A-L1-②



1. n place of ②, specify the Lens Color Code.
2. *not available in yellow.

Part Numbers: Operators

Style		Part Number	
		Plastic Bezel	Metal Bezel
Round Flush/Extended 	Momentary	HW1L-M0	HW4L-M0
	Maintained	HW1L-A0	HW4L-A0
Extended with Full Shroud 	Momentary	HW1L-MF0	HW4L-MF0
	Maintained	HW1L-AF0	HW4L-AF0
Ø 40mm Mushroom Head 	Momentary	HW1L-M0L	HW4L-M0L
	Maintained	HW1L-A0L	HW4L-A0L
Square Flush 	Momentary	HW2L-M0	-
	Maintained	HW2L-A0	

② Lens/LED Color Code

Color	Code
Amber	A
Green	G
Red	R
Blue	S
White	W
Yellow	Y*



*ALW4BLU not available in yellow.

Illuminated Pushbuttons (Sub-Assembled) con't



Part Numbers: Anti-Rotation Ring

Appearance	Part Number
	HW9Z-RL



Use with notched panel cutout to prevent unit rotation





Part Numbers: Lamps

Type	Voltage	Part Number
LED 	6V AC/DC	LSTD-6②
	12V AC/DC	LSTD-1②
	24V AC/DC	LSTD-2②
	120V AC	LSTD-H2②
	240V AC	LSTD-M4②
Incandescent 	6.3V AC/DC	IS-6
	12V AC/DC	IS-12
	24V AC/DC	IS-24
	30V AC/DC	IS-30



- In place of ②, specify the LED Color Code from table on previous page.
- The LED contains a current-limiting resistor and reverse polarity protection diodes.





Part Numbers: Lamp Circuit Components

Style	Description	Terminals	Part Number
	For use with HW-CBL on all illuminated pushbutton units. One required for each deck (pair) of contacts.		HW-LH3
	For use with odd number of contacts.	Fingersafe	HW-DA1FB
		Exposed	HW-DA1B
		Spring Up	HW-GA1
	For use with even number of contacts.	Fingersafe	TW-DA1FB
		Exposed	TW-DA1B
	120VAC 240VAC 480VAC	Fingersafe	TW-F126B TW-F246B TW-F486B
	120V 240V 480V	Spring Up	HW-T126 HW-T246B HW-L486
	(6V secondary voltage)	Exposed	TW-T126B TW-T246B TW-T486B
DC-DC Converter	110VDC		HW-L16D



HW-GA1 "Dummy Block with full voltage adaptor" does not require the use of HW-LH3.

Part Numbers: Contact Blocks

Description	Part Number	
	1NO	1NC
Standard Fingersafe (IP20) 	HW-F10 HW-F10R (early make)	HW-F01 HW-F01R (late break)
Spring-Up Terminal Contacts 	HW-G10 HW-G10R (early make)	HW-G01 HW-G01R (late break)
Exposed Screw Terminal Contacts 	HW-C10 HW-C10R (early make)	HW-C01 HW-C01R (late break)
Dummy Block 	TW-DB	



- All assembled part numbers in catalog include standard (HW-F...) contacts.
- Assembled units with spring-up terminals (HW-G...) can be ordered by removing an "F" from the part number (Ex. HW1B-M1F11-R becomes HW1B-M111-R).
- Units with exposed screw terminals (HW-C...) must be ordered as sub-components.

Part Numbers: Contact Block Mounting Adaptor (safety lever lock included)

Style	Part Number
	HW-CBL



- Used to mount contact blocks to operator (first pair only). Lamp holder is built-in.
- IDEC strongly recommends using the safety lever lock (included) to prevent heavy vibration or maintenance personnel from unlocking contacts.

Selector Switches (Assembled)

Part Numbers: 2-Position Selector Switches

Contact	Mounting	Operator Position		Maintained	Spring Return from Right
		L	R		
				Part Number	Part Number
1NO	1	0	X	HW [Ⓢ] S-2TF10	HW [Ⓢ] S-21TF10
1NO-1NC	1	0	X	HW [Ⓢ] S-2TF11	HW [Ⓢ] S-21TF11
	2	X	0		
2NO	1	0	X	HW [Ⓢ] S-2TF20	HW [Ⓢ] S-21TF20
	2	0	X		

A

Switches & Pilot Devices

Part Numbers: 3-Position Selector Switches

Contact	Mounting	Operator Position			Maintained	Spring Return from Right	Spring Return from Left	Spring Return Two-Way
		L	C	R				
					Part Number	Part Number	Part Number	Part Number
2NO	1	X	0	0	HW [Ⓢ] S-3TF20	HW [Ⓢ] S-31TF20	HW [Ⓢ] S-32TF20	HW [Ⓢ] S-33TF20
	2	0	0	X				
2NO-1NC	1	X	0	0	HW [Ⓢ] S-3JTF21N1	—	—	—
	2	0	0	X				
	3	0	X	0				
2NO-2NC	1	X	0	0	HW [Ⓢ] S-3TF22	HW [Ⓢ] S-31TF22	HW [Ⓢ] S-32TF22	HW [Ⓢ] S-33TF22
	2	0	0	X				
	3	0	X	X				
	4	X	X	0				

Part Numbers: 4-Position Selector Switch

Contact	Mounting	Operator Position				Maintained Part Number
		1	2	3	4	
						Part Number
2NO-2NC	1	X	0	0	0	HW [Ⓢ] S-4TF22N3
	2	0	X	0	0	
	3	0	0	X	0	
	4	0	0	0	X	

Part Numbers: 5-Position Selector Switch

Contact	Mounting	Operator Position					Maintained Part Number
		1	2	3	4	5	
							Part Number
2NO-2NC	1	X	0	0	0	0	HW [Ⓢ] S-5TF22N3
	2	0	X	0	0	0	
	3	0	0	0	X	0	
	4	0	0	0	0	X	



1. In place of [Ⓢ] enter 1 for plastic bezel or 4 for metal bezel.
2. Mounting refers to contact location on operator. See page A-105.
3. For nameplates, see page A-113.
4. Custom contact arrangements available. Contact IDEC for details.
5. Five position circuit cannot be made to make five independent contact closures.

Selector Switches (Partial-Assemblies)

Contact Assembly + Operator = Complete Part



A

Switches & Pilot Devices

Part Numbers: Operators

	No. of Positions	Description		Plastic Bezel	Metal Bezel
	2	Maintained	Standard Knob	HW1S-2T	HW4S-2T
			Lever Handle	HW1S-2L	HW4S-2L
		Spring Return from Right	Standard Knob	HW1S-21T	HW4S-21T
			Lever Handle	HW1S-21L	HW4S-21L
	3	Maintained (standard cam)	Standard Knob	HW1S-3T*	HW4S-3T*
			Lever Handle	HW1S-3L	HW4S-3L
		Maintained (S cam)	Standard Knob	HW1S-3ST*	HW4S-3ST*
		Maintained (J cam)	Standard Knob	HW1S-3JT*	HW4S-3JT*
		Spring Return from Right	Standard Knob	HW1S-31T	HW4S-31T
			Lever Handle	HW1S-31L	HW4S-31L
		Spring Return from Left	Standard Knob	HW1S-32T	HW4S-32T
			Lever Handle	HW1S-32L	HW4S-32L
	2-Way Spring Return	Standard Knob	HW1S-33T	HW4S-33T	
		Lever Handle	HW1S-33L	HW4S-33L	
4	Maintained	Standard Knob	HW1S-4T	HW4S-4T	
		Lever Handle	HW1S-4L	HW4S-4L	
5	Maintained	Standard Knob	HW1S-5T	HW4S-5T	
		Lever Handle	HW1S-5L	HW4S-5L	



1. Knob operator includes knob.
2. * Three position operator is available with three different cams.
3. Operator cams are color coded (white=standard cam, red=S cam, black =J cam).
4. For details of determining which cam to use, see page A-102.

Part Numbers: Contact Assemblies

Style	Contacts	Part Number
Standard Fingersafe Contacts 	1NO 1NC 1NO/1NC 2NO 2NC 2NO/2NC	HW-CBF10 HW-CBF01 HW-CBF11 HW-CBF20 HW-CBF02 HW-CBF22
Spring Up Terminal Contacts 	1NO 1NC 1NO/1NC 2NO 2NC 2NO/2NC	HW-CB10 HW-CB01 HW-CB11 HW-CB20 HW-CB02 HW-CB22

Selector Switches (Sub-Assembled)

Contact Blocks + Adaptor and Safety Lever Lock + Anti-Rotation Ring + Operator = Complete Part



Part Numbers: Operators

No. of Positions	Description		Plastic Bezel	Metal Bezel
2	Maintained	Standard Knob	HW1S-2T	HW4S-2T
		Lever Handle	HW1S-2	HW4S-2
	Spring Return from Right	Standard Knob	HW1S-21T	HW4S-21T
		Lever Handle	HW1S-21	HW4S-21
3	Maintained (standard cam)	Standard Knob	HW1S-3T*	HW4S-3T*
		Lever Handle	HW1S-3*	HW4S-3*
	Maintained (S cam)	Standard Knob	HW1S-3ST*	HW4S-3ST*
	Maintained (J cam)	Standard Knob	HW1S-3JT*	HW4S-3JT*
	Spring Return from Right	Standard Knob	HW1S-31T	HW4S-31T
		Lever Handle	HW1S-31	HW4S-31
	Spring Return from Left	Standard Knob	HW1S-32T	HW4S-32T
		Lever Handle	HW1S-32	HW4S-32
	2-Way Spring Return	Standard Knob	HW1S-33T	HW4S-33T
		Lever Handle	HW1S-33	HW4S-33
4	Maintained	Standard Knob	HW1S-4T	HW4S-4T
		Lever Handle	HW1S-4	HW4S-4
5	Maintained	Standard Knob	HW1S-5T	HW4S-5T
		Lever Handle	HW1S-5	HW4S-5

- Knob operator includes knob.
- Lever operators require lever and insert to be ordered separately.
- * Three position operator is available with three different cams.
- Operator cams are color coded (white=standard cam, red=S cam, black =J cam).
- For details of determining which cam to use, see page A-102.

Part Numbers: Levers and Inserts

Style	Part Number
Lever	ASWHHL-①
Lever Color Insert	TW-HC1-①

① Handle/Insert Color Code

Color	Code
Black*	B
Blue	S
Green	G
Red	R
Yellow	Y
White†	W

* Lever color inserts not available in black.
 † Knob and lever not available in white.

Part Numbers: Anti-Rotation Ring

Appearance	Part Number
	HW9Z-RL

- Use with notched panel cutout to prevent unit rotation.
- Not required when using HW series nameplates See page A-113.

Part Numbers: Contact Block Mounting Adaptor (safety lever lock included)

Appearance	Part Number
	HW-CB2C

- Used to mount contact blocks to operator (first pair only).
- IDEC strongly recommends using the safety lever lock (included) to prevent heavy vibration or maintenance personnel from unlocking contacts.

Part Numbers: Contact Blocks

Description	Part Number	
	1NO	1NC
Standard Fingersafe (IP20)	HW-F10 HW-F10R (early make)	HW-F01 HW-F01R (late break)
Spring-Up Terminal Contacts	HW-G10 HW-G10R (early make)	HW-G01 HW-G01R (late break)
Exposed Screw Terminal Contacts	HW-C10 HW-C10R (early make)	HW-C01 HW-C01R (late break)
Dummy Block	TW-DB	

- All assembled part numbers in catalog include standard (HW-F...) contacts.
- Assembled units with spring-up terminals (HW-G...) can be ordered by removing an "F" from the part number (Ex. HW1B-M1F11-R becomes HW1B-M111-R).
- Units with exposed screw terminals (HW-C...) must be ordered as sub-components.

Key Switches (Assembled)

A

Switches & Pilot Devices



Part Numbers: 2-Position Key Switches

		Operator Position		Part Number	
				Maintained	Spring Return from Right
Contact	Mounting	L	R		
1NO	1	0	X	HW [Ⓢ] K-2AF10	HW [Ⓢ] K-21BF10
1NO-1NC	1	0	X	HW [Ⓢ] K-2AF11	HW [Ⓢ] K-21BF11
	2	X	0		
2NO	1	0	X	HW [Ⓢ] K-2AF20	HW [Ⓢ] K-21BF20
	2	0	X		

Key Removable Option Codes

Code	Description
A	Key retained in NO position (removable in all positions)
B	Key retained in right position only
C	Key retained in left position only
D	Key retained in left and right (3 position only)
E	Key retained in center only (3 position only)
G	Key retained right and center (3 position only)
H	Key retained left and center (3 position only)



For more information on these options, contact your IDEC representative.

Part Numbers: 3-Position Key Switches

		Operator Position			Part Number			
					Maintained	Spring Return from Right	Spring Return from Left	Spring Return from Left & Right
Contact	Mounting	L	C	R				
2NO	1	X	0	0	HW [Ⓢ] K-3AF20	HW [Ⓢ] K-31BF20	HW [Ⓢ] K-32CF20	HW [Ⓢ] K-33DF20
	2	0	0	X				
2NO-2NC	1	X	0	0	HW [Ⓢ] K-3AF22	HW [Ⓢ] K-31BF22	HW [Ⓢ] K-32CF22	HW [Ⓢ] K-33DF22
	2	0	0	X				
	3	0	X	X				
	4	X	X	0				



- In place of [Ⓢ] enter 1 for plastic bezel or 4 for metal bezel.
- Key is removable in all maintained positions. Other key removable options available.
- Two keys are supplied with all switches.
- All standard operators are keyed alike (contact IDEC for special keys).
- For nameplates, see page A-113.
- Custom contact arrangements available, contact IDEC for details.
- Mounting refers to contact location on operator. For more information, see page A-118.

Key Switches (Partial-Assemblies)

Contact Assembly + Operator = Complete Part



Part Numbers: Operators

	# of Positions	Description	Plastic Bezel	Metal Bezel
	2	Maintained	HW1K-2A	HW4K-2A
		Maintained, key remove left only	HW1K-2B	HW4K-2B
		Spring from Right	HW1K-21B	HW4K-21B
	3	Maintained, Standard Cam	HW1K-3A	HW4K-3A
		Maintained, Cam A	HW1K-3SA	HW4K-3SA
		Maintained, Cam S	HW1K-3JA	HW4K-3JA
		Spring Return from Right	HW1K-31B	HW4K-31B
		Spring Return from Left	HW1K-32C	HW4K-32C
		Two-Way Spring Return	HW1K-33D	HW4K-33D



- Operator includes two keys.
- All standard operators are keyed alike (contact IDEC for special keys).
- Other key removable options available. See "Other Key Removable Option Codes" on next page.

Part Numbers: Contact Assemblies

Style	Contacts	Part Number
Standard Fingersafe Contacts 	1NO 1NC 1NO/1NC 2NO 2NC 2NO/2NC	HW-CBF10 HW-CBF01 HW-CBF11 HW-CBF20 HW-CBF02 HW-CBF22
Spring Up Terminal Contacts 	1NO 1NC 1NO/1NC 2NO 2NC 2NO/2NC	HW-CB10 HW-CB01 HW-CB11 HW-CB20 HW-CB02 HW-CB22

Key Removable Option Codes

Code	Description
A	Key retained in NO position (removable in all positions)
B	Key retained in right position only
C	Key retained in left position only
D	Key retained in left and right (3 position only)
E	Key retained in center only (3 position only)
G	Key retained right and center (3 position only)
H	Key retained left and center (3 position only)



For more information on these options, contact your IDEC representative.

Key Switches (Sub-Assembled)

Contact Blocks + Adaptor & Safety Lever Lock + Anti-Rotation Ring + Operator = Complete Part



Switches & Pilot Devices

Part Numbers: Operators

# of Positions	Description	Plastic Bezel	Metal Bezel
2	Maintained	HW1K-2A	HW4K-2A
	Maintained, key remove left only	HW1K-2B	HW4K-2B
	Spring from Right	HW1K-21B	HW4K-21B
3	Maintained, Standard Cam	HW1K-3A	HW4K-3A
	Maintained, Cam S	HW1K-3SA	HW4K-3SA
	Maintained, Cam J	HW1K-3JA	HW4K-3JA
	Spring Return from Right	HW1K-31B	HW4K-31B
	Spring Return from Left	HW1K-32C	HW4K-32C
	Two-Way Spring Return	HW1K-33D	HW4K-33D

- 1. Operator includes two keys.
- 2. All standard operators are keyed alike (contact IDEC for special keys).
- 3. Other key removable options available. See table below.

Part Numbers: Contact Block Mounting Adaptor (safety lever lock included)

Style	Part Number
	HW-CB2C





- 1. Used to mount contact blocks to operator (first pair only).
- 2. IDEC strongly recommends using the safety lever lock (included) to prevent heavy vibration or maintenance personnel from unlocking contacts.

Key Removable Option Codes

Code	Description
A	Key retained in NO position (removable in all positions)
B	Key retained in right position only
C	Key retained in left position only
D	Key retained in left and right (3 position only)
E	Key retained in center only (3 position only)
G	Key retained right and center (3 position only)
H	Key retained left and center (3 position only)

For more information on these options, contact your IDEC representative.

Part Numbers: Contact Blocks

Description	Part Number	
	1NO	1NC
Standard Fingersafe (IP20)		
	HW-F10 HW-F10R (early make)	HW-F01 HW-F01R (late break)
Spring-Up Terminal Contacts		
	HW-G10 HW-G10R (early make)	HW-G01 HW-G01R (late break)
Exposed Screw Terminal Contacts		
	HW-C10 HW-C10R (early make)	HW-C01 HW-C01R (late break)
Dummy Block		
	TW-DB	

- 1. All assembled part numbers in catalog include standard (HW-F...) contacts.
- 2. Assembled units with spring-up terminals (HW-G...) can be ordered by removing an "F" from the part number (Ex. HW1B-M1F11-R becomes HW1B-M111-R).
- 3. Units with exposed screw terminals (HW-C...) must be ordered as sub-components.

Part Numbers: Anti-Rotation Ring

Appearance	Part Number
	HW9Z-RL

- 1. Use with notched panel cutout to prevent unit rotation (not included with assembled units).
- 2. Not required when using HW series nameplates See page A-113.

Illuminated Selector Switches (Assembled)



Part Numbers: 2-Position LED/Incandescent Selector Switches with Plastic Bezel

Plastic Bezel	Operator Position				Type	Part Number		
	Contact	Mounting	L	R		Maintained	Spring Return From Right	
	1NO-1NC	1 2	0	X	Full Voltage	HW1F-2F11Q ^{④-②-③}		
			X	0		Transformer	120V 240V 480V	HW1F-2F11H2 ^{④-②} HW1F-2F11M4 ^{④-②} HW1F-2F11T8 ^{④-②}
		2NO	1 2	0	X	Full Voltage	HW1F-2F20Q ^{④-②-③}	
				0	X		Transformer	120V 240V 480V
		2NO-2NC	1 2 3 4	0	X	Full Voltage	HW1F-2F22Q ^{④-②-③}	
				X	0		Transformer	120V 240V 480V

② Lens/LED Color Code

Color	Code
Amber	A
Green	G
Red	R
Blue	S
White	W
Yellow	Y

③ Full Voltage Code

Voltage	Code
6V AC/DC	6V
12V AC/DC	12V
24V AC/DC	24V
120V AC (LED only)	120 V
240V AC (LED only)	240 V

④ Lamp Type Code

Lamp	Code
Incandescent	Blank
LED	D



- In place of ② specify the Lens/LED color code.
- In place of ③ specify the Full Voltage code.
- In place of ④ specify Lamp Type code.
- For nameplates, see page A-113.
- For partial and sub-assembly part numbers, see pages A-99 and A-100.
- Mounting refers to contact location on operator. See page A-105.

Part Numbers: 2-Position LED/Incandescent Selector Switches with Metal Bezel

Metal Bezel	Operator Position				Type	Part Number		
	Contact	Mounting	L	R		Maintained	Spring Return From Right	
	1NO-1NC	1 2	0	X	Full Voltage	HW4F-2F11Q ^{④-②-③}		
			X	0		Transformer	120V 240V 480V	HW4F-2F11H2 ^{④-②} HW4F-2F11M4 ^{④-②} HW4F-2F11T8 ^{④-②}
		2NO	1 2	0	X	Full Voltage	HW4F-2F20Q ^{④-②-③}	
				0	X		Transformer	120V 240V 480V
		2NO-2NC	1 2 3 4	0	X	Full Voltage	HW4F-2F22Q ^{④-②-③}	
				X	0		Transformer	120V 240V 480V



- In place of ② specify the Lens/LED color code.
- In place of ③ specify the Full Voltage code.
- In place of ④ specify Lamp Type code.
- For nameplates, see page A-113.
- For partial and sub-assembly part numbers, see pages A-99 and A-100.
- Mounting refers to contact location on operator. See page A-105.

Illuminated Selector Switches (Assembled) con't

Part Numbers: 3-Position LED/Incandescent Selector Switches with Plastic Bezel

Contact	Mounting	Operator Position			Type	Part Number	Part Number	Part Number	Part Number
		L	C	R					
2NO	1 2	X	0	0	Full Voltage	HW1F-3F20Q ^{④-②-③}	HW1F-31F20Q ^{④-②-③}	HW1F-32F20Q ^{④-②-③}	HW1F-33F20Q ^{④-②-③}
		0	0	X					
					240V HW1F-3F20M4 ^{④-②}	240V HW1F-31F20M4 ^{④-②}	240V HW1F-32F20M4 ^{④-②}	240V HW1F-33F20M4 ^{④-②}	
					480V HW1F-3F20T8 ^{④-②}	480V HW1F-31F20T8 ^{④-②}	480V HW1F-32F20T8 ^{④-②}	480V HW1F-33F20T8 ^{④-②}	
2NC	1 2	0	X	X	Full Voltage	HW1F-3F02Q ^{④-②-③}	HW1F-31F02Q ^{④-②-③}	HW1F-32F02Q ^{④-②-③}	HW1F-33F02Q ^{④-②-③}
		X	X	0					
					240V HW1F-3F02M4 ^{④-②}	240V HW1F-31F02M4 ^{④-②}	240V HW1F-32F02M4 ^{④-②}	240V HW1F-33F02M4 ^{④-②}	
					480V HW1F-3F02T8 ^{④-②}	480V HW1F-31F02T8 ^{④-②}	480V HW1F-32F02T8 ^{④-②}	480V HW1F-33F02T8 ^{④-②}	
2NO-2NC	1 2 3 4	X	0	0	Full Voltage	HW1F-3F22Q ^{④-②-③}	HW1F-31F22Q ^{④-②-③}	HW1F-32F22Q ^{④-②-③}	HW1F-33F22Q ^{④-②-③}
		0	0	X					
					240V HW1F-3F22M4 ^{④-②}	240V HW1F-31F22M4 ^{④-②}	240V HW1F-32F22M4 ^{④-②}	240V HW1F-33F22M4 ^{④-②}	
					480V HW1F-3F22T8 ^{④-②}	480V HW1F-31F22T8 ^{④-②}	480V HW1F-32F22T8 ^{④-②}	480V HW1F-33F22T8 ^{④-②}	
4NO	1 2 3 4	X	0	0	Full Voltage	HW1F-3F40Q ^{④-②-③}	HW1F-31F40Q ^{④-②-③}	HW1F-32F40Q ^{④-②-③}	HW1F-33F40Q ^{④-②-③}
		0	0	X					
					240V HW1F-3F40M4 ^{④-②}	240V HW1F-31F40M4 ^{④-②}	240V HW1F-32F40M4 ^{④-②}	240V HW1F-33F40M4 ^{④-②}	
					480V HW1F-3F40T8 ^{④-②}	480V HW1F-31F40T8 ^{④-②}	480V HW1F-32F40T8 ^{④-②}	480V HW1F-33F40T8 ^{④-②}	
4NC	1 2 3 4	0	X	X	Full Voltage	HW1F-3F04Q ^{④-②-③}	HW1F-31F04Q ^{④-②-③}	HW1F-32F04Q ^{④-②-③}	HW1F-33F04Q ^{④-②-③}
		X	X	0					
					240V HW1F-3F04M4 ^{④-②}	240V HW1F-31F04M4 ^{④-②}	240V HW1F-32F04M4 ^{④-②}	240V HW1F-33F04M4 ^{④-②}	
					480V HW1F-3F04T8 ^{④-②}	480V HW1F-31F04T8 ^{④-②}	480V HW1F-32F04T8 ^{④-②}	480V HW1F-33F04T8 ^{④-②}	



- In place of ② specify the Lens/LED color code.
- In place of ③ specify the Full Voltage code.
- In place of ④- specify Lamp Type code.
- For nameplates, see page A-113.
- For partial and sub-assembly part numbers, see pages A-99 and A-100.
- Mounting refers to contact location on operator. See page A-105.

Part Numbers: 3-Position LED/Incandescent Selector Switches with Metal Bezel

Metal Bezel	Contact	Mounting	Operator Position			Type	Part Number	Part Number	Part Number	Part Number
			L	C	R					
2NO	1 2	X	0	0	Full Voltage	HW1F-3F20Q ^{④-②-③}	HW1F-31F20Q ^{④-②-③}	HW1F-32F20Q ^{④-②-③}	HW1F-33F20Q ^{④-②-③}	
		0	0	X						Transformer
					240V HW1F-3F20M4 ^{④-②}	240V HW1F-31F20M4 ^{④-②}	240V HW1F-32F20M4 ^{④-②}	240V HW1F-33F20M4 ^{④-②}		
					480V HW1F-3F20T8 ^{④-②}	480V HW1F-31F20T8 ^{④-②}	480V HW1F-32F20T8 ^{④-②}	480V HW1F-33F20T8 ^{④-②}		
2NC	1 2	0	X	X	Full Voltage	HW1F-3F02Q ^{④-②-③}	HW1F-31F02Q ^{④-②-③}	HW1F-32F02Q ^{④-②-③}	HW1F-33F02Q ^{④-②-③}	
		X	X	0						Transformer
					240V HW1F-3F02M4 ^{④-②}	240V HW1F-31F02M4 ^{④-②}	240V HW1F-32F02M4 ^{④-②}	240V HW1F-33F02M4 ^{④-②}		
					480V HW1F-3F02T8 ^{④-②}	480V HW1F-31F02T8 ^{④-②}	480V HW1F-32F02T8 ^{④-②}	480V HW1F-33F02T8 ^{④-②}		
2NO-2NC	1 2 3 4	X	0	0	Full Voltage	HW1F-3F22Q ^{④-②-③}	HW1F-31F22Q ^{④-②-③}	HW1F-32F22Q ^{④-②-③}	HW1F-33F22Q ^{④-②-③}	
		0	0	X						Transformer
					240V HW1F-3F22M4 ^{④-②}	240V HW1F-31F22M4 ^{④-②}	240V HW1F-32F22M4 ^{④-②}	240V HW1F-33F22M4 ^{④-②}		
					480V HW1F-3F22T8 ^{④-②}	480V HW1F-31F22T8 ^{④-②}	480V HW1F-32F22T8 ^{④-②}	480V HW1F-33F22T8 ^{④-②}		
4NO	1 2 3 4	X	0	0	Full Voltage	HW1F-3F40Q ^{④-②-③}	HW1F-31F40Q ^{④-②-③}	HW1F-32F40Q ^{④-②-③}	HW1F-33F40Q ^{④-②-③}	
		0	0	X						Transformer
					240V HW1F-3F40M4 ^{④-②}	240V HW1F-31F40M4 ^{④-②}	240V HW1F-32F40M4 ^{④-②}	240V HW1F-33F40M4 ^{④-②}		
					480V HW1F-3F40T8 ^{④-②}	480V HW1F-31F40T8 ^{④-②}	480V HW1F-32F40T8 ^{④-②}	480V HW1F-33F40T8 ^{④-②}		
4NC	1 2 3 4	0	X	X	Full Voltage	HW1F-3F04Q ^{④-②-③}	HW1F-31F04Q ^{④-②-③}	HW1F-32F04Q ^{④-②-③}	HW1F-33F04Q ^{④-②-③}	
		X	X	0						Transformer
					240V HW1F-3F04M4 ^{④-②}	240V HW1F-31F04M4 ^{④-②}	240V HW1F-32F04M4 ^{④-②}	240V HW1F-33F04M4 ^{④-②}		
					480V HW1F-3F04T8 ^{④-②}	480V HW1F-31F04T8 ^{④-②}	480V HW1F-32F04T8 ^{④-②}	480V HW1F-33F04T8 ^{④-②}		



- In place of ② specify the Lens/LED color code.
- In place of ③ specify the Full Voltage code.
- In place of ④- specify Lamp Type code.
- For nameplates, see page A-113.
- For partial and sub-assembly part numbers, see pages A-99 and A-100.
- Mounting refers to contact location on operator. See page A-105.



Illuminated Selector Switches (Partial-Assemblies)

Contact Assembly + Lamp + Operator/Lens = Complete Part



Full Voltage Models

Part Numbers: Operators/Lens

	Type	Plastic	Metal
	Maintained	HW1F-2②	HW4F-2②
	Spring from Right	HW1F-21②	HW4F-21②
	Spring from Left	HW1F-22②	HW4F-22②
	Maintained	HW1F-3②	HW4F-3②
	Spring from Right	HW1F-31②	HW4F-31②
	Spring from Left	HW1F-32②	HW4F-32②
	Spring from Both	HW1F-33②	HW4F-33②



In place of ②, specify the Lens Color Code from table below.

Part Numbers: Contact Assemblies (order lamp separately)

Style	Contacts	Part Number
	1NO	HW-FL10Q0
	2NO	HW-FL20Q0
	1NO/1NC	HW-FL11Q0
	1NC	HW-FL01Q0
	2NC	HW-FL02Q0



Order lamp separately from table on right.

Part Numbers: Lamps

Type	Voltage	Part Number
	6V AC/DC	LSTD-6②
	12V AC/DC	LSTD-1②
	24V AC/DC	LSTD-2②
	120V AC	LSTD-H2②
	240V AC	LSTD-M4②
	6.3V AC/DC	IS-6
	12V AC/DC	IS-12
	24V AC/DC	IS-24



- In place of ②, specify the LED Color Code from table below.
- The LED contains a current-limiting resistor and reverse polarity protection diodes.

Transformer Models

Part Numbers: Contact Assemblies (lamp included)

Style	Contacts	Part Number
	1NO	HW-FL10H2-②
	2NO	HW-FL20H2-②
	1NC	HW-FL01H2-②
	1NO/1NC	HW-FL11H2-②
	1NO	HW-FL10M4-②
	2NO	HW-FL20M4-②
	1NC	HW-FL01M4-②
	1NO/1NC	HW-FL11M4-②
	1NO	HW-FL10T8-②
	2NO	HW-FL20T8-②
	1NC	HW-FL01T8-②
	1NO/1NC	HW-FL11T8-②
	1NO	HW-FL10H2
	2NO	HW-FL20H2
	1NC	HW-FL01H2
	1NO/1NC	HW-FL11H2
	1NO	HW-FL10M4
	2NO	HW-FL20M4
	1NC	HW-FL01M4
	1NO/1NC	HW-FL11M4



6V LED/Lamp included with transformer sub-assembly.

Part Numbers: Operators/Lens

	Type	Plastic	Metal
	Maintained	HW1F-2②	HW4F-2②
	Spring from Right	HW1F-21②	HW4F-21②
	Spring from Left	HW1F-22②	HW4F-22②
	Maintained	HW1F-3②	HW4F-3②
	Spring from Right	HW1F-31②	HW4F-31②
	Spring from Left	HW1F-32②	HW4F-32②
	Spring from Both	HW1F-33②	HW4F-33②



In place of ②, specify the Lens Color Code from table below.

② Lens/LED Color Code

Color	Code
Amber	A
Green	G
Red	R
Blue	S
White	W
Yellow	Y

Illuminated Selector Switches (Sub-Assembled)

Transformer * + Contact Blocks + Lead Holder + Adaptor + Lamp + Anti-Rotation + Operator + Illuminated Knob = Complete Part

Switches & Pilot Devices



* not applicable for full voltage units

Part Numbers: Operators

Appearance	# of Positions	Description	Plastic Bezel	Metal Bezel
	2	Maintained	HW1F-2	HW4F-2
		Spring return from right	HW1F-21	HW4F-21
	3	Maintained	HW1F-3	HW4F-3
		Spring return from right	HW1F-31	HW4F-31
		Spring return from left	HW1F-32	HW4F-32
		Two-way spring return	HW1F-33	HW4F-33



Illuminated knobs must be ordered separately.

Part Numbers: Illuminated Knob

Appearance	Description	Part Number
	Amber	HW9Z-FDY-A
	Green	HW9Z-FDY-G
	Red	HW9Z-FDY-R
	Blue	HW9Z-FDY-S
	White	HW9Z-FDY-W
	Yellow	HW9Z-FDY-Y

Part Numbers: Contact Block Mounting Adaptor (safety lever lock included)

Style	Part Number
	HW-CBL



- Used to mount contact blocks to operator (first pair only). Lamp holder is built-in.
- IDEC strongly recommends using the safety lever lock (included) to prevent heavy vibration or maintenance personnel from unlocking contacts.

Part Numbers: Contact Blocks



Description	Part Number	
	1NO	1NC
Standard Fingersafe (IP20) 	HW-F10 HW-F10R (early make)	HW-F01 HW-F01R (late break)
Spring-Up Terminal Contacts 	HW-G10 HW-G10R (early make)	HW-G01 HW-G01R (late break)
Exposed Screw Terminal Contacts 	HW-C10 HW-C10R (early make)	HW-C01 HW-C01R (late break)
Dummy Block 	TW-DB	



- All assembled part numbers in catalog include standard (HW-F...) contacts.
- Assembled units with spring-up terminals (HW-G...) can be ordered by removing an "F" from the part number (Ex. HW1B-M1F11-R becomes HW1B-M111-R).
- Units with exposed screw terminals (HW-C...) must be ordered as sub-components.

Illuminated Selector Switches (Sub- Assembled) con't



Part Numbers: Lamps

Type	Voltage	Part Number
LED 	6V AC/DC	LSTD-6 ^②
	12V AC/DC	LSTD-1 ^②
	24V AC/DC	LSTD-2 ^②
	120V AC	LSTD-H2 ^②
	240V AC	LSTD-M4 ^②
Incandescent 	6.3V AC/DC	IS-6
	12V AC/DC	IS-12
	24V AC/DC	IS-24



1. In place of ^②, specify the LED Color Code from table at right.
2. The LED contains a current-limiting resistor and reverse polarity protection diodes.

Part Numbers: Lamp Circuit Components

Style	Description	Terminals	Part Number
Lead Holder 	For use with HW-CBL on all illuminated pushbutton units. One required for each deck (pair) of contacts.		HW-LH3
Dummy Block with Full Voltage Adaptor 	For use with odd number of contacts.	Fingersafe	HW-DA1FB
		Exposed	HW-DA1B
		Spring Up	HW-GA1
Full Voltage Adaptor 	For use with even number of contacts.	Fingersafe	TW-DA1FB
		Exposed	TW-DA1B



- HW-GA1 "Dummy Block with full voltage adaptor" does not require the use of HW-LH3.

Part Numbers: Transformer Unit

Style	Voltage	Part Number
Fingersafe	120V AC 240V AC 480V AC	TW-F126B TW-F246B TW-F486B
Spring Up	 120V AC 240V AC 480V AC	HW-T126 HW-T246 HW-L486
(6V secondary voltage)		
DC-DC Converter	110VDC	HW-L16D

② LED Color Code

Color	Code
Amber	A
Green	G
Red	R
Blue	S
White	W
Yellow	Y

Part Numbers: Anti-Rotation Ring

Appearance	Part Number
	HW9Z-RL



1. Use with notched panel cutout to prevent unit rotation.
2. Not required when using HW series nameplates See page A-113.

Custom Selector Switch Building Guide

To build a custom selector switch, follow these steps.

Step 1: How many positions of the switch are needed?

A

of positions
(2, 3, 4, 5)

Step 2: How many contacts should there be?

of isolated contacts
(maximum 6)

Step 3: Fill in the Truth Table

(X = closed, 0 = open)

		Knob Position				
		1	2	3	4	5
C o n t a c t s	1					
	2					
	3					
	4					
	5					
	6					

Step 4: If building a 2, 4, or 5 position selector, skip this step. (2, 4, 5 position selectors have only one cam)

If building a 3 position selector, determine appropriate cam as follows:

Look at Row 1 from above table and locate an identical row in the operator truth tables (See next page).

Repeat for all rows. Find one operator that contains all rows from above table.

Record the operator cam version.

Operator CAM Version
(blank, S, J for 3 position)

Step 5: Build by placing appropriate contact in appropriate mounting position for each desired row on operator cam truth table. "L" and "R" refer to mounting on left or right side of operator as viewed from the front of the panel.

Caution: Before putting any custom selector switch into use, it should be tested using an ohmmeter.



For Operator Truth Tables, see next page.

Operator Truth Tables

Use the following tables to build custom selector switches.

2 Position Selector Switches

HW1S-2T
HW1K-2*
HW1F-2

Contact	Mounting Position	Operator Position	
		Left	Right
HW-F10 (NO)	L	0	X
	R	0	X
HW-F01 (NC)	L	X	0
	R	X	0
HW-F10R NO-(EM)	L	0	X
	R	0	X
HW-F01R NC-(LB)	L	X	0
	R	X	0



1. Mounting position indicates which side of operator each contact should be mounted (as viewed from the front of the panel).
2. * for key removable code (see page A-96).

3 Position Selector Switches

HW1S-3T
HW1K-3*
HW1F-3

Contact	Mounting Position	Operator Position		
		Left	Center	Right
HW-F10 (NO)	L	X	0	0
	R	0	0	X
HW-F01 (NC)	L	0	X	X
	R	X	X	0
HW-F10R NO-(EM)	L	X	0	0
	R	0	0	X
HW-F01R NC-(LB)	L	0	X	X
	R	X	X	0



1. HW1S-3T is identified by white plungers on the operator.
2. Mounting position indicates which side of operator each contact should be mounted (as viewed from the front of the panel).
3. * for key removable code (see page A-96).

HW1S-3ST
HW1K-3S*

Contact	Mounting Position	Operator Position		
		Left	Center	Right
HW-F10 (NO)	L	X	0	0
	R	0	0	X
HW-F01 (NC)	L	0	0	X
	R	X	0	0
HW-F10R NO-(EM)	L	X	X	0
	R	0	X	X
HW-F01R NC-(LB)	L	0	X	X
	R	X	X	0



1. HW1S-3ST is identified by red plungers on the operator.
2. Mounting position indicates which side of operator each contact should be mounted (as viewed from the front of the panel).
3. * for key removable code (see page A-96).

HW1S-3JT
HW1K-3J*

Contact	Mounting Position	Operator Position		
		Left	Center	Right
HW-F10 (NO)	L	X	0	0
	R	0	0	X
HW-F01 (NC)	L	0	X	0
	R	0	X	0
HW-F10R NO-(EM)	L	X	0	X
	R	X	0	X
HW-F01R NC-(LB)	L	0	X	X
	R	X	X	0



1. HW1S-3JT is identified by black plungers on the operator.
2. Mounting position indicates which side of operator each contact should be mounted (as viewed from the front of the panel).
3. * for key removable code (see page A-96).

Operator Truth Tables con't

4 Position Selector Switches

Contact	Mounting Position	Operator Position			
		1	2	3	4
HW-F10 (NO)	L	X	0	0	0
	R	0	0	0	X
HW-F01 (NC)	L	0	0	X	0
	R	0	X	0	0
HW-F10R NO-(EM)	L	X	X	0	X
	R	X	0	X	X
HW-F01R NC-(LB)	L	0	X	X	X
	R	X	X	X	0

HW1S-4T

5 Position Selector Switches

Contact	Mounting Position	Operator Position				
		1	2	3	4	5
HW-F10 (NO)	L	X	0	0	0	0
	R	0	0	0	0	X
HW-F01 (NC)	L	0	0	0	X	0
	R	0	X	0	0	0
HW-F10R NO-(EM)	L	X	X	X	0	X
	R	X	0	X	X	X
HW-F01R NC-(LB)	L	0	X	X	X	X
	R	X	X	X	X	0

HW1S-5T



Mounting position indicates which side of operator each contact should be mounted (as viewed from the front of the panel).



Switches & Pilot Devices

Custom Selector Switch Building Examples

Example 1: 3 Position, Maintained Selector Switch with 3 Contacts

Determine which operator is capable of producing all the desired contact actions.

	Knob Position			Operator		
	Left	Center	Right	HW1S-3T	HW1S-3ST	HW1S-3JT
Contact 1	0	0	X	Possible with HW-F10 mounted on right	Possible with HW-F10 mounted on right	Possible with HW-F10 mounted on right
Contact 2	0	X	0	Not possible	Not possible	Possible with HW-F01 mounted on left or right
Contact 3	X	0	0	Possible with HW-F10 mounted on left	Possible with HW-F10 mounted on left	Possible with HW-F10 mounted on left

The only operator in this example that will produce all the desired contact actions is HW1S-3JT. Assemble as follows:

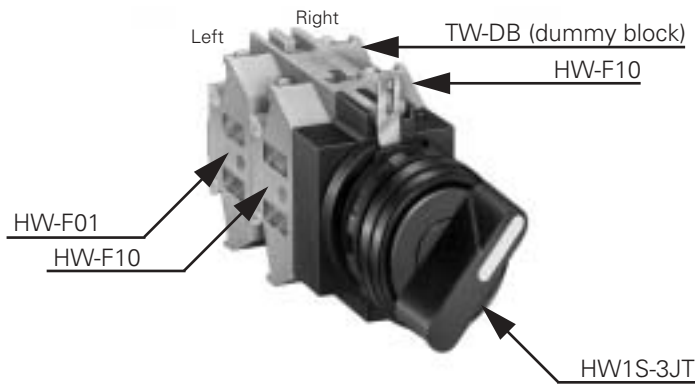

Example 2: 3 Position, Maintained Selector Switch with 2 Contacts

Determine which operator is capable of producing all the desired contact actions.

	Knob Position			Operator		
	Left	Center	Right	HW1S-3T	HW1S-3ST	HW1S-3JT
Contact 1	0	0	X	Possible with HW-F10 mounted on right	Possible with HW-F10 mounted on right	Possible with HW-F10 mounted on right
Contact 2	0	X	X	Possible with HW-F01 mounted on left	Possible with HW-F10R mounted on right or HW-F01R mounted on left	Not possible

This arrangement is possible with either the HW1S-3T or HW1S-3ST operator. It is preferred to use the HW1S-3T as this requires only the standard contacts (HW-F10 and HW-F01 and not the early make (HW-F10R) or late break (HW-F01R) contacts. Assemble as follows:

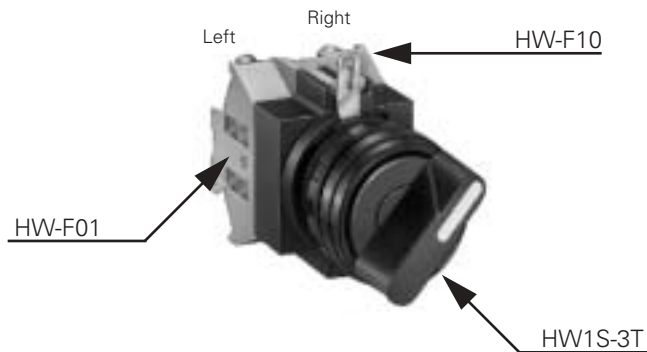

Custom Selector Switch Building Examples con't

Example 3: 4 Position Selector Switch with 4 Contacts

Determine where the contact will be mounted.

	Knob Position				Operator
	1	2	3	4	HW1S-4T
Contact 1	0	X	0	0	HW-F01 mounted on right
Contact 2	0	0	X	0	HW-F01 mounted on left
Contact 3	0	0	0	X	HW-F10 mounted on right
Contact 4	0	X	X	X	HW-F01R mounted on left

Assemble as follows:

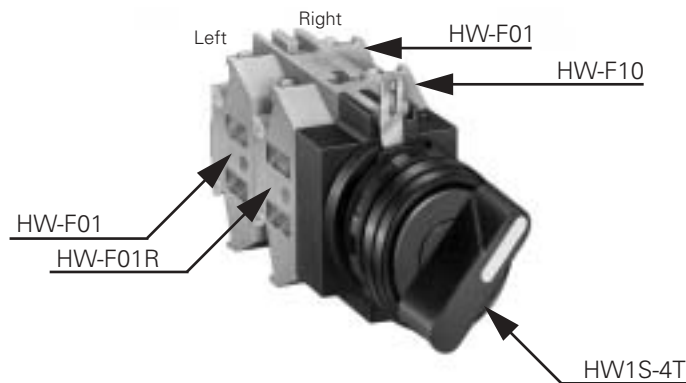

Example 4: 5 Position Selector Switch with 4 Contacts

Determine where the contact will be mounted.

	Knob Position					Operator
	1	2	3	4	5	HW1S-5T
Contact 1	0	X	0	0	0	HW-F01 mounted on right
Contact 2	0	0	0	X	0	HW-F01 mounted on left
Contact 3	0	0	0	0	X	HW-F10 mounted on right
Contact 4	X	0	X	X	X	HW-F10R mounted on right

Assembled as follows:

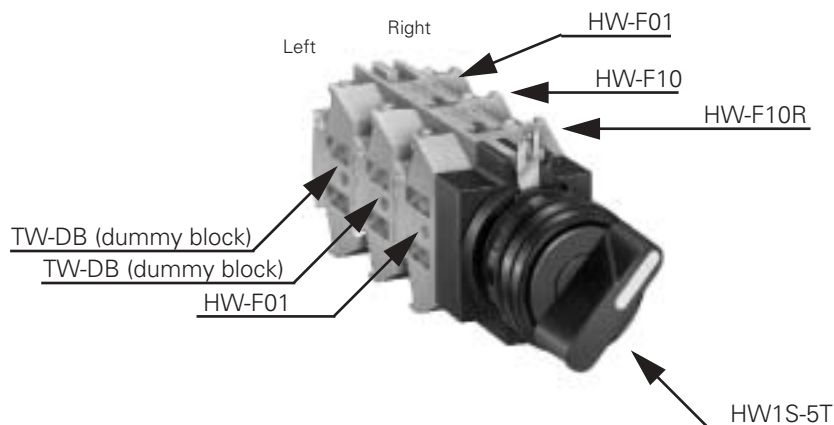

Mono Lever Switches (Assembled)



Part Number Guide

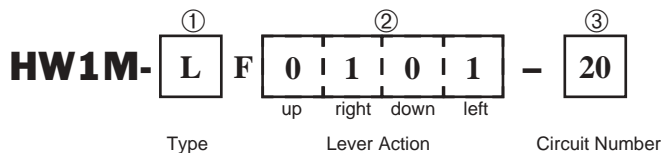

Description	Code	Remarks
① Type	Standard	(blank)
	Interlocking	L
② Lever Action	Maintained	1
	Spring	2
	Blocked	0
③ Circuit Number	20	See Circuit Diagrams below
	40	
	22N9	

Part Numbers: Mono Lever Switches

Description	No. of Positions	Part Number
HW1M Standard Lever	2	HW1M-F1010-20
		HW1M-F2020-20
		HW1M-F0101-20
		HW1M-F0202-20
		HW1M-F0101-40
		HW1M-F0202-40
	4	HW1M-F1111-22N9
		HW1M-F2222-22N9
HW1M-L Interlocking Lever	2	HW1M-LF1010-20
		HW1M-LF2020-20
		HW1M-LF0101-20
		HW1M-LF0202-20
	4	HW1M-LF0101-40
		HW1M-LF0202-40
		HW1M-LF1111-22N9
		HW1M-LF2222-22N9



Switches & Pilot Devices

Circuit Diagrams

2 Position Left/Right

Circuit Number	Contact Mounting		Position		
	No.		Left	Center	Right
20	1	HW-F10	X	0	0
	2	HW-F10	0	0	X
40	1	HW-F10	X	0	0
	2	HW-F10	0	0	X
	3	HW-F10	X	0	0
	4	HW-F10	0	0	X

2 Position Up/Down

Circuit Number	Contact Mounting		Position		
	No.		Down	Center	Up
20	1	HW-F10	X	0	0
	2	HW-F10	0	0	X
40	1	HW-F10	X	0	0
	2	HW-F10	0	0	X
	3	HW-F10	X	0	0
	4	HW-F10	0	0	X

4 Position

Circuit Number	Contact Mounting		Position				
	No.		Down	Left	Center	Up	Right
22N9	1	HW-F01	0	0	0	0	X
	2	HW-F01	X	0	0	0	0
	3	HW-F10	0	X	0	0	0
	4	HW-F10	0	0	0	X	0





Other circuit arrangements available, contact IDEC for details.

Mono Lever Switches (Sub-Assembled)

Contact Blocks + Mounting Adaptor + Anti-Rotation Ring + Operator = Complete Part



Part Numbers: Operators

Appearance	# of Positions	Description	Part Number
	2	Maintained Up/Down	HW1M-1010
		Spring return Up/Down	HW1M-2020
		Maintained Left/Right	HW1M-0101
		Spring return Left/Right	HW1M-0202
	4	Maintained, 4 position	HW1M-1111
		Spring return, 4 position	HW1M-2222
	2	Maintained Up/Down	HW1M-L1010
		Spring return Up/Down	HW1M-L2020
		Maintained Left/Right	HW1M-L0101
		Spring return Left/Right	HW1M-L0202
	4	Maintained, 4 position	HW1M-L1111
		Spring return, 4 position	HW1M-L2222

Part Numbers: Contact Block Mounting Adaptor (safety lever lock included)

Appearance	Part Number
	HW-CB2C



-  1. Used to mount contact blocks to operator (first pair only).
- 2. IDEC strongly recommends using the safety lever lock (included) to prevent heavy vibration or maintenance personnel from unlocking contacts.

Part Numbers: Anti-Rotation Ring





Appearance	Part Number
	HW9Z-RL

-  1. Use with notched panel cutout to prevent unit rotation.
- 2. Not required when using HW series nameplates See page A-113.

Part Numbers: Replacement Parts

Item	Part Number
Black Cap 	HW9Z-CPM
Boot 	HW9Z-BLM (fits standard type operator only)

Part Numbers: Contact Blocks

Description	Part Number	
	1NO	1NC
Standard Fingersafe (IP20) 	HW-F10 HW-F10R (early make)	HW-F01 HW-F01R (late break)
Spring-Up Terminal Contacts 	HW-G10 HW-G10R (early make)	HW-G01 HW-G01R (late break)
Exposed Screw Terminal Contacts 	HW-C10 HW-C10R (early make)	HW-C01 HW-C01R (late break)
Dummy Block 	TW-DB	

-  1. All assembled part numbers in catalog include standard (HW-F...) contacts.
- 2. Assembled units with spring-up terminals (HW-G...) can be ordered by removing an "F" from the part number (Ex. HW1B-M1F11-R becomes HW1B-M111-R).
- 3. Units with exposed screw terminals (HW-C...) must be ordered as sub-components.

Pushbutton Selectors (Assembled)

Part Numbers: 2-Position Pushbutton Selectors

Contacts	Mounting		Operator Position				Part Number
			Left		Right		
			Normal	Depressed	Normal	Depressed	
2NO	1	HW-F10	0	X	0	0	HW1R-2DF20-①
	2	HW-F10	0	0	0	X	
2NO-2NC	1	HW-F10	0	X	0	0	HW1R-2DF22N1-①
	2	HW-F10	0	0	0	X	
	3	HW-F01	X	0	X	X	
	4	HW-F01	X	X	X	0	
2NO-2NC	1	HW-F10	0	X	0	0	HW1R-2EF22N1-①
	2	HW-F10	0	0	0	X	
	3	HW-F01	0	0	X	X	
	4	HW-F01	X	X	0	0	
2NO-2NC	1	HW-F10	0	0	0	X	HW1R-2FF22N1-①
	2	HW-F10	0	X	0	0	
	3	HW-F01	0	0	X	0	
	4	HW-F01	X	0	0	0	



1. Available only with momentary pushbutton and maintained selector.
2. In place of ①, specify the button color code from table below
3. Other contact arrangements available. Contact IDEC for details.
4. All assembled parts use flush buttons.
5. **Normal** position refers to the button flush with the selector ring.
6. **Depressed** position refers to the button being pushed in.

① Button Color Code

Color	Code
Black	B
Green	G
Red	R
Blue	S
White	W
Yellow	Y
Grey	N

Pushbutton Selectors (Partial-Assemblies)

Contact Assembly + Operator/Button = Complete Part



Switches & Pilot Devices

Part Numbers: Operators

Appearance	Description	Part Number
	Cam D	HW1R-2D-①
	Cam E	HW1R-2E-①
	Cam F	HW1R-2F-①



In place of ① specify Button Color Code.

Part Numbers: Contact Assemblies

Style	Contacts	Part Number
Standard Fingersafe Contacts 	1NO 1NC 1NO/1NC 2NO 2NC 2NO/2NC	HW-CBF10 HW-CBF01 HW-CBF11 HW-CBF20 HW-CBF02 HW-CBF22
Spring Up Terminal Contacts 	1NO 1NC 1NO/1NC 2NO 2NC 2NO/2NC	HW-CB10 HW-CB01 HW-CB11 HW-CB20 HW-CB02 HW-CB22

① Button Color Code

Color	Code
Black	B
Green	G
Red	R
Blue	S
White	W
Yellow	Y
Grey	N

Pushbutton Selectors (Sub-Assembled)

A

Switches & Pilot Devices

Contact Blocks + Contact Mounting Adaptor + Anti-Rotation Ring + Operator + Button = Complete Part



Part Numbers: Operators

Appearance	Description	Part Number
	Cam D	HW1R-2D
	Cam E	HW1R-2E
	Cam F	HW1R-2F

Part Numbers: Buttons

Description	Part Number
Round Flush 	HW1A-B1-①



In place of ① specify Button Color Code.

Part Numbers: Anti-Rotation Ring

Appearance	Part Number
	HW9Z-RL



1. Use with notched panel cutout to prevent unit rotation.
2. Not required when using HW series name-plates See page A-113.

Part Numbers: Contact Block Mounting Adaptor (safety lever lock included)

Appearance	Part Number
	HW-CB2C



1. Used to mount contact blocks to operator (first pair only).
2. IDEC strongly recommends using the safety lever lock (included) to prevent heavy vibration or maintenance personnel from unlocking contacts.

Part Numbers: Contact Blocks

Description	Part Number	
	1NO	1NC
Standard Fingersafe (IP20) 	HW-F10 HW-F10R (early make)	HW-F01 HW-F01R (late break)
Spring-Up Terminal Contacts 	HW-G10 HW-G10R (early make)	HW-G01 HW-G01R (late break)
Exposed Screw Terminal Contacts 	HW-C10 HW-C10R (early make)	HW-C01 HW-C01R (late break)
Dummy Block 	TW-DB	





1. All assembled part numbers in catalog include standard (HW-F...) contacts.
2. Assembled units with spring-up terminals (HW-G...) can be ordered by removing an "F" from the part number (Ex. HW1B-M1F11-R becomes HW1B-M111-R).
3. Units with exposed screw terminals (HW-C...) must be ordered as sub-components.

① Button Color Code

Color	Code
Black	B
Green	G
Red	R
Blue	S
White	W
Yellow	Y
Grey	N

Contactor Reset Button

Part Numbers: Reset Buttons (Assembled)

Appearance	Plastic Bezel	Metal Bezel
 (Blank)	HW1B-M1RS-①T	HW4B-M1RS-①T
 Engraved "R"	HW1B-M1RS-①T-ENG-R	HW4B-M1RS-①T-ENG-R

① Button Color Code

Color	Code
Black	B
Green	G
Grey	N
Red	R
Blue	S
White	W
Yellow	Y

-  1. In place of ① specify Button Color Code.
 2. 5.1" (130mm) overall length.
 3. 16mm flat base for easy alignment

Sub-Assemblies

Rod + Operator + Button = Complete Part



Part Numbers: Button

Appearance	Part Number
	HW1A-B1-①

 In place of ① specify Button Color Code from table.

Part Numbers: Rod

Appearance	Part Number
	HW9Z-RS-TK2141

Part Numbers: Operator

Appearance	Plastic	Metal
 	HW1B-M0	HW4B-M0

① Button Color Code

Color	Code
Black	B
Green	G
Grey	N
Red	R
Blue	S
White	W
Yellow	Y

Nameplates — HW Series

Part Numbers: Nameplates

	HWAM—Black Plastic	HWAQ—Black Plastic	HWAS—Black Plastic	HWAV—Yellow Plastic
	Part Number	Part Number	Part Number	Part Number
Nameplate (blank engraving plate included)	HWAM-0B	HWAQ-0B	HWAS-0B	HWAV-0Y
Nameplate (engraved)	HWAM-①	HWAQ-①	HWAS-①	HWAV-27* HWAV-527†
Additional Insert (blank)	HWNP-0	HWNP-0	HWNP Dimensions	
Additional Insert (engraved)	HWNP-①	HWNP-①		



1. In place of ①, insert either the standard legend code from table below or custom engraving delimited by “ ”.
2. Standard engravings are available at no charge.
3. * HWAV-27 comes engraved “Emergency Stop” as shown in drawing.
4. † HWAV-527 for 80mm diameter jumbo mushroom comes engraved “Emergency Stop” as shown in drawing.

Standard Legend Codes

Pushbuttons				Pushbuttons/Selector Switches				Selector Switches	
Legend	Code	Legend	Code	Legend	Code	Legend	Code	Legend	Code
AUTO	101	OPEN	116	AUTO-MAN	201			AUTO-MAN-OFF	301
CLOSE	102	OUT	117	CLOSE-OPEN	202			AUTO-OFF-MAN	302
DOWN	103	RAISE	118	DOWN-UP	203			CLOSE-OFF-OPEN	303
EMERG.STOP	104	RESET	119	FAST-SLOW	204	REV-FOR	216	DOWN-OFF-SLOW	304
FAST	105	REVERSE	120	FOR-REV	205	RUN-JOG	217	FAST-OFF-SLOW	305
FORWARD	106	RUN	121	HAND-AUTO	206	RUN-SAFE	218	FOR-OFF-REV	306
HAND	107	SLOW	122	HIGH-LOW	207	SAFE-RUN	219	LEFT-OFF-RIGHT	307
HIGH	108	START	123	JOG-RUN	208	SLOW-FAST	220	LOWER-OFF-RAISE	308
IN	109	STOP	125	LEFT-RIGHT	209	START-STOP	221	OFF-MAN-AUTO	309
INCH	110	TEST	126	LOWER-RAISE	210	STOP-START	222	OFF-SLOW-FAST	310
JOG	111	UP	127	MAN-AUTO	211	UP-DOWN	223	OFF-1-2	311
LOW	112	O (Int'l On)	150	OFF-ON	212	O1 (Int'l OFF ON)	250	OPEN-OFF-CLOSE	312
LOWER	113	O (Int'l Off)	151	ON-OFF	213			SLOW-OFF-FAST	313
OFF	114	EMO	152	OPEN-CLOSE	214			SUMMER-OFF-WINTER	314
ON	115			RAISE-LOWER	215			UP-OFF-DOWN	315
								1-OFF-2	316
								HAND-OFF-AUTO	317



1. To order engraved nameplates, add legend code to nameplate part number.
2. Character height based on the number of characters and size of nameplate. Standard character size is 3/16".
3. Nameplates with standard legends are the same list price as blank nameplates.
4. Nameplates have built-in anti-rotation feature for use with notched panel cut-outs. Additional anti-rotation ring (HW9Z-RL) is not necessary.

Nameplates Order Form — HW Series

Copy this order form and use it to specify Letter Height, Custom Engravings, Location of Engraving on Nameplate, and Quantity Desired. To insure engraving accuracy, fax it to your IDEC representative or Distributor.

Your Company: _____
 Name: _____
 Telephone: _____
 Fax & Email: _____

IDEC Rep/Distributor Contact: _____
 PO number (if known): _____
 IDEC Rep/Distributor Phone: _____
 IDEC Rep/Distributor Fax & Email: _____

Switches & Pilot Devices

HWAM Nameplate

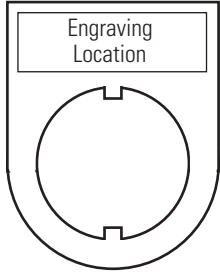

Step 1. Choose Letter Size - 7/64" or 1/8".
 Check the box for the letter size you want. Then write your lettering in box below checkboxes. Note: 1/8" size letters cannot exceed 9 characters.

7/64" Letter Size 11 characters max (for 7/64" size letters)

1/8" Letter Size 9 characters max (for 1/8" size letters)

Step 2. Specify Quantity.
 Enter the number of nameplates desired in the box on the right.

Qty

1	2	3	4	5	6	7	8	9	10	11
---	---	---	---	---	---	---	---	---	----	----

Sample Letter Sizes
 7/64" Letters: A B C D
 1/8" Letters: A B C D

HWAQ Nameplate

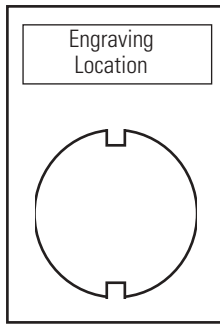

Step 1. Choose Letter Size - 7/64" or 1/8".
 Check the box for the letter size you want. Then write your lettering in box below checkboxes. Note: 1/8" size letters cannot exceed 9 characters.

7/64" Letter Size 11 characters max (for 7/64" size letters)

1/8" Letter Size 9 characters max (for 1/8" size letters)

Step 2. Specify Quantity.
 Enter the number of nameplates desired in the box on the right.

Qty

1	2	3	4	5	6	7	8	9	10	11
---	---	---	---	---	---	---	---	---	----	----

Sample Letter Sizes
 7/64" Letters: A B C D
 1/8" Letters: A B C D

HWAS Nameplate

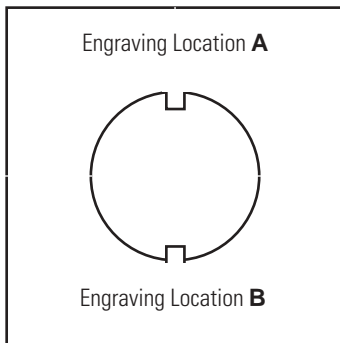

Step 1. Choose Letter Size - 1/8" or 3/32".
 Check the box for the letter size you want. Then write your lettering in box below checkboxes. Note: 1/8" size letters cannot exceed 14 characters.

3/32" Letter Size 20 characters maximum (for 3/32" size letters)

1/8" Letter Size 14 characters maximum (for 1/8" size letters)

Step 2. Specify Quantity.
 Enter the number of nameplates desired in box on the right.

Qty

















Step 3. Specify Location.
 Enter the location of engraving (A or B), in box on the right.

Location

Sample Letter Sizes
 3/32" Letters: A B C D
 1/8" Letters: A B C D

1	2	3	4	5	6	7	8	9	10	11	12	13	14	15	16	17	18	19	20
---	---	---	---	---	---	---	---	---	----	----	----	----	----	----	----	----	----	----	----

Accessories — HW Series

	Appearance	Description/Usage	Part Number	
Locking Ring Wrench		Metallic tool used to tighten the plastic locking ring when installing the HW series unit in a panel	MW9Z-T1	
Lamp/LED Removal Tool		Rubber tool makes lamp/LED removal easier.	OR-55	
Anti-Rotation Ring		Prevents rotation of switches in panel. (included with all assembled switches)	for notched panel cut-out (standard)	HW9Z-RL
			for round panel cutout	LW9Z-LN10
Rubber Mounting Hole Plug		Black rubber plug fills unused mounting holes in panel.	OB-31	
Metallic Mounting Hole Plug		For plugging unused mounting holes in the panel. Tighten the attached locking ring to a torque of 12 kfg-cm maximum Degree of protection: IP66	LW9Z-BM	
Barrier		To prevent contact between adjacent lead wires when control units are tightly mounted	HW-VL1	
Pushbutton Clear Boot		Used to cover and protect pushbuttons Operating temperature: -50 to +60°C	Flush Pushbuttons	OC-31
			Extended Pushbuttons	OC-32
Padlock Cover		Plastic hinged cover to protect pushbuttons or selector switches. (Not intended for mushroom buttons or E-Stops) Degree of protection: IP65	HW9Z-KL1	
Tab Terminal Adapter		Tab #250 (6.35 x 0.8mm): Single tab	TW-FA1	
Adaptor (22mm to 30mm)		Used to mount round HW series control unit (except Jumbo Mushroom, unibody, and square units) into a 30mm panel cut-out. (includes both pieces)	HW9Z-A30	
Replacement Safety Lever Lock		Used to prevent contact mounting lever from moving due to heavy vibration or panel maintenance. (included with all Contact Block Mounting Adaptors)	HWLS-TK1971	
Reset Rod for Contactors Overload		10" rod used with HW1B-M0. See Contactors Section D for more information.	HW9Z-RS-TK2141	
Replacement Locking Ring		Plastic locking nut comes with all HW operators & assemblies.	Standard (plastic)	HW9Z-LN
			Optional (metal)	HW9Z-LNM
Switch Cover (Square)		Used only with round or square flush pushbuttons.	HW9Z-K1 (spring return) HW9Z-K11 (maintained cover)	
Replacement Keys		Pair of Keys (#231)	HW9Z-SK-231PN02	
Replacement Lens		HW Illuminated Unibody Replacement Lens	HWLV-LENSR	

Dimensions — HW Series

Non-Illuminated Pushbuttons

A

Switches & Pilot Devices

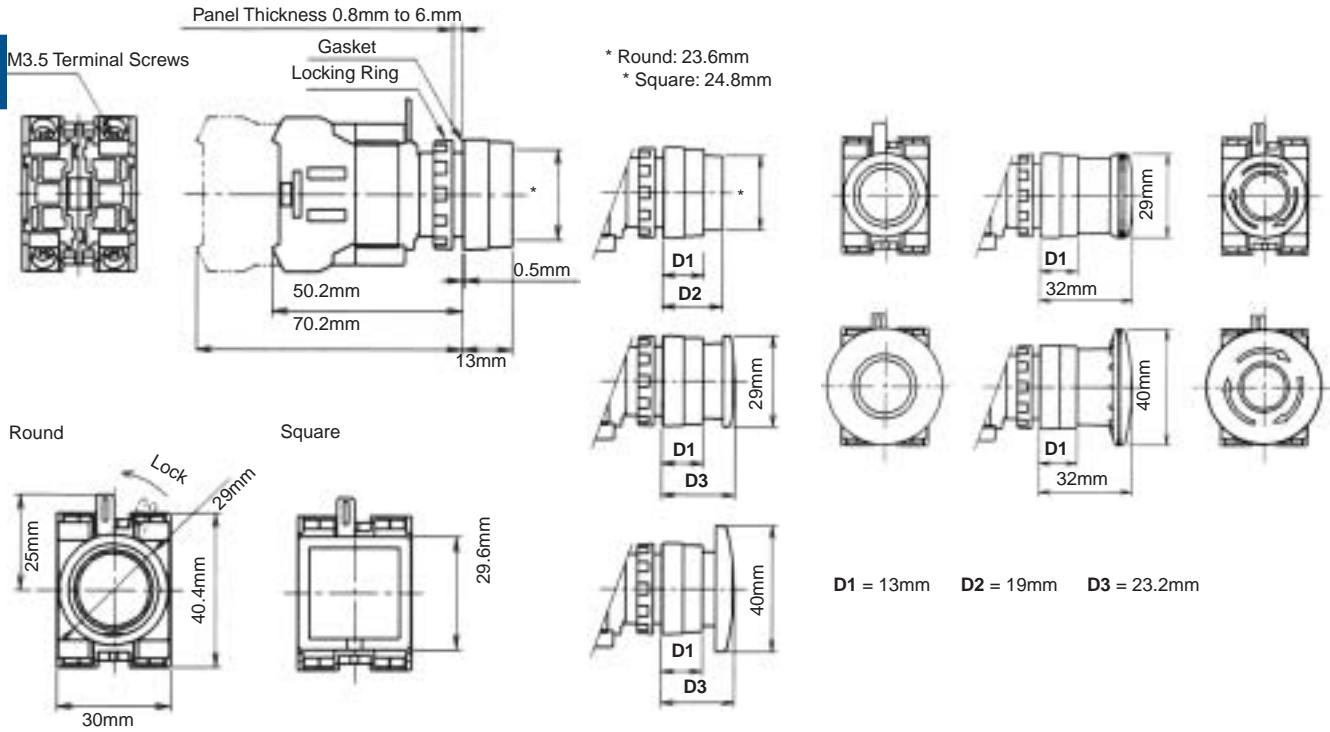

Monolever

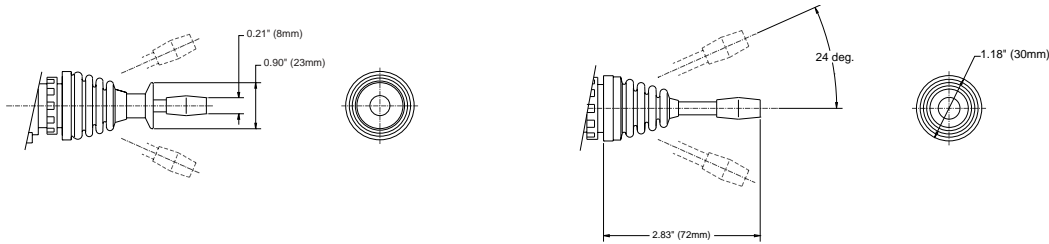

Pilot Lights

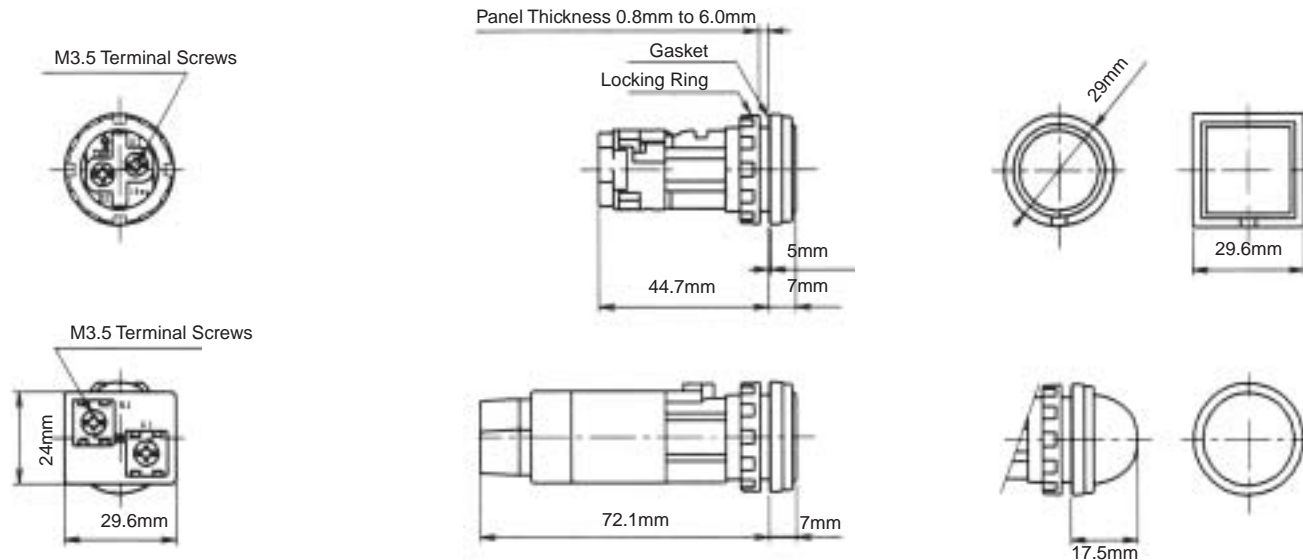

Dimensions con't

Jumbo Mushroom Pushbutton
HW1B-M5

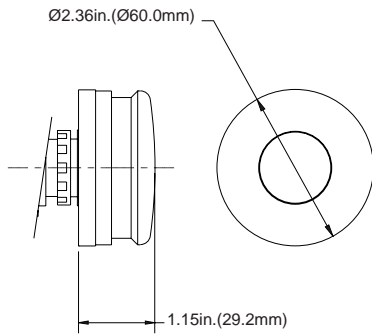

HW1B-V5

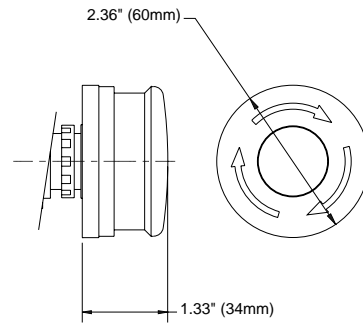

Illuminated Pushbuttons

Panel Thickness: 0.8mm to 6.0mm

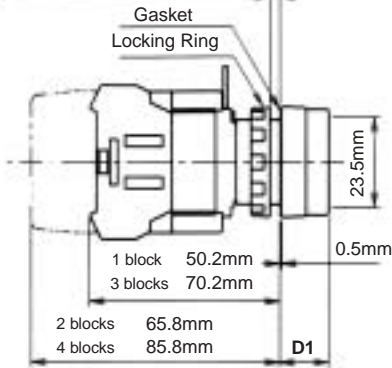

Mushroom

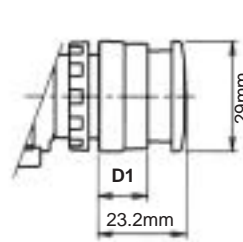

Extended with Full Shroud

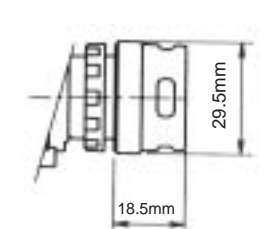

W/Transformer

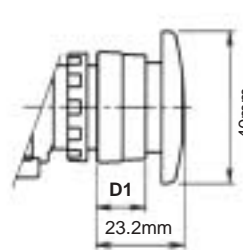
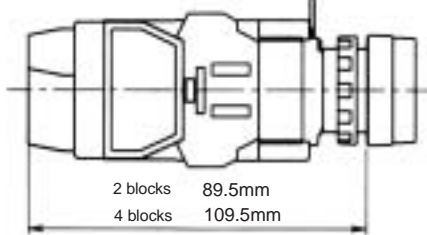

Extended

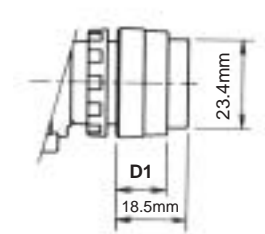

Round

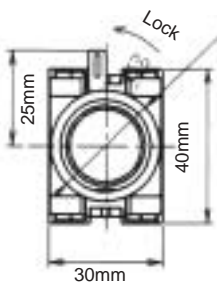

24V AC/DC

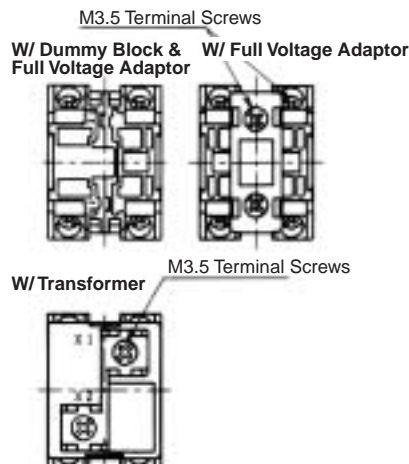

Square

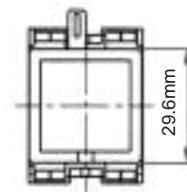

D1 = 0.51" 13mm



Dimensions con't

Unibody

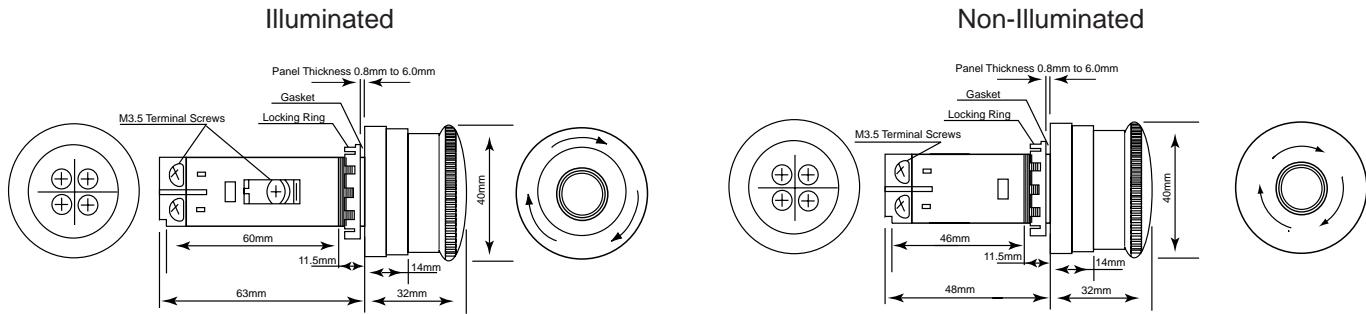

Selector Switches

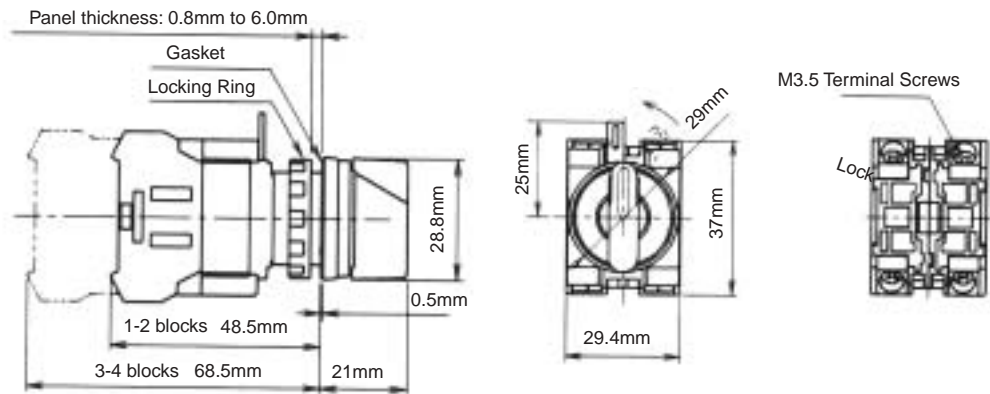

Illuminated Selector Switches

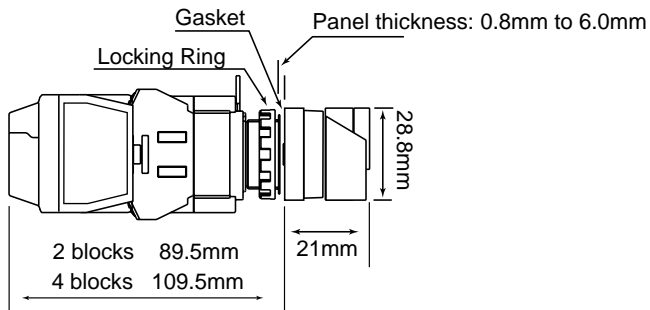

Pushlock Key Reset

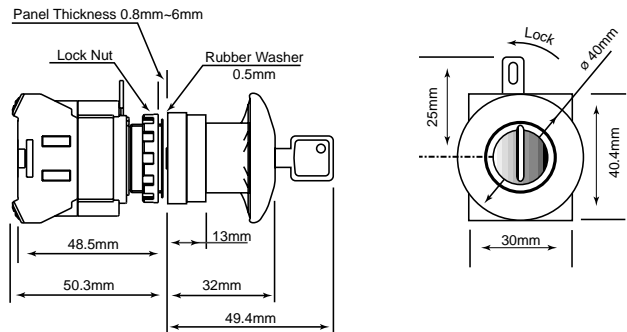

Key Switches

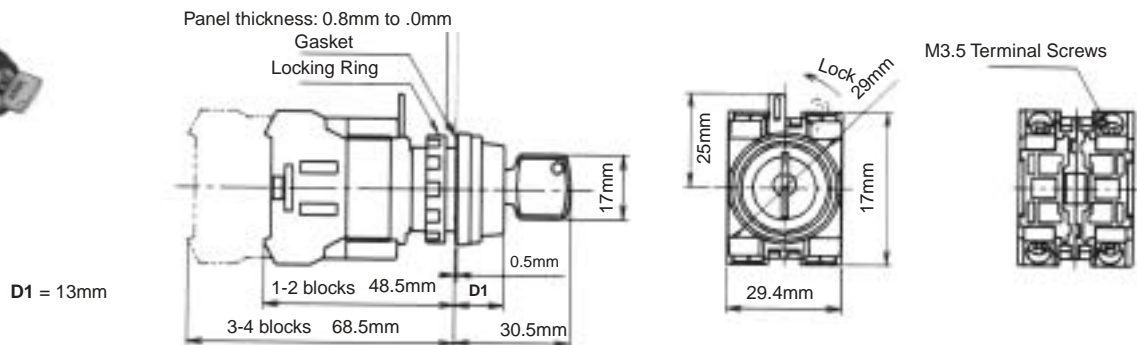

Dimensions con't

Accessories

LW9Z-BM
Metallic Mounting Hole Plug

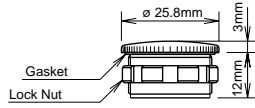

OB-31
Rubber Mounting Hole Plug

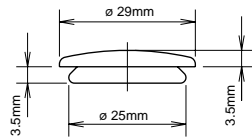

HW9Z-RL
Anti-Rotation Ring

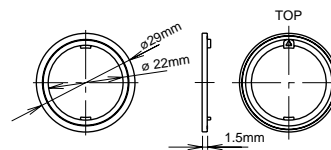

OR-55
Lamp/LED Removal Tool

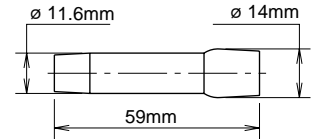

HW9Z-KL1
Padlock Cover

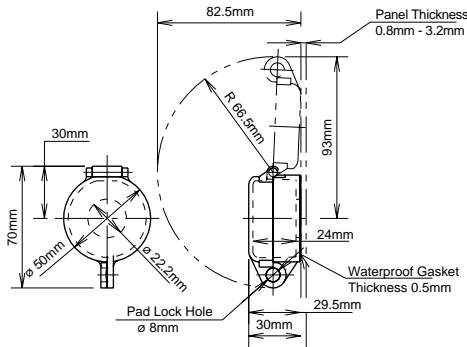

HW-VL1
Barrier

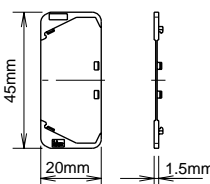

Mounting Hole Layout

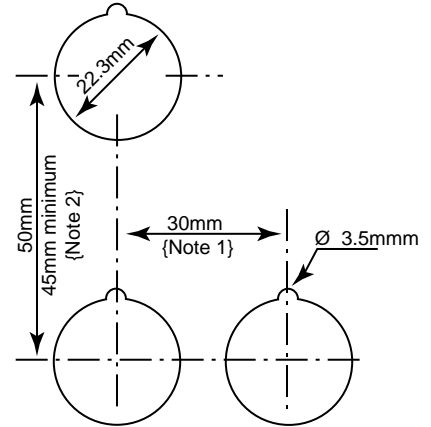

HWLS-TK1971
Safety Lever Lock

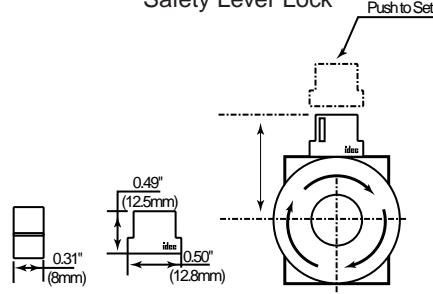

Note 1: Mushroom Button 40mm Type: 40mm or more

Note 2: Pilot Light: 30mm minimum

The values represent the minimum mounting centers when one stack of contact blocks is used. When two stacks or an illuminated unit is used, refer to the dimensions and consider wiring accessibility to determine minimum mounting centers.

HW9Z-KG1-TK2120

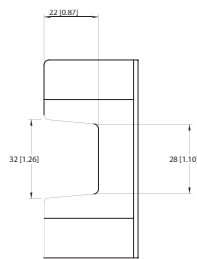
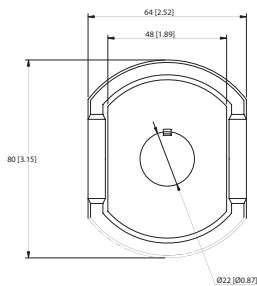

HW9Z-KG2-TK2120

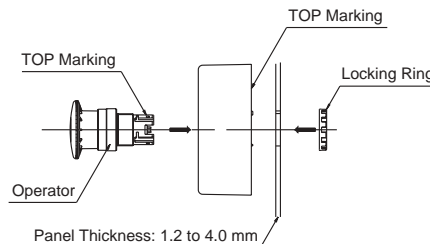
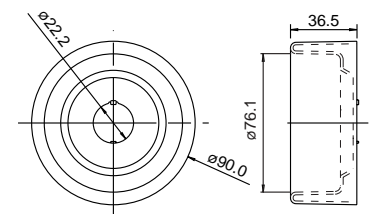
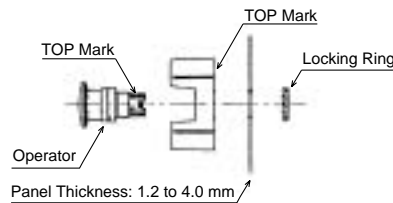
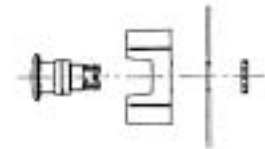
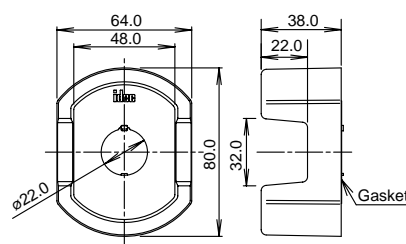

Specification Charts — HW Series

Rated Operational Power DC Voltage

Inductive

Resistive



Switches & Pilot Devices

DC Voltages

Voltage V	24	48	110
Current A	4	2	1.1

DC Voltages

Voltage V	24	48	110
Current A	8	4	2.2

AC Voltages

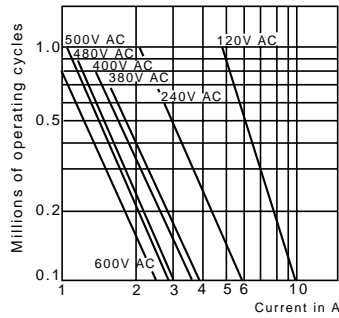

AC Voltages

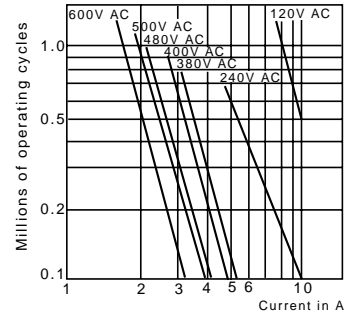

Conforming to IEC 947-5-1 Appendix C.
Utilization categories AC-15 and DC-13.
Operation rate: 1,800 op. hour
Load factor: 0.4 ± 0.05

Conforming to IEC 947-5-1 Appendix C.
Utilization categories AC-15 and DC-13.
Operation rate: 1,800 op. hour
Load factor: 0.9 ± 0.05

General Information

Information About LED Lamps

Light-emitting diodes (LEDs) are P–N junction semiconductors with mechanisms called “junction electro-luminescence.” Application of direct current results in radiation or emission of a monochromatic light.

Different semiconductor materials produce different wavelengths of light as shown below:

Specifications	Green	Gallium Phosphide (GaP)	5600 Å
	Yellow	Gallium Arsenide Phosphide (GaAsP)	5800 Å
	Amber	Gallium Arsenide Phosphide (GaAsP)	6300 Å
	Red	Gallium Arsenide Phosphide (GaAsP)	6600 Å
	Infrared	Gallium Arsenide (GaAs)	9000 Å

Advantages of Using LEDs

- LEDs are used when heat generated by incandescent lamps would damage nearby equipment or interfere with a precision process. This is particularly advantageous when multiple lights are grouped.
- LEDs can operate at low temperatures which would cause incandescent lamps to fail, since glass cracks during rapid cooling.
- LEDs consume 50 times less power than incandescent lamps, thereby reducing energy consumption.
- LEDs last 500 times longer than incandescent lamps. LEDs average a million hours (114 years) while incandescent lamps average 2000 hours.
- LEDs do not generally “blow out” unless subjected to a severe overvoltage. They exhibit a half-life type dimishment in brightness over time. After 50,000 hours (6 years) of use, IDEC LEDs will retain approximately half of their original intensity.
- IDEC’s SUPERBRIGHT LEDs have high visibility.
- LEDs require little or no maintenance because of long life and high reliability.

IDEC Recommendations

For optimum results, especially when using switches and pilot lights in operating environments which are conducive to overheating, use IDEC LED illuminated units. Transformers are available for use with incandescent illuminated units, which operate at lower voltages to avoid overheating.

When IDEC’s L-120L lamp is used, make sure ambient temperatures do not exceed 30°C (86°F). If a lamp from another supplier is used, it should be rated for less than 1.8 watts (15mA at 120V AC), with ambient temperatures as stated above.

Information About Incandescent Lamps

Filament-type incandescent lamps operate within the following parameters.

Light output and life expectancy depend on operating voltage. Light output varies to the 3rd or 4th power of the voltage. Life expectancy varies inversely to the 12th power of voltage. In other words, over-voltage of 5% reduces life expectancy by 50%. Under-voltage of 5% doubles life expectancy at the price of light output efficiency.

Inrush current (initial current through the filament) has an adverse effect on life expectancy. Cold resistance (room temperature) will have a more detrimental effect than hot resistance to inrush current. Life expectancy of incandescent lamps can be maximized by reducing occurrences of cold resistance to inrush current.

Continued intermittent flashing will significantly reduce life expectancy. When using an incandescent lamp with a tungsten filament, flashing will not reduce life expectancy as long as light output does not exceed that of steady burning.

When an incandescent lamp must withstand shock and vibration, use low voltage/high amperage (5–6V/60–120mA) lamps. These lamps have a short, thick filament with a high resonant frequency.

Provide cooling by using a heat sink, particularly when multiple incandescent lamps are grouped or when air circulation is limited. Make sure ambient temperatures do not exceed 100°C (212°F) for maximum life of incandescent lamps.

Comparison: LED vs. Incandescent Lamps

	Superbright LEDs	Incandescent	
Characteristics	Heat Dissipation	Very Low	High
	Life Expectancy	Very Long	Short
	Reliability	Very High	Low
	Mechanical Strength	Not Susceptible	Susceptible to Shock/Vibration
	Maintenance Required	Negligible	Frequent
	Operation at Low Temps.	Possible	Not Possible
	Inrush Current	Negligible	Very Large
	Voltage Effects on Life	Insignificant	Significant
	Brightness	Slightly Less	Slightly More

Ordering Information

1. IDEC offers assembled and sub-assembled switches and pilot lights for your convenience. In some cases there is a cost difference, with sub-assembled units costing slightly less. Since assembled units are custom made to your order, a couple of days for assembly is added to delivery. To minimize delivery or inventory requirements, it is recommended that switches and pilot lights be ordered as sub-components.
2. When ordering pilot lights or illuminated pushbuttons, make sure to specify the color code in place of the asterisk in the part number, (LED or incandescent lamp included). Spare lamps can be ordered and are listed with sub-assembly components.
3. Accessories, such as locking ring wrench, lens removal tool, and lamp holder, are available to make installation and assembly easier. IDEC recommends using these accessories and is not responsible for damage as a result of using the wrong tool.
4. Marking plates are available for switches and pilot lights which feature a flat lens. Printed mylar (not included) can also be inserted under lens for labeling purposes.
5. Nameplates are available for TW, 7/8" (22mm), HW 7/8" (22mm), and TWTD series, Ø1-13/64" (30mm). For prompt delivery, order standard legends. Custom engraving is also offered for an additional charge.

Installation and Operation

1. Use the appropriate lamp holder to remove or install LED or incandescent lamps. Using pliers will damage the lamp.
2. When mounting switches and pilot lights into a panel, use locking ring wrench. Using pliers or tightening excessively will damage the locking ring.
3. A series, 21/64" (8mm), can be mounted on a panel 0.019" (0.5mm) to 0.236" (6mm) thick.
4. LW 7/8" (22mm), TW, 7/8" (22mm), and TWTD series, Ø1-13/64" (30mm), feature an adjustment ring for mounting on a panel 0.038" (1mm) to 0.236" (6mm) thick. Using a nameplate or an anti-rotation ring adds 0.031" (0.8mm) to the panel thickness.
5. When applicable, solder terminals within 20W/5sec or 260°/3sec without exerting external force to the terminals. Use a non-corrosive resin liquid flux.
6. The operating voltage for LED units represents a complete DC value. When using a pulsing voltage, such as a full-wave rectification, keep peak currents within the forward current I_f . Peak currents exceeding I_f may shorten the life of the LED lamp.
7. To avoid a short circuit, never connect NO and NC contacts to different voltages or power sources.
8. Optimum performance of TW and TWTD illuminated pushbuttons, selector switches, and pilot lights is obtained with IDEC LED and incandescent lamps.
9. For maximum life of incandescent lamps (approximately 2000 hours), use within the rated operating voltage. If it is necessary to use a higher voltage, keeping ambient temperature below 30°C (86°F) will help prolong the life of an incandescent lamp.



If excessive voltage is applied (over 50V), the lamp may blow and the lens holder may pop out.