

# GT32 Series

— Shielded connector for high speed transmission / USB3.0, HDMI1.4 —

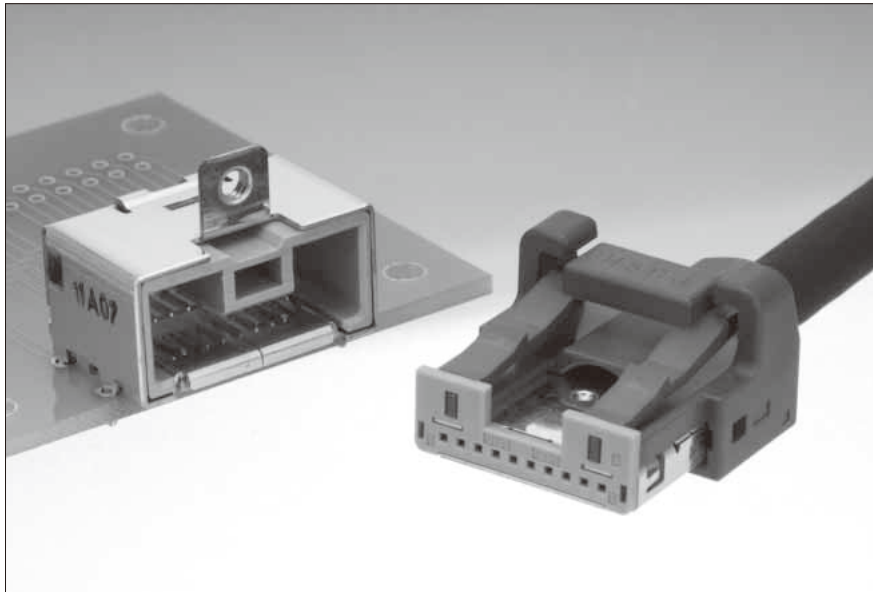

GT5

GT13

GT16

PO5G

GT19

GT21

GT26

GT36

GT11

GT17

GT32

GT3

GT7

GT10

GT18W

GT25

GT8E

GT9

GT15

For Network, High speed communication

## ■ Features

- Full shielded structure
- Suitable for in-vehicle shielded connectors

## ■ Applications

In-vehicle data communication, etc.  
(10-pos : USB3.0 support)  
(19-pos : HDMI1.4 equivalent signal support)

## F connector

### Center terminal

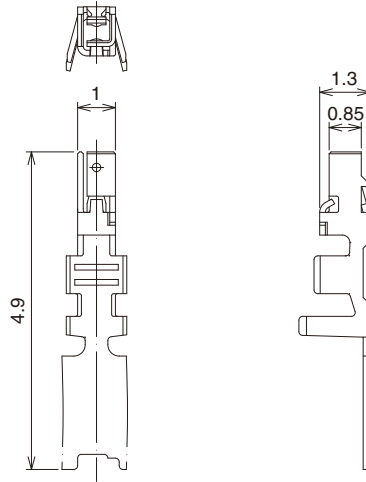
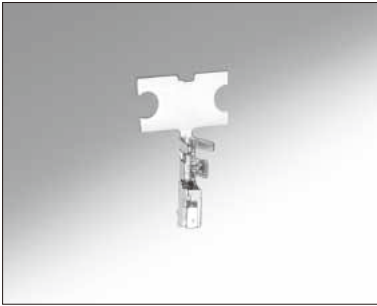

Part No.	HRS No.	Material	Plating	Conductor Size (AWG)	Outer Diameter	Packaging	RoHS
GT32-2428SCF	782-0007-8	Copper alloy	Tin plating	24 to 28 AWG	φ 0.8 to 1.0	10,000 pcs/reel	YES

## 10-pos straight plug connector

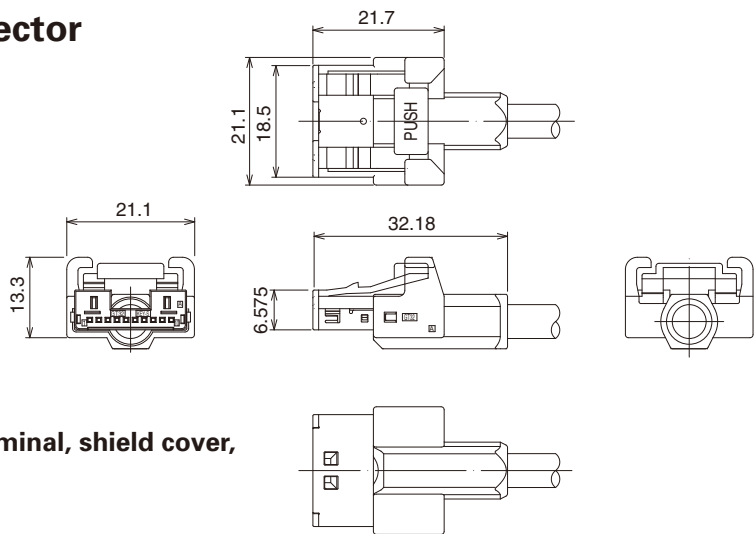
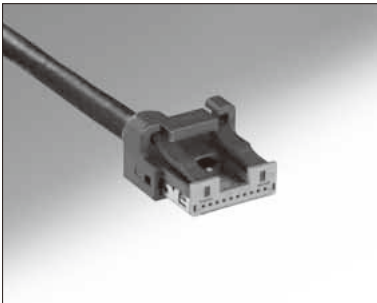

◆ This product consists of six parts.  
(Housing, S insulation case, outer terminal, shield cover, shield plate, center terminal)

### Housing

Part No.	HRS No.	Material	Color	Packaging	RoHS
GT32-10S-HU	782-0003-7	PBT	Dark Gray	1	YES

### S insulation case

Part No.	HRS No.	Material	Color	Packaging	RoHS
GT32-10S-1.5C	782-0002-4	PBT	Light Gray	1	YES

### Outer terminal

Part No.	HRS No.	Material	Plating	Outer Diameter	Packaging	RoHS
GT32-10S-6CF	782-0004-0	Copper alloy	Tin plating	φ 5.4 to 5.8	1	YES

### Shield cover

Part No.	HRS No.	Material	Plating	Packaging	RoHS
GT32-10S-SC	782-0005-2	Brass	Tin plating	1	YES

### Shield plate

Part No.	HRS No.	Material	Plating	Packaging	RoHS
GT32-10S-SP	782-0006-5	Brass	Tin plating	1	YES

### Center terminal

Part No.	HRS No.	Material	Plating	Conductor Size (AWG)	Outer Diameter	Packaging	RoHS
GT32-2428SCF	782-0007-8	Copper alloy	Tin plating	24 to 28 AWG	φ 0.8 to 1.0	10,000 pcs/reel	YES

## Mating table

Color	Cable connector	Board connector
Light Gray	GT32-10S-ASSY	Right-angle type GT32-10P-1.5H

- GT5
- GT13
- GT16
- PO5G
- GT19
- GT21
- GT26
- GT36
- For Network, High speed communication
- GT11
- GT17
- GT32**
- GT3
- GT7
- GT10
- GT18W
- GT25
- GT8E
- GT9
- GT15

## ■ 10-pos board connector (right-angle SMT type)

● M2.5 screw flange type

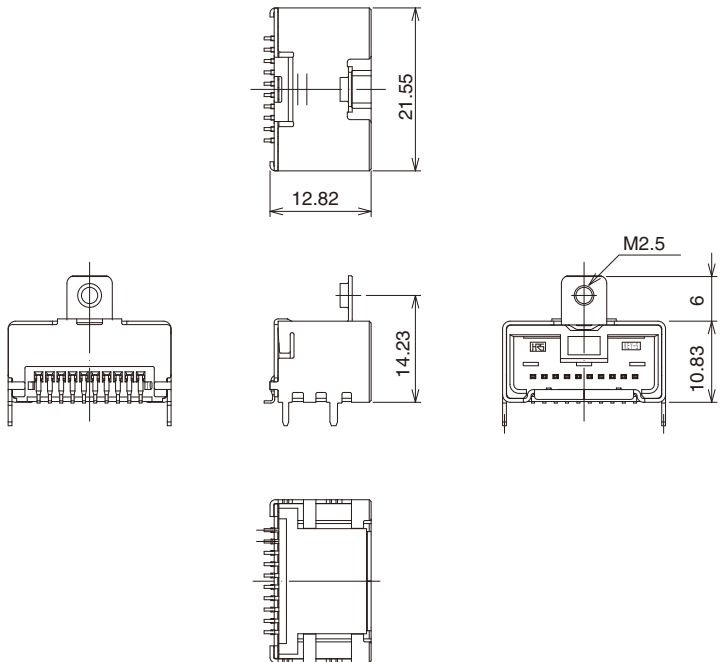
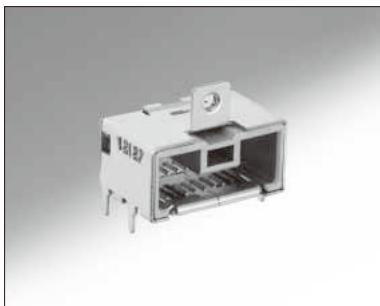

Part No.	HRS No.	Color	Material/Plating	Packaging	RoHS
GT32-10P-1.5H	782-0001-1	Light Gray	Housing : PPS Center terminal : Brass/Tin plating Outer terminal : Copper alloy/Tin plating	1	YES

Jun. 1. 2020 Copyright 2020 HRS ELECTRIC CO., LTD. All Rights Reserved.  
 For Network, High speed communication

GT5  
 GT13  
 GT16  
 PO5G  
 GT19  
 GT21  
 GT26  
 GT36  
 GT11  
 GT17  
**GT32**  
 GT3  
 GT7  
 GT10  
 GT18W  
 GT25  
 GT8E  
 GT9  
 GT15

## ■ 19-pos straight connector

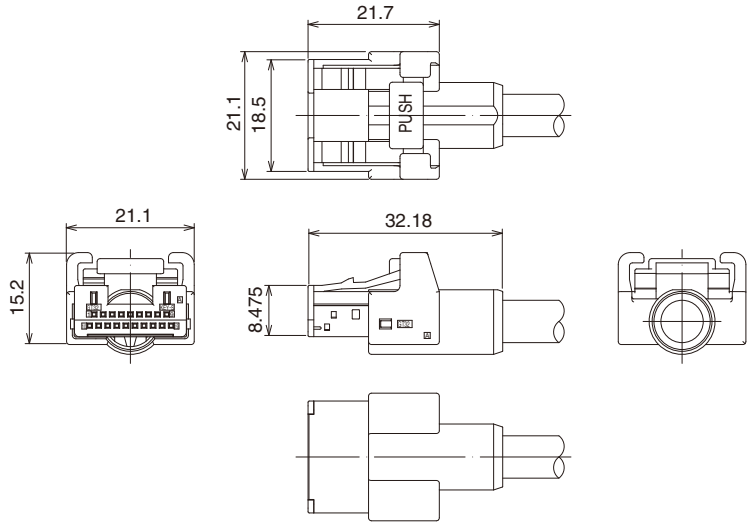
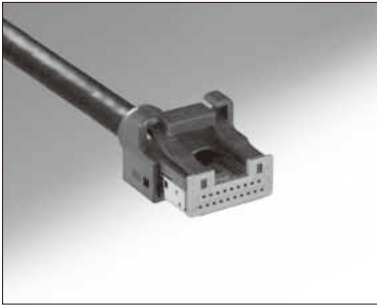

◆ This product consists of six parts.  
 (Housing, S insulation case A, S insulation case B, outer terminal, shield cover, center terminal)

### ● Housing

Part No.	HRS No.	Material	Color	Packaging	RoHS
GT32-19DS-HU	782-0013-0	PBT	Dark Gray	1	YES

### ● S insulation case A

Part No.	HRS No.	Material	Color	Packaging	RoHS
GT32-19DS-0.75CA	782-0010-2	PBT	Light Gray	1	YES

### ● S insulation case B

Part No.	HRS No.	Material	Color	Packaging	RoHS
GT32-19DS-0.75CB	782-0014-3	PBT	Light Gray	1	YES

### ● Outer terminal

Part No.	HRS No.	Material	Plating	Outer Diameter	Packaging	RoHS
GT32-19DS-7CF	782-0011-5	Copper alloy	Tin plating	φ 6.8 to 7.2	1	YES

### ● Shield cover

Part No.	HRS No.	Material	Plating	Packaging	RoHS
GT32-19DS-SC	782-0012-8	Brass	Tin plating	1	YES

### ● Center terminal

Part No.	HRS No.	Material	Plating	Conductor Size (AWG)	Outer Diameter	Packaging	RoHS
GT32-2428SCF	782-0007-8	Copper alloy	Tin plating	24 to 28 AWG	φ 0.8 to 1.0	10,000 pcs/reel	YES

## ◆ Mating table

Color	Cable connector	Board connector	
		Right-angle type	DIP type
Light Gray	GT32-19DS-ASSY	GT32-19DP-0.75H	GT32-19DP-0.75DSA

GT5

GT13

GT16

PO5G

GT19

GT21

GT26

GT36

GT11

GT17

GT32

GT3

GT7

GT10

GT18W

GT25

GT8E

GT9

GT15

For Network, High speed communication

## ■ 19-pos board connector (right-angle SMT type)

### ● M2.5 screw flange type

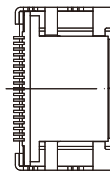
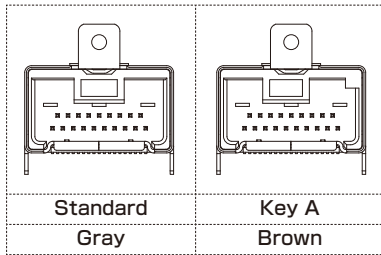
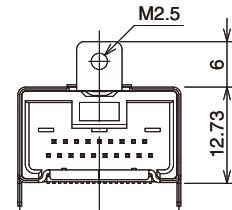
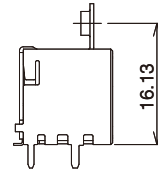
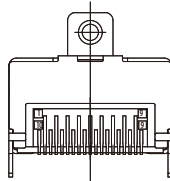
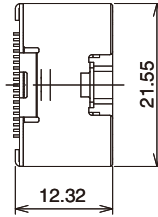
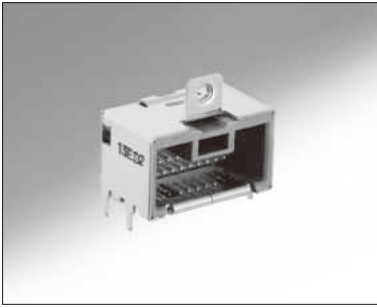

Part No.	HRS No.	Color	Material/Plating	Packaging	RoHS
GT32-19DP-0.75H	782-0009-3	Gray	Housing : PA Center terminal : Brass/Tin plating Outer terminal : Copper alloy/Tin plating	1	YES
GT32-19DP-0.75H(A)	782-0015-6	Brown			

## ■ 19-pos board connector (straight DIP type)

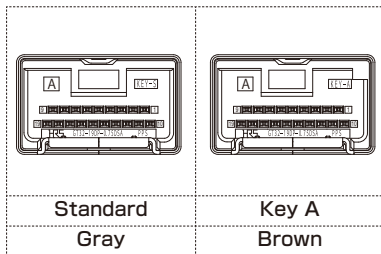
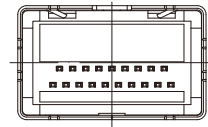
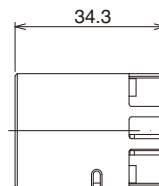
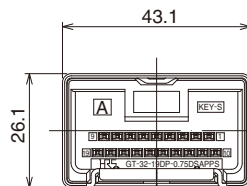
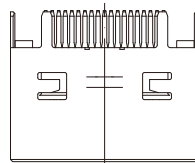

Part No.	HRS No.	Color	Material/Plating	Packaging	RoHS
GT32-19DP-0.75DSA	782-0037-9	Gray	Housing : PPS Center terminal : Brass/Tin plating Outer terminal : Copper alloy/Tin plating	1	YES
GT32-19DP-0.75DSA (A)	782-0045-7	Brown			

## ◆ Crimping tools

Operation manuals are available for each crimp tool. Please contact sales personnel.

### ● Automatic Crimping Machine

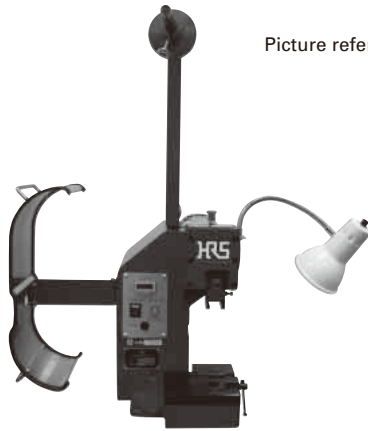

Picture reference only

#### Specifications

Item	Specification	Remarks
Press capacity	1.5Ton	
Stroke length	30mm	
Number of strokes	200spm (50Hz)	240spm (60Hz)
Weight	75kg	
Motor	0.2kW	AC100V
Crimping speed	2000 to 4000 pcs/hour	

Part No. CM-105C

Note : Please refer to the table below for applicator product numbers.

#### Applicator (for use with the automatic crimping machine)

Terminal Product No.	Terminal HRS No.	Tool Product No.	Tool HRS No.
GT32-2428SCF	782-0007-8	AP105-GT32-2428S	901-5223-2 00

Note 1 : The crimp height is to be set for each cable type. Please request your contact person for details.

Note 2 : The P/N for applicator/tool may differ from the above P/N depending on the cable specification.

#### Special terminal insertion tool for GT32-10S-1.5C

Terminal Product No.	Terminal HRS No.	Tool No.	Tool HRS No.
GT32-2428SCF	782-0007-8	GT32-CON/PR-MD	902-5125-0

\* This product is used only to insert GT32-2428SCF terminal into S insulation case GT32-10S-1.5C.

Please note that this product cannot be used for other terminals and insulation cases.

### ● Hand press

Hand press

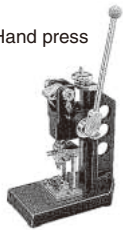

Product No. HOS-7

#### Outer terminal applicator (for hand press mounting)

Product Part No.	Product HRS No.	Tool Part No.	Tool HRS No.
GT32-10S-6CF	782-0004-0	GT32-10S-6/CR-MP	902-5118-4 00
		GT32-10S-6/CR-MP(01)	902-5118-4 01
GT32-19DS-7CF	782-0011-5	GT32-19DS-7/CR-MP	902-5124-7 00
		GT32-19DS-7/CR-MP(01)	902-5124-7 01

Note 1 : (01) version is to be supplied with the hand press "HOS-7".

Note 2 : The crimp height is to be set for each cable type. Please request your contact person for details.

Note 3 : The P/N for applicator/tool may differ from the above P/N depending on the cable specification.