

0.5mm Pitch, 5.8mm above the board, vertical connectors for FPC

FH40 Series

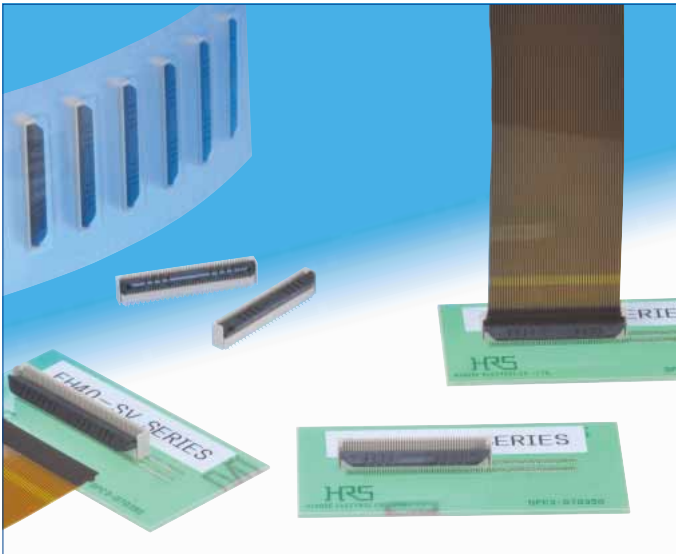

●Strong actuator construction

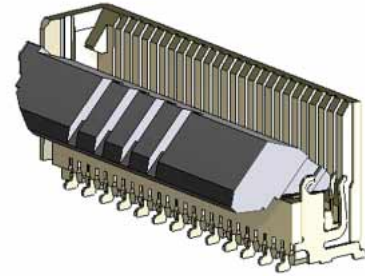

Fig.1

■Features

1. Reduction in connection man-hours (30% reduction compared to our conventional item)

Our unique actuator form enables the completion of both FPC insertion ~ joint in the same motion.

2. Prevention of half and diagonal joints

The side catcher for FPC positioning ensures accurate FPC insertion.

3. Durable structure and no lost actuator

The unique terminal form means the actuator is retained, even under rough operation conditions.

4. One-finger operation of the actuator

Proven (in several other Hirose's connectors!) Flip-Lock rotating actuator assures reliable mechanical and electrical connection with FPC, confirming it with a definite tactile feel.

5. Accepts standard FPC thickness

0.3mm thick standard Flexible Printed Circuit (FPC) can be used.

6. Board placement with automatic equipment

Flat upper surface and tape and reel packaging facilitate vacuum pick-up and placement. Standard reel packaging contains 1,000 connectors.

7. Halogen-free *

*As defined by IEC61249-2-21
Br-900ppm maximum, Cl-900ppm maximum,
Cl + Br combined-1,500ppm maximum

●Simple FPC insertion

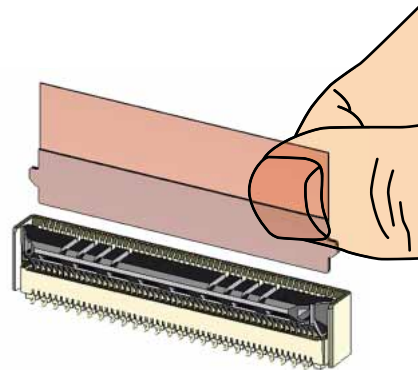

Fig.2

●Lock

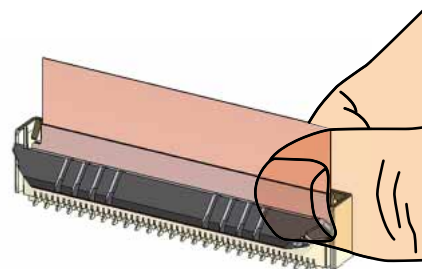

Fig.3

Product Specifications

Ratings	Current rating : 0.5A DC(Note 1) Voltage rating : 50Vrms AC	Operating Temperature Range : -40 to +105°C (Note 2) Operating Humidity Range : Relative humidity 90% max. (No condensation)	Storage Temperature Range : -10 to +50°C (Note 2) Storage Humidity Range : Relative humidity 90% max. (No condensation)
---------	--	--	---

Recommended FPC Thickness	0.3±0.05mm, Gold plated contact pads
---------------------------	--------------------------------------

Item	Specification	Conditions
1. Insulation resistance	500MΩ min.	100V DC
2. Withstanding voltage	No flashover or insulation breakdown	150Vrms AC / 1 minute
3. Contact resistance	50mΩ max. Including FPC and FFC conductor resistance	1mA, (DC or 1000Hz)
4. Durability	Contact resistance : 50mΩ max. No damage, cracks, or parts dislocation	20 cycles
5. Vibration	No electrical discontinuity of 1μs or longer Contact resistance: 50mΩ max. No damage, cracks, or parts dislocation	Frequency : 10 to 55Hz, single amplitude of 0.75mm, 10 cycles in each of the 3 axis.
6. Shock	No electrical discontinuity of 1μs or longer No damage, cracks, or parts dislocation Contact resistance : 50mΩ max.	Acceleration of 981m/s ² , 6ms duaration, sine half-wave wavefrom 3 cycles in each of the 3 axis
7. Humidity(Steady state)	Contact resistance : 50mΩ max. Insulation resistance : 50MΩ min. No damage, cracks, or parts dislocation	96 hours at 40°C and humidity of 90 to 95%
8. Temperature Cycle	Contact resistance : 50mΩ max. Insulation resistance : 50MΩ min. No damage, cracks, or parts dislocation	Temperature : -40°C → +15°C to +35°C → +105°C → +15°C to +35°C Time : 30 → 2 to 3 → 30 → 2 to 3(minutes) 5 cycles
9. Resistance to Soldering heat	No deformation of components affecting performance	Reflow : At the recommended temperature profile Manual soldering : 350°C±5°C for 5 seconds

Note 1 : When passing the current through all of the contacts, use 70% of the rated current.

Note 2 : Includes temperature rise caused by current flow.

Note 3 : The term "storage" refers to products stored for a long period prior to mounting and use.

The operating temperature and humidity range covers the non-conducting condition of installed connectors in storage, shipment or during transportation after board mounting.

Materials / Finish

Part	Material	Finish	Remarks
Insulator	LCP	Color : Beige	UL94V-0
		Color : Black	
Contact	Phosphor bronze	Gold plated	_____

Product Number Structure

Refer to the chart below when determining the product specifications from the product number.

Please select from the product numbers listed in this catalog when placing orders.

FH 40 - 50S - 0.5 SV (99)

① ② ③ ④ ⑤ ⑥

① Series Name	: FH
② Series No.	: 40
③ Number of positions	: 10 to 80
④ Contact pitch	: 0.5mm
⑤ SV	: SMT vertical mounting type
⑥ Specifications	standard...Partial gold plating 1,000pcs/reel (99)...Partial gold plating 500pcs/reel

Connector Dimensions

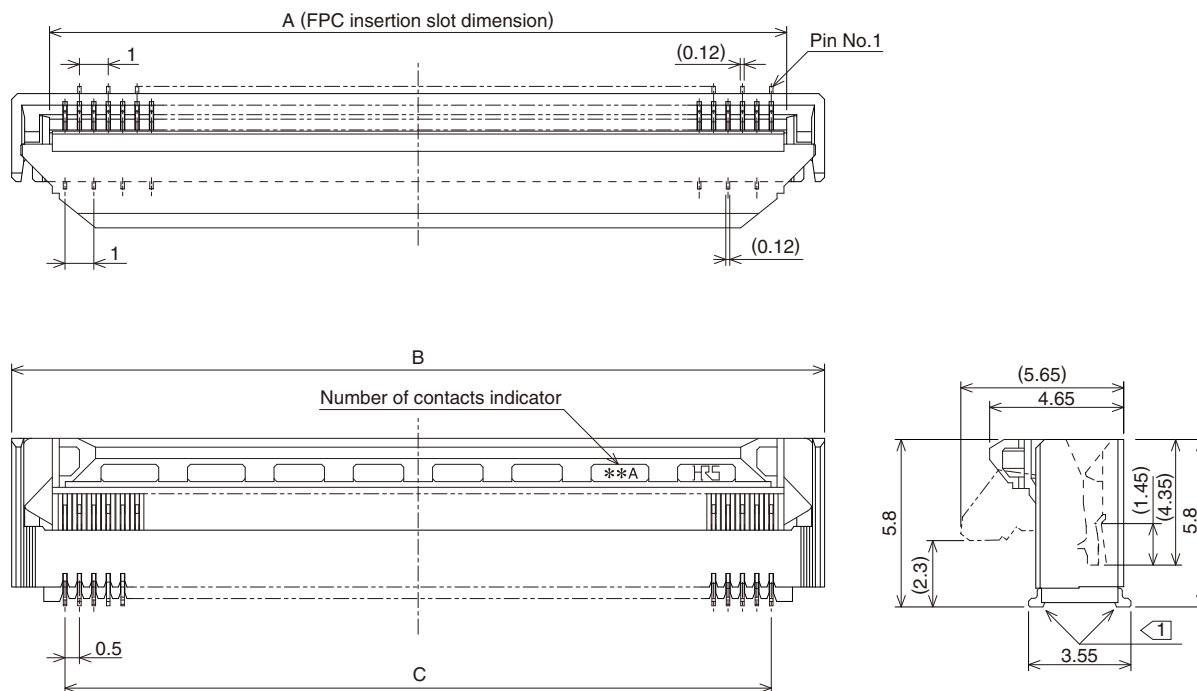

Note 1: The coplanarity of each terminal lead within specified dimension is 0.1mm Max.

Note 2 : Packaged on tape and reel only. Check packaging specification.

Note 3 : Slight variations in color of the plastic compounds do not affect form, fit or function of the connector.

Note 4 : After reflow, the terminal plating may change color, however this does not represent a quality issue.

Unit : mm

Part No.	HRS No.	No. of Contacts	A	B	C
FH40-10S-0.5SV	580-2104-6	10	5.57	8.2	4.5
FH40-20S-0.5SV	580-2105-9	20	10.57	13.2	9.5
FH40-24S-0.5SV	580-2106-1	24	12.57	15.2	11.5
FH40-30S-0.5SV	580-2108-7	30	15.57	18.2	14.5
FH40-40S-0.5SV	580-2107-4	40	20.57	23.2	19.5
FH40-45S-0.5SV	580-2101-8	45	23.07	25.7	22
FH40-50S-0.5SV	580-2100-5	50	25.57	28.2	24.5
FH40-60S-0.5SV	580-2109-0	60	30.57	33.2	29.5
FH40-64S-0.5SV	580-2102-0	64	32.57	35.2	31.5
FH40-80S-0.5SV	580-2103-3	80	40.57	43.2	39.5

Note 1 : Tape and reel packaging (1,000 pcs/reel, 500 pcs/reel).

Order by number of reels.

◆ Recommended PCB mounting pattern and metal mask dimensions

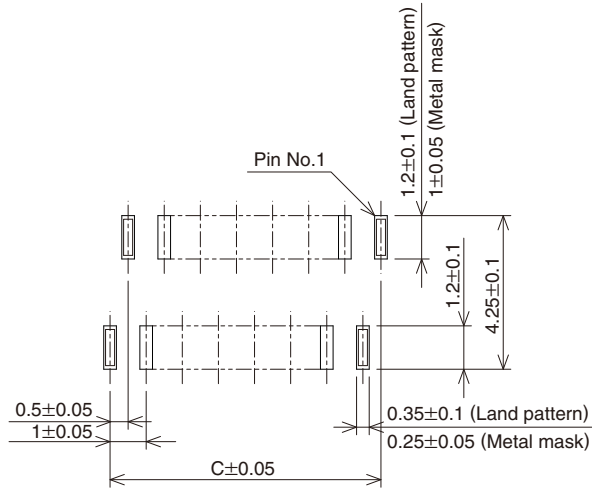

Recommended metal mask thickness : $t=0.15$

◆ Recommended FPC Dimensions

It is not recommended to mate FPC without tabs to this connector.

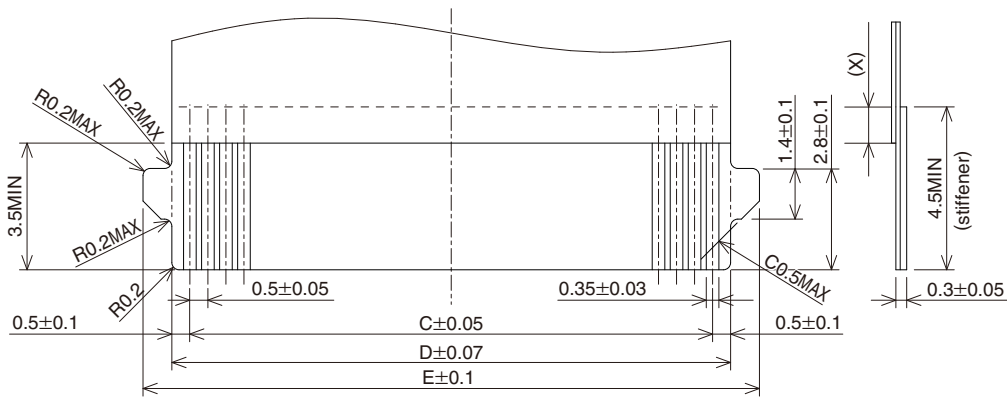

Note 1 : Stiffener dimension should be 3.5mm min., and X dimension should be 0.5mm for improved flexibility of FPC.

Unit : mm

Part No.	HRS No.	No. of Contacts	C	D	E
FH40-10S-0.5SV	580-2104-6	10	4.5	5.5	7.1
FH40-20S-0.5SV	580-2105-9	20	9.5	10.5	12.1
FH40-24S-0.5SV	580-2106-1	24	11.5	12.5	14.1
FH40-30S-0.5SV	580-2108-7	30	14.5	15.5	17.1
FH40-40S-0.5SV	580-2107-4	40	19.5	20.5	22.1
FH40-45S-0.5SV	580-2101-8	45	22	23	24.6
FH40-50S-0.5SV	580-2100-5	50	24.5	25.5	27.1
FH40-60S-0.5SV	580-2109-0	60	29.5	30.5	32.1
FH40-64S-0.5SV	580-2102-0	64	31.5	32.5	34.1
FH40-80S-0.5SV	580-2103-3	80	39.5	40.5	42.1

◆ Recommended FPC construction

1. Using Single-sided FPC

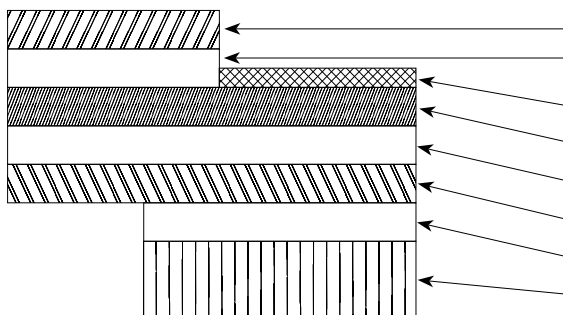

FPC : Flexible Printed Circuit

Material Name	Material	Material Thickness (μm)
Covering film layer	Polyimide 1 mil thick.	(25)
Cover adhesive		(25)
Surface treatment	0.2μm thick gold plated over 1 to 5μm nickel underplating	3
Copper foil	Cu 1oz	35
Base adhesive	Thermosetting adhesive	25
Base film	Polyimide 1 mil thick	25
Reinforcement material adhesive	Thermosetting adhesive	40
Stiffene	Polyimide 7 mil thick	175
Total		303

2. Using Double-sided FPC

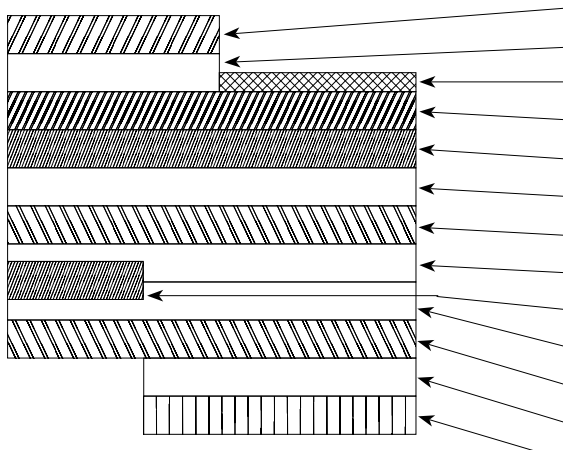

FPC : Flexible Printed Circuit

Material Name	Material	Material Thickness (μm)
Covering film layer	Polyimide 1 mil thick.	(25)
Cover adhesive		(25)
Surface treatment	0.2μm thick gold plated over 1 to 5μm nickel underplating	3
Through-hole copper	Cu	15
Copper foil	Cu 1/2oz	18
Base adhesive	Thermosetting adhesive	18
Base film	Polyimide 1 mil thick	25
Base adhesive	Thermosetting adhesive	18
Copper foil	Cu 1/2oz	(18)
Cover adhesive	Thermosetting adhesive	25
Covering film layer	Polyimide 1 mil thick.	25
Reinforcement material adhesive	Thermosetting adhesive	50
Stiffener	Polyimide 4 mil thick	100
Total		297

* To prevent release of the FPC due to its bending, use of the double sided FPC with copper foil on the back side is NOT RECOMMENDED.

3. Using FFC

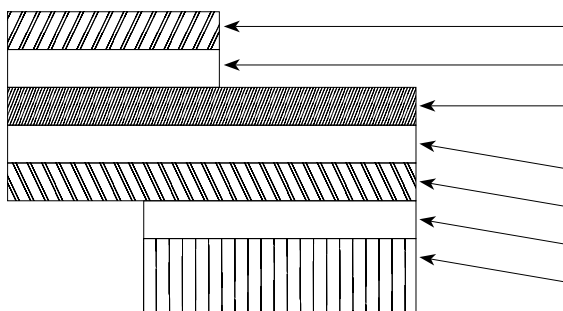

FFC : Flexible Flat Cable

Material Name	Material	Thickness (μm)
Polyester film		12
Adhesive	Polyester thermoplastic type	30
Annealed copper foil (Gold plating over nickel under plating)		35
Adhesive	Polyester	30
Polyester		12
Adhesive	Polyester	30
Stiffener	Polyester	188
Total		295

* Actual tolerance of the thickness is approximately ±20μm.

1. This specification is a recommendation for the material configuration of the FPC/FFC (t=0.3 ±0.05mm) for the FH40 series connectors.
2. Please contact the FPC/FFC manufacturer for the material configurations of their FPC/FFC.

May.1.2020 Copyright 2020 HIROSE ELECTRIC CO., LTD. All Rights Reserved.

◆ Packaging Specification

● Embossed Carrier Tape Dimensions (Tape width to 24mm max.)

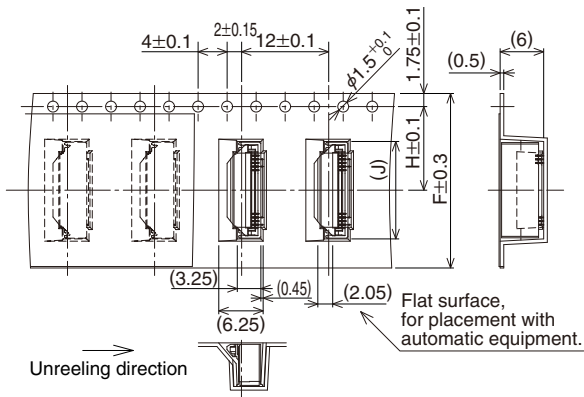

● Embossed Carrier Tape Dimensions (Tape width 32mm min.)

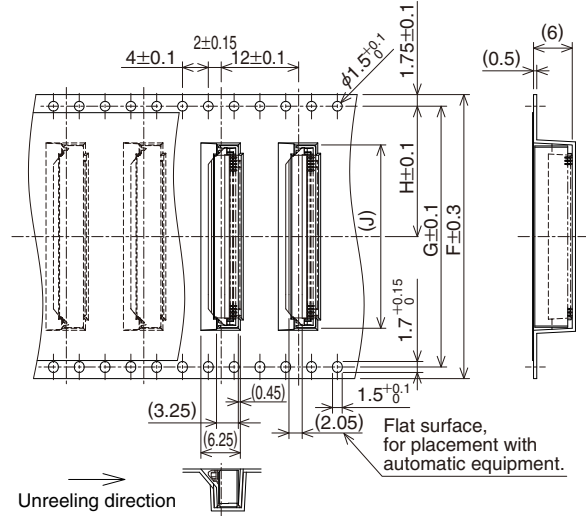

● Reel Dimensions

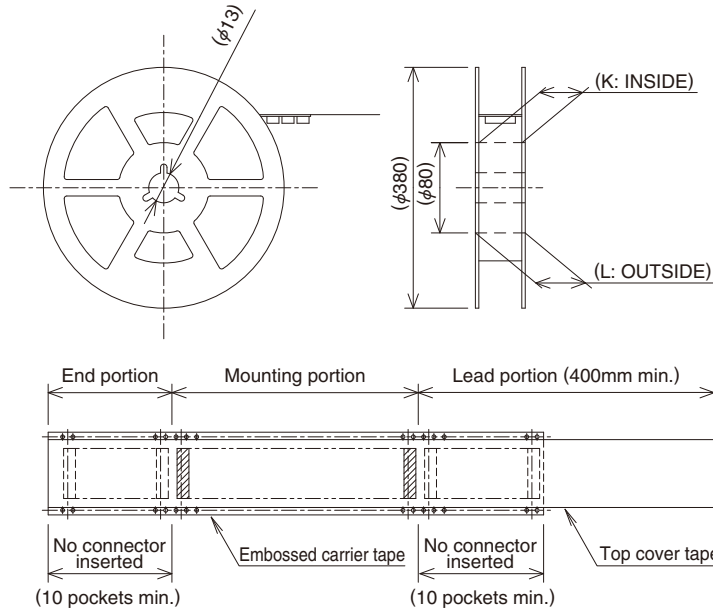

◆ Packaging Specification Dimensions

Unit : mm

Part No.	HRS No.	No. of Contacts	F	G	H	J	K	L
FH40-10S-0.5SV	580-2104-6	10	16	—	7.5	8.4	17.4	21.4
FH40-20S-0.5SV	580-2105-9	20	24	—	11.5	13.4	25.4	29.4
FH40-24S-0.5SV	580-2106-1	24				15.4		
FH40-30S-0.5SV	580-2108-7	30	32	28.4	14.2	18.4	33.4	37.4
FH40-40S-0.5SV	580-2107-4	40	44	40.4	20.2	23.4	45.4	49.4
FH40-45S-0.5SV	580-2101-8	45				25.9		
FH40-50S-0.5SV	580-2100-5	50				28.4		
FH40-60S-0.5SV	580-2109-0	60	56	52.4	26.2	33.4	57.4	61.4
FH40-64S-0.5SV	580-2102-0	64				35.4		
FH40-80S-0.5SV	580-2103-3	80				43.4		

Note 1 : Tape and reel packaging (1,000 pcs/reel).

◆ Temperature Profile

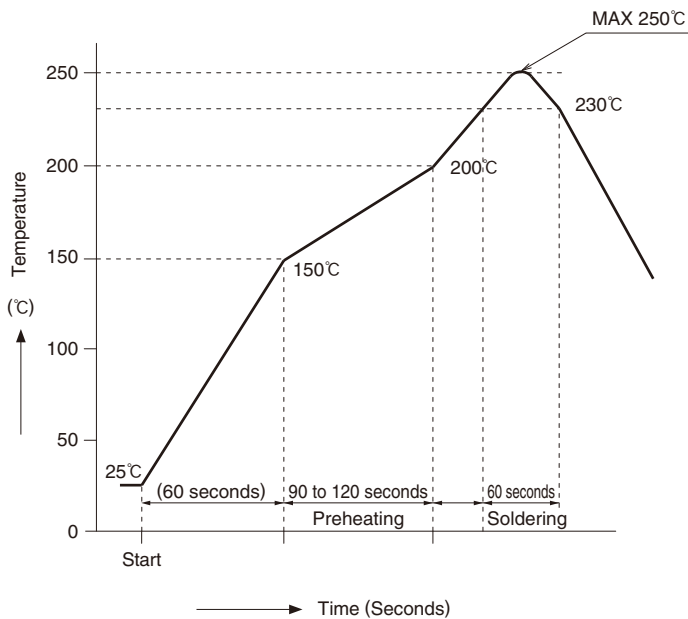



HRS test conditions

Solder method : Reflow, IR/hot air
 Environment: : Room air
 Solder composition: Paste, 96.5%Sn/3%Ag/0.5%Cu
 (Senju Metal Industry, Co., Ltd.'s
 Part Number : M705-GRN360-K2-V)
 Test board : Glass epoxy 30mm×66mm×0.8mm thick
 Land dimensions : 0.35mm×1.2mm
 Metal mask : 0.25×1.0×0.15mm thick

The temperature profiles shown are based on the above conditions.

In individual applications the actual temperature may vary, depending on solder paste type, volume / thickness and board size / thickness. Consult your solder paste and equipment manufacturer for specific recommendations.

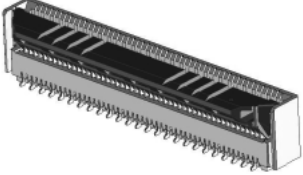
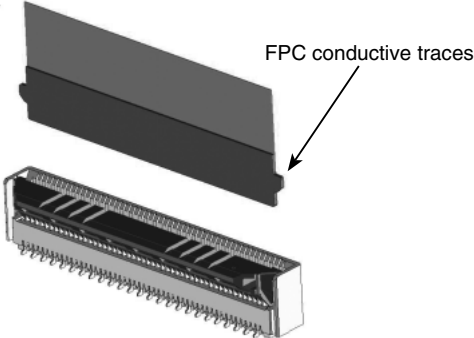
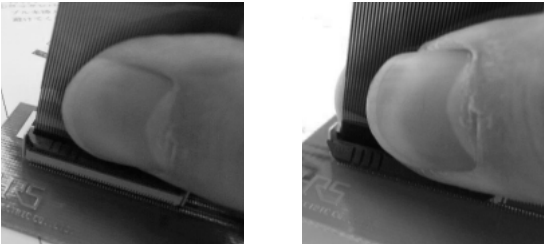
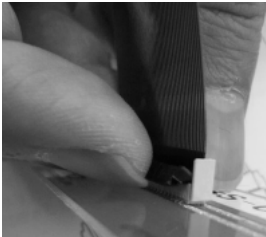
◆ Connector Operation and Precautions

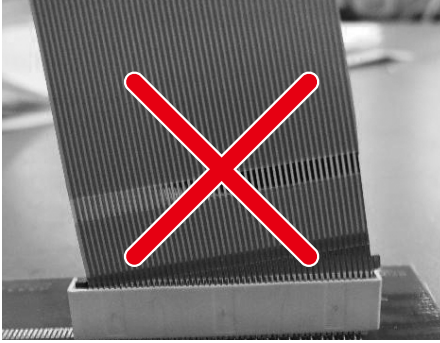
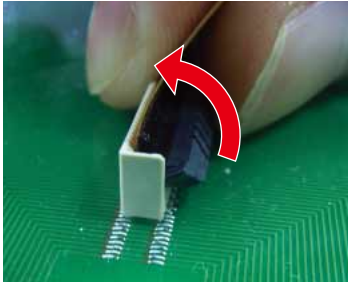
Operation	Precautions
<p>1. FPC Termination procedure.</p> <p>① Verify that the actuator is positioned upright. If the actuator has rotated to the side, carefully rotate it upright.</p>  <p>② Insert the FPC vertically in the connector slot assuring that the conductive traces of the FPC are facing away from the actuator.</p>  <p>③ Press down the actuator in the direction shown.</p>  <p>2. FPC Removal</p> <p>① Rotate the actuator upward and withdraw the FPC.</p> 	<p>① Avoid forcing the actuator up or down without the FPC inserted.</p>  <p>② Application of excessive force to the inserted FPC may cause damage to connector and may affect the reliability of electrical connection.</p>  <p>Do not insert the FPC diagonally. Doing so will result in the corners of the FPC catching on the contacts and will cause deformation of the contacts.</p> <p>③ Disengage the actuator to release the lock and extract the FPC/FFC (refer to the picture below). By utilizing your thumb and index finger, you can easily manipulate the actuator to disengage the lock.</p>  <p>During the design phase of the PCB layout, make sure to incorporate enough space to engage/disengage the actuator on this connector when inserting or removing the FPC.</p>



HIROSE ELECTRIC CO.,LTD.

2-6-3, Nakagawa Chuoh, Tsuzuki-Ku, Yokohama-Shi 224-8540, JAPAN
 TEL: +81-45-620-3526 Fax: +81-45-591-3726
<http://www.hirose.com>
<http://www.hirose-connectors.com>