

0.3 mm Pitch, 1.0 mm above the board Flexible Printed Circuit ZIF Connectors

FH36 Series

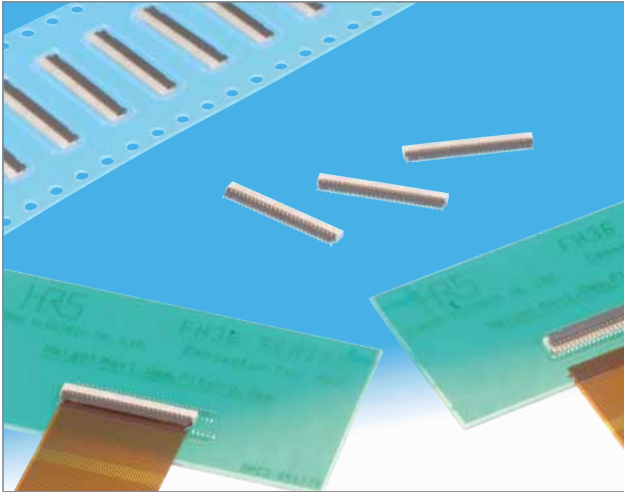

■ Features

1. Low-profile and light weight

Weight: Reduced approximately 30%
Board footprint: Reduced approximately 15%
(As compared with Hirose Electric's FH26 Series connectors (51 positions))

2. Easy solderability on the PC board

The soldering leads are on 0.6 mm pitch, exiting on front and back of the connector.

3. Conductive traces on the PCB can run under the connector

No exposed contacts on the bottom of the connector.

4. Easy FPC insertion and reliable electrical connection

Proven Flip Lock actuator allows easy insertion of FPC and provides a tactile sensation when fully closed, confirming complete electrical and mechanical connection.

5. FPC position hold

Tabs on each side of the FPC assure correct placement and hold in the connector prior to closing of the actuator.

6. Accepts standard FPC thickness

0.2mm thick standard Flexible Printed Circuit (FPC) can be used. This is the only ultra-low profile ZIF connector using standard FPC.

7. Board placement with automatic equipment

Flat upper surface and tape and reel packaging facilitate vacuum pick-up and placement. Standard reel packaging contains 5,000 connectors.

8. Halogen-free * (FH36W Series)

*As defined by IEC61249-2-21
Br-900ppm maximum, Cl-900ppm maximum,
Cl + Br combined-1,500ppm maximum

●Space saving (51 positions shown)

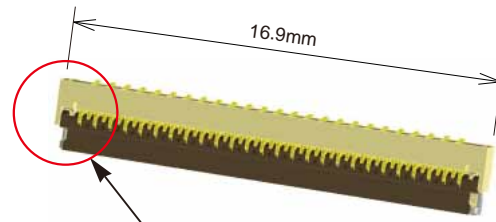
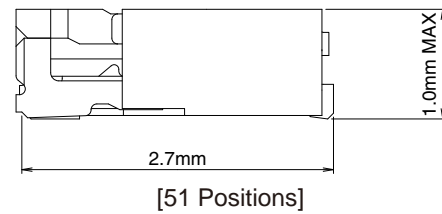

●Can be mounted over conductive traces

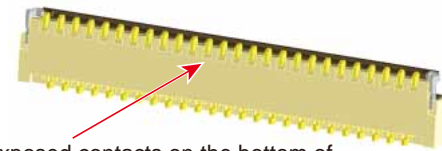

No exposed contacts on the bottom of the connector

●Operation

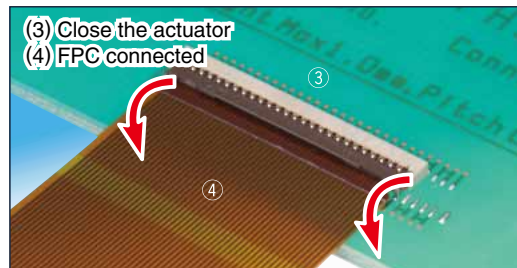
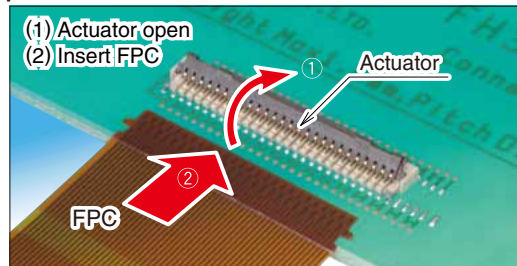

●FPC temporary hold

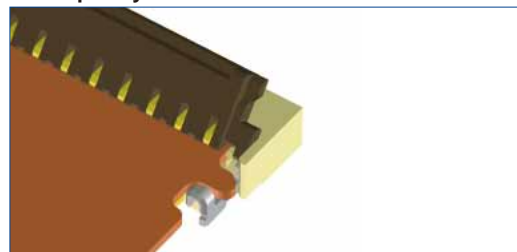

Specifications

Rating	Current rating	0.2 A DC (Note 1)	Operating temperature range	-55 to +85°C (Note 2)	Storage temperature range	-10 to +50°C (Note 3)
	Voltage rating	30 Vrms AC	Operating humidity range	Relative humidity 90% max. (No condensation)	Storage humidity range	Relative humidity 90% max. (No condensation)

Recommended FPC	Thickness: 0.2±0.03mm Gold plated
-----------------	-----------------------------------

Item	Specification	Conditions
1. Insulation resistance	50 MΩ min	100 V DC
2. Withstanding voltage	No flashover or insulation breakdown	90 Vrms AC / one minute
3. Contact resistance	100 mΩ max. * Including FPC conductor resistance	1 mA
4. Durability	Contact resistance: 100 mΩ max. No damage, cracks, or parts dislocation	10 cycles
5. Vibration	No electrical discontinuity of 1 μs or longer Contact resistance: 100 mΩ max. No damage, cracks, or parts dislocation	Frequency: 10 to 55 Hz, single amplitude of 0.75 mm 10 cycles in each of the 3 directions
6. Shock	No electrical discontinuity of 1 μs or longer Contact resistance: 100 mΩ max. No damage, cracks, or parts dislocation	Acceleration of 981m/s ² , 6 ms duration, sine half-wave, 3 cycles in each of the 3 axis
7. Humidity (Steady state)	Contact resistance: 100 mΩ max. Insulation resistance: 50 MΩ min. No damage, cracks, or parts dislocation	96 hours at a temperature of 40°C and humidity of 90 to 95%
8. Temperature cycle	Contact resistance: 100 mΩ max. Insulation resistance: 50 MΩ min. No damage, cracks, or parts dislocation	Temperature: -55°C → +15°C to +35°C → +85°C → +15°C to +35°C Time: 30 → 2 to 3 → 30 → 2 to 3 minutes 5 cycles
9. Resistance to soldering heat	No deformation of components affection performance.	1) Reflow: At the recommended temperature profile. 2) Manual soldering: 350°C ± 10°C for 5 seconds

Note 1: When passing the current through all of the contacts, use 70% of the rated current.

Note 2: Includes temperature rise caused by current flow.

Note 3: The term "storage" refers to products stored for a long period prior to mounting and use.

The operating temperature and humidity range covers the non-conducting condition of installed connectors in storage, shipment or during transportation.

Materials

Part	Material	Finish	Remarks
Insulator	LCP	Color: Beige	UL94V-0
Actuator	PA	FH36 series: Dark brown	UL94HB
		FH36W series: Light brown	UL94HB
Contacts	Phosphor bronze	Gold plating	———
Metal fittings		Pure tin reflow plating	———

Ordering information

FH 36 W - 51S - 0.3 SHW (50)

① ② ③ ④ ⑤ ⑥ ⑦

① Series name : FH	④ Number of positions : 11 to 61
② Series No. : 36	⑤ Contact pitch : 0.3mm
③ Blank :Standard W :Halogen-free (Flame retardance UL94HB).	⑥ Termination type: SMT horizontal staggered mounting type ⑦ specifications (50)...Gold plating with nickel barrier 5,000 pieces/reel (99)...Gold plating with nickel barrier 500 pieces/reel

Connector Dimensions

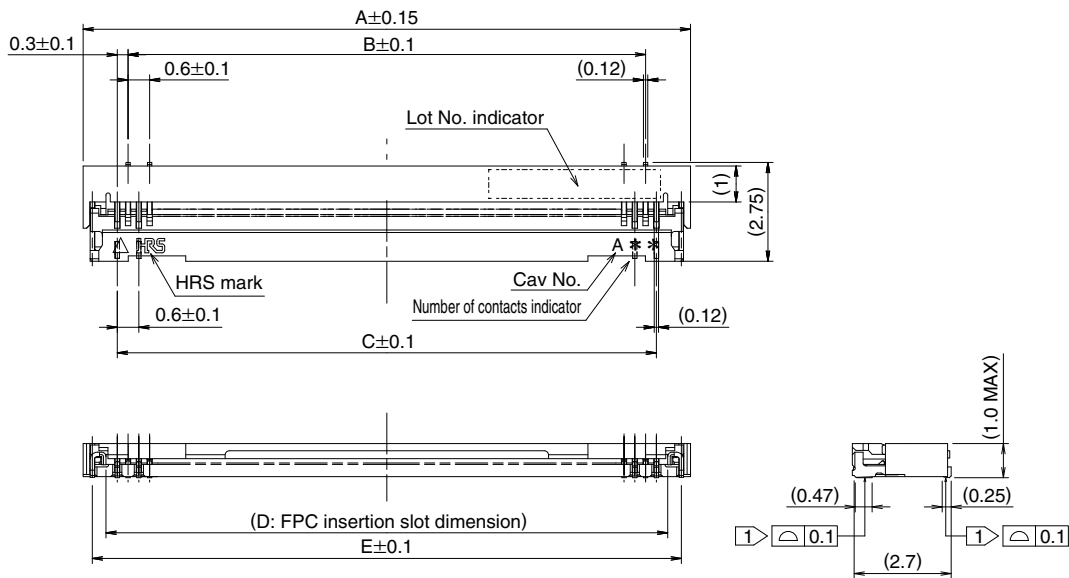

Note 1: The coplanarity of each terminal lead is within 0.1.

Note 2 : Packaged on tape and reel only. Check packaging specification.

Note 3 : Slight discoloration in color of the plastic compounds does not affect form, fit or function of the connector.

Note 4 : After reflow, the terminal plating may change color, however this does not represent a quality issue.

All dimensions: mm

Part Number	CL No.	Number of contacts	A	B	C	D	E
FH36-15S-0.3SHW(50)	580-1618-8-50	15	6.1	3.6	4.2	4.83	5.59
FH36-17S-0.3SHW(50)	580-1606-9-50	17	6.7	4.2	4.8	5.43	6.19
FH36-19S-0.3SHW(50)	580-1607-1-50	19	7.3	4.8	5.4	6.03	6.79
FH36-25S-0.3SHW(50)	580-1619-0-50	25	9.1	6.6	7.2	7.83	8.59
FH36-29S-0.3SHW(50)	580-1613-4-50	29	10.3	7.8	8.4	9.03	9.79
FH36-33S-0.3SHW(50)	580-1615-0-50	33	11.5	9	9.6	10.23	10.99
FH36-35S-0.3SHW(50)	580-1604-3-50	35	12.1	9.6	10.2	10.83	11.59
FH36-45S-0.3SHW(50)	580-1617-5-50	45	15.1	12.6	13.2	13.83	14.59
FH36-51S-0.3SHW(50)	580-1601-5-50	51	16.9	14.4	15	15.63	16.39
FH36-61S-0.3SHW(50)	580-1600-2-50	61	19.9	17.4	18	18.63	19.39
FH36W-11S-0.3SHW(50)	580-1625-3-50	11	4.9	2.4	3	3.63	4.39
FH36W-15S-0.3SHW(50)	580-1623-8-50	15	6.1	3.6	4.2	4.83	5.59
FH36W-17S-0.3SHW(50)	580-1616-2-50	17	6.7	4.2	4.8	5.43	6.19
FH36W-19S-0.3SHW(50)	580-1612-1-50	19	7.3	4.8	5.4	6.03	6.79
FH36W-23S-0.3SHW(50)	580-1614-7-50	23	8.5	6	6.6	7.23	7.99
FH36W-27S-0.3SHW(50)	580-1608-4-50	27	9.7	7.2	7.8	8.43	9.19
FH36W-31S-0.3SHW(50)	580-1609-7-50	31	10.9	8.4	9	9.63	10.39
FH36W-33S-0.3SHW(50)	580-1622-5-50	33	11.5	9	9.6	10.23	10.99
FH36W-39S-0.3SHW(50)	580-1620-0-50	39	13.3	10.8	11.4	12.03	12.79
FH36W-51S-0.3SHW(50)	580-1605-6-50	51	16.9	14.4	15	15.63	16.39
FH36W-61S-0.3SHW(50)	580-1611-9-50	61	19.9	17.4	18	18.63	19.39

Tape and reel packaging (5,000 pieces/reel, 500 pieces/reel).
Order by number of reels.

Recommended PCB mounting pattern and metal mask dimensions

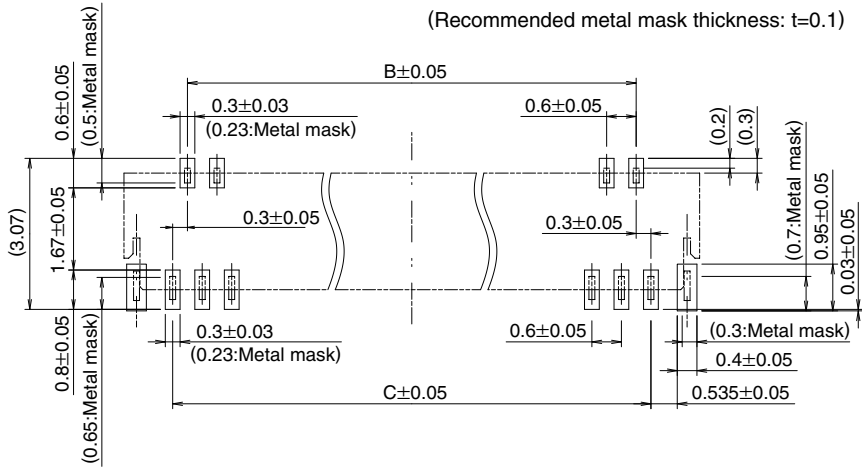

Recommended FPC Dimensions

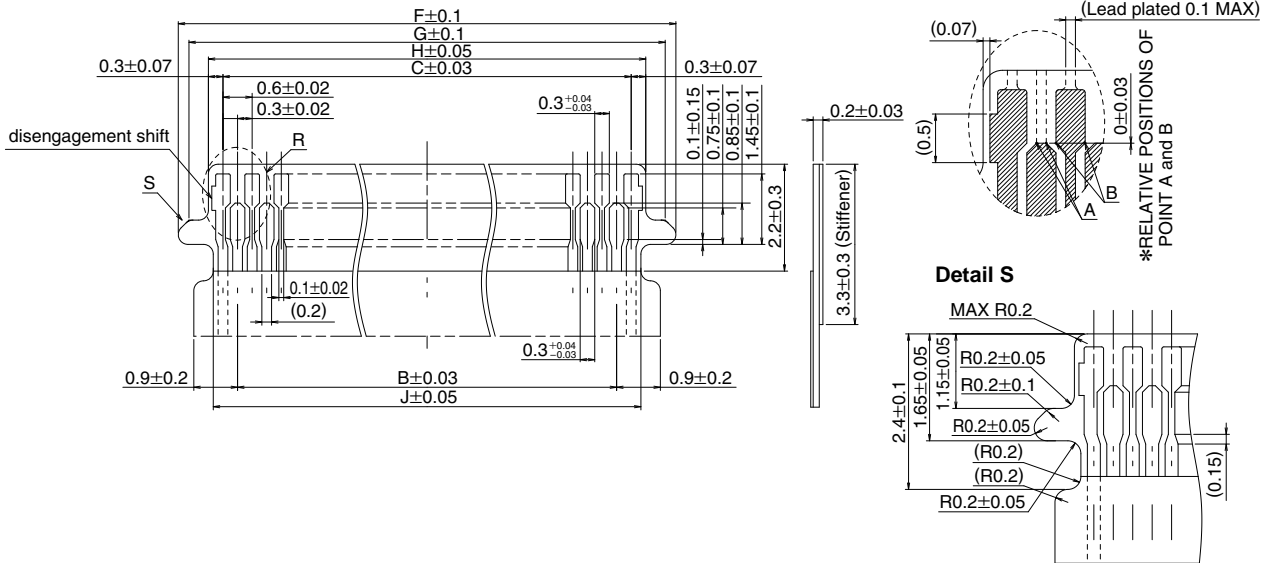

All dimensions: mm

Part Number	CL No.	Number of contacts	B	C	F	G	H	J
FH36-15S-0.3SHW(50)	580-1618-8-50	15	3.6	4.2	6.04	5.6	4.8	4.6
FH36-17S-0.3SHW(50)	580-1606-9-50	17	4.2	4.8	6.64	6.2	5.4	5.2
FH36-19S-0.3SHW(50)	580-1607-1-50	19	4.8	5.4	7.24	6.8	6	5.8
FH36-25S-0.3SHW(50)	580-1619-0-50	25	6.6	7.2	9.04	8.6	7.8	7.6
FH36-29S-0.3SHW(50)	580-1613-4-50	29	7.8	8.4	10.24	9.8	9	8.8
FH36-33S-0.3SHW(50)	580-1615-0-50	33	9	9.6	11.44	11	10.2	10
FH36-35S-0.3SHW(50)	580-1604-3-50	35	9.6	10.2	12.04	11.6	10.8	10.6
FH36-45S-0.3SHW(50)	580-1617-5-50	45	12.6	13.2	15.04	14.6	13.8	13.6
FH36-51S-0.3SHW(50)	580-1601-5-50	51	14.4	15	16.84	16.4	15.6	15.4
FH36-61S-0.3SHW(50)	580-1600-2-50	61	17.4	18	19.84	19.4	18.6	18.4
FH36W-11S-0.3SHW(50)	580-1625-3-50	11	2.4	3	4.84	4.4	3.6	3.4
FH36W-15S-0.3SHW(50)	580-1623-8-50	15	3.6	4.2	6.04	5.6	4.8	4.6
FH36W-17S-0.3SHW(50)	580-1616-2-50	17	4.2	4.8	6.64	6.2	5.4	5.2
FH36W-19S-0.3SHW(50)	580-1612-1-50	19	4.8	5.4	7.24	6.8	6	5.8
FH36W-23S-0.3SHW(50)	580-1614-7-50	23	6	6.6	8.44	8	7.2	7
FH36W-27S-0.3SHW(50)	580-1608-4-50	27	7.2	7.8	9.64	9.2	8.4	8.2
FH36W-31S-0.3SHW(50)	580-1609-7-50	31	8.4	9	10.84	10.4	9.6	9.4
FH36W-33S-0.3SHW(50)	580-1622-5-50	33	9	9.6	11.44	11	10.2	10
FH36W-39S-0.3SHW(50)	580-1620-0-50	39	10.8	11.4	13.24	12.8	12	11.8
FH36W-51S-0.3SHW(50)	580-1605-6-50	51	14.4	15	16.84	16.4	15.6	15.4
FH36W-61S-0.3SHW(50)	580-1611-9-50	61	17.4	18	19.84	19.4	18.6	18.4

Recommended FPC construction

● Contact FPC manufacturer for specific details.

1. Using Single-sided FPC

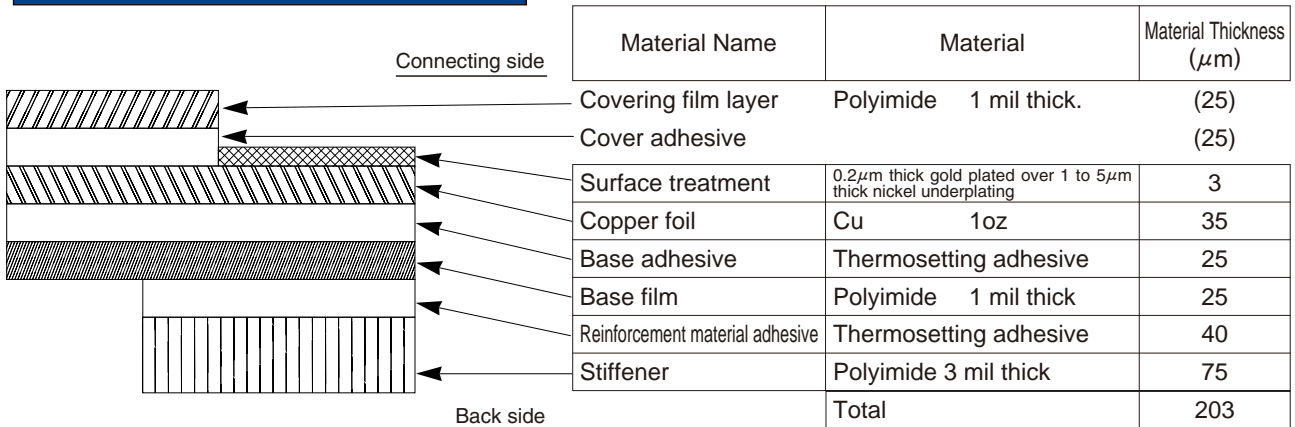

2. Using Double-sided FPC

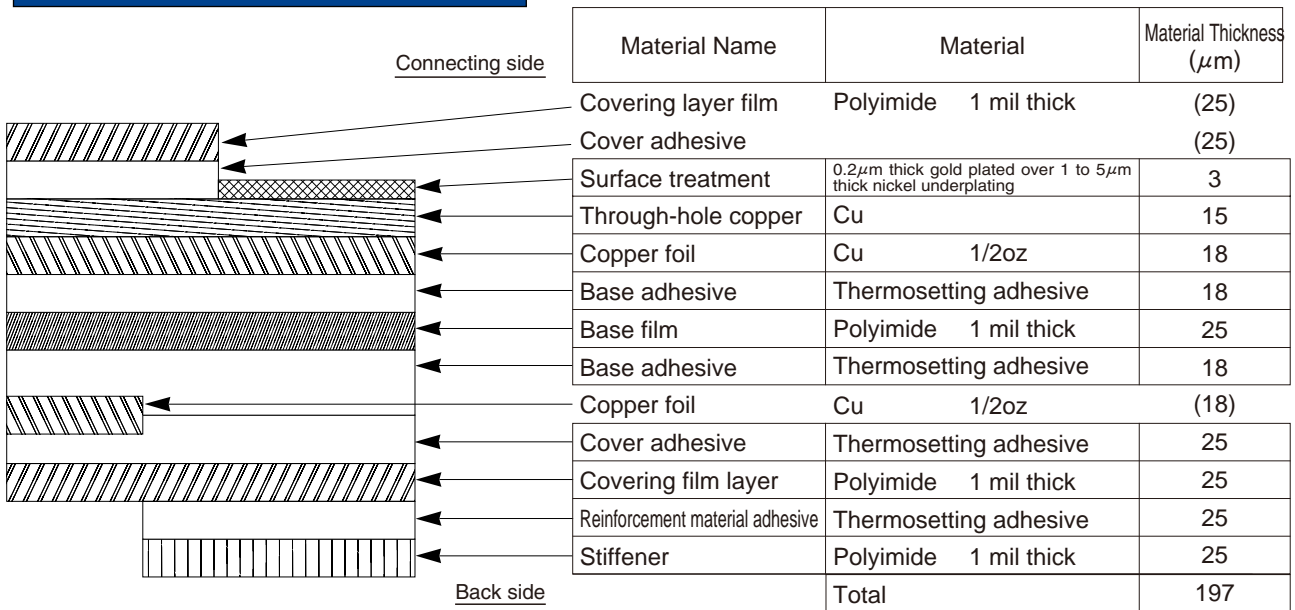

* To prevent release of the FPC due to its bending, use of the double sided FPC with copper foil on the back side is NOT RECOMMENDED.

3. Precautions

1. This specification is a recommendation for the construction of the FH36 Series FPC ($t=0.2 \pm 0.03$)
2. For details about the construction, please contact the FPC manufacturers.

■ Packaging Specification

● Embossed Carrier Tape Dimensions (Tape width of 24mm max.)

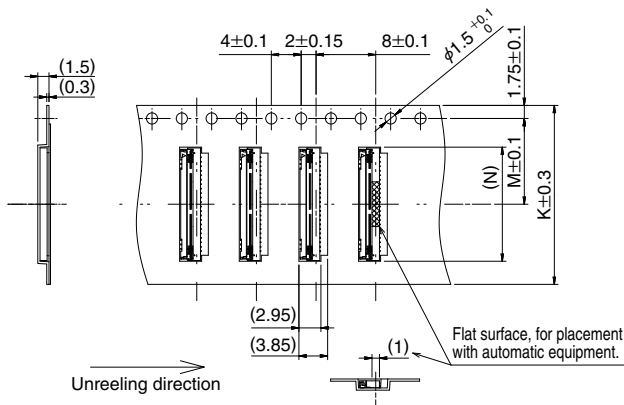

● Embossed Carrier Tape Dimensions (Tape width of 32mm min.)

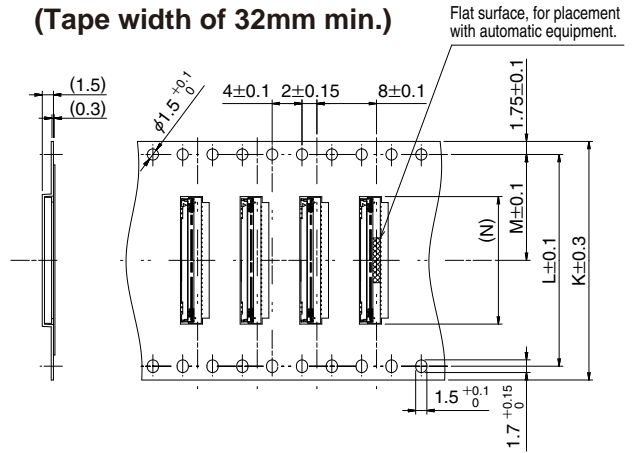

● Reel Dimensions

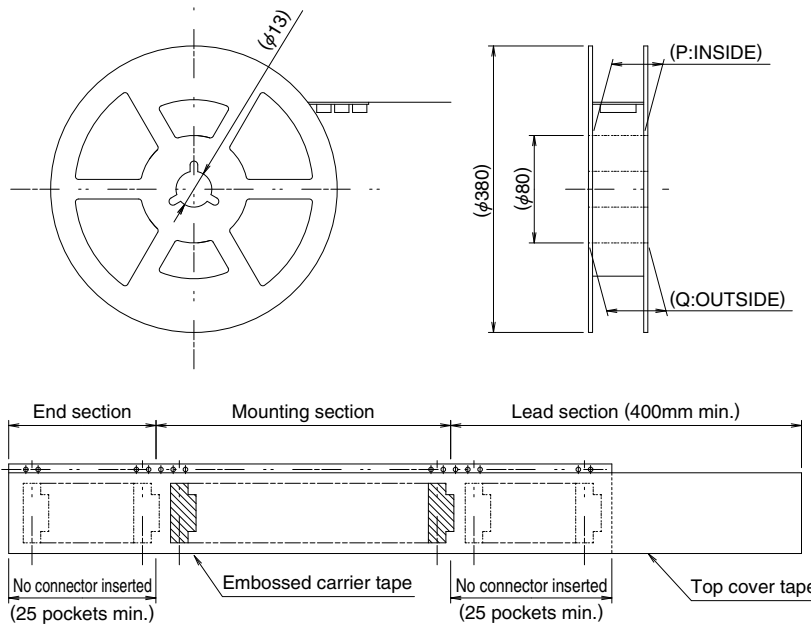

All dimensions: mm

Part Number	CL No.	Number of contacts	K	L	M	N	P	Q
FH36-15S-0.3SHW(50)	580-1618-8-50	15	16	—	7.5	6.3	17.4	21.4
FH36-17S-0.3SHW(50)	580-1606-9-50	17	16	—	7.5	6.9	17.4	21.4
FH36-19S-0.3SHW(50)	580-1607-1-50	19	16	—	7.5	7.5	17.4	21.4
FH36-25S-0.3SHW(50)	580-1619-0-50	25	24	—	11.5	9.3	25.4	29.4
FH36-29S-0.3SHW(50)	580-1613-4-50	29	24	—	11.5	10.5	25.4	29.4
FH36-33S-0.3SHW(50)	580-1615-0-50	33	24	—	11.5	11.7	25.4	29.4
FH36-35S-0.3SHW(50)	580-1604-3-50	35	24	—	11.5	12.3	25.4	29.4
FH36-45S-0.3SHW(50)	580-1617-5-50	45	24	—	11.5	15.3	25.4	29.4
FH36-51S-0.3SHW(50)	580-1601-5-50	51	32	28.4	14.2	17.1	33.4	37.4
FH36-61S-0.3SHW(50)	580-1600-2-50	61	32	28.4	14.2	20.1	33.4	37.4
FH36W-11S-0.3SHW(50)	580-1625-3-50	11	16	—	7.5	5.1	17.4	21.4
FH36W-15S-0.3SHW(50)	580-1623-8-50	15	16	—	7.5	6.3	17.4	21.4
FH36W-17S-0.3SHW(50)	580-1616-2-50	17	16	—	7.5	6.9	17.4	21.4
FH36W-19S-0.3SHW(50)	580-1612-1-50	19	16	—	7.5	7.5	17.4	21.4
FH36W-23S-0.3SHW(50)	580-1614-7-50	23	24	—	11.5	8.7	25.4	29.4
FH36W-27S-0.3SHW(50)	580-1608-4-50	27	24	—	11.5	9.9	25.4	29.4
FH36W-31S-0.3SHW(50)	580-1609-7-50	31	24	—	11.5	11.1	25.4	29.4
FH36W-33S-0.3SHW(50)	580-1622-5-50	33	24	—	11.5	11.7	25.4	29.4
FH36W-39S-0.3SHW(50)	580-1620-0-50	39	24	—	11.5	13.5	25.4	29.4
FH36W-51S-0.3SHW(50)	580-1605-6-50	51	32	28.4	14.2	17.1	33.4	37.4
FH36W-61S-0.3SHW(50)	580-1611-9-50	61	32	28.4	14.2	20.1	33.4	37.4

■ Temperature Profile

● Using Lead-free Solder Paste

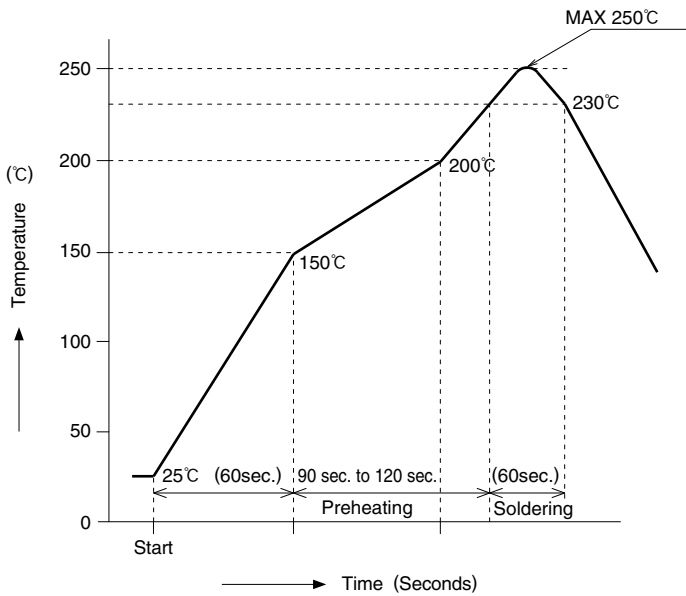

HRS test condition

Solder method	:Reflow, IR/hot air
Environment	:Room air
Solder composition	:Paste, 96.5%Sn/3.0%Ag/0.5%Cu (Senju Metal Industry, Co., Ltd.'s Part Number:M705-221CM5- 32-10.5)
Test board	:Glass epoxy 25mm×50mm×0.8mm thick
Land dimensions	:0.3mm×0.6mm, 0.3mm×0.8mm
Metal mask	:0.23×0.5, 0.23×0.65×0.1mm thick

The temperature profiles shown are based on the above conditions. In individual applications the actual temperature may vary, depending on solder paste type, volume / thickness and board size / thickness. Consult your solder paste and equipment manufacturer for specific recommendations.

■ Operation and Precautions

Operation

1. FPC insertion procedure. Connector installed on the board.

- ① Lift up the actuator.
Use thumb or index finger.

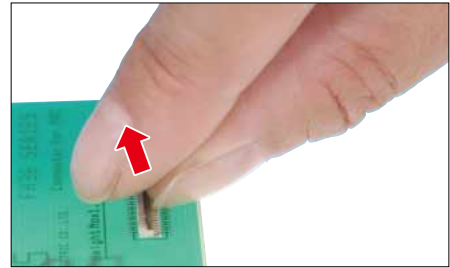

- ② Insert the FPC (contact surfaces facing down) at angle of approximately 10° to the board surface ①, making sure that the FPC positioning tabs clear the protrusions on both sides of the connector. Lower the FPC down ②, parallel to the board surface.

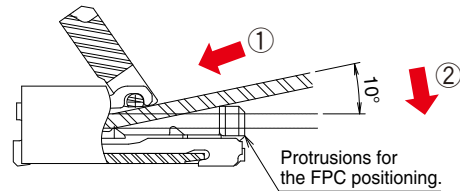
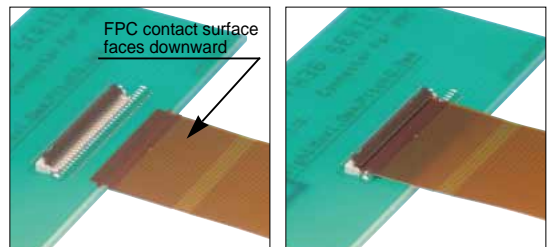

- ③ Rotate down the actuator until firmly closed.

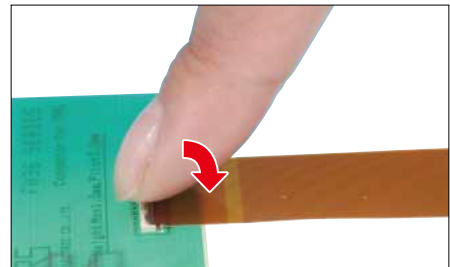

2. FPC removal

- ① Lift up the actuator
Pull up the FPC at an angle of approximately 10° ① and then withdrew it from the connector ②.

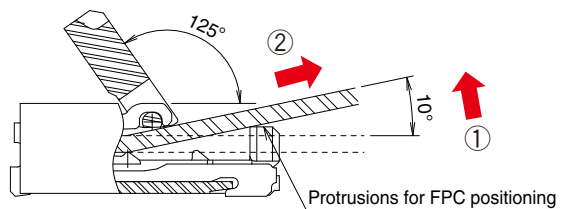
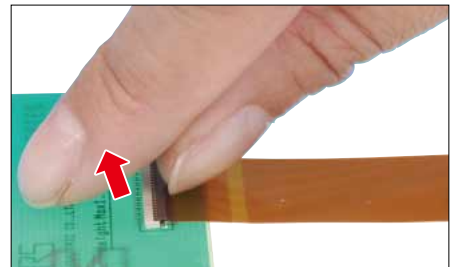

Precautions

Exercise care when handling connectors. Follow recommendations given below.

[Precautions when mounting connectors on the PCB]

◆ Handling before mounting on PCB

Insertion of the FPC or operation of the actuator prior to mounting on the PCB is NOT RECOMMENDED.

◆ PC board warpage

Minimize the warpage as much as possible. The connector is straight within 0.1 mm max. Make sure that the mounting area flatness can accept the connector terminals without causing any failure of the solder joints.

◆ When braking the large PC board into individual boards exercise care NOT to damage the installed connectors.

◆ When attaching the boards or other components with the screws make sure that any stresses will NOT cause board deflections affecting the mounting areas of the connector.

◆ Bending of the board

For a board width of 100 mm, bending of the board must be 0.5 mm max. (Ref to Fig. 1)

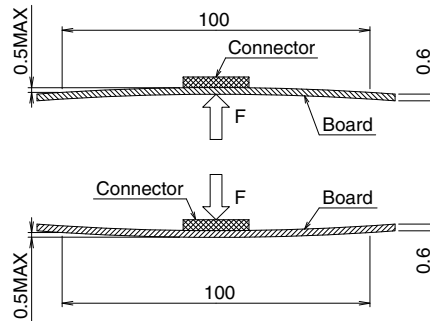

Fig. 1

[Precautions during FPC insertion and mating]

Pay attention to the following points when inserting FPC.

◆ Actuator operation

① Do not apply excessive force when opening the actuator prior to FPC insertion. When opening make sure that the force is applied only to the actuator itself, avoiding touching of the contacts.

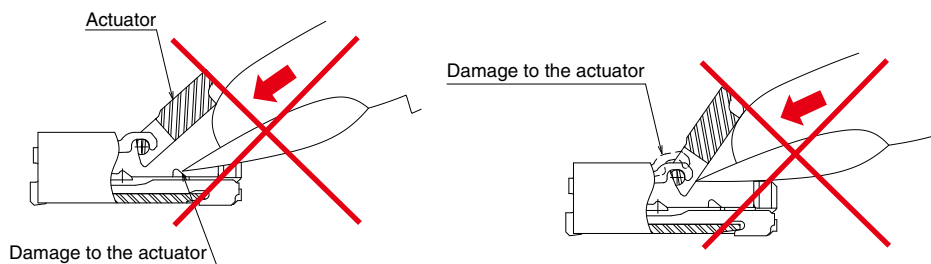

② Axis of rotation

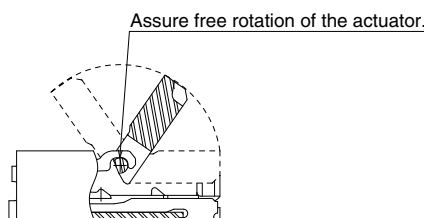

Precautions

- ③ The actuator will rotate 125°C. Do not apply force to rotate further.

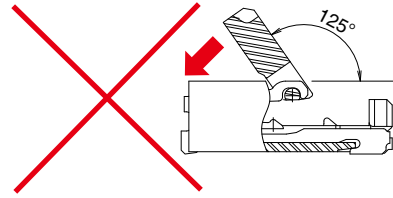

- ④ When opening or closing the actuator, do so at the center section.

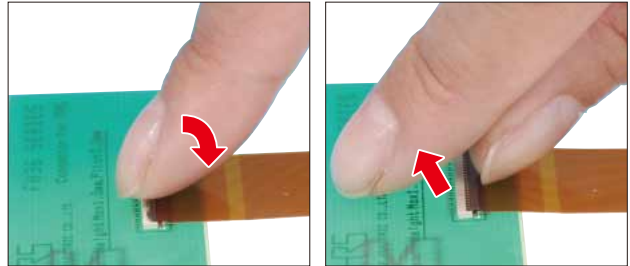

- ⑤ Do not grasp or lift the actuator (Fig. 2) nor insert the nail from the back of it (Fig. 3).

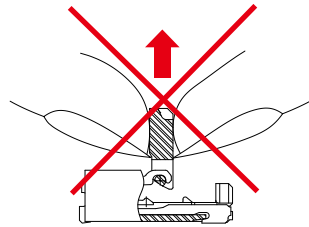

Fig. 2

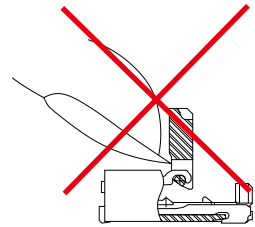
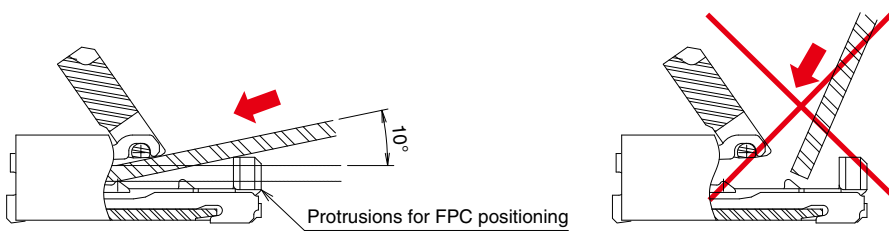

Fig. 3

◆ FPC insertion

Do not insert the FPC at any high angle from above.



Precautions

As illustrated (Fig. 4) angle insertion may cause electrical discontinuity when the FPC is deflected in use.

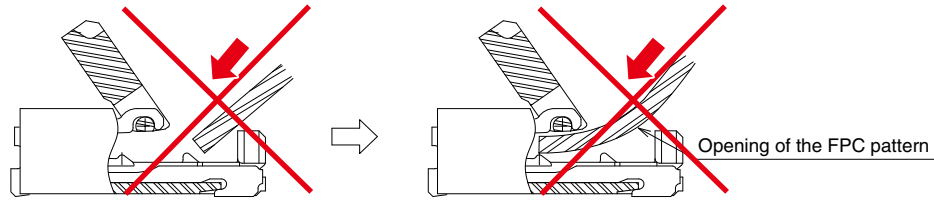

Fig. 4

- To avert insertion of the FPC at an angle, consideration should be given to securing enough insertion space when designing the board lay-out. Insertion will be difficult when the FPC is too short.
- Contact FPC manufacturer for information about the bending specifications.

◆Verification of the fully closed actuator

The FPC should be fully inserted, with its positioning tabs fully behind the protrusions on both sides of the connector's insertion slot (Fig. 5).

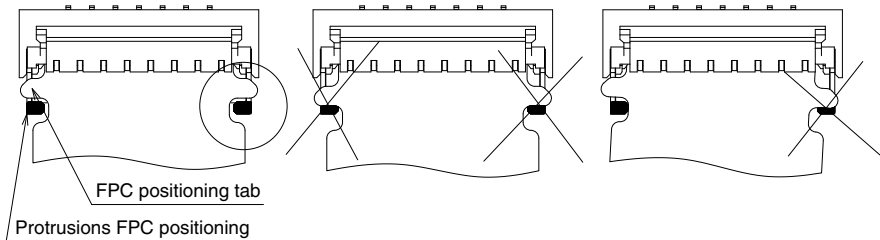

Fig. 5

[Routing of the FPC (FPC fully inserted / actuator closed)]

- ◆Do not apply any pull or upward-directed force to the FPC.
Do not make any sharp bends of FPC close to the immediate exit from the connector (Fig. 6)

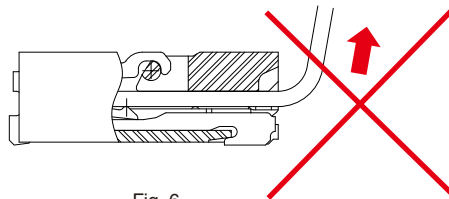
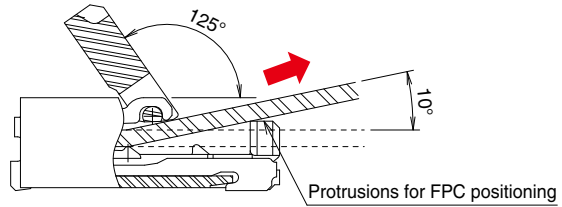
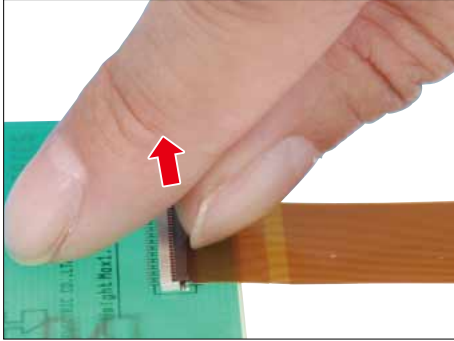

Fig. 6

Precautions

[Removing of the FPC]

- ◆ Rotate the actuator to the fully open position (max. angle of 125°)
Lift the FPC approximately 10° (making sure that the positioning tabs clear the protrusions on both sides) and carefully withdraw it from the connector.



[Other Precautions]

- ◆ Hand Soldering Precautions
When hand soldering:
 - ① Do not perform reflow or hand soldering with the FPC inserted in the connector.
 - ② Do not apply excessive heat or touch the soldering iron anywhere other than the connector leads.
 - ③ Do not use excessive amount of solder or flux compounds.
 Operation of the actuator or contacts may be affected by excessive amounts of solder or flux com-



HIROSE ELECTRIC CO.,LTD.

6-3,Nakagawa Chuoh-2-Chome,Tsuzuki-Ku,Yokohama-Shi 224-8540,JAPAN
 TEL: +81-45-620-3526 Fax: +81-45-591-3726
<http://www.hirose.com>
<http://www.hirose-connectors.com>