



*Quality Products. Service Excellence.*

## "C" Channel Mounting Kit S2CCMK Series



- For use in Turrets, Data Terminals and Bases.
- Provide adjustable (side to side) mounting support for Base Panels and all Rail Support Kits.
- Available in 4 widths.
- Finished in textured black.

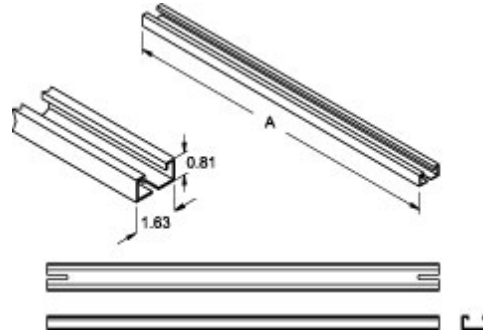

Part No.	Fits Console Width	A
2CMC24	24.00	23.50
2CMC36	36.00	33.50
2CMC48	48.00	47.50
2CMC60	60.00	59.50

*Data subject to change without notice*

© 2020. Hammond Manufacturing Ltd. All rights reserved.