



Quality Products. Service Excellence.

Isolation (115VAC to 115VAC) 169S Series

Hard Wired



Features

- Primary 115VAC, 60 Hz., Secondary 115VAC
- Electrostatic shield between primary & secondary
- Connection by flexible leads, 8" minimum length
- Perfect for circuit isolation or "Classic" bias power supply
- CSA certified (209651)

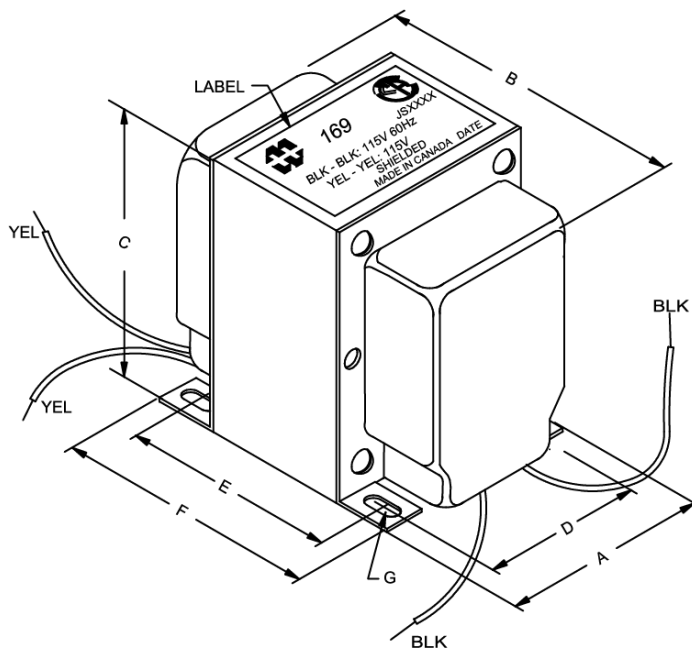

Part No.	Capacity	Secondary Current	Overall Dimensions					Weight
	VA	ma	A	B	C	D	E	Lbs
169PS	15	130	1.88	2.07	2.50	1.50	1.19	1.3
169QS	40	260	2.19	2.50	2.63	1.75	1.44	2.5
169RS	60	435	2.50	2.75	3.06	2.00	1.69	3.3
169SS	90	650	2.50	3.25	3.06	2.00	2.19	4.5
169TS	135	870	3.13	3.50	3.81	2.50	2.19	6.5
169VS	175	1300.00	3.13	4.00	3.81	2.50	2.69	7
169WS	250	1700.00	3.75	4.00	4.56	3.00	2.81	12

Data subject to change without notice

© 2020. Hammond Manufacturing Ltd. All rights reserved.

