



*Quality Products. Service Excellence.*

## Audio Open Frame 149 Series

PC Board Mount



### Features

- Pin type (0.25" length & 0.025" square), P.C. board mount.
- Economical, open type, horizontal bracket construction.
- Includes clinching lugs for extra mounting strength.
- Frequency response 200 Hz. - 15 KHz. (+/- 1 db, ref. @ 1 KHz.).
- Total distortion approximately 2% for drivers and 1% for outputs at 200 Hz., decreasing at higher frequencies.
- Insertion loss less than 1/2 db.
- Bifilar wound for balanced capacitive and resistance characteristics, on pin bobbins for standard 0.2" grid pin spacing.
- Insulation test 250V rms.
- For rugged epoxy cast type units refer to our **102, 104, 106** or **107, 108** and **109** series.
- Net weight: 0.6 oz. (148 Series) & 1.0 oz. (149 Series).

**149 Series Schematics (See Table Below)**

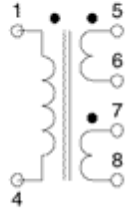
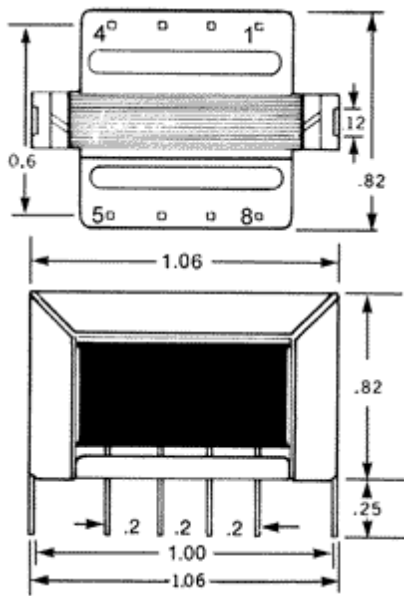

Fig. 2

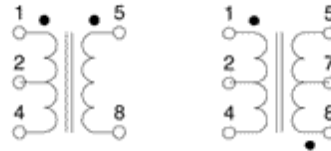

Fig. 4

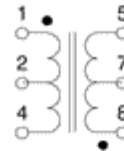

Fig. 5

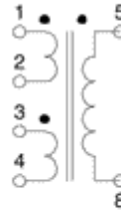

Fig. 6



Fig. 7

Part No.	Applicaton	Nominal Impedance (Ohms)		Max. Primary D.C. current (ma.) (See Note 1)	D.C. Resistance (Ohms) +/- 15% (See Note 2)		Output (Milliwatts)	Schematic Drawing Figure
		Primary	Secondary		Primary	Secondary		
149C	Driver	160	20/80	56	24	7	200	2
149E	Driver	300	30/120	42	41	10	200	2
149F	Driver	450	40/160	33	52	19	200	2
149G	Driver	600	150/600	29	92	58	200	2
149H	Driver	1000	60/240	22	155	24	200	2
149Q	Output	200 ct	3.2	7	19	0.4	1000	4
149S	Output	600 ct	150 ct	4	53	17	1000	5
149T	Output	600 ct	600 ct	4	53	70	1000	5
149U	Output	150/600	8	4	53	95	1000	6
149V	Hybrid	600 ct	300/1200	4	53	63	1000	7

Data subject to change without notice

© 2020. Hammond Manufacturing Ltd. All rights reserved.