

LB201S thru LB2010S

Low Profile Miniature Single Phase Surface Mount Bridge Rectifiers
 Reverse Voltage 100~1000V Output Current 2.0A

Features

- Glass passivated standard bridge rectifiers
- Moisture sensitivity: Level 1, per J-STD-020
- Solder dip 260°C, 10s
- Plastic package has Underwriters Laboratory Flammability Classification 94V-0
- Add suffix "E" for Halogen Free
- Halogen-free according to IEC 61249-2-21 definition

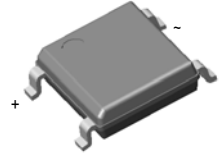

Package: ABF

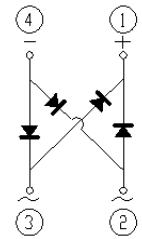

Schematic Diagram

Applications

For use of general purpose AC-DC bridge rectification in power supply, charger and telecom device applications.

Absolute Maximum Ratings ($T_A=25^\circ\text{C}$ unless otherwise noted)

Parameter	Symbol	LB201S	LB202S	LB204S	LB206S	LB208S	LB2010S	Unit
Maximum Repetitive Peak Reverse Voltage	V_{RRM}	100	200	400	600	800	1000	V
Maximum RMS Voltage	V_{RMS}	70	140	280	420	560	700	V
Maximum DC Blocking Voltage	V_{DC}	100	200	400	600	800	1000	V
Maximum Average Output Rectified Current	$I_{O(AV)}$	2.0						A
Peak Forward Surge Current (8.3 ms single half sine-wave superimposed on rated load)	I_{FSM}	60						A
Rating for Fusing ($t < 8.3\text{ms}$)	I^2t	15						A^2sec
Operating Junction and Storage Temperature Range	T_J, T_{STG}	- 55 to + 150						$^\circ\text{C}$

Electrical Characteristics ($T_A=25^\circ\text{C}$ unless otherwise noted)

Parameter	Test Conditions	Symbol	LB201S	LB202S	LB204S	LB206S	LB208S	LB2010S	Unit
Maximum Instantaneous Forward Voltage	$I_F=2.0\text{A}$	V_F	1.1						V
Maximum DC Reverse Current at Rated DC Blocking Voltage	$T_A=25^\circ\text{C}$	I_R	5.0						μA
	$T_A=125^\circ\text{C}$		100						
Typical Junction Capacitance	4.0 V, 1 MHz	C_J	10						pF

Thermal Characteristics

Parameter	Symbol	LB201S	LB202S	LB204S	LB206S	LB208S	LB2010S	Unit
Typical Thermal Resistance ⁽¹⁾	$R_{\theta JA}$	80						$^\circ\text{C/W}$
	$R_{\theta JL}$	25						

Notes: 1. Mounted on FR-4 P.C.B Board

Typical Electrical Characteristic Curves

Fig.1 Forward Current Derating Curve

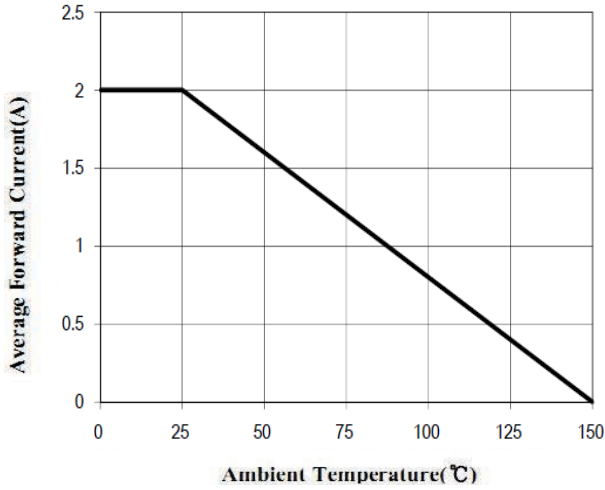

Fig.2 Maximum Non-Repetitive Peak Forward Surge Current

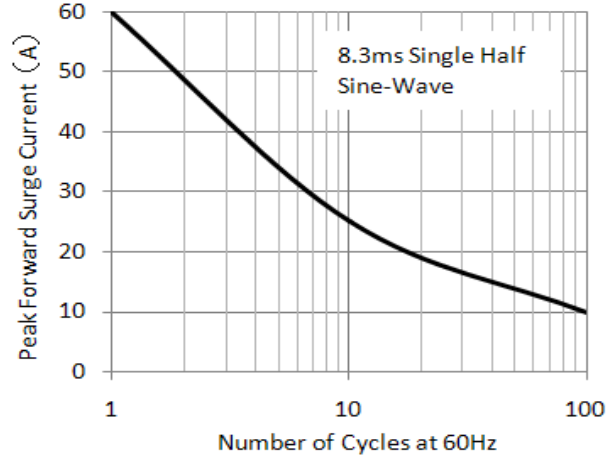

Fig.3 Typical Instantaneous Forward Characteristics

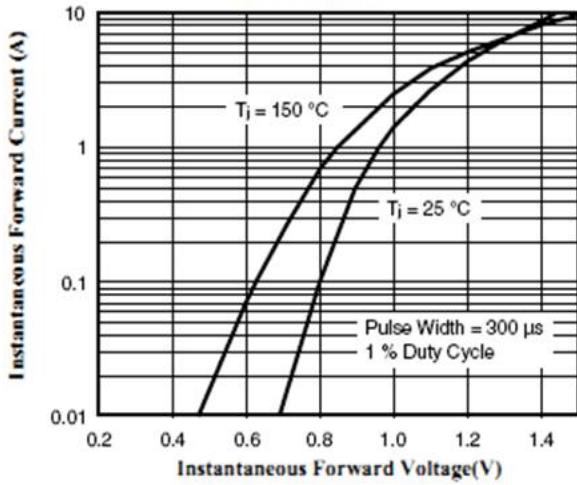

Fig.4 Forward Power Dissipation

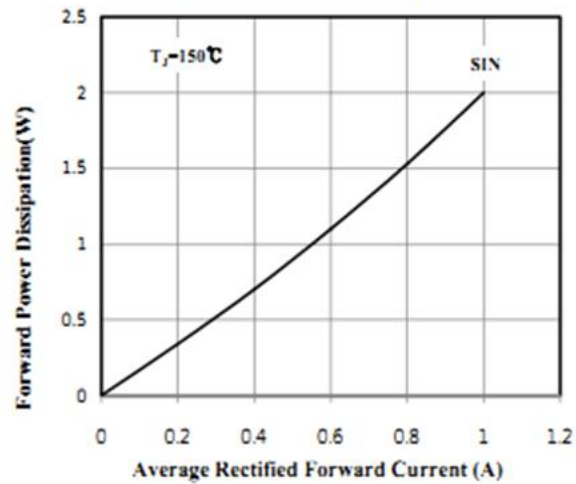
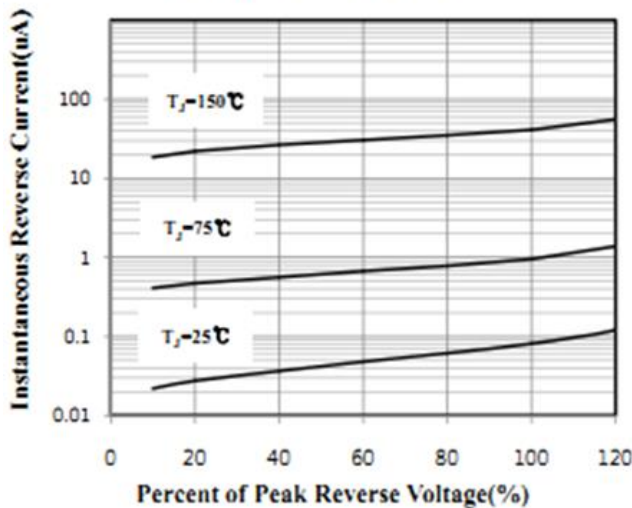

Fig.5 Typical Reverse Characteristics



LB201S thru LB2010S

Low Profile Miniature Single Phase Surface Mount Bridge Rectifiers
 Reverse Voltage 100~1000V Output Current 2.0A

Package Outline Dimensions

ABF

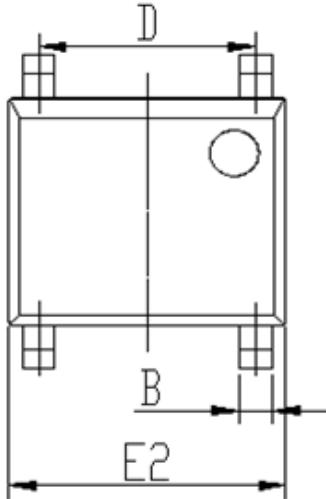

DIM	Unit: mm		Unit: inch	
	MIN	MAX	MIN	MAX
A	1.25	1.35	0.049	0.053
A1	0.00	0.15	0.000	0.006
B	0.50	0.70	0.020	0.028
C	0.15	0.30	0.006	0.012
D	3.80	4.20	0.150	0.165
E1	4.40	4.60	0.173	0.181
E2	5.00	5.20	0.197	0.205
L	0.25	0.65	0.010	0.026
HE	6.00	6.40	0.236	0.252
H	1.20	1.30	0.047	0.051

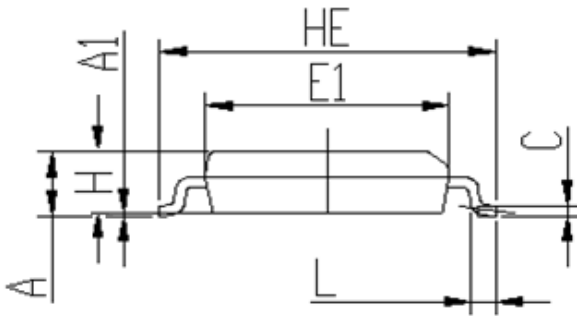

Taping Orientation

