



FSP Fortron/Source

## SPI-250G (EOL)

[bulk.fsp-europe.com/spi-250g](http://bulk.fsp-europe.com/spi-250g)

This AT form factor PSU has a real power rating of 250W (continuous). The 8cm fan located on the back of the PSU ensures that it can be used in any kind of ATX chassis without any compatibility issues.

A unique feature of the SPI-250G is its monitor outlet that allows an external display to be powered directly from the desktop PC (provided that the external display has a C14 AC power inlet). It also has a -5V rail that allows the use of industrial and legacy motherboards.

### Features:

- -5V rail available
- OVP / OCP / SCP protection
- 8cm fan on the rear side
- Monitor Outlet
- AT form factor
- AT legacy connectors



### Specifications:

Output Table

AC Input	180~264V, 3A, 47~53Hz				
DC Output	+3.3V	+5V	+12V	-12V	-5V
Max Output Current	-	26A	9A	0.5A	0.5A
Max Combined Power	130W		108W	8.5W	
Total Power	250W				
Peak Power					



Dimension	Depth	Width	Height
(mm)	140	150	85.7



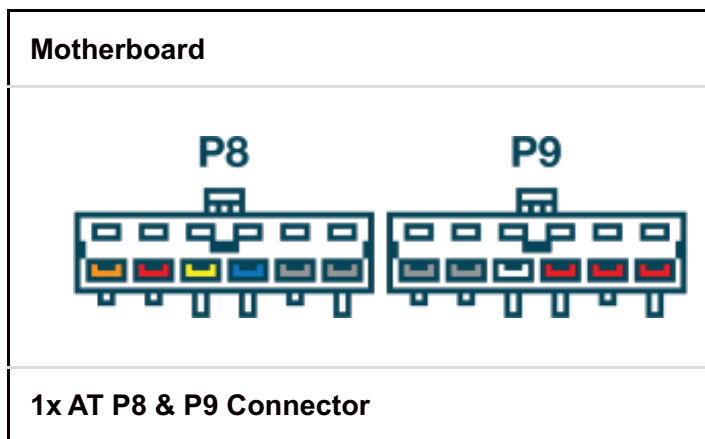

PSU Load	20%	50%	100%
Efficiency	65%	65%	65%

### Connectors:



CPU 8 Pin	CPU 4+4 Pin	CPU 4 Pin
-----------	-------------	-----------

Graphics	
	
PCI-E 2.0 6+2 (8) Pin	PCI-E 2.0 6 Pin

Peripherals			
			
S-ATA	3x Molex 4 Pin	1x Floppy 4 Pin	Fan 2 Pin