

# 2.7" (Color) Front Light Panel



12380-xx | Product Data Sheet | 2018

For more information:

WEB [flexlighting.com](http://flexlighting.com)

CONTACT [flexlighting.com/contact](http://flexlighting.com/contact)

PHONE 773-295-0305

## Overview

The **FLEX Front Light Panel** optical film is designed to laminate to the front surface of **JDI reflective display (LPM027M128B)** to provide high quality on-demand display lighting. This thin plastic panel incorporates only a single LED which enables product designers to develop ultra-thin devices and minimize battery use.

- One **low-power** LED (included in Front Light)
- Over **80x less power** compared to traditional backlighting
- 0.05 mm thick FLEX film is over **5x thinner** than alternative lightguides

## Mechanical

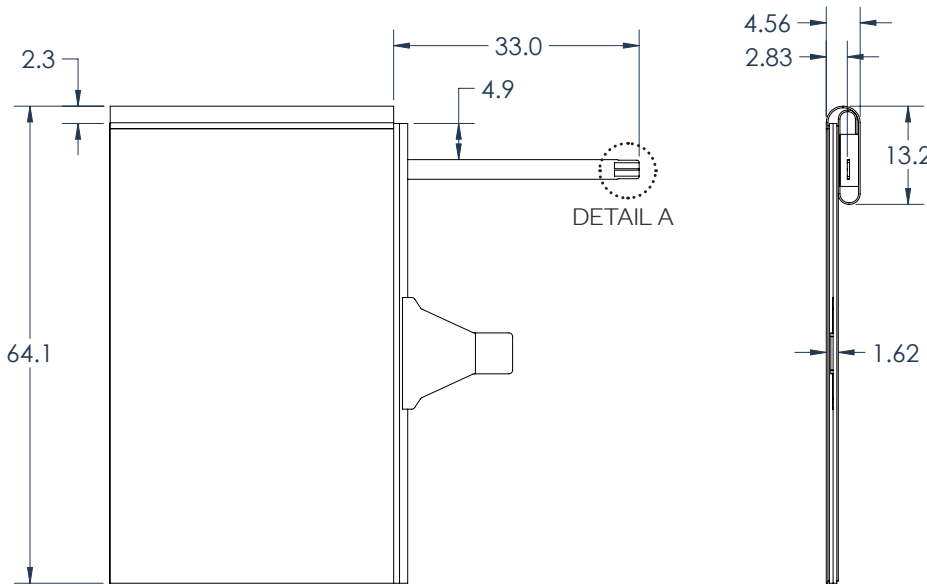

All dimensions in mm

Flexible film allows for different placement options for the light source (examples below)

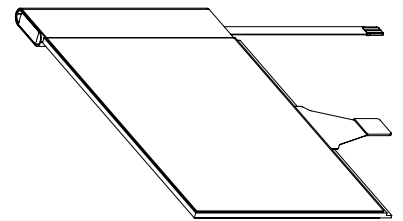

12380-01

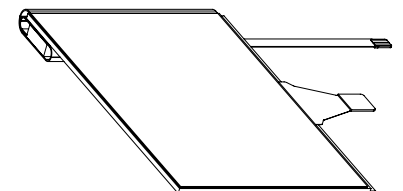

12380-03

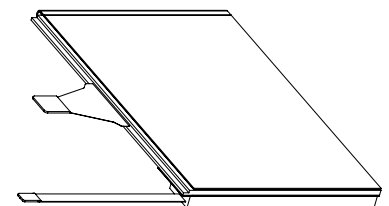

12380-06  
PRELIMINARY



12380-03  
UNDER DISPLAY

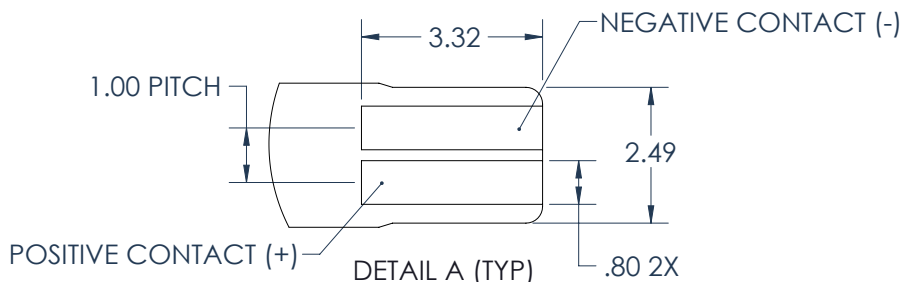

# 2.7" (Color) Front Light Panel



12380-xx | Product Data Sheet | 2018

For more information:

WEB [flexlighting.com](http://flexlighting.com)

CONTACT [flexlighting.com/contact](http://flexlighting.com/contact)

PHONE 773-295-0305

## Electrical

Item	Symbol	Typical	Absolute Max	Unit
Forward Current	$I_F$	5	25	mA
Pulse Forward Current	$I_{FP}$	--	80	mA
Reverse Voltage	$V_R$	--	5	V

### Example ZIF Connectors:

- Molex 503480-0400
- Molex 52745-0497
- Molex 54550-0471
- Molex 54548-0471 (bottom)
- Molex 505110-0492

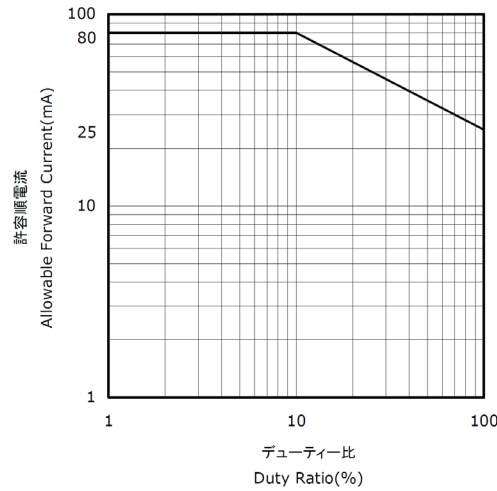
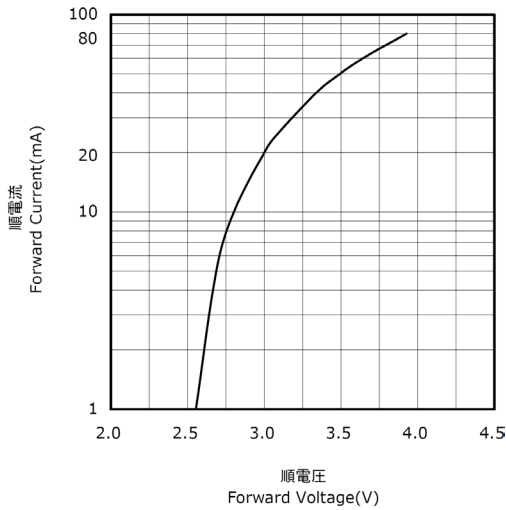

## Optical

2.7" JDI + Front Light (12380-01)					
Item	Symbol	TYP.	Unit	Remark	
Viewing Angle CR > 2	V	$\Theta 11$ $\Theta 12$	65 65	° (Degree)	[Remark 1]
	H	$\Theta 21$ $\Theta 22$	30 40	° (Degree)	
Contrast Ratio	Front light ON	CR	14	--	[Remark 2]

### Brightness vs. Power

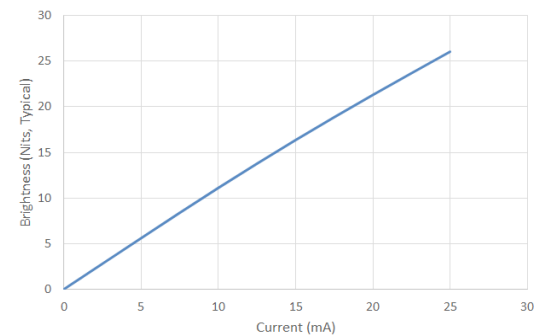

Remark 1: Viewing Angle

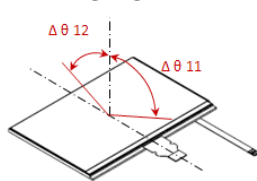

Remark 2: Definition of Contrast Ratio

$$\text{Contrast Ratio (CR)} = \frac{\text{Reflection intensity in white display}}{\text{Reflection intensity in black display}}$$

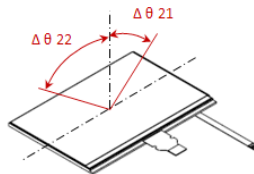

Measurements taken with a Minolta Chroma Meter CS-100 at a 17" view distance