

Features

- 1 & 2 Pole - Low profile (15.7 mm height)
- 41.31 - 1 Pole 12 A (3.5 mm pin pitch)
- 41.52 - 2 Pole 8 A (5 mm pin pitch)
- 41.61 - 1 Pole 16 A (5 mm pin pitch)

PCB mount

- direct or via PCB socket
- 35 mm rail mount
- via screw and screwless sockets

- DC coils - 400 mW
- 8 mm, 6 kV (1.2/50 μ s) isolation, coil-contacts
- Cadmium Free contact materials
- Flux proof: RT II standard, (RT III option)

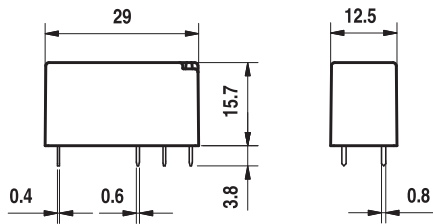

FOR UL RATINGS SEE:
"General technical information" page V

41.31



- 3.5 mm contact pin pitch
- 1 Pole 12 A
- PCB direct or via socket

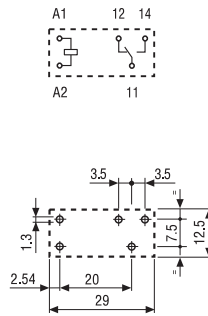

Copper side view

41.52



- 5 mm contact pin pitch
- 2 Pole 8 A
- PCB direct or via socket

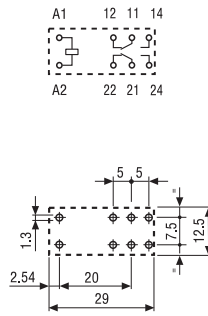

Copper side view

41.61



- 5 mm contact pin pitch
- 1 Pole 16 A
- PCB direct or via socket

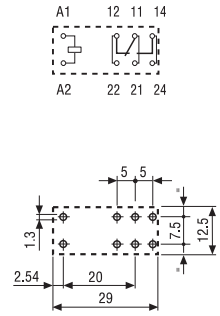

Copper side view

| Contact specification | | | | |
|---|-----------------|--------------------------------------|---------------------------|---------------------------|
| Contact configuration | | 1 CO (SPDT) | 2 CO (DPDT) | 1 CO (SPDT) |
| Rated current/Maximum peak current | A | 12/25 | 8/15 | 16/30 |
| Rated voltage/Maximum switching voltage | V AC | 250/400 | 250/400 | 250/400 |
| Rated load AC1 | VA | 3,000 | 2,000 | 4,000 |
| Rated load AC15 (230 V AC) | VA | 600 | 400 | 750 |
| Single phase motor rating (230 V AC) | kW | 0.5 | 0.3 | 0.5 |
| Breaking capacity DC1: 30/110/220 V | A | 12/0.3/0.12 | 8/0.3/0.12 | 16/0.3/0.12 |
| Minimum switching load | mW (V/mA) | 300 (5/5) | 300 (5/5) | 300 (5/5) |
| Standard contact material | | AgNi | AgNi | AgNi |
| Coil specification | | | | |
| Nominal voltage (U _N) | V AC (50/60 Hz) | — | — | — |
| | V DC | 12 - 24 - 48 - 60 - 110 | 12 - 24 - 48 - 60 - 110 | 12 - 24 - 48 - 60 - 110 |
| Rated power AC/DC | VA (50 Hz)/W | —/0.4 | —/0.4 | —/0.4 |
| Operating range | AC | — | — | — |
| | DC | (0.7...1.5)U _N | (0.7...1.5)U _N | (0.7...1.5)U _N |
| Holding voltage | AC/DC | —/0.4U _N | —/0.4 U _N | —/0.4 U _N |
| Must drop-out voltage | AC/DC | —/0.1U _N | —/0.1 U _N | —/0.1 U _N |
| Technical data | | | | |
| Mechanical life AC/DC | cycles | —/30·10 ⁶ | —/30·10 ⁶ | —/30·10 ⁶ |
| Electrical life at rated load AC1 | cycles | 150 · 10 ³ | 80 · 10 ³ | 70 · 10 ³ |
| Operate/release time | ms | 5/4 | 5/4 | 5/4 |
| Insulation between coil and contacts (1.2/50 μ s) | kV | 6 (8 mm) | 6 (8 mm) | 6 (8 mm) |
| Dielectric strength between open contacts | V AC | 1,000 | 1,000 | 1,000 |
| Ambient temperature range | °C | −40...+85 | −40...+85 | −40...+85 |
| Environmental protection | | RT II | RT II | RT II |
| Approvals (according to type) | | RINA UL US DVE | | |

Features

Solid State Relays

Printed circuit mount:

- direct or via PCB socket

35 mm rail mount:

- via screw or screwless sockets

- Single circuit output switching options
- 5 A 24 V DC
- 3 A 240 V AC
- Silent, high speed switching with long electrical life
- LED indicator
- Low profile (15.7 mm)
- Wash tight: RT III
- 2,500 V AC insulation, input-output

41.81 - 9024



- 5 A, 24 V DC output switching
- PCB or 93 Series sockets

41.81 - 8240



- 3 A, 240 V AC output switching
- Zero crossing switching
- PCB or 93 Series sockets

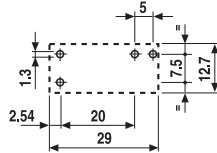
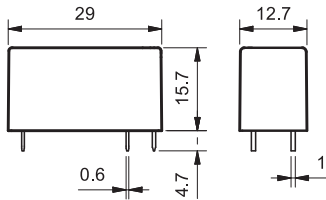
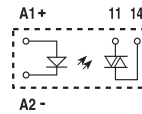
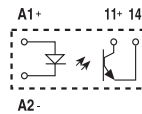

Copper side view

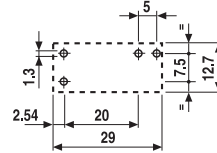

Copper side view

| Output circuit | | | | | |
|---|--|----------------|---------|----------------|---------|
| Contact configuration | | 1 NO (SPST-NO) | | 1 NO (SPST-NO) | |
| Rated current/Maximum peak current (10 ms) A | | 5/40 | | 3/40 | |
| Rated voltage/Maximum blocking voltage V | | (24/35)DC | | (240/275)AC | |
| Switching voltage range V | | (1.5...24)DC | | (12...240)AC | |
| Minimum switching current mA | | 1 | | 50 | |
| Max. "OFF-state" leakage current mA | | 0.01 | | 1 | |
| Max. "ON-state" voltage drop V | | 0.3 | | 1.1 | |
| Input circuit | | | | | |
| Nominal voltage V DC | | 12 | 24 | 12 | 24 |
| Operating range V DC | | 8...17 | 14...32 | 8...17 | 14...32 |
| Control current mA | | 5.5 | 9 | 8.8 | 9 |
| Release voltage V DC | | 4 | 9 | 4 | 9 |
| Impedance Ω | | 1,550 | 2,600 | 1,030 | 2,600 |
| Technical data | | | | | |
| Operate/release time ms | | 0.05/0.25 | | 10/10 | |
| Dielectric strength between input/output V AC | | 2,500 | | 2,500 | |
| Ambient temperature range °C | | -20...+60 | | -20...+60 | |
| Environmental protection | | RT III | | RT III | |
| Approvals (according to type) | | | | | |

Ordering information

Electromechanical relay (EMR)

Example: 41 series low-profile PCB relay, 2 CO (DPDT), 24 V DC coil.

4 1 . 5 2 . 9 . 0 2 4 . 0 0 1 0

A B C D

Series ————

Type ————
 3 = PCB - 3.5 mm pinning
 5 = PCB - 5 mm pinning
 6 = PCB - 5 mm pinning

No. of poles ————
 1 = 1 pole for
 41.31, 12 A
 41.61, 16 A
 2 = 2 pole for
 41.52, 8 A

Coil version ————
 9 = DC

Coil voltage ————
 See coil specifications

A: Contact material
 0 = Standard AgNi
 4 = AgSnO₂
 5 = AgNi + Au (5 µm)

B: Contact circuit
 0 = CO (nPDT)
 3 = NO (nPST)

C: Options
 1 = None

D: Special versions
 0 = Flux proof (RT II)
 1 = Wash tight (RT III)

Selecting features and options: only combinations in the same row are possible.
 Preferred selections for best availability are shown in **bold**.

| Type | Coil version | A | B | C | D |
|-------|--------------|------------------|--------------|----------|--------------|
| 41.31 | DC | 0 - 4 - 5 | 0 - 3 | 1 | 0 - 1 |
| 41.52 | DC | 0 - 5 | 0 - 3 | 1 | 0 - 1 |
| 41.61 | DC | 0 - 4 | 0 - 3 | 1 | 0 - 1 |

Solid state relay (SSR)

Example: 41 series SSR relay, 5 A output, 24 V DC supply.

4 1 . 8 1 . 7 . 0 2 4 . 9 0 2 4

Series ————

Type ————
 8 = SSR type

Output ————
 1 = 1 NO (SPST-NO)

Input circuit ————
 See input specifications

Output circuit
 9024 = 5 A - 24 V DC
 8240 = 3 A - 240 V AC

Electromechanical relay

Technical data

| Insulation according to EN 61810-1 | | | | | |
|--|-------------------------|---------------------|-------------|---------------------|-------------|
| | | 1 pole | | 2 pole | |
| Nominal voltage of supply system | V AC | 230/400 | | 230/400 | |
| Rated insulation voltage | V AC | 250 | 400 | 250 | 400 |
| Pollution degree | | 3 | 2 | 3 | 2 |
| Insulation between coil and contact set | | | | | |
| Type of insulation | | Reinforced (8 mm) | | Reinforced (8 mm) | |
| Overvoltage category | | III | | III | |
| Rated impulse voltage | kV (1.2/50 µs) | 6 | | 6 | |
| Dielectric strength | V AC | 4,000 | | 4,000 | |
| Insulation between adjacent contacts | | | | | |
| Type of insulation | | — | | Basic | |
| Overvoltage category | | — | | III | |
| Rated impulse voltage | kV (1.2/50 µs) | — | | 4 | |
| Dielectric strength | V AC | — | | 2,000 | |
| Insulation between open contacts | | | | | |
| Type of disconnection | | Micro-disconnection | | Micro-disconnection | |
| Dielectric strength | V AC/kV (1.2/50 µs) | 1,000/1.5 | | 1,000/1.5 | |
| Conducted disturbance immunity | | | | | |
| Burst (5...50)ns, 5 kHz, on A1 - A2 | | EN 61000-4-4 | | level 4 (4 kV) | |
| Surge (1.2/50 µs) on A1 - A2 (differential mode) | | EN 61000-4-5 | | level 3 (2 kV) | |
| Other data | | | | | |
| Bounce time: NO/NC | ms | 2/5 | | | |
| Vibration resistance (5...55)Hz: NO/NC | g | 15/2 | | | |
| Shock resistance | g | 16 | | | |
| Power lost to the environment | without contact current | W | 0.4 | | |
| | with rated current | W | 1.7 (41.31) | 1.2 (41.52) | 1.8 (41.61) |
| Recommended distance between relays mounted on PCB | mm | ≥ 5 | | | |

Contact specification

F 41 - Electrical life (AC) v contact current
Types 41.31/61

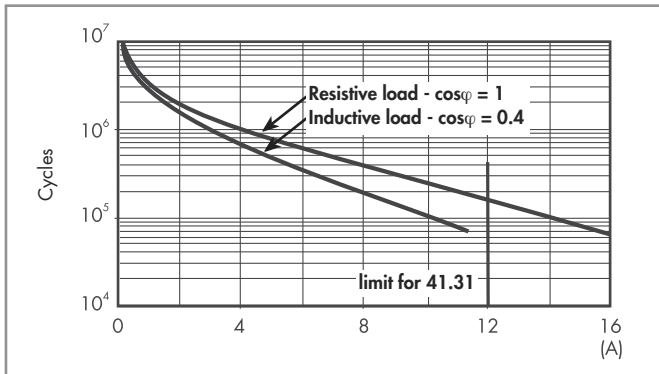

F 41 - Electrical life (AC) v contact current
Type 41.52

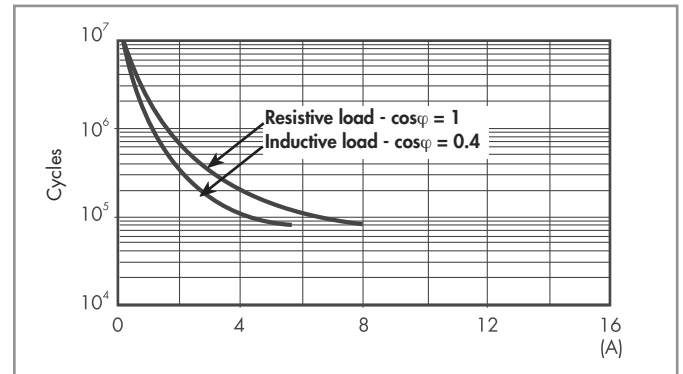

H 41- Maximum DC1 breaking capacity

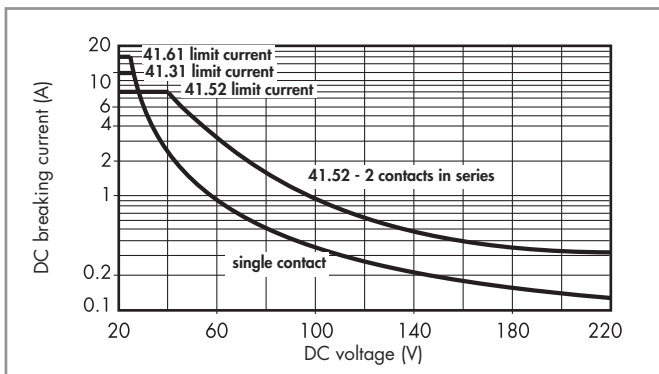

- When switching a resistive load (DC1) having voltage and current values under the curve, an electrical life of $\geq 100 \cdot 10^3$ can be expected.
- In the case of DC13 loads, the connection of a diode in parallel with the load will permit a similar electrical life as for a DC1 load.
Note: the release time for the load will be increased.

Coil specifications

DC coil data

| Nominal voltage U_N V | Coil code | Operating range | | Resistance R Ω | Rated coil consumption I at U_N mA |
|-------------------------------|-----------|-----------------|----------------|-----------------------------|--|
| | | U_{min} V | U_{max} V | | |
| 12 | 9.012 | 8.4 | 18 | 360 | 33.3 |
| 24 | 9.024 | 16.8 | 36 | 1,440 | 16.7 |
| 48 | 9.048 | 33.6 | 72 | 5,760 | 8.3 |
| 60 | 9.060 | 42 | 90 | 9,000 | 6.6 |
| 110 | 9.110 | 77 | 165 | 24,200 | 4.5 |

R 41 - DC coil operating range v ambient temperature

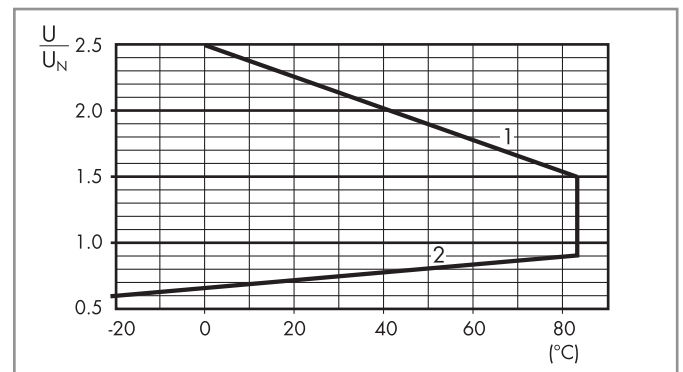

- 1 - Max. permitted coil voltage.
- 2 - Min. pick-up voltage with coil at ambient temperature.

Solid state relay

Technical data

| Other data | | | 41.81 - 9024 | 41.81 - 8240 |
|-------------------------------|----------------------|---|--------------|--------------|
| Power lost to the environment | without current | W | 0.25 | 0.25 |
| | with maximum current | W | 1.75 | 3.5 |

Input specification

Input data - DC types

| Nominal voltage U_N | Input code | Operating range | | Release voltage | Impedance | Control current I at U_N |
|--------------------------|------------|-----------------|-----------|-----------------|-----------|-------------------------------|
| | | U_{min} | U_{max} | | | |
| V | | V | V | V | Ω | mA |
| 12 | 7.012 | 8 | 17 | 4 | 1,550 | 5.5 |
| 24 | 7.024 | 14 | 32 | 9 | 2,600 | 9 |

Output specification

L 41 - Output current v ambient temperature
SSR - 5 A DC output types

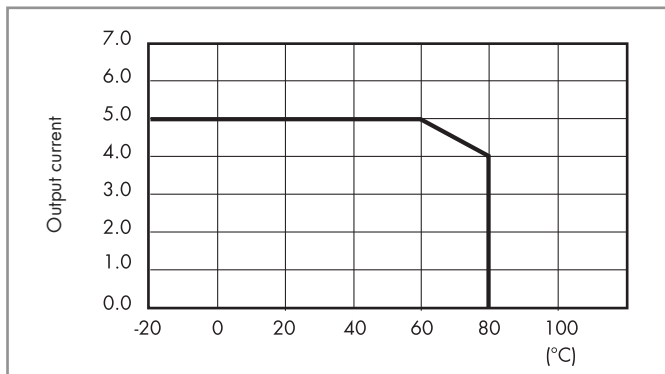

L 41 - Output current v ambient temperature
SSR - 3 A AC output types

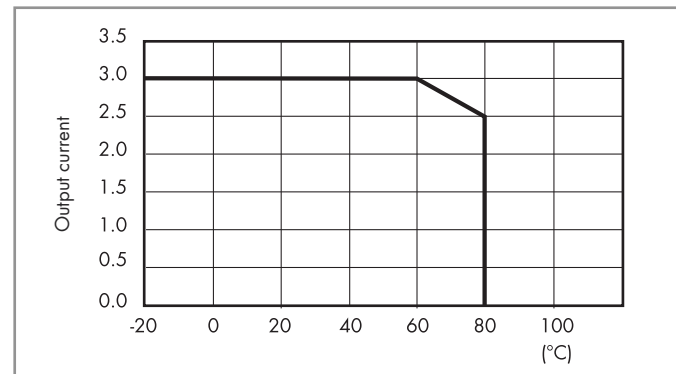



93.02

Approvals
(according to type):



Screw terminal socket 35 mm (EN 60715) mounting

| Supply voltage | Relay type | Socket type |
|--------------------|---|-------------|
| 6 V AC/DC | 41.52.9.005.0010 or 41.61.9.005.0010 | 93.02.0.024 |
| 12 V AC/DC | 41.52.9.012.0010 or 41.61.9.012.0010 | 93.02.0.024 |
| 24 V AC/DC | 41.52/61.9.024.0010 or 41.81.7.024.xxxx | 93.02.0.024 |
| 60 V AC/DC | 41.52.9.060.0010 or 41.61.9.060.0010 | 93.02.0.060 |
| (110...125)V AC/DC | 41.52.9.110.0010 or 41.61.9.110.0010 | 93.02.0.125 |
| (220...240)V AC/DC | 41.52.9.110.0010 or 41.61.9.110.0010 | 93.02.0.240 |
| (230...240)V AC | 41.52.9.110.0010 or 41.61.9.110.0010 | 93.02.8.230 |
| 6 V DC | 41.52.9.005.0010 or 41.61.9.005.0010 | 93.02.7.024 |
| 12 V DC | 41.52/61.9.012.0010 or 41.81.7.012.xxxx | 93.02.7.024 |
| 24 V DC | 41.52/61.9.024.0010 or 41.81.7.024.xxxx | 93.02.7.024 |
| 48 V DC | 41.52.9.048.0010 or 41.61.9.048.0010 | 93.02.7.060 |
| 60 V DC | 41.52.9.060.0010 or 41.61.9.060.0010 | 93.02.7.060 |

Accessories

| | |
|-------------------------------|--------------------------------------|
| 8-way jumper link | 093.08 (see specification next page) |
| Plastic separator | 093.01 (see specification next page) |
| Sheet of marker tags, 72 tags | 060.72 (see specification next page) |

Technical data

| | | | |
|---|--|---------------|-------------|
| Rated values | 10 A - 250 V | | |
| Dielectric strength | 6 kV (1.2/50 μs) between coil and contacts | | |
| Protection category | IP 20 | | |
| Ambient temperature (U _N ≤ 60 V / > 60 V) °C | -40...+70 / -40...+55 | | |
| ⊕ Screw torque | Nm | 0.5 | |
| Wire strip length | mm | 8 | |
| Max. wire size for 93.02 socket | solid wire | stranded wire | |
| | mm ² | 1x6 / 2x2.5 | 1x4 / 2x2.5 |
| | AWG | 1x10 / 2x14 | 1x12 / 2x14 |

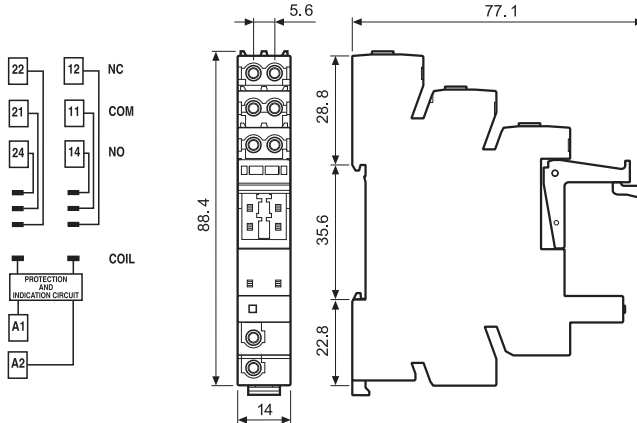



93.52

Approvals
(according to type):

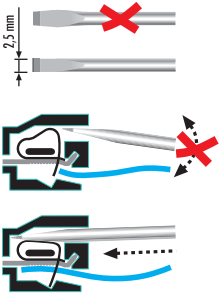

Screwless terminal socket 35 mm (EN 60715) mounting

| Supply voltage | Relay type | Socket type |
|--------------------|---|-------------|
| 6 V AC/DC | 41.52.9.005.0010 or 41.61.9.005.0010 | 93.52.0.024 |
| 12 V AC/DC | 41.52.9.012.0010 or 41.61.9.012.0010 | 93.52.0.024 |
| 24 V AC/DC | 41.52/61.9.024.0010 or 41.81.7.024.xxxx | 93.52.0.024 |
| 60 V AC/DC | 41.52.9.060.0010 or 41.61.9.060.0010 | 93.52.0.060 |
| (110...125)V AC/DC | 41.52.9.110.0010 or 41.61.9.110.0010 | 93.52.0.125 |
| (220...240)V AC/DC | 41.52.9.110.0010 or 41.61.9.110.0010 | 93.52.0.240 |
| (230...240)V AC | 41.52.9.110.0010 or 41.61.9.110.0010 | 93.52.8.230 |
| 6 V DC | 41.52.9.005.0010 or 41.61.9.005.0010 | 93.52.7.024 |
| 12 V DC | 41.52/61.9.012.0010 or 41.81.7.012.xxxx | 93.52.7.024 |
| 24 V DC | 41.52/61.9.024.0010 or 41.81.7.024.xxxx | 93.52.7.024 |
| 48 V DC | 41.52.9.048.0010 or 41.61.9.048.0010 | 93.52.7.060 |
| 60 V DC | 41.52.9.060.0010 or 41.61.9.060.0010 | 93.52.7.060 |

Accessories

| | |
|-------------------------------|--------------------------|
| 8-way jumper link | 093.08 (see table below) |
| Plastic separator | 093.01 (see table below) |
| Sheet of marker tags, 72 tags | 060.72 (see table below) |

Technical data

| | | |
|---|--|---------------|
| Rated values | 10 A - 250 V | |
| Dielectric strength | 6 kV (1.2/50 μs) between coil and contacts | |
| Protection category | IP 20 | |
| Ambient temperature (U _N ≤ 60 V / > 60 V) °C | -40...+70 / -40...+55 | |
| Wire strip length | mm | 8 |
| Max. wire size for 93.52 socket | solid wire | stranded wire |
| | mm ² | 1x2.5 |
| | AWG | 1x14 |

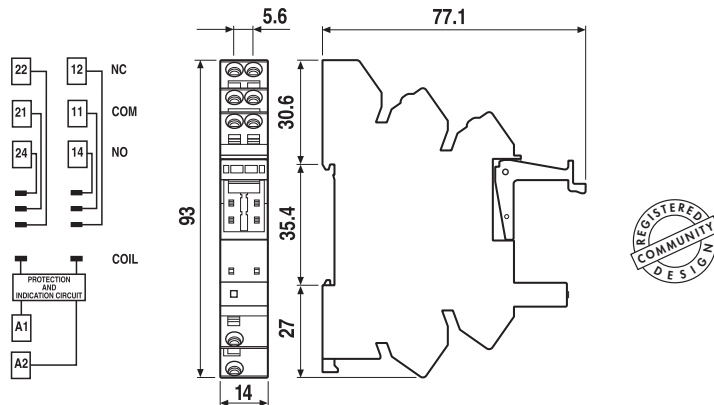

Accessories



093.08

Approvals
(according to type):



| | | | |
|--|---------------|------------------|----------------|
| 8-way jumper link for 93.02 and 93.52 sockets | 093.08 (blue) | 093.08.0 (black) | 093.08.1 (red) |
| Rated values | 10 A - 250 V | | |

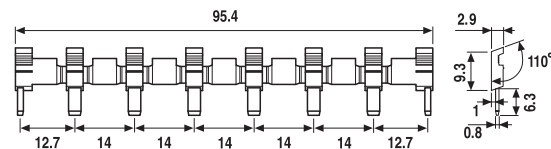

| | |
|--|--------|
| Plastic separator for 93.02 and 93.52 sockets | 093.01 |
|--|--------|

Thickness 2 mm, required at the start and the end of a group of interfaces.

Can be used for visual separation group, must be used for:

- protective separation of different voltages of neighbouring PLC interfaces according to VDE 0106-101
- protection of cut jumper links



093.01

| | |
|--|--------|
| Sheet of marker tags for 38.x2, plastic, 72 tags, 6x12 mm | 060.72 |
|--|--------|

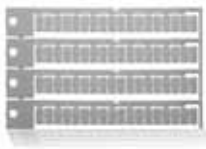

060.72



95.13.2



95.15.2

Approvals
(according to type):



| PCB socket | 95.13.2 (blue) | 95.13.20 (black) | 95.15.2 (blue) | 95.15.20 (black) |
|------------------------|--|------------------|------------------------------------|------------------|
| For relay type | 41.31 | | 41.52, 41.61, 41.81 ⁽¹⁾ | |
| Accessories | | | | |
| Plastic retaining clip | | | | 095.42 |
| Technical data | | | | |
| Rated values | 10 A - 250 V * | | | |
| Dielectric strength | 6 kV (1.2/50 μs) between coil and contacts | | | |
| Protection category | IP 20 | | | |
| Ambient temperature | °C -40...+70 | | | |

* For currents >10 A, contact terminals must be connected in parallel (21 with 11, 24 with 14, 22 with 12).

⁽¹⁾ With the relay 41.81 the NO change-over contact will be 11-14.

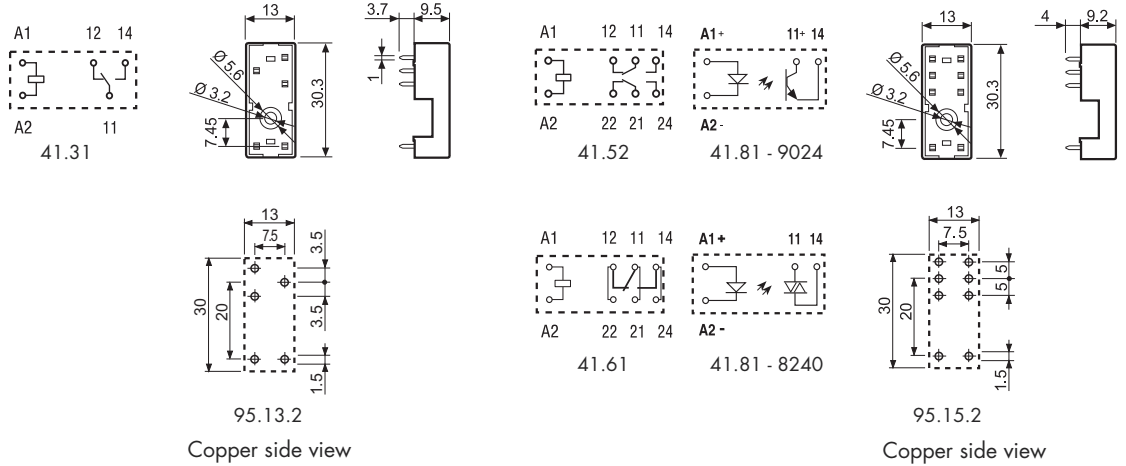

Packaging codes

How to code and identify retaining clip and packaging options for sockets.

Example:



A Standard packaging

SL Plastic retaining clip



Without retaining clip

