





3.0 Amp. Glass Passivated Junction Rectifier

 <p>DO-201AD (DO-27)</p>	Voltage 50V to 1000 V	Current 3.0 A at 105° C	
			
	FEATURES <ul style="list-style-type: none"> Glass passivated chip junction Hyperrectifier structure for high reliability Cavity-free glass-passivated junction Low forward voltage drop Low leakage current, typical I_R less than 0.1 μA High forward surge capability Solder dip 260°C, 10s AEC-Q101 qualified Component in accordance to RoHS 2011/65/EU and WEEE 2002/96/EC 		   RoHS COMPLIANT
	MECHANICAL DATA <ul style="list-style-type: none"> Case: DO-201AD (DO-27). Epoxy meets UL 94V-0 flammability rating. Polarity: Color band denotes cathode end Terminals: Matte tin plated leads, solderable per MIL-STD-750 Method 2026, J-STD-002 and JESD22-B102. Consumer grade, meets JESD 201 class 1A whisker test. HE3 suffix for high reliability grade, meets JESD 201 class 2 whisker test. 		
TYPICAL APPLICATIONS Used in general purpose rectification of power supplies, inverters, converters and freewheeling diodes for consumer, automotive and telecommunication.			

Maximun Ratings and Electrical Characteristics at 25°C

		1N5400GP	1N5401GP	1N5402GP	1N5404GP	1N5406GP	1N5407GP	1N5408GP
V _{RRM}	Peak Recurrent Reverse Voltage (V)	50	100	200	400	600	800	1000
I _{F(AV)}	Forward Current at Tamb = 105 °C	3.0 A						
I _{FRM}	Recurrent Peak Forward Current	30 A						
I _{FSM}	8.3 ms. Peak Forward Surge Current (Jedec Method)	200 A						
T _j	Operating Temperature Range	-65 to +175°C						
T _{stg}	Storage Temperature Range	-65 to +175°C						
E _{RSM}	Maximum non Repetitive Peak Reverse Avalanche energy. I _R = 1A; T _j = 25 °C	20 mJ						

Electrical Characteristics at Tamb = 25°C

V _F	Maximum Forward Voltage Drop at I _F = 3A	1.2 V
I _R	Maximum Reverse Current at V _{RRM} at 25°C at 150°C	5 μA 500 μA
R _{thj-a}	Maximum Thermal Resistance (l = 10mm.)	30 °C/W

3.0 Amp. Glass Passivated Junction Rectifier

Ordering information

PREFERRED P/N	PACKAGE CODE	DELIVERY MODE	BASE QUANTITY	UNIT WEIGHT (g)
1N5402GP AMP	AMP	AMMO BOX	1,500	1.100
1N5402GP TR	TR	14" diameter tape and reel	1,500	1.100
1N5402GP HE3 AMP	AMP	AMMO BOX	1,500	1.100
1N5402GP HE3 TR	TR	14" diameter tape and reel	1,500	1.100

Package Outline Dimensions: (mm) DO-201AD (DO-27)

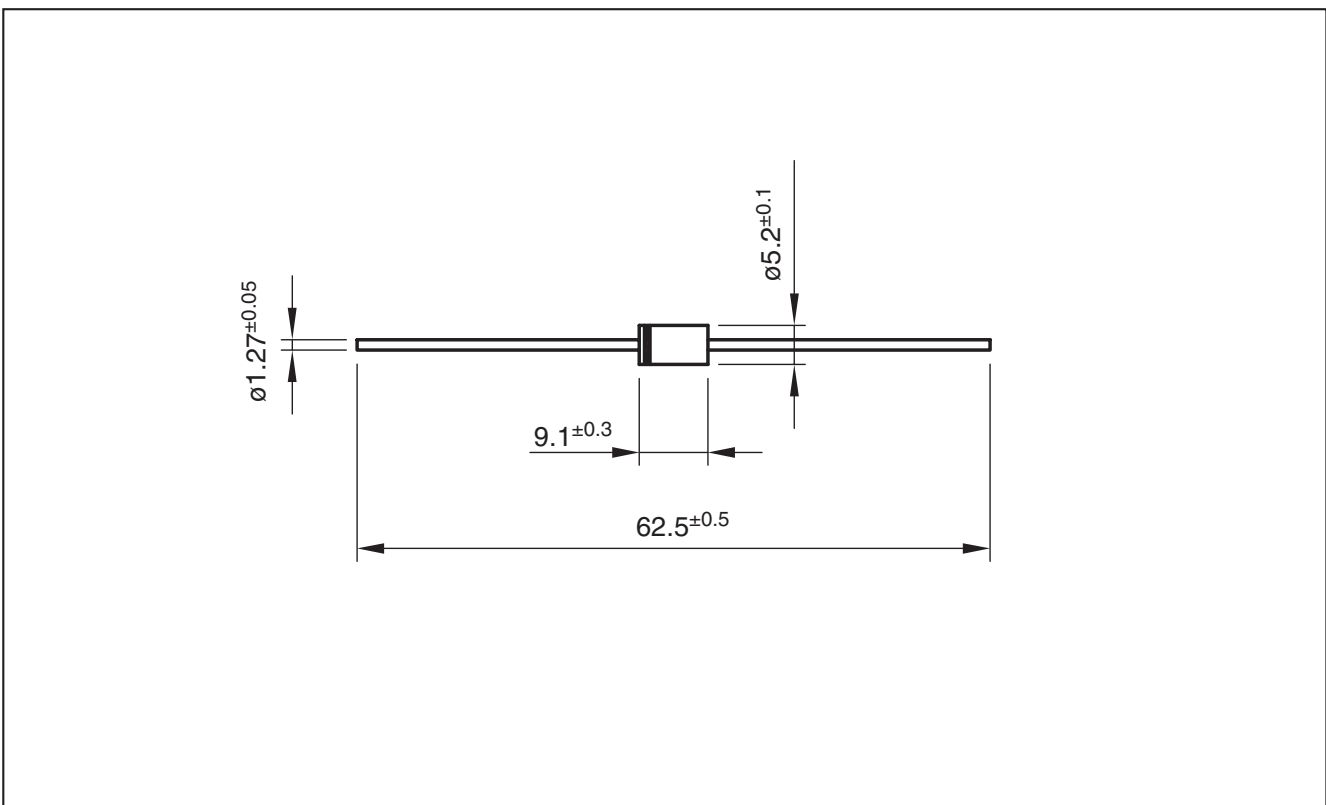

3.0 Amp. Glass Passivated Junction Rectifier

Ratings and Characteristics (Ta 25 °C unless otherwise noted)

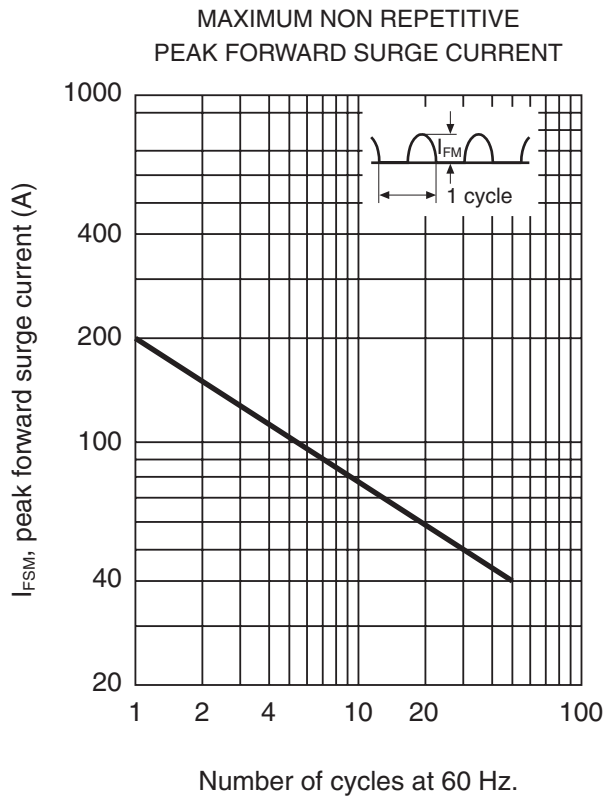
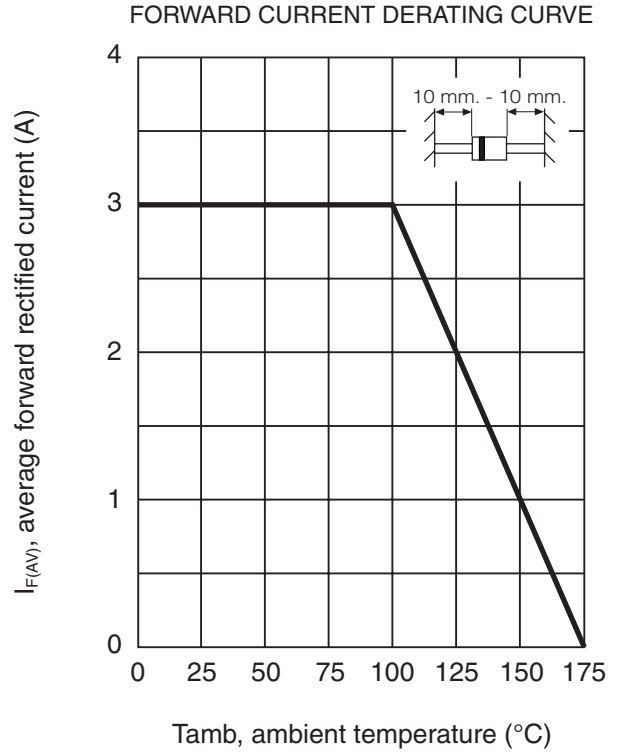
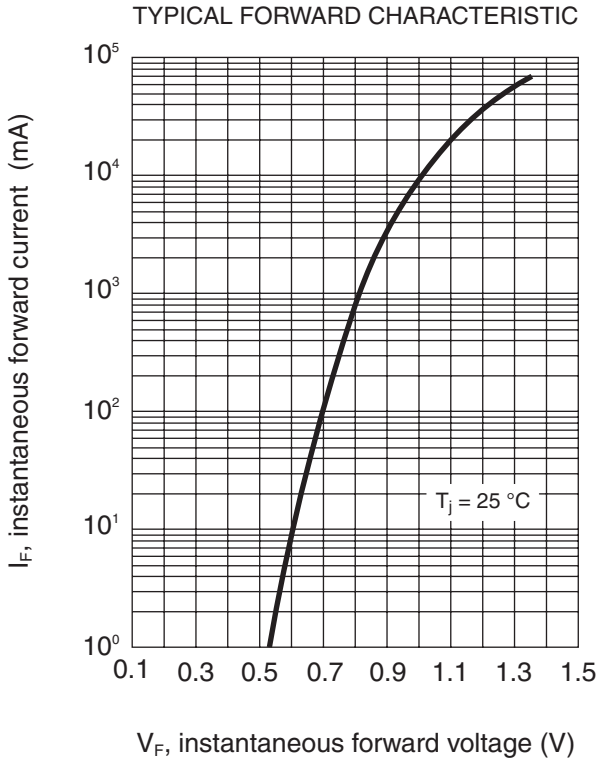

3.0 Amp. Glass Passivated Junction Rectifier

Revision History

Date	Revision	Description of Changes
12-Jul-2012	0	Original Data Sheet
04-Jun-2015	1	Add HE3

Disclaimer

All product, product specifications and data are subject to change without notice to improve reliability, function or design or otherwise.

Fagor Electrónica, S.Coop., its affiliates, agents, and employees, and all persons acting on its or their behalf (collectively, "Fagor"), disclaim any and all liability for any errors, inaccuracies or incompleteness contained in any datasheet or in any other disclosure relating to any product.

Fagor makes no warranty, representation or guarantee regarding the suitability of the products for any particular purpose or the continuing production of any product. To the maximum extent permitted by applicable law, Fagor disclaims (i) any and all liability arising out of the application or use of any product, (ii) any and all liability, including without limitation special, consequential or incidental damages, and (iii) any and all implied warranties, including warranties of fitness for particular purpose, non-infringement and merchantability.

Statements regarding the suitability of products for certain types of applications are based on Fagor's knowledge of typical requirements that are often placed on Fagor products in generic applications. Such statements are not binding statements about the suitability of products for a particular application. It is the customer's responsibility to validate that a particular product with the properties described in the product specification is suitable for use in a particular application. Parameters provided in datasheets and/or specifications may vary in different applications and performance may vary over time. All operating parameters, including typical parameters, must be validated for each customer application by the customer's technical experts. Product specifications do not expand or otherwise modify Fagor's terms and conditions of purchase, including but not limited to the warranty expressed therein.

Except as expressly indicated in writing, Fagor products are not designed for use in medical, life-saving, or life-sustaining applications or for any other application in which the failure of the Fagor product could result in personal injury or death. Customers using or selling Fagor products not expressly indicated for use in such applications do so at their own risk and agree to fully indemnify and hold Fagor and its distributors harmless from and against any and all claims, liabilities, expenses and damages arising or resulting in connection with such use or sale, including attorneys fees, even if such claim alleges that Fagor or its distributor was negligent regarding the design or manufacture of the part. Please contact authorized Fagor personnel to obtain written terms and conditions regarding products designed for such applications.

No license, express or implied, by estoppel or otherwise, to any intellectual property rights is granted by this document or by any conduct of Fagor, Product names and markings noted herein may be trademarks of their respective owners.