

Description

Single pole miniaturised magnetic circuit breakers with unique high-speed operating mechanism and push/pull on/off manual actuation. Fitted with electrically separate excitation and switching circuits, and one pair of auxiliary contacts which close when the main circuit is open. Also suitable for impulse operation. Designed for printed circuit board mounting. Low temperature sensitivity.

Typical applications

Printed circuit boards and components, safety and control systems.

Ordering information

Type No.	
808	fast-acting
	Manual release
H	manual release facility
	Current ratings
	0.01...5 A
808 - H - 5 A ordering example	

Please be informed that we have minimum ordering quantities to be observed.

Preferred types

Preferred types	Standard current ratings (A)										
	0.02	0.05	0.1	0.3	0.4	0.5	0.6	1	2	3	5
808-H-	x	x	x	x	x	x	x	x	x	x	x

Standard current ratings and typical internal resistance values

Current rating (A)	Internal resistance (Ω)	Current rating (A)	Internal resistance (Ω)
0.01	625	0.8	0.096
0.02	170	0.9	0.085
0.03	77	1	0.073
0.04	47	1.2	0.050
0.05	29.2	1.5	0.031
0.08	10.3	2	≤ 0.02
0.1	5.6	2.5	≤ 0.02
0.2	1.65	3	≤ 0.02
0.3	0.89	3.25	≤ 0.02
0.4	0.39	4	≤ 0.02
0.5	0.28	4.5	≤ 0.02
0.6	0.198	5	≤ 0.02
0.7	0.143		

Approvals

Authority	Standard	Rated voltage	Current ratings
UL	UL 1077	AC 120 V DC 60 V	0.006 A...8 A 0.006 A...8 A
	C22.2 No 235	AC 120 V DC 60 V	0.006 A...5 A 0.006 A...8 A
CSA	C22.2 No 235	AC 120 V DC 60 V	0.01...5 A 0.01...8 A



808

Technical data

For further details please see: http://www.e-t-a.de/ti_e

Voltage rating	DC 24 V (higher voltages to special order) UL: AC 120 V; DC 60 V	
Current ratings	0.01...5 A (higher current ratings to special order)	
Max. continuous load excitation circuit (2-3)	2.65 x I _N	
Max. continuous load switching circuit 6-7 auxiliary circuit 4-5	5 A	
Typical life	6,000 operations at 5 A for switching circuit	
Ambient temperature	-30...+70 °C (-22...+158 °F)	
Insulation co-ordination (IEC 60664-1)	rated impulse withstand voltage 1.5 kV	pollution degree 2
Dielectric strength (UL 1077) operating area excitation to switching circuit excitation to auxiliary circuit	test voltage AC 1,240 V AC 1,240 V AC 1,240 V	
Insulation resistance	> 100 MΩ (DC 500 V)	
Interrupting capacity (o-o-o)	100 A	
Interrupting capacity (UL 1077)	2,000 A AC 120 V 1,000 A DC 60 V	
Degree of protection (IEC 60529/DIN 40050)	operating area IP30 terminal area IP00	
Vibration	3 g (57-500 Hz), ± 0.23 mm (10-57 Hz), to IEC 60068-2-6, test Fc 10 frequency cycles/axis	
Shock	25 g (11 ms) to IEC 60068-2-27, test Ea	
Corrosion	48 hours at 5 % salt mist, to IEC 60068-2-11, test Ka	
Humidity	240 hours at 95 % RH to IEC 60068-2-78, test Cab	
Mass	approx. 10 g	

Dimensions

808-H

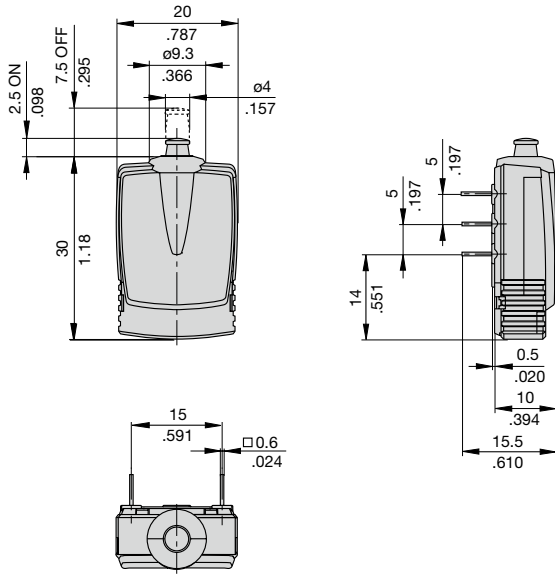

Internal connection diagram

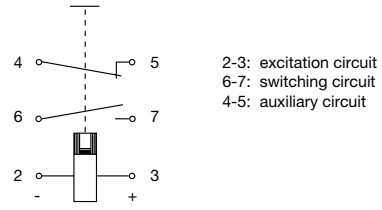

Typical time/current characteristics at +23 °C/+73.4 °F

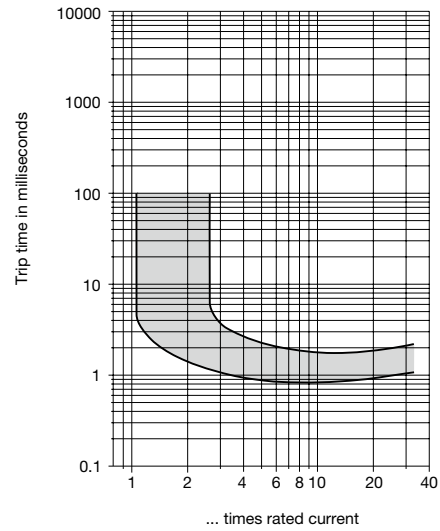

This is a metric design and millimeter dimensions take precedence ($\frac{mm}{inch}$)

All dimensions without tolerances are for reference only. In the interest of improved design, performance and cost effectiveness the right to make changes in these specifications without notice is reserved. Product markings may not be exactly as the ordering codes. Errors and omissions excepted.