

# TL6275 SERIES TACT SWITCH

ANTI-VANDAL SWITCHES  
 DETECTOR SWITCHES  
 DIP SWITCHES  
 KEYLOCK SWITCHES  
 NAVIGATION SWITCHES  
 PUSHBUTTON SWITCHES  
 ROCKER SWITCHES  
 ROTARY SWITCHES  
 SLIDE SWITCHES  
 SNAP ACTION SWITCHES  
**TACTILE SWITCHES**  
 TOGGLE SWITCHES  
 CAP OPTIONS

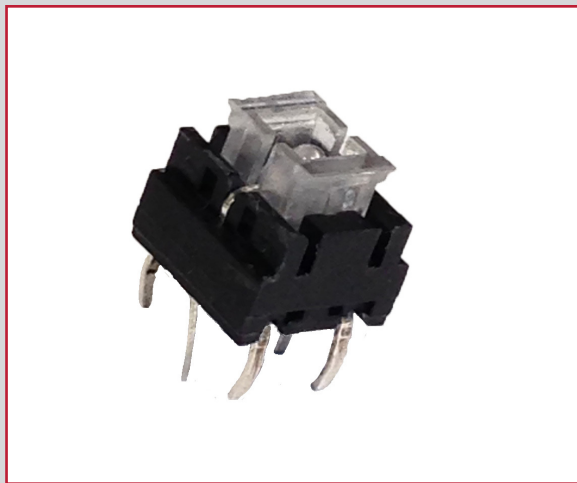

## APPLICATIONS / MARKETS



Audio / Visual

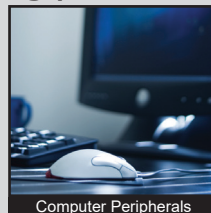

Computer Peripherals



Consumer Electronics



Instrumentation



Security Devices



Medical Equipment

**RoHS**

## SPECIFICATIONS

**Contact Arrangement:** SPST  
**Contact Rating:** 50mA @ 12VDC  
**Contact Resistance:** 100mΩ Initial  
**Insulation Resistance:** 100 MΩ Min.  
**Dielectric Strength:** 250V RMS  
**Electrical Life:** 100,000 cycles  
**Operating Temperature:** -25°C to 70°C  
**Storage Temperature:** -25°C to 70°C  
**Travel:** 0.25mm  
**Actuation Force:** 350 gf

## FEATURES & BENEFITS

- 100,000 cycle life expectancy
- Multiple cap options
- Illumination options
- PCB Mount
- Capable to withstand a typical water wash

## PART NUMBER CONFIGURATOR

Series



TL6275

Actuator



**A** - Clear 7.20 Actuator (No Cap)  
**B** - Clear 9.05 Actuator

Housing



**A2** - Standard Housing

Termination



**P** - Thru Hole PCB Pins

Contact Material



**Q** - Silver

Cap Options

(Only with B - Actuator)



**N** - None  
**R** - Opaque 7.4 Rounded  
**S** - Transparent 7.4 Square  
**T** - Translucent High 6.0 Square  
**U** - Translucent High 6.0 Circle

LED Color



**R** - Red  
**B** - Blue  
**G** - Green  
**W** - White  
**Y** - Yellow

Specifications subject to change without notice 5.18.2019



**E-SWITCH®**

www.e-switch.com

800.867.2717

1

# TL6275 SERIES TACT SWITCH

## BODY DIMENSIONS A - ACTUATOR

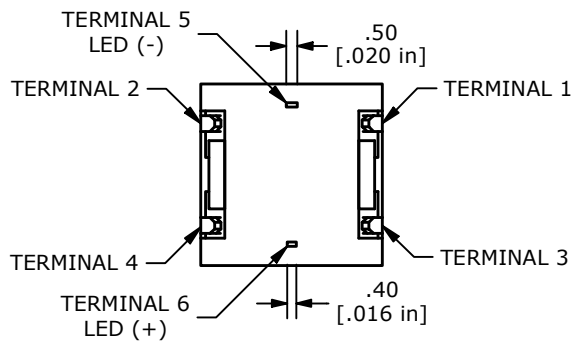
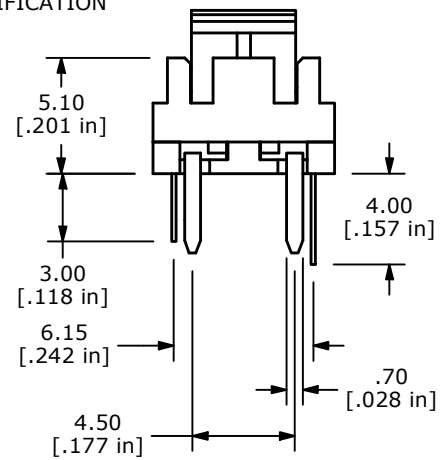
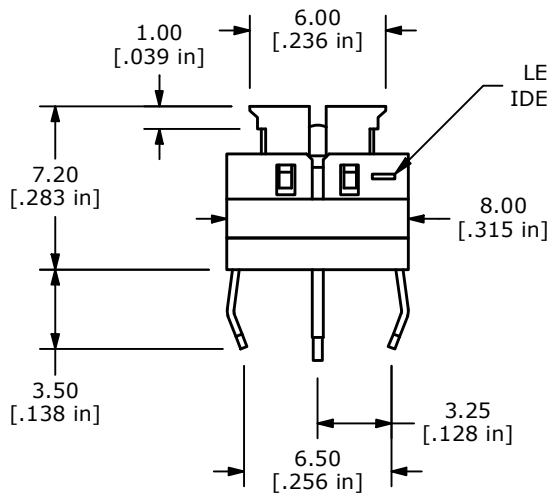
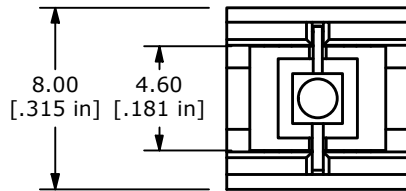
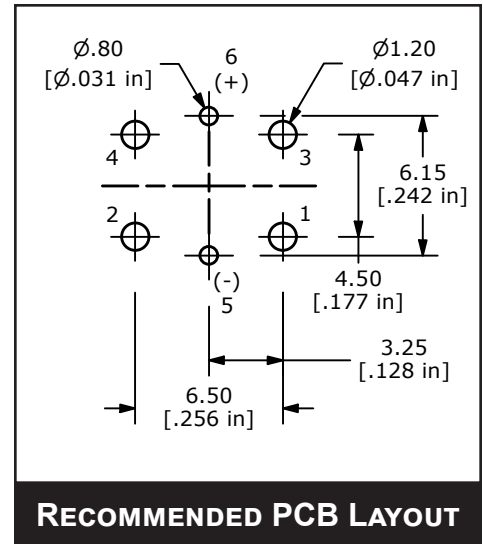
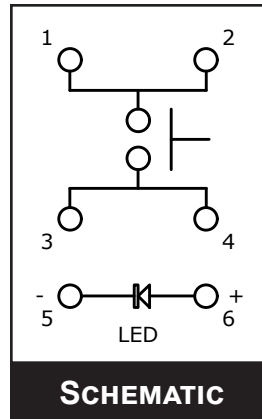

ANTI-VANDAL SWITCHES  
DETECTOR SWITCHES  
DIP SWITCHES  
KEYLOCK SWITCHES  
NAVIGATION SWITCHES  
PUSHBUTTON SWITCHES  
ROCKER SWITCHES  
ROTARY SWITCHES  
SLIDE SWITCHES  
SNAP ACTION SWITCHES  
TACTILE SWITCHES  
TOGGLE SWITCHES  
CAP OPTIONS

# TL6275 SERIES TACT SWITCH

## BODY DIMENSIONS B - ACTUATOR

- ANTI-VANDAL SWITCHES
- DETECTOR SWITCHES
- DIP SWITCHES
- KEYLOCK SWITCHES
- NAVIGATION SWITCHES
- PUSHBUTTON SWITCHES
- ROCKER SWITCHES
- ROTARY SWITCHES
- SLIDE SWITCHES
- SNAP ACTION SWITCHES
- TACTILE SWITCHES**
- TOGGLE SWITCHES
- CAP OPTIONS

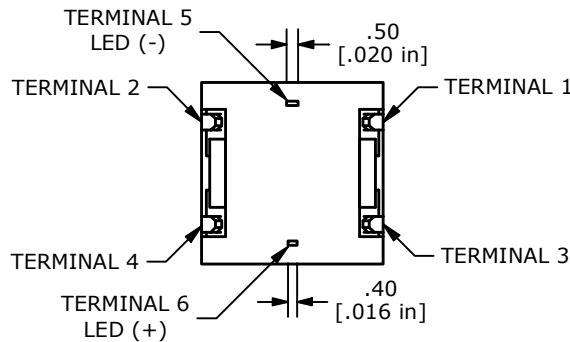
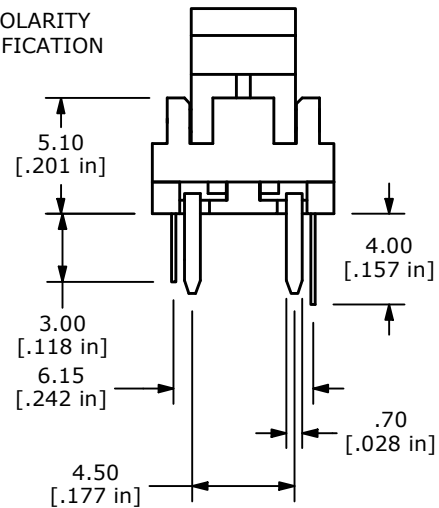
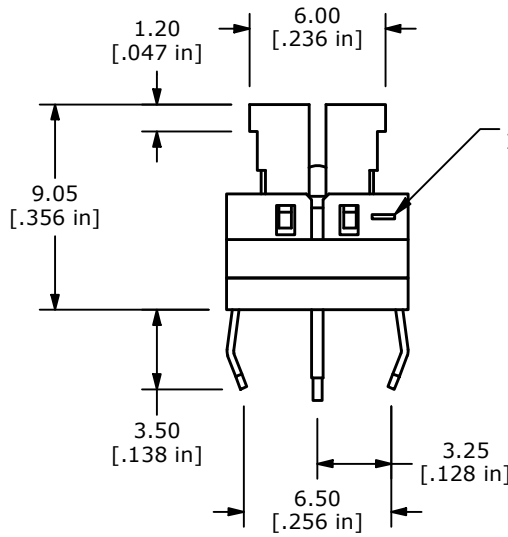
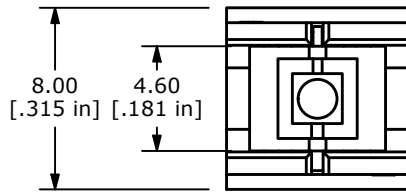
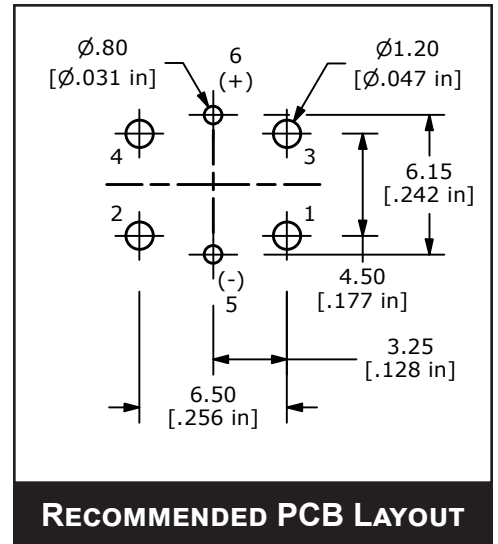
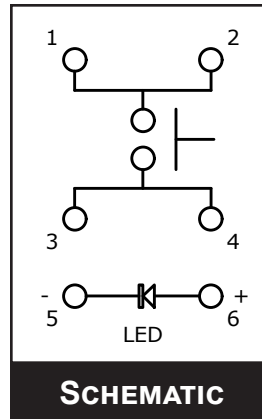

# TL6275 SERIES TACT SWITCH

## BODY DIMENSIONS S - TRANSPARENT 7.4 SQUARE

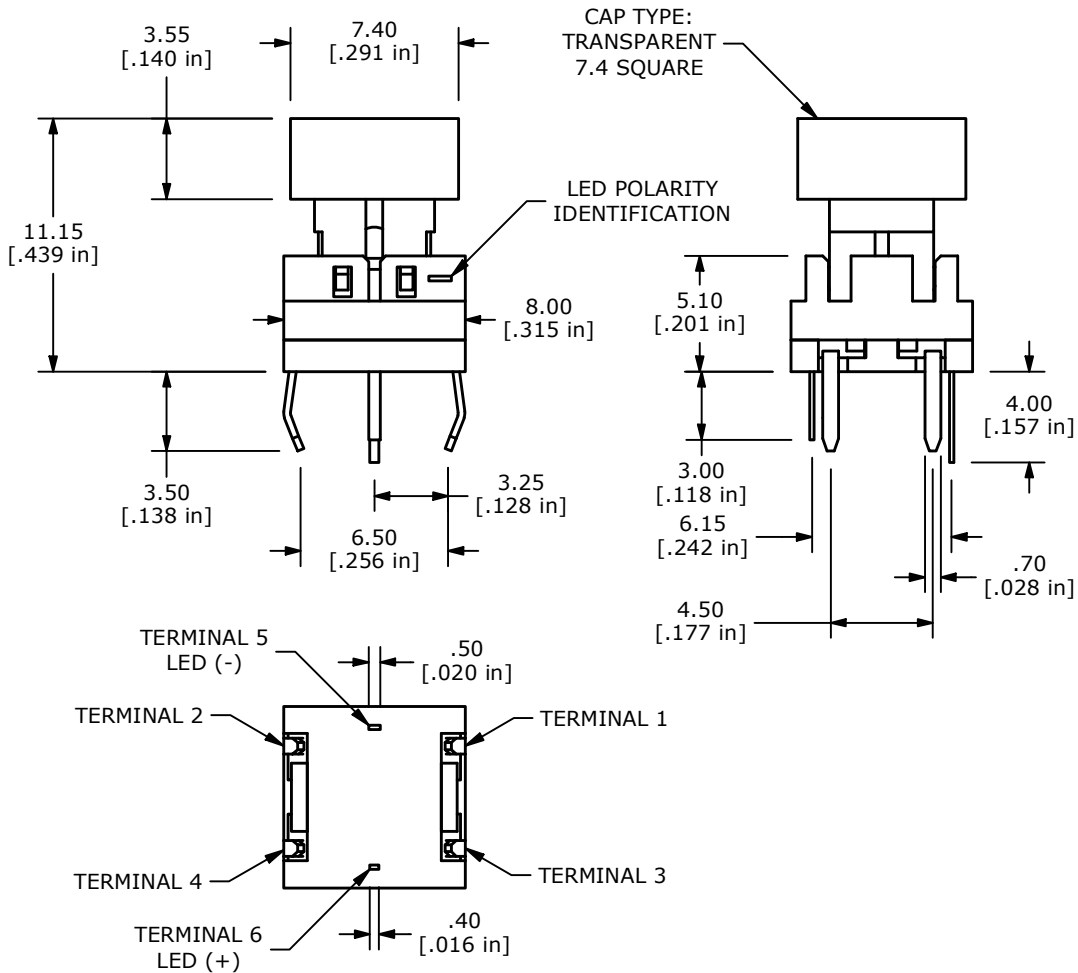
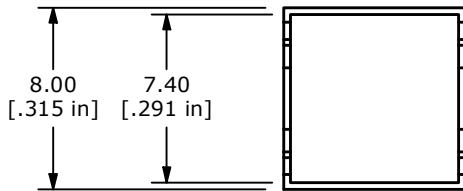
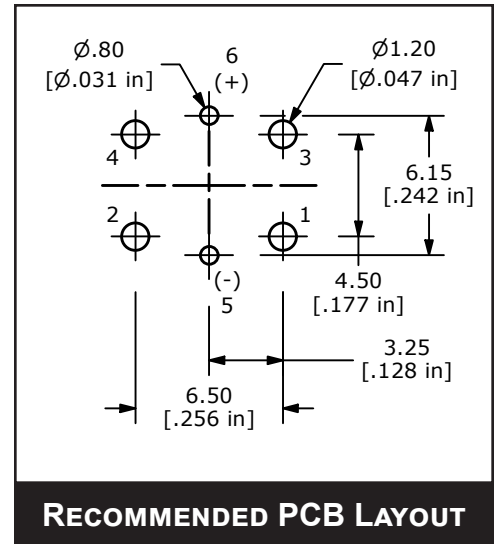
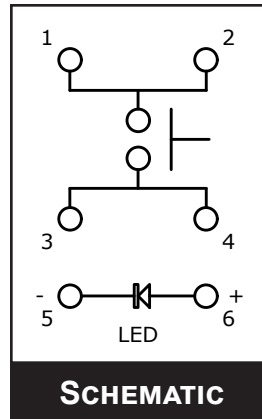

ANTI-VANDAL SWITCHES  
DETECTOR SWITCHES  
DIP SWITCHES  
KEYLOCK SWITCHES  
NAVIGATION SWITCHES  
PUSHBUTTON SWITCHES  
ROCKER SWITCHES  
ROTARY SWITCHES  
SLIDE SWITCHES  
SNAP ACTION SWITCHES  
TACTILE SWITCHES  
TOGGLE SWITCHES  
CAP OPTIONS

# TL6275 SERIES TACT SWITCH

## BODY DIMENSIONS T - TRANSLUCENT 6.0 SQUARE

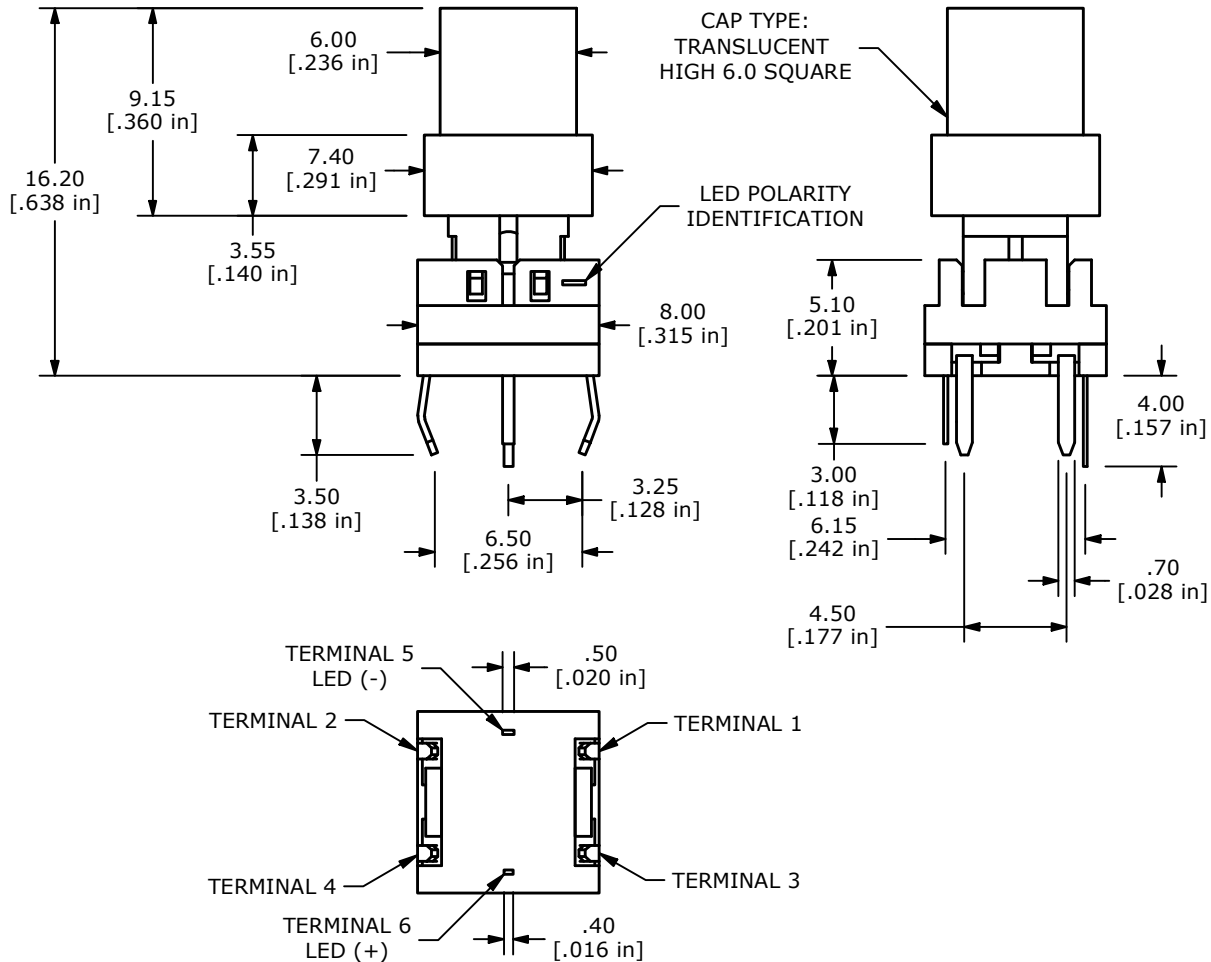
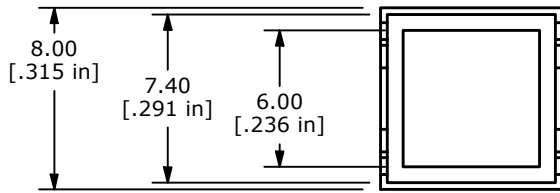
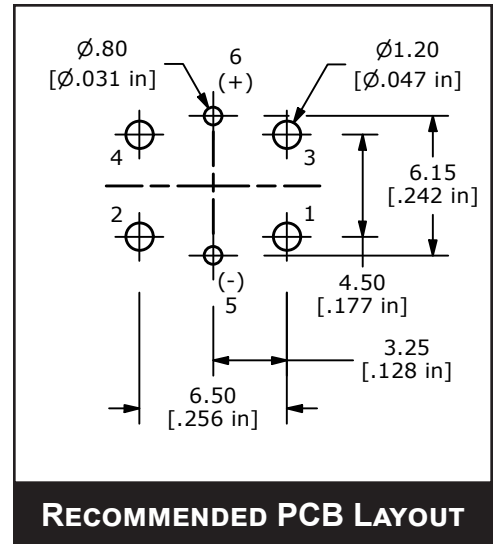
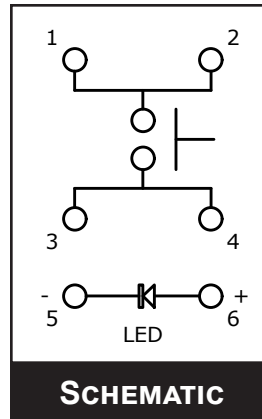

# TL6275 SERIES TACT SWITCH

## CAP OPTIONS

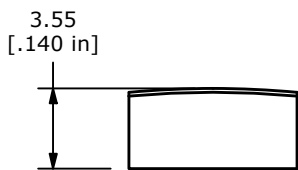
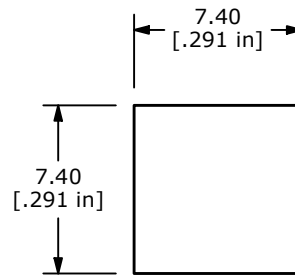
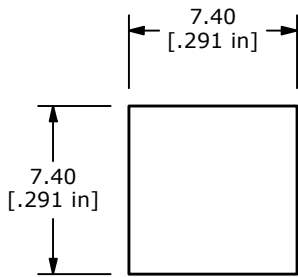

R - Opaque 7.40 Rounded

**R - OPAQUE  
7.4 ROUNDED**

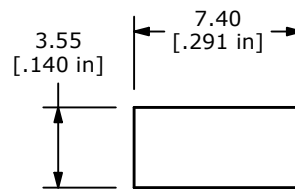

S - Transparent 7.40 Square

**S - TRANSPARENT  
7.4 SQUARE**

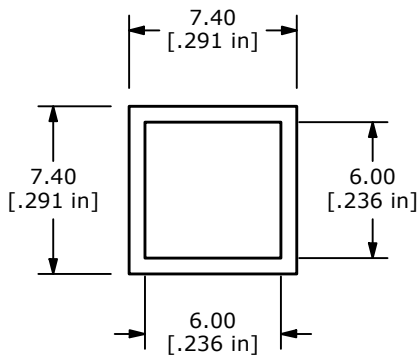

T - Translucent High 6.00 Square

**T - TRANSLUCENT  
HIGH 6.0 SQUARE**

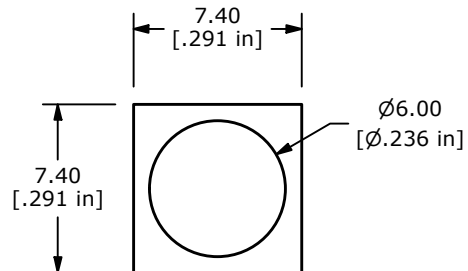

U - Translucent High 6.0 Circle

**U - TRANSLUCENT  
HIGH 6.0 CIRCLE**

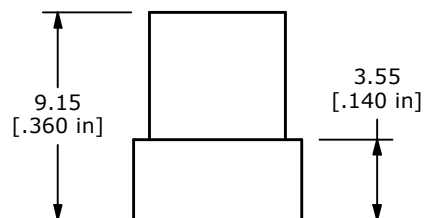
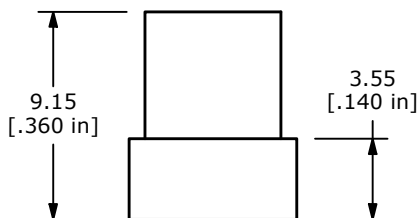

ANTI-VANDAL SWITCHES  
DETECTOR SWITCHES  
DIP SWITCHES  
KEYLOCK SWITCHES  
NAVIGATION SWITCHES  
PUSHBUTTON SWITCHES  
ROCKER SWITCHES  
ROTARY SWITCHES  
SLIDE SWITCHES  
SNAP ACTION SWITCHES  
TACTILE SWITCHES  
TOGGLE SWITCHES  
CAP OPTIONS