

UNCONTROLLED DOCUMENT

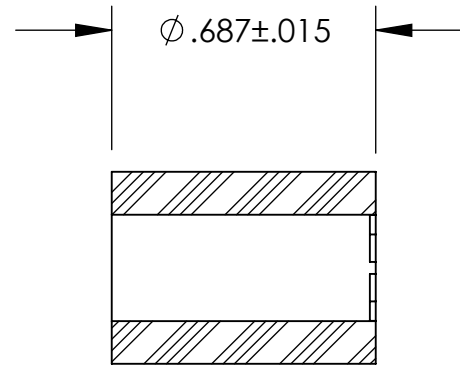
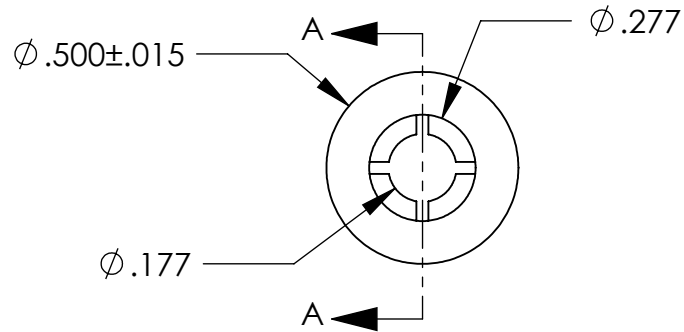

TOLERANCES UNLESS NOTED

- $\pm .005$ ON DIMENSIONS THRU $.625$
- $\pm .008$ ON DIMENSIONS $.626$ THRU 1.000
- $\pm .010$ ON DIMENSIONS 1.001 THRU 1.500
- $\pm .015$ ON DIMENSIONS LARGER THAN 1.500
- $\pm .015$ ON FRACTIONAL DIMENSIONS

WE RESERVE THE RIGHT
 TO DISCONTINUE ITEMS,
 CHANGE SPECIFICATIONS
 OR DESIGN AT ANY TIME
 WITHOUT NOTICE AND
 WITHOUT INCURRING
 ANY OBLIGATIONS

PROPERTY OF
MICRO PLASTICS INC.

CATALOG DRAWING
 RETAINING SPACER
 MICRO P/N 13SPRT100
 DWG. # 13SPRT100
 FILE SERVER\ENG\WEB

MATERIAL: 6/6 NYLON

DATE

SCALE
2:1

TA