

Model Number	Type of Connector	Voltage	Max. Load (Convection) (112.5W) @50°C	Max. Load (Convection) (120W) @40°C	Max. Load (13 CFM)	Min. Load	Ripple ¹	Signal
ULP180-1012	Header Molex @ I/P Screw Terminal @ O/P	12 V	9.37A	10.00A	15.00A	0.0 A	2%	N.A
ULP180-1312	Header Molex @ I/P Header Molex @ O/P	12 V	9.37A	10.00A	15.00A	0.0 A	2%	N.A
ULP180-1015	Header Molex @ I/P Screw Terminal @ O/P	15 V	7.50A	8.00A	12.00A	0.0 A	2%	N.A
ULP180-1315	Header Molex @ I/P Header Molex @ O/P	15 V	7.50A	8.00A	12.00A	0.0 A	2%	N.A
ULP180-1024	Header Molex @ I/P Screw Terminal @ O/P	24 V	4.68A	5.00A	7.50A	0.0 A	1%	N.A
ULP180-1324	Header Molex @ I/P Header Molex @ O/P	24 V	4.68A	5.00A	7.50A	0.0 A	1%	N.A
ULP180-1030	Header Molex @ I/P Screw Terminal @ O/P	30 V	3.75A	4.00A	6.00A	0.0 A	1%	N.A
ULP180-1330	Header Molex @ I/P Header Molex @ O/P	30 V	3.75A	4.00A	6.00A	0.0 A	1%	N.A
ULP180-1048	Header Molex @ I/P Screw Terminal @ O/P	48 V	2.34A	2.50A	3.75A	0.0 A	1%	N.A
ULP180-1348	Header Molex @ I/P Header Molex @ O/P	48 V	2.34A	2.50A	3.75A	0.0 A	1%	N.A
ULP180-1058	Header Molex @ I/P Screw Terminal @ O/P	58 V	1.94A	2.07A	3.10A	0.0 A	1%	N.A
ULP180-1358	Header Molex @ I/P Header Molex @ O/P	58 V	1.94A	2.07A	3.10A	0.0 A	1%	N.A
ULP180-CK metal cover kit accessory								



Innovations in Power

Model Number	Type of Connector	Voltage	Max. Load (Convection) (112.5W) @50°C	Max. Load (Convection) (120W) @40°C	Max. Load (13 CFM)	Min. Load	Ripple ¹	Signal
ULP180-0012	Header Molex @ I/P	12 V	9.37A	10.00A	15.00A	0.0 A	2%	PG & AC PF ¹¹
ULP180-0312	Screw Terminal @ O/P							
ULP180-0312	Header Molex @ I/P	12 V	9.37A	10.00A	15.00A	0.0 A	2%	PG & AC PF ¹¹
ULP180-0312	Header Molex @ O/P							
ULP180-0015	Header Molex @ I/P	15 V	7.50A	8.00A	12.00A	0.0 A	2%	PG & AC PF ¹¹
ULP180-0315	Screw Terminal @ O/P							
ULP180-0315	Header Molex @ I/P	15 V	7.50A	8.00A	12.00A	0.0 A	2%	PG & AC PF ¹¹
ULP180-0315	Header Molex @ O/P							
ULP180-0024	Header Molex @ I/P	24 V	4.68A	5.00A	7.50A	0.0 A	1%	PG & AC PF ¹¹
ULP180-0324	Screw Terminal @ O/P							
ULP180-0324	Header Molex @ I/P	24 V	4.68A	5.00A	7.50A	0.0 A	1%	PG & AC PF ¹¹
ULP180-0324	Header Molex @ O/P							
ULP180-0030	Header Molex @ I/P	30 V	3.75A	4.00A	6.00A	0.0 A	1%	PG & AC PF ¹¹
ULP180-0330	Screw Terminal @ O/P							
ULP180-0330	Header Molex @ I/P	30 V	3.75A	4.00A	6.00A	0.0 A	1%	PG & AC PF ¹¹
ULP180-0330	Header Molex @ O/P							
ULP180-0048	Header Molex @ I/P	48 V	2.34A	2.50A	3.75A	0.0 A	1%	PG & AC PF ¹¹
ULP180-0348	Screw Terminal @ O/P							
ULP180-0348	Header Molex @ I/P	48 V	2.34A	2.50A	3.75A	0.0 A	1%	PG & AC PF ¹¹
ULP180-0348	Header Molex @ O/P							
ULP180-0058	Header Molex @ I/P	58 V	1.94A	2.07A	3.10A	0.0 A	1%	PG & AC PF ¹¹
ULP180-0358	Screw Terminal @ O/P							
ULP180-0358	Header Molex @ I/P	58 V	1.94A	2.07A	3.10A	0.0 A	1%	PG & AC PF ¹¹
ULP180-0358	Header Molex @ O/P							
ULP180-CKP metal cover kit accessory								

Connectors		
J1	Pin 1	AC LINE
	Pin 2	NOT FITTED
	Pin 3	AC NEUTRAL
J2 Option 1 & 2	Pin 1,2,3	V1 +VE
	Pin 4,5,6	V1 -VE
J3	Pin 1	FAN +VE
	Pin 2	FAN -VE
J4 (For PGPF Option Only)	Pin 1	Vs
	Pin 2	PGPF
	Pin 3	GND

Notes

1. Ripple is peak to peak with 20 MHz bandwidth and 10 μ F (Electrolytic capacitor) in parallel with a 0.1 μ F capacitor at rated line voltage and load ranges.
2. For Class II version Enquire with EOS Sales Rep before Order.
3. Combined output power of main output, fan supply shall not exceed max. Power rating.
4. Fan supply output voltage tolerance including set point accuracy, line and load regulation is +/-10% and Ripple and noise is less than 10%.
5. Specifications are for nominal input voltage, 25°C unless otherwise stated.
6. 180W with 13CFM forced air cooling and 120W with natural convection cooling at 100 to 264VAC.
7. Output ripple can be more than 10% of the output voltage.
8. Fusing on neutral for ITE model is optional.
9. Adjustment potentiometer is located on the SMT side of the PCB.
10. When used in Cover Kit, de-rate output power to 70 % under all operating conditions
11. A TTL signal is available at pin 2 of J4 which goes high 100-500mS after output voltage reaches 90% of set value. It goes low a minimum of 1mS before output falls below 90% of the set value, when input AC is switched off.
12. Add suffix "S1" to get model number with Input connector – Screw terminal and Output Connector – Screw Terminal. e.g. ULP180-1012-S1.
13. Add suffix "S2" to get model number with Input connector – Right Angle Type and Output Connector – Right Angle Type. e.g. ULP180-1012-S2.

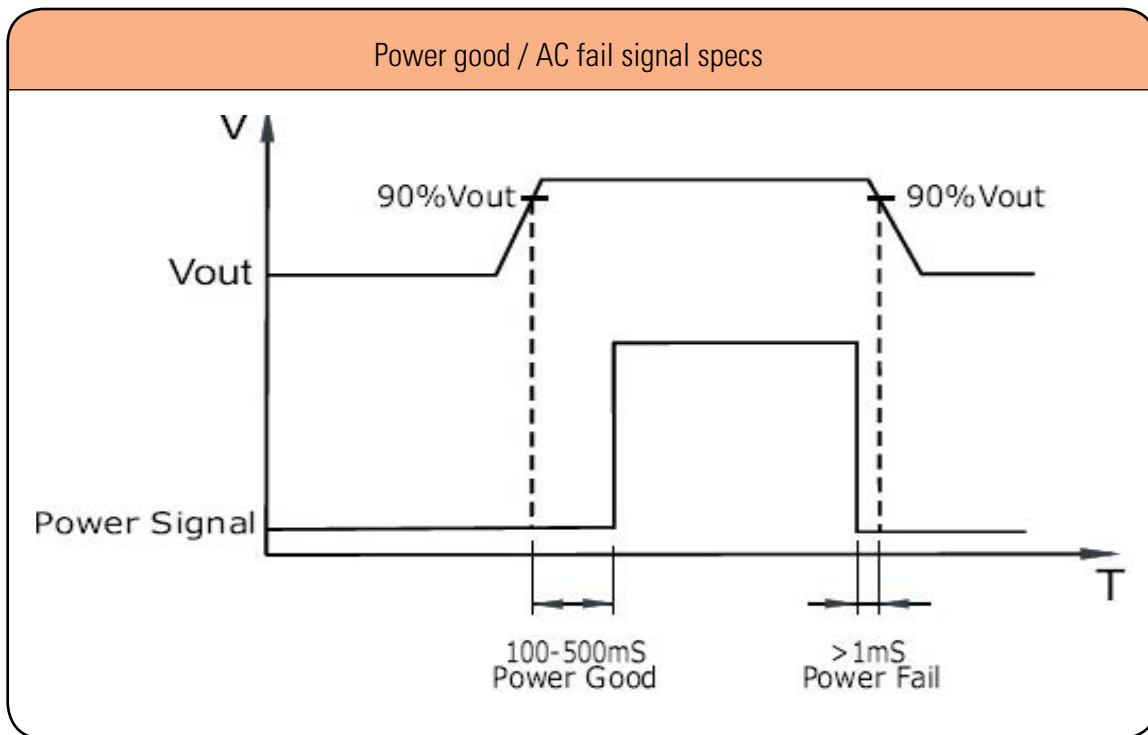

Mechanical Specifications

AC Input Connector (J1) Option 1 (Molex Connector @ I/P)	Molex: 26-60-4030 Mating: 09-50-3031; Pins: 08-50-0106
AC Input Connector (J1) Option 2 (Screw Terminal @ I/P)	Molex: 39357 Series or equivalent
DC Output Connector (J2) Option 1 (Molex Connector @ O/P)	Molex: 26-60-4060 Mating: 09-50-3061; Pins: 08-50-0106
DC Output Connector (J2) Option 2 (Screw Terminal @ O/P)	Molex: 39357 Series or equivalent
AC Input Connector (J1) Option 3 (Right Angle Type @ I/P)	TE Connectivity: 647676-3 Mating: 1-1123722-3 ; Crimp: 1123721-2
DC Output Connector (J2) Option 3 (Molex Connector @ O/P)	TE Connectivity: 647676-6 Mating: 1-1123722-6 ; Crimp: 1123721-2
Aux (Fan) Output(J3)	AMP :640456-2 Mating: 640440-2
Signal Output (J4)	AMP :640456-3 Mating: 640440-3
Dimensions	4 x 2 x 0.75 inches (101.60 x 50.8x 19.05 mm)
Weight	200 gm approx

EMC

Parameter	Conditions/Description	Criteria
Conducted Emissions	EN55032-B, CISPR22-B, FCC PART15-B	Pass
Radiated Emissions	EN 55032 A	Pass Level B with external core (King core K5B RC 25x12x15-M in input cable)
Input Current Harmonics	EN 61000-3-2	Class D
Voltage Fluctuation and Flicker	EN 61000-3-3	Pass
ESD Immunity	EN 61000-4-2	Level 3, Criterion A
Radiated Field Immunity	EN 61000-4-3	Level 3, Criterion A
Electrical Fast Transient Immunity	EN 61000-4-4	Level 3, Criterion A
Surge Immunity	EN 61000-4-5	Level 3, Criterion A
Conducted Immunity	EN 61000-4-6	Level 3, Criterion A
Magnetic Field Immunity	EN 61000-4-8	Level 3, Criterion A
Voltage dips, interruptions	EN 61000-4-11	Criterion A & B

Safety

CE Mark	Complies with LVD Directive
Approval Agency	Nemko, UL, C-UL
Safety Standard(s)	EN60950-1, IEC60950-1 (ed.2) , UL 60950 (ed.2), CSA C22.2 No.60950-1 (ed.2), Class1 SELV
Safety File Number(s)	UL: 20161121-E150565, Nemko: Certificate No: P16221546, CB Test Certificate No : NO94842



Innovations in Power

Derating Curve

Power de-rating

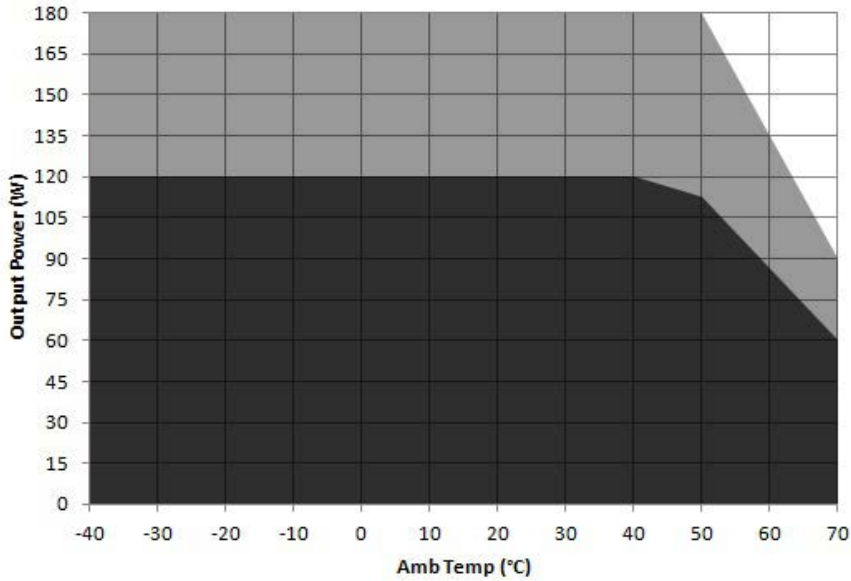

Convection load: 120W UP TO 40 °C
 De-rate between 40-50 °C @ 0.625% per °C
 De-rate above 50 °C @ 2.33% per °C

Forced air cooled load : 180W up to 50°C
 De-rate above 50 °C @ 2.5% per °C

Power de-rating : w.r.t. Input

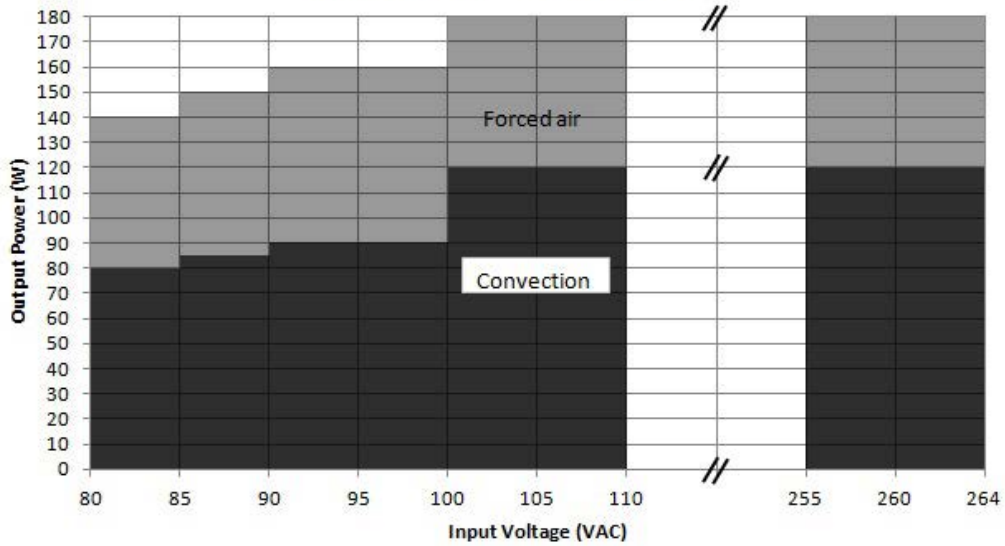

Mechanical Drawing

Input connector – Header Molex and Output Connector – Screw Terminal (Without PGPF)

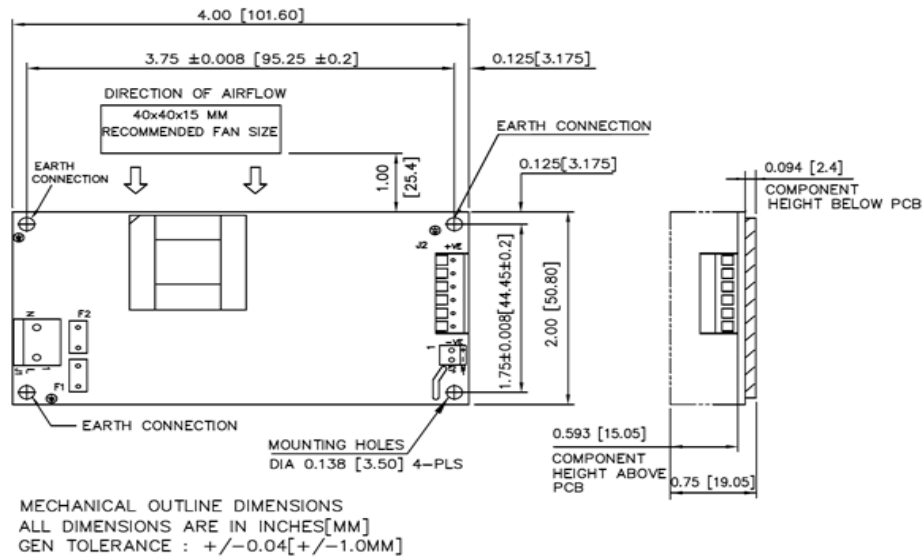

- Notes: In case the PCB is mounted in a metal enclosure, using metal hardware ensure the following
1. Stand off, used to mount PCB has OD of 5.4 mm max.
 2. Screws, used to fix PCB on stand off, have head dia of 6.0 mm max.
 3. Washer, if used, to have dia of 6.5 mm max.

Mechanical Drawing

Input connector – Header Molex and Output Connector – Screw Terminal. (With PGPF)

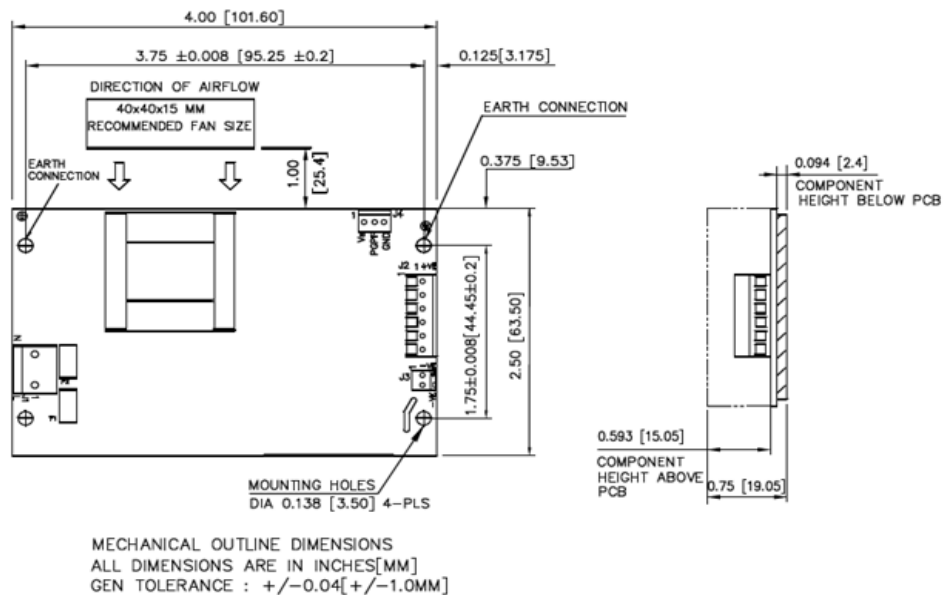

- Notes: In case the PCB is mounted in a metal enclosure, using metal hardware ensure the following
1. Stand off, used to mount PCB has OD of 5.4 mm max.
 2. Screws, used to fix PCB on stand off, have head dia of 6.0 mm max.
 3. Washer, if used, to have dia of 6.5 mm max.



Innovations in Power

Mechanical Drawing

Input connector – Header Molex and Output Connector – Header Molex. (Without PGPF)

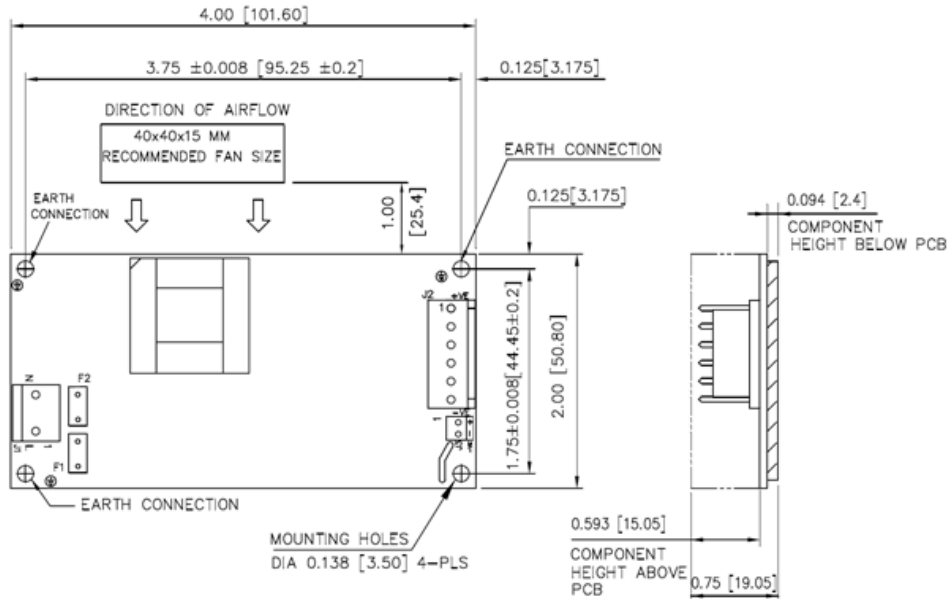

MECHANICAL OUTLINE DIMENSIONS
ALL DIMENSIONS ARE IN INCHES[MM]
GEN TOLERANCE : +/-0.04[+/-1.0MM]

Notes: In case the PCB is mounted in a metal enclosure, using metal hardware ensure the following

1. Stand off, used to mount PCB has OD of 5.4 mm max.
2. Screws, used to fix PCB on stand off, have head dia of 6.0 mm max.
3. Washer, if used, to have dia of 6.5 mm max.

Mechanical Drawing

Input connector – Header Molex and Output Connector – Header Molex. (With PGPF)

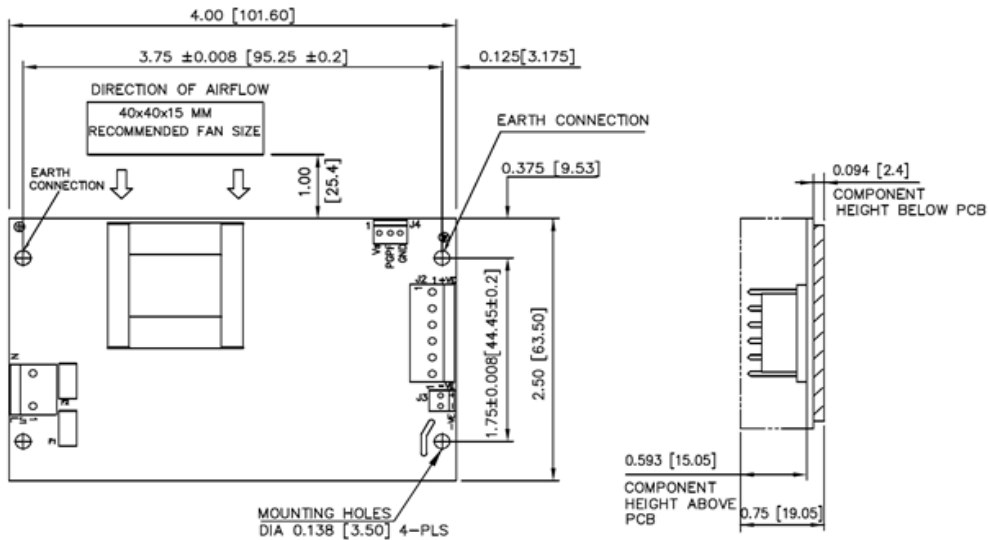

MECHANICAL OUTLINE DIMENSIONS
ALL DIMENSIONS ARE IN INCHES[MM]
GEN TOLERANCE : +/-0.04[+/-1.0MM]

Notes: In case the PCB is mounted in a metal enclosure, using metal hardware ensure the following

1. Stand off, used to mount PCB has OD of 5.4 mm max.
2. Screws, used to fix PCB on stand off, have head dia of 6.0 mm max.
3. Washer, if used, to have dia of 6.5 mm max.

Mechanical Drawing

Input connector – Screw terminal and Output Connector – Screw Terminal. (Without PGPF)

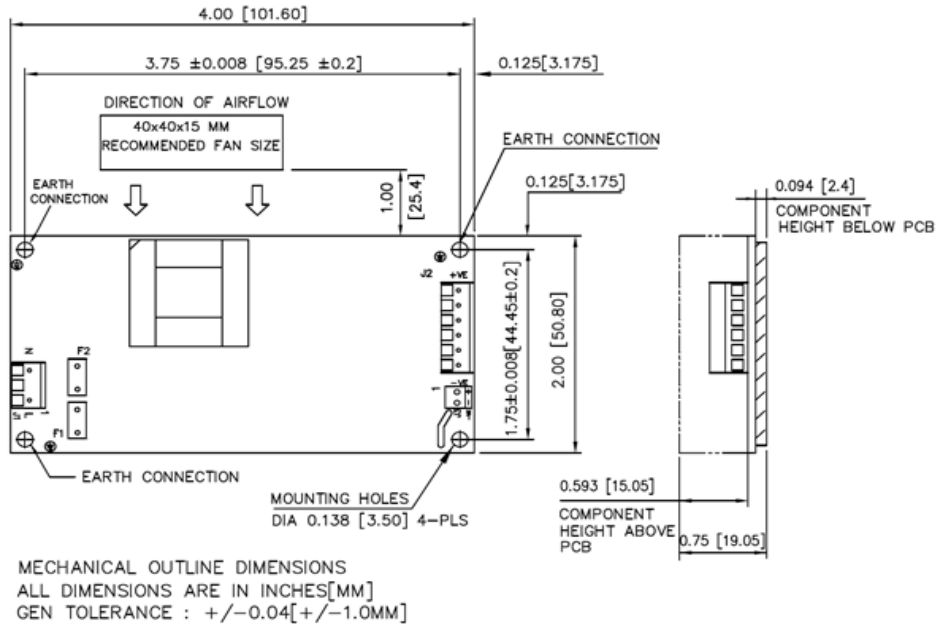

Notes: In case the PCB is mounted in a metal enclosure, using metal hardware ensure the following

1. Stand off, used to mount PCB has OD of 5.4 mm max.
2. Screws, used to fix PCB on stand off, have head dia of 6.0 mm max.
3. Washer, if used, to have dia of 6.5 mm max.

Mechanical Drawing

Input connector – Screw terminal and Output Connector – Screw Terminal. (With PGPF)

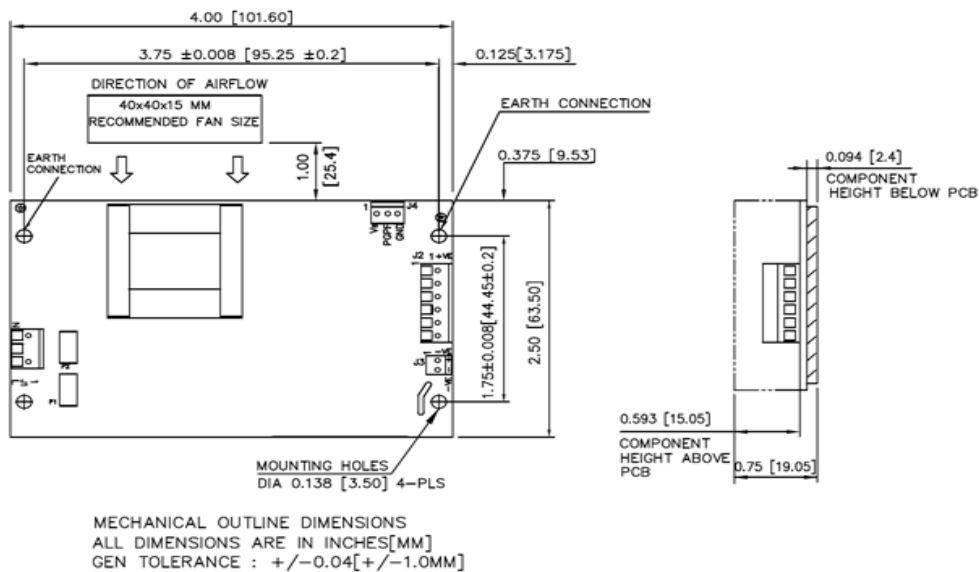

Notes: In case the PCB is mounted in a metal enclosure, using metal hardware ensure the following

1. Stand off, used to mount PCB has OD of 5.4 mm max.
2. Screws, used to fix PCB on stand off, have head dia of 6.0 mm max.
3. Washer, if used, to have dia of 6.5 mm max.



Innovations in Power

Mechanical Drawing

Input connector – Right Angle Type and Output Connector – Right Angle (Without PGPF)

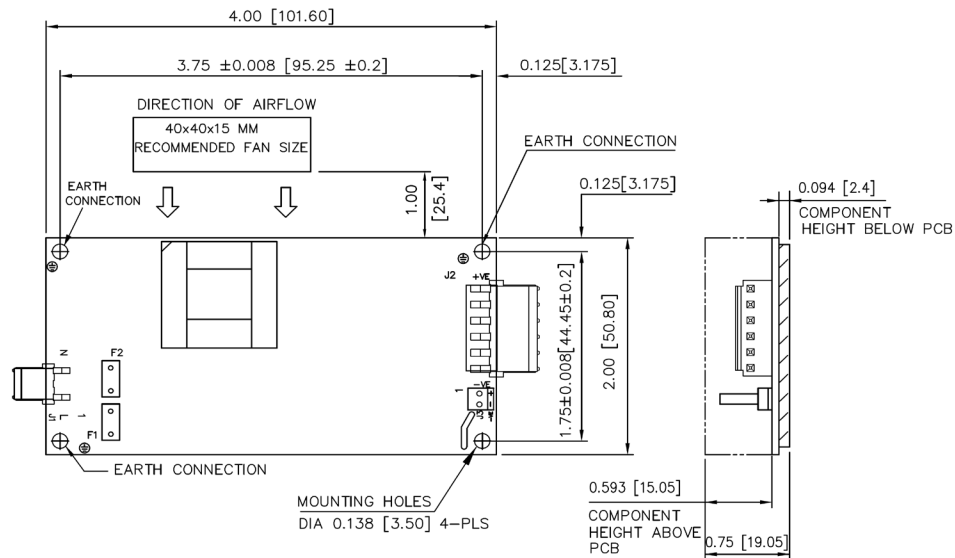

MECHANICAL OUTLINE DIMENSIONS
ALL DIMENSIONS ARE IN INCHES[MM]
GEN TOLERANCE : +/-0.04[+/-1.0MM]

MPN FOR INPUT CONNECTOR: 647676-3
MPN FOR OUTPUT CONNECTOR: 647676-6

Notes: In case the PCB is mounted in a metal enclosure, using metal hardware ensure the following

1. Stand off, used to mount PCB has OD of 5.4 mm max.
2. Screws, used to fix PCB on stand off, have head dia of 6.0 mm max.
3. Washer, if used, to have dia of 6.5 mm max.

Mechanical Drawing

Input connector – Right Angle Type and Output Connector – Right Angle (With PGPF)

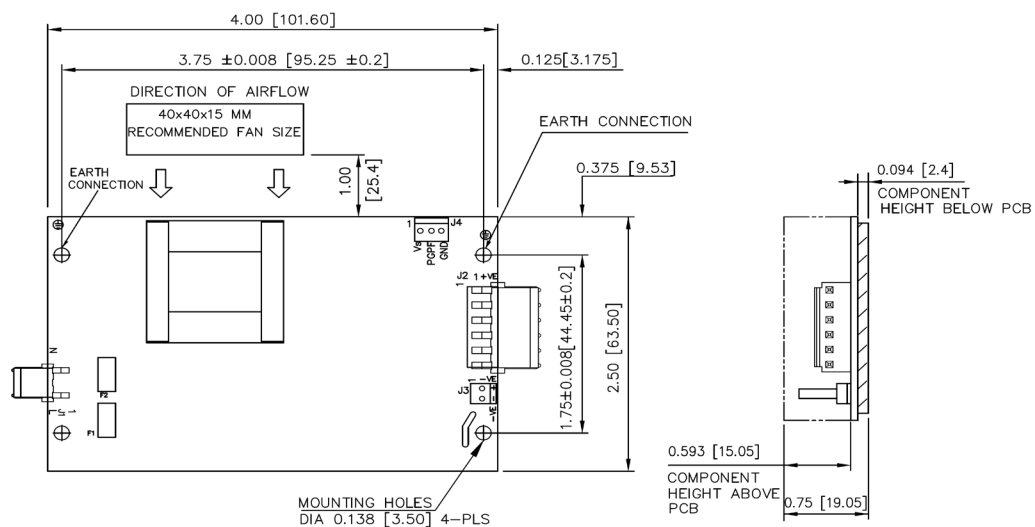

MECHANICAL OUTLINE DIMENSIONS
ALL DIMENSIONS ARE IN INCHES[MM]
GEN TOLERANCE : +/-0.04[+/-1.0MM]

MPN FOR INPUT CONNECTOR: 647676-3
MPN FOR OUTPUT CONNECTOR: 647676-6

Notes: In case the PCB is mounted in a metal enclosure, using metal hardware ensure the following

1. Stand off, used to mount PCB has OD of 5.4 mm max.
2. Screws, used to fix PCB on stand off, have head dia of 6.0 mm max.
3. Washer, if used, to have dia of 6.5 mm max.