

Model Number	Type of Connector	Voltage	Max. Load (Convection) (152W) @50°C	Max.Load (Convection) (160W) @40°C	Max. Load (13 CFM)	Min. Load	Ripple ¹	Signals
MULP275-1012	Header Molex @ I/P Screw Terminal @ O/P	12 V	12.50A	13.33A	22.92A	0.0 A	2%	N.A
MULP275-1312	Header Molex @ I/P Header Molex @ O/P	12 V	12.50A	13.33A	22.92A	0.0 A	2%	N.A
MULP275-1015	Header Molex @ I/P Screw Terminal @ O/P	15 V	10.00A	10.66A	18.33A	0.0 A	2%	N.A
MULP275-1315	Header Molex @ I/P Header Molex @ O/P	15 V	10.00A	10.66A	18.33A	0.0 A	2%	N.A
MULP275-1024	Header Molex @ I/P Screw Terminal @ O/P	24 V	6.25A	6.67A	11.46A	0.0 A	1%	N.A
MULP275-1324	Header Molex @ I/P Header Molex @ O/P	24 V	6.25A	6.67A	11.46A	0.0 A	1%	N.A
MULP275-1030	Header Molex @ I/P Screw Terminal @ O/P	30 V	5.00A	5.33A	9.17A	0.0 A	1%	N.A
MULP275-1330	Header Molex @ I/P Header Molex @ O/P	30 V	5.00A	5.33A	9.17A	0.0 A	1%	N.A
MULP275-1048	Header Molex @ I/P Screw Terminal @ O/P	48 V	3.12A	3.33A	5.73A	0.0 A	1%	N.A
MULP275-1348	Header Molex @ I/P Header Molex @ O/P	48 V	3.12A	3.33A	5.73A	0.0 A	1%	N.A
MULP275-1058	Header Molex @ I/P Screw Terminal @ O/P	58 V	2.58A	2.76A	4.74A	0.0 A	1%	N.A
MULP275-1358	Header Molex @ I/P Header Molex @ O/P	58 V	2.58A	2.76A	4.74A	0.0 A	1%	N.A
ULP275-CK metal cover kit accessory								



Innovations in Power

Model Number	Type of Connector	Voltage	Max. Load (Convection) (152W) @50°C	Max. Load (Convection) (160W) @40°C	Max. Load (13 CFM)	Min. Load	Ripple ¹	Signals
MULP275-0012	Header Molex @ I/P Screw Terminal @ O/P	12 V	12.50A	13.33A	22.92A	0.0 A	2%	PG & AC PF ¹⁰
MULP275-0312	Header Molex @ I/P Header Molex @ O/P	12 V	12.50A	13.33A	22.92A	0.0 A	2%	PG & AC PF ¹⁰
MULP275-0015	Header Molex @ I/P Screw Terminal @ O/P	15 V	10.00A	10.66A	18.33A	0.0 A	2%	PG & AC PF ¹⁰
MULP275-0315	Header Molex @ I/P Header Molex @ O/P	15 V	10.00A	10.66A	18.33A	0.0 A	2%	PG & AC PF ¹⁰
MULP275-0024	Header Molex @ I/P Screw Terminal @ O/P	24 V	6.25A	6.67A	11.46A	0.0 A	1%	PG & AC PF ¹⁰
MULP275-0324	Header Molex @ I/P Header Molex @ O/P	24 V	6.25A	6.67A	11.46A	0.0 A	1%	PG & AC PF ¹⁰
MULP275-0030	Header Molex @ I/P Screw Terminal @ O/P	30 V	5.00A	5.33A	9.17A	0.0 A	1%	PG & AC PF ¹⁰
MULP275-0330	Header Molex @ I/P Header Molex @ O/P	30 V	5.00A	5.33A	9.17A	0.0 A	1%	PG & AC PF ¹⁰
MULP275-0048	Header Molex @ I/P Screw Terminal @ O/P	48 V	3.12A	3.33A	5.73A	0.0 A	1%	PG & AC PF ¹⁰
MULP275-0348	Header Molex @ I/P Header Molex @ O/P	48 V	3.12A	3.33A	5.73A	0.0 A	1%	PG & AC PF ¹⁰
MULP275-0058	Header Molex @ I/P Screw Terminal @ O/P	58 V	2.58A	2.76A	4.74A	0.0 A	1%	PG & AC PF ¹⁰
MULP275-0358	Header Molex @ I/P Header Molex @ O/P	58 V	2.58A	2.76A	4.74A	0.0 A	1%	PG & AC PF ¹⁰
ULP275-CKP metal cover kit accessory								

Connectors		
J1	Pin 1	AC LINE
	Pin 2	NOT FITTED
	Pin 3	AC NEUTRAL
J2 Option 1 & 2	Pin 1,2,3	V1 +VE
	Pin 4,5,6	V1 -VE
J3	Pin 1	FAN +VE
	Pin 2	FAN -VE
J4 (For PGPF Option Only)	Pin 1	Vs
	Pin 2	PGPF
	Pin 3	GND

Notes

1. Ripple is peak to peak with 20 MHz bandwidth and 10 μ F (Electrolytic capacitor) in parallel with a 0.1 μ F capacitor at rated line voltage and load ranges.
2. Class II version available, Add "-II" suffix at the end of the Model Number.
3. Combined output power of main output, fan supply shall not exceed max. Power rating.
4. Fan supply output voltage tolerance including set point accuracy, line and load regulation is +/-10% and Ripple and noise is less than 10%.
5. Specifications are for nominal input voltage, 25°C unless otherwise stated.
6. 275W with 13CFM forced air cooling and 160W with natural convection cooling at 100 to 264VAC.
7. Output ripple can be more than 10% of the output voltage.
8. Adjustment potentiometer is located on the SMT side of the PCB.
9. When used in Cover Kit, de-rate output power to 70 % under all operating conditions
10. A TTL signal is available at pin 2 of J4 which goes high 100-500mS after output voltage reaches 90% of set value. It goes low a minimum of 1mS before output falls below 90% of the set value, when input AC is switched off.
11. Add suffix "S1" to get model number with Input connector – Screw terminal and Output Connector – Screw Terminal. e.g. MULP275-1012-S1.
12. Add suffix "S2" to get model number with Input connector – Right Angle Type and Output Connector – Right Angle Type. e.g. MULP275-1012-S2.

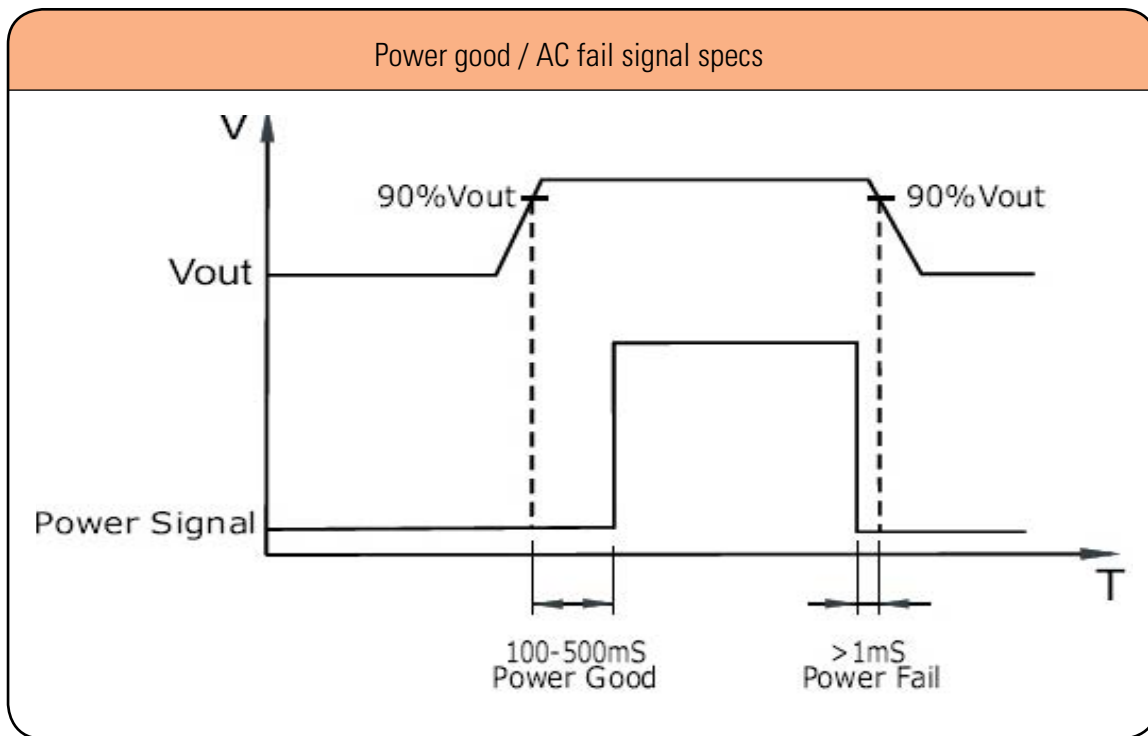

Mechanical Specifications

AC Input Connector (J1) Option 1 (Molex Connector @ I/P)	Molex: 26-60-4030 Mating: 09-50-3031; Pins: 08-50-0106
AC Input Connector (J1) Option 2 (Screw Terminal @ I/P)	Molex: 39357 Series or equivalent
DC Output Connector (J2) Option 1 (Molex Connector @ O/P)	Molex: 26-60-4060 Mating: 09-50-3061; Pins: 08-50-0106
DC Output Connector (J2) Option 2 (Screw Terminal @ O/P)	Molex: 39357 Series or equivalent
AC Input Connector (J1) Option 3 (Right Angle Type @ I/P)	TE Connectivity: 647676-3 Mating: 1-1123722-3 ; Crimp: 1123721-2
DC Output Connector (J2) Option 3 (Molex Connector @ O/P)	TE Connectivity: 647676-6 Mating: 1-1123722-6 ; Crimp: 1123721-2
Aux (Fan) Output(J3)	AMP :640456-2 Mating: 640440-2
Signal Ouput (J4)	AMP :640456-3 Mating: 640440-3
Dimensions	5 x 3 x 0.75 inches (127 x 76.2x 19.05 mm)
Weight	250 gm approx

EMC

Parameter	Conditions/Description	Criteria
Conducted Emissions	EN 55011-B,CISPR22-B, FCC PART15-B	Pass
Radiated Emissions	EN 55011 A	Pass (Level B with external core (King core K5B RC 25x12x15-M in input cable))
Input Current Harmonics	EN 61000-3-2	Class D
Voltage Fluctuation and Flicker	EN 61000-3-3	Pass
ESD Immunity	EN 61000-4-2	Level 4, Criterion A
Radiated Field Immunity	EN 61000-4-3	Level 3, Criterion A
Electrical Fast Transient Immunity	EN 61000-4-4	Level 3, Criterion A
Surge Immunity	EN 61000-4-5	Level 3, Criterion A
Conducted Immunity	EN 61000-4-6	Level 3, Criterion A
Magnetic Field Immunity	EN 61000-4-8	Level 4, Criterion A
Voltage dips, interruptions	EN 61000-4-11	Criterion B

Safety

CE Mark	Complies with LVD Directive
Approval Agency	Nemko, UL, C-UL
Safety Standard(s)	EN60601-1, IEC 60601-1 (ed.3), ANSI / AAMI ES 60601 - 1, CSA C22.2 No. 60601-1
Safety File Number(s)	Class-I : UL: E173812,VOL D1, Nemko: Certificate No: P16221541, CB Test Certificate No : NO94798 Class-II : UL: E173812,VOL D1, Nemko: Certificate No: P16221548, CB Test Certificate No: NO94849



Innovations in Power

Derating Curve

Power de-rating

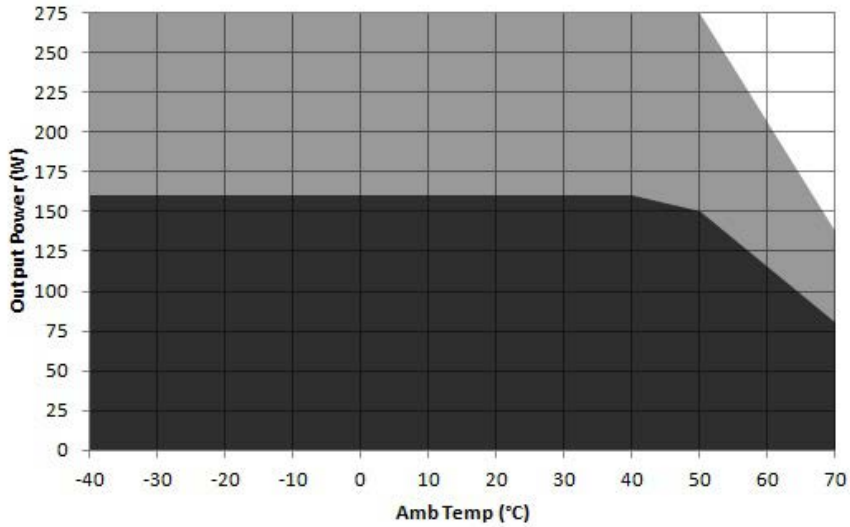

Convection load: 160W up to 40 °C
 De-rate between 40-50 °C @ 0.625% per °C
 De-rate above 50 °C @ 2.33% per °C
 Forced air cooled load : 275W up to 50°C
 De-rate above 50 °C @ 2.5% per °C

Power de-rating : w.r.t. Input

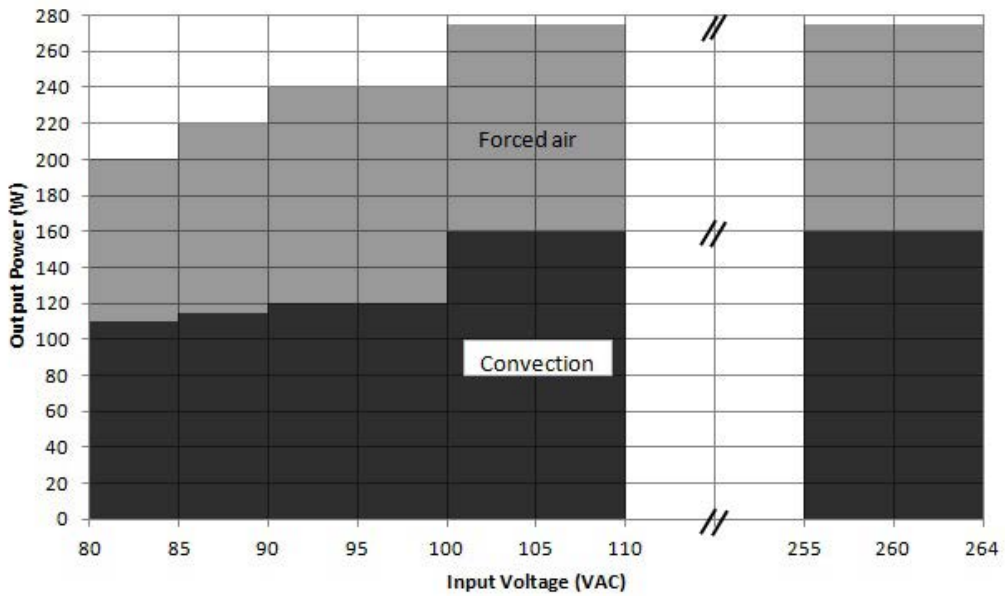

Mechanical Drawing

Input connector – Header Molex and Output Connector – Screw Terminal (Without PGPF)

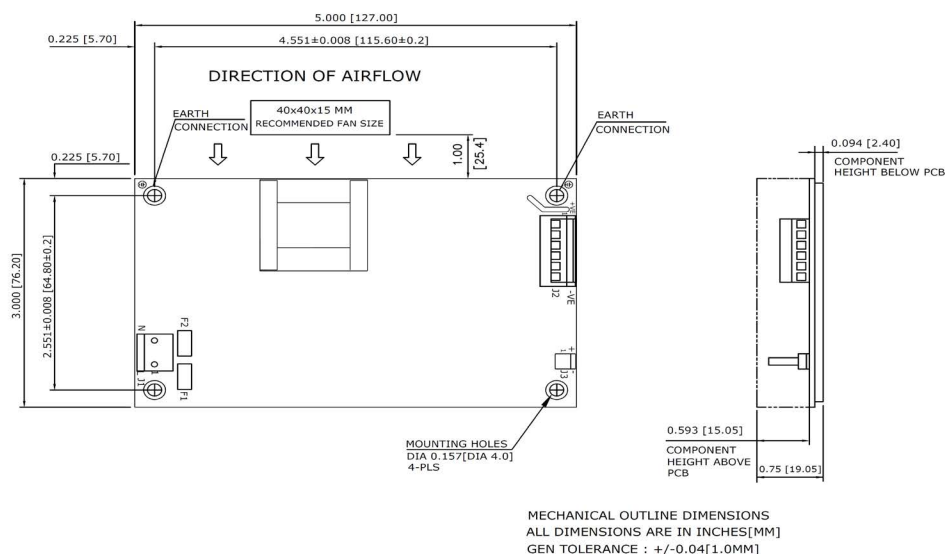

Notes: In case the PCB is mounted in a metal enclosure, using metal hardware ensure the following

1. Stand off, used to mount PCB has OD of 5.4 mm max.
2. Screws, used to fix PCB on stand off, have head dia of 6.0 mm max.
3. Washer, if used, to have dia of 6.5 mm max.

Mechanical Drawing

Input connector – Header Molex and Output Connector – Screw Terminal. (With PGPF)

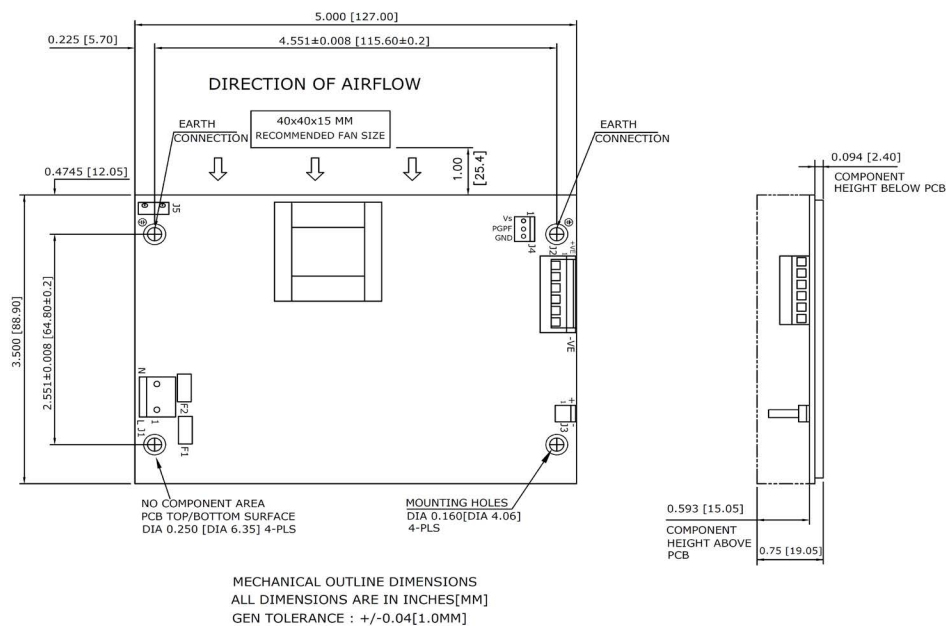

Notes: In case the PCB is mounted in a metal enclosure, using metal hardware ensure the following

1. Stand off, used to mount PCB has OD of 5.4 mm max.
2. Screws, used to fix PCB on stand off, have head dia of 6.0 mm max.
3. Washer, if used, to have dia of 6.5 mm max.



Innovations in Power

Mechanical Drawing

Input connector – Header Molex and Output Connector – Header Molex. (Without PGPF)

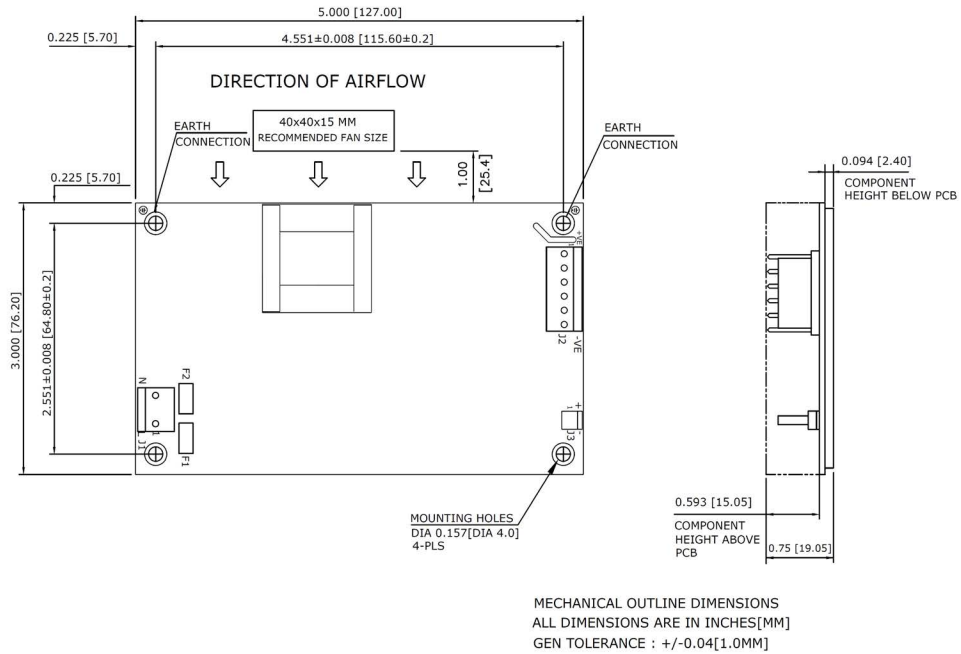

Notes: In case the PCB is mounted in a metal enclosure, using metal hardware ensure the following

1. Stand off, used to mount PCB has OD of 5.4 mm max.
2. Screws, used to fix PCB on stand off, have head dia of 6.0 mm max.
3. Washer, if used, to have dia of 6.5 mm max.

Mechanical Drawing

Input connector – Header Molex and Output Connector – Header Molex. (With PGPF)

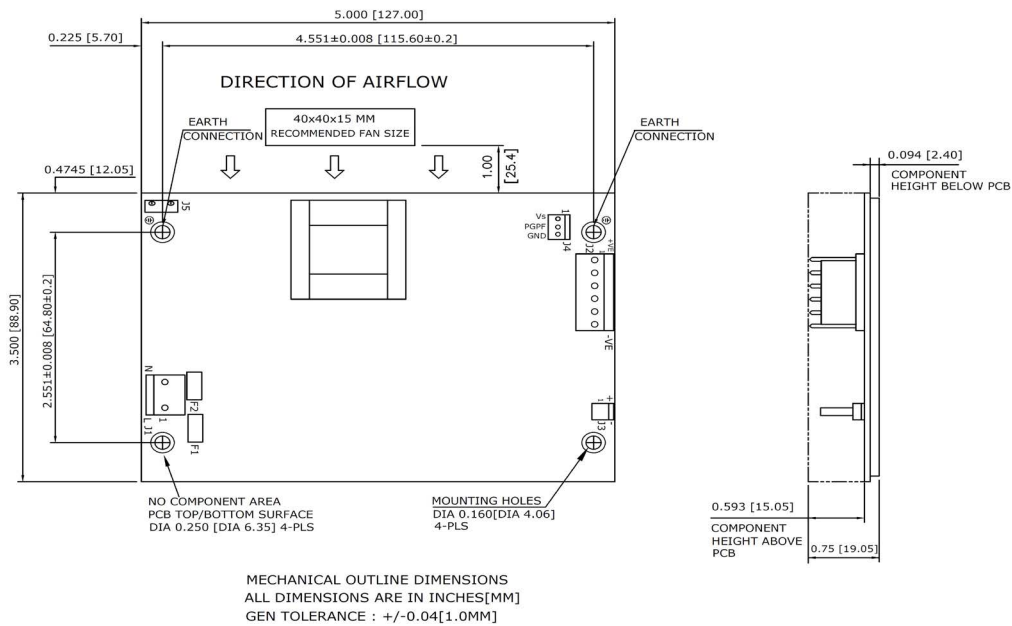

Notes: In case the PCB is mounted in a metal enclosure, using metal hardware ensure the following

1. Stand off, used to mount PCB has OD of 5.4 mm max.
2. Screws, used to fix PCB on stand off, have head dia of 6.0 mm max.
3. Washer, if used, to have dia of 6.5 mm max.

Mechanical Drawing

Input connector – Screw terminal and Output Connector – Screw Terminal. (Without PGPF)

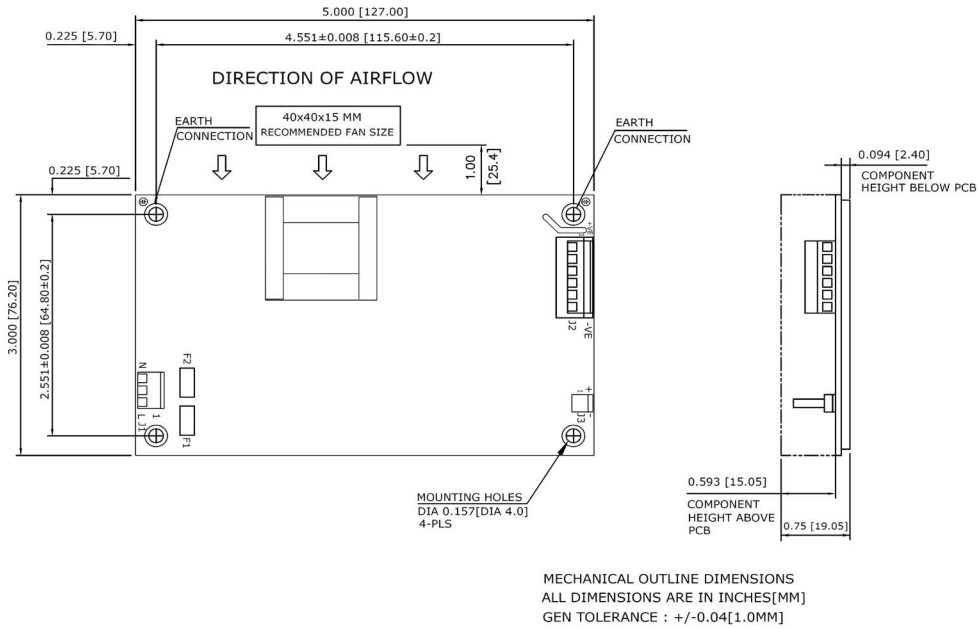

Notes: In case the PCB is mounted in a metal enclosure, using metal hardware ensure the following

1. Stand off, used to mount PCB has OD of 5.4 mm max.
2. Screws, used to fix PCB on stand off, have head dia of 6.0 mm max.
3. Washer, if used, to have dia of 6.5 mm max.

Mechanical Drawing

Input connector – Screw terminal and Output Connector – Screw Terminal. (With PGPF)

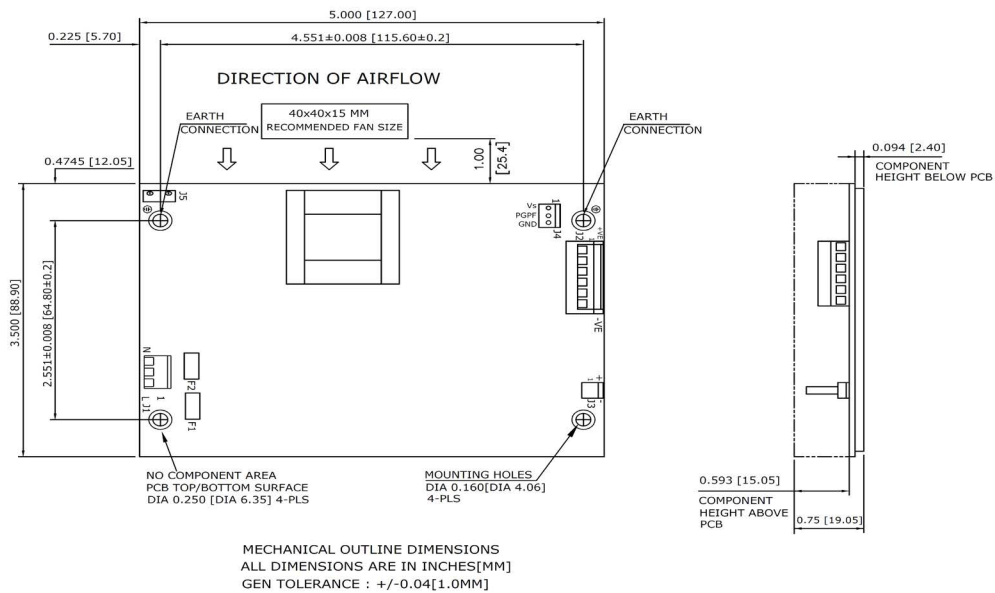

Notes: In case the PCB is mounted in a metal enclosure, using metal hardware ensure the following

1. Stand off, used to mount PCB has OD of 5.4 mm max.
2. Screws, used to fix PCB on stand off, have head dia of 6.0 mm max.
3. Washer, if used, to have dia of 6.5 mm max.



Innovations in Power

Mechanical Drawing

Input connector – Right Angle Type and Output Connector – Right Angle (Without PGPF)

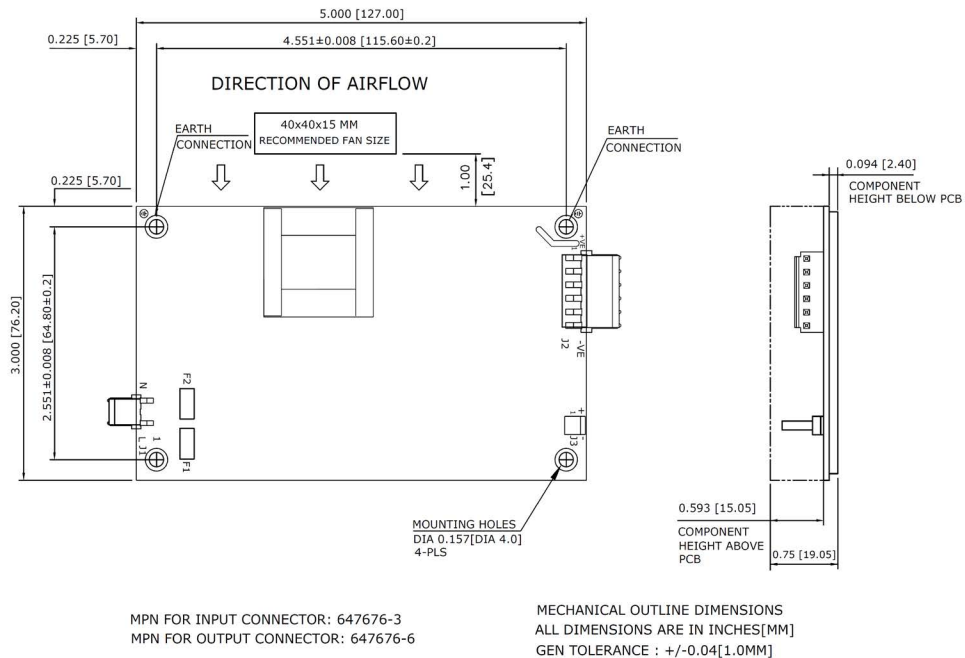

Notes: In case the PCB is mounted in a metal enclosure, using metal hardware ensure the following

1. Stand off, used to mount PCB has OD of 5.4 mm max.
2. Screws, used to fix PCB on stand off, have head dia of 6.0 mm max.
3. Washer, if used, to have dia of 6.5 mm max.

Mechanical Drawing

Input connector – Right Angle Type and Output Connector – Right Angle (With PGPF)

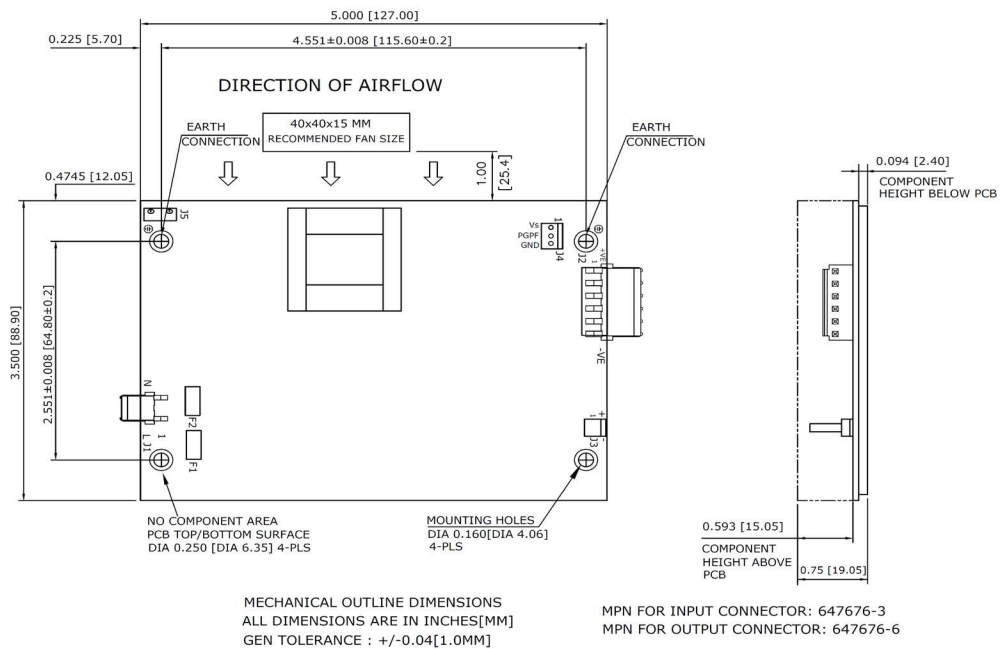

Notes: In case the PCB is mounted in a metal enclosure, using metal hardware ensure the following

1. Stand off, used to mount PCB has OD of 5.4 mm max.
2. Screws, used to fix PCB on stand off, have head dia of 6.0 mm max.
3. Washer, if used, to have dia of 6.5 mm max.