

Features

- Fast Switching Speed
- Surface Mount Package Ideally Suited for Automated Insertion
- High Reverse Breakdown Voltage
- Low Leakage Current
- **Totally Lead-Free & Fully RoHS Compliant (Notes 1 & 2)**
- **Halogen and Antimony Free. "Green" Device (Note 3)**
- **Qualified to AEC-Q101 Standards for High Reliability**
- **PPAP Capable (Note 4)**

Mechanical Data

- Case: SOT23
- Case Material: Molded Plastic. UL Flammability Classification Rating 94V-0
- Moisture Sensitivity: Level 1 per J-STD-020
- Terminals: Finish — Lead Free Plating (Matte Tin Finish Annealed over Alloy 42 Leadframe). Solderable per MIL-STD-202, Method 208 (E3)
- Polarity: See Diagrams Below
- Weight: 0.008 grams (Approximate)

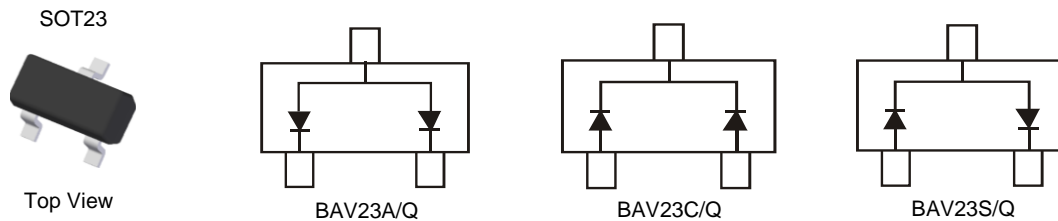

Ordering Information (Note 5)

Part Number	Qualification	Case	Packaging
BAV23A-7-F	Commercial	SOT23	3,000/Tape & Reel
BAV23A-13-F	Commercial	SOT23	10,000/Tape & Reel
BAV23AQ-7-F	Automotive	SOT23	3,000/Tape & Reel
BAV23AQ-13-F	Automotive	SOT23	10,000/Tape & Reel
BAV23C-7-F	Commercial	SOT23	3,000/Tape & Reel
BAV23C-13-F	Commercial	SOT23	10,000/Tape & Reel
BAV23CQ-7-F	Automotive	SOT23	3,000/Tape & Reel
BAV23CQ-13-F	Automotive	SOT23	10,000/Tape & Reel
BAV23S-7-F	Commercial	SOT23	3,000/Tape & Reel
BAV23S-13-F	Commercial	SOT23	10,000/Tape & Reel
BAV23SQ-13-F	Automotive	SOT23	10,000/Tape & Reel

- Notes:
1. No purposely added lead. Fully EU Directive 2002/95/EC (RoHS), 2011/65/EU (RoHS 2) & 2015/863/EU (RoHS 3) compliant.
 2. See <https://www.diodes.com/quality/lead-free/> for more information about Diodes Incorporated's definitions of Halogen- and Antimony-free, "Green" and Lead-free.
 3. Halogen- and Antimony-free "Green" products are defined as those which contain <900ppm bromine, <900ppm chlorine (<1500ppm total Br + Cl) and <1000ppm antimony compounds.
 4. Automotive products are AEC-Q101 qualified and are PPAP capable. Automotive, AEC-Q101 and standard products are electrically and thermally the same, except where specified. For more information, please refer to <https://www.diodes.com/quality/>.
 5. For packaging details, go to our website at <https://www.diodes.com/design/support/packaging/diodes-packaging/>.

Marking Information

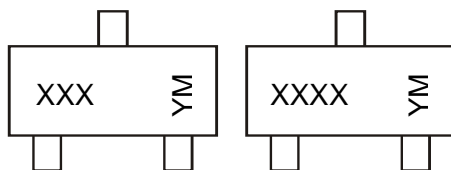

XXX or XXXX = Product Type Marking Code

ex. KT7 = BAV23A/Q

KT6 = BAV23C/Q

KL31 = BAV23S/Q

YM = Date Code Marking

Y = Year (ex: G = 2019)

M = Month (ex: 9 = September)

Date Code Key

Year	2003	2004	2005	2006	2018	2019	2020	2021	2022	2023	2024	2025
Code	P	R	S	T	F	G	H	I	J	K	L	M

Month	Jan	Feb	Mar	Apr	May	Jun	Jul	Aug	Sep	Oct	Nov	Dec
Code	1	2	3	4	5	6	7	8	9	O	N	D

Maximum Ratings (@T_A = +25°C, unless otherwise specified.)

Characteristic	Symbol	Value	Unit
Repetitive Peak Reverse Voltage	V _{R(RM)}	250	V
Working Peak Reverse Voltage	V _{R(WM)}	200	V
DC Blocking Voltage	V _R		
RMS Reverse Voltage	V _{R(RMS)}	141	V
Forward Continuous Current (Notes 6, 8)	I _{FM}	400	mA
Non-Repetitive Peak Forward Surge Current	I _{FSM}	@ t = 1.0μs	9.0
		@ t = 100μs	3.0
		@ t = 10ms	1.7
Repetitive Peak Forward Surge Current (Note 6)	I _{FRM}	625	mA

Thermal Characteristics

Characteristic	Symbol	Value	Unit
Power Dissipation (Note 6)	P _D	350	mW
Thermal Resistance Junction to Ambient Air (Note 6)	R _{θJA}	357	°C/W
Operating and Storage Temperature Range	T _J , T _{STG}	-65 to +150	°C

Electrical Characteristics (@T_A = +25°C, unless otherwise specified.)

Characteristic	Symbol	Min	Max	Unit	Test Condition
Reverse Breakdown Voltage (Note 7)	V _{(BR)R}	250	—	V	I _R = 100μA
Forward Voltage	V _F	—	1.0	V	I _F = 100mA
		—	1.25		I _F = 200mA
Reverse Current (Note 7)	I _R	—	100	nA	V _R = 200V, T _J = +25°C
		—	100	μA	V _R = 200V, T _J = +150°C
Total Capacitance	C _T	—	5.0	pF	V _R = 0, f = 1.0MHz
Reverse Recovery Time	t _{RR}	—	50	ns	I _F = I _R = 30mA, I _{RR} = 0.1 x I _R , R _L = 100Ω

Notes: 6. Part mounted on FR-4 board with recommended pad layout, which can be found on our website at <http://www.diodes.com/package-outlines.html>.
 7. Short duration pulse test used to minimize self-heating effect.
 8. Double Diode Loaded in Parallel. For Single Diode or Double Diode Loaded in Series, the continuous forward current should be reduced by half.

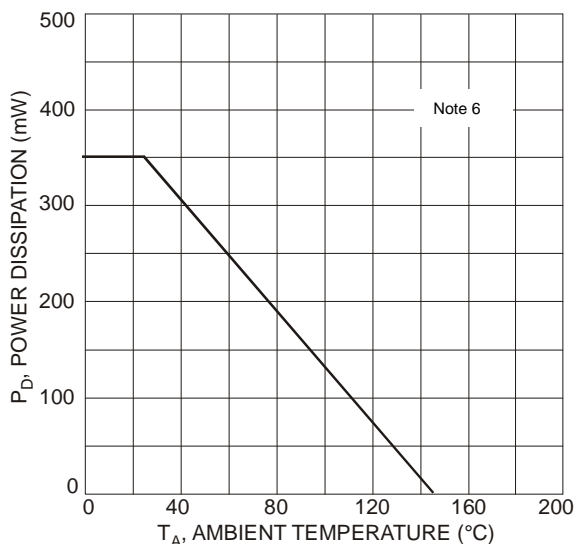

Fig. 1 Power Derating Curve, Total Package

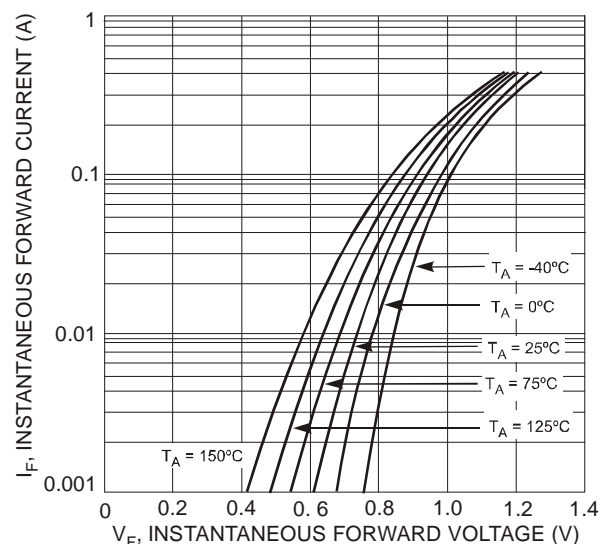

Fig. 2 Typical Forward Characteristics, Per Element

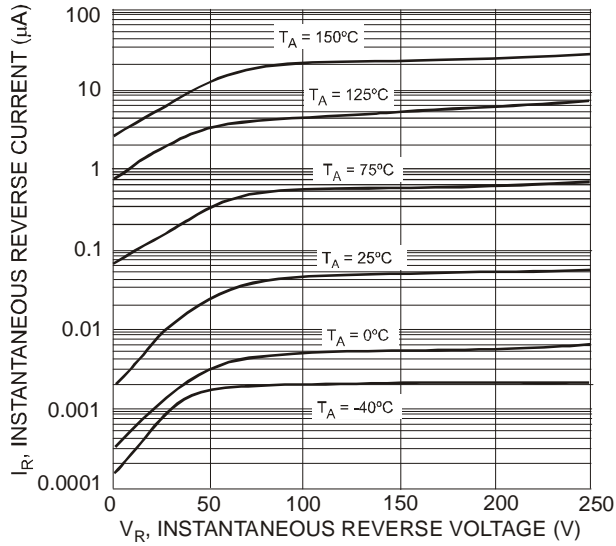

Fig. 3 Typical Reverse Characteristics, Per Element

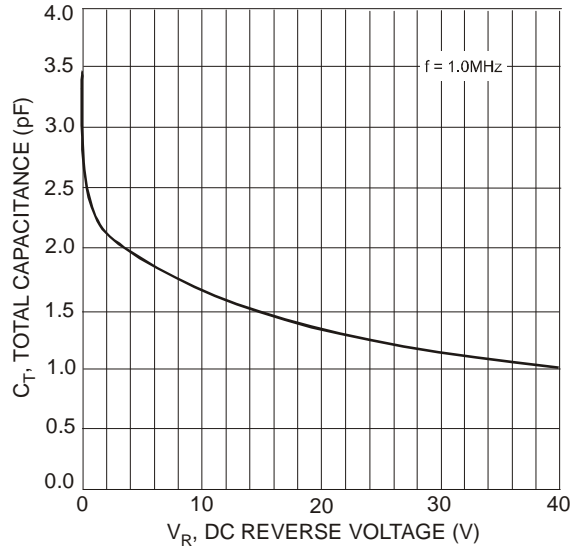
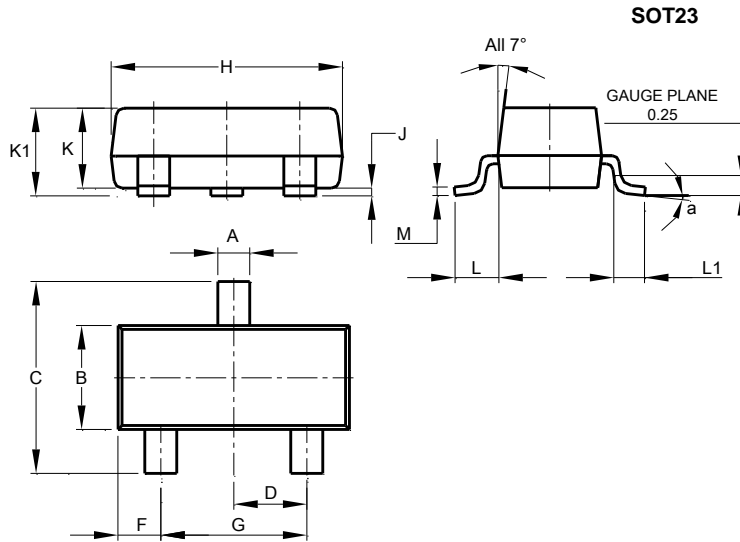

Fig. 4 Total Capacitance vs. Reverse Voltage, Per Element

Package Outline Dimensions

Please see <http://www.diodes.com/package-outlines.html> for the latest version.



SOT23			
Dim	Min	Max	Typ
A	0.37	0.51	0.40
B	1.20	1.40	1.30
C	2.30	2.50	2.40
D	0.89	1.03	0.915
F	0.45	0.60	0.535
G	1.78	2.05	1.83
H	2.80	3.00	2.90
J	0.013	0.10	0.05
K	0.890	1.00	0.975
K1	0.903	1.10	1.025
L	0.45	0.61	0.55
L1	0.25	0.55	0.40
M	0.085	0.150	0.110
a	0°	8°	--
All Dimensions in mm			

Suggested Pad Layout

Please see <http://www.diodes.com/package-outlines.html> for the latest version.

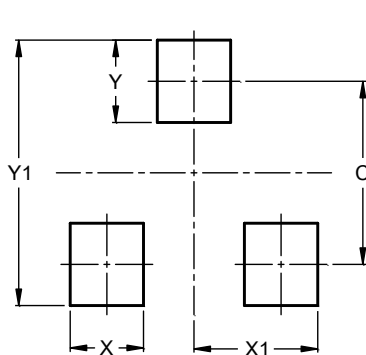

Dimensions	Value (in mm)
C	2.0
X	0.8
X1	1.35
Y	0.9
Y1	2.9

IMPORTANT NOTICE

DIODES INCORPORATED MAKES NO WARRANTY OF ANY KIND, EXPRESS OR IMPLIED, WITH REGARDS TO THIS DOCUMENT, INCLUDING, BUT NOT LIMITED TO, THE IMPLIED WARRANTIES OF MERCHANTABILITY AND FITNESS FOR A PARTICULAR PURPOSE (AND THEIR EQUIVALENTS UNDER THE LAWS OF ANY JURISDICTION).

Diodes Incorporated and its subsidiaries reserve the right to make modifications, enhancements, improvements, corrections or other changes without further notice to this document and any product described herein. Diodes Incorporated does not assume any liability arising out of the application or use of this document or any product described herein; neither does Diodes Incorporated convey any license under its patent or trademark rights, nor the rights of others. Any Customer or user of this document or products described herein in such applications shall assume all risks of such use and will agree to hold Diodes Incorporated and all the companies whose products are represented on Diodes Incorporated website, harmless against all damages.

Diodes Incorporated does not warrant or accept any liability whatsoever in respect of any products purchased through unauthorized sales channel. Should Customers purchase or use Diodes Incorporated products for any unintended or unauthorized application, Customers shall indemnify and hold Diodes Incorporated and its representatives harmless against all claims, damages, expenses, and attorney fees arising out of, directly or indirectly, any claim of personal injury or death associated with such unintended or unauthorized application.

Products described herein may be covered by one or more United States, international or foreign patents pending. Product names and markings noted herein may also be covered by one or more United States, international or foreign trademarks.

This document is written in English but may be translated into multiple languages for reference. Only the English version of this document is the final and determinative format released by Diodes Incorporated.

LIFE SUPPORT

Diodes Incorporated products are specifically not authorized for use as critical components in life support devices or systems without the express written approval of the Chief Executive Officer of Diodes Incorporated. As used herein:

A. Life support devices or systems are devices or systems which:

1. are intended to implant into the body, or
2. support or sustain life and whose failure to perform when properly used in accordance with instructions for use provided in the labeling can be reasonably expected to result in significant injury to the user.

B. A critical component is any component in a life support device or system whose failure to perform can be reasonably expected to cause the failure of the life support device or to affect its safety or effectiveness.

Customers represent that they have all necessary expertise in the safety and regulatory ramifications of their life support devices or systems, and acknowledge and agree that they are solely responsible for all legal, regulatory and safety-related requirements concerning their products and any use of Diodes Incorporated products in such safety-critical, life support devices or systems, notwithstanding any devices- or systems-related information or support that may be provided by Diodes Incorporated. Further, Customers must fully indemnify Diodes Incorporated and its representatives against any damages arising out of the use of Diodes Incorporated products in such safety-critical, life support devices or systems.

Copyright © 2019, Diodes Incorporated

www.diodes.com