

Miniature Quartz Crystal

HC-49, Low Profile, SMD

Technical Data

49SMLB / SAB / SUB / SNC

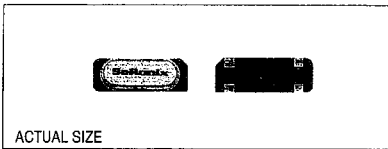

Description

The crystals are miniature AT or BT cut strip resonators housed in low profile packages for surface mounting. The parts present a proven metal package technology with a precision molded base and universal contact configuration.

Applications & Features

- Low profile SMD
- AT or BT cut performance
- Resistance weld seal
- 49SNC is interchangeable with popular molded crystal configurations
- Available on tape & reel; 24mm tape, 1000pcs per reel

Solder Reflow Guide

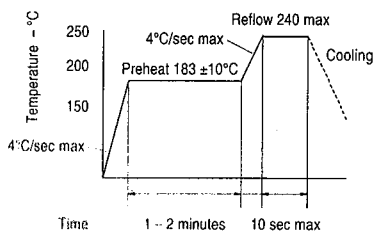

Lead Configurations



Frequency Range: 3.2 MHz to 80 MHz
 3.2 to 29.999 MHz, AT Fundamental
 26.8 to 50.000 MHz, BT Fundamental
 30.0 to 80.000 MHz, AT 3rd OT

Temperature Range:
 Operating: -20 to +70°C (-40 to +85°C available)
 Storage: -55 to +125°C

Frequency Stability Tolerance: ±50 ppm -20 to +70°C (0 to -100 ppm for BT)

Characteristics at 25°C ±2°C:
 Frequency Calibration Tolerance: ±50 ppm (tighter available)
 Load Capacitance: 16 pF to 32 pF or series resonance
 Effective Series Resistance: 30 to 200Ω (frequency dependent)
 Drive Level: 25μW correlation, 500μW max
 Shunt Capacitance: 7 pF max

Mechanical:

Shock: MIL-STD-883, Method 2002, Condition B
 Solderability: MIL-STD-883, Method 2003
 Terminal Strength: MIL-STD-202, Method 211, Conditions A and C
 Vibration: MIL-STD-883, Method 2007, Condition A
 Solvent Resistance: MIL-STD-202, Method 215
 Resistance to Soldering Heat: MIL-STD-202, Method 210, Condition I or J

Environmental:

Gross Leak Test: MIL-STD-883, Method 1014, Condition C
 Fine Leak Test: MIL-STD-883, Method 1014, Condition A
 Thermal Shock: MIL-STD-883, Method 1011, Condition A
 Moisture Resistance: MIL-STD-883, Method 1004

Part Numbering Guide:

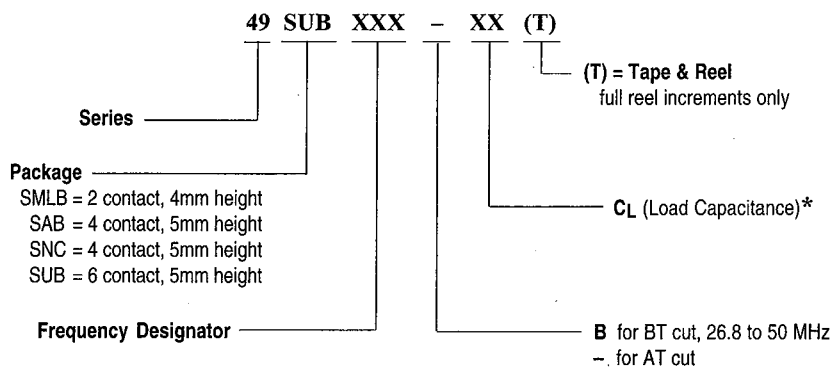

*If no CL value is specified, crystal is calibrated for series resonance.
 Example: 49SAB120 (Part marked: S120)

If CL value is specified, crystal is calibrated for parallel resonance.
 Example: 49SUB073-20 (Part marked: S073-20)

SaRonix

Miniature Quartz Crystal

HC-49, Low Profile, SMD

Technical Data

49SMLB / SAB / SUB / SNC

Package Details

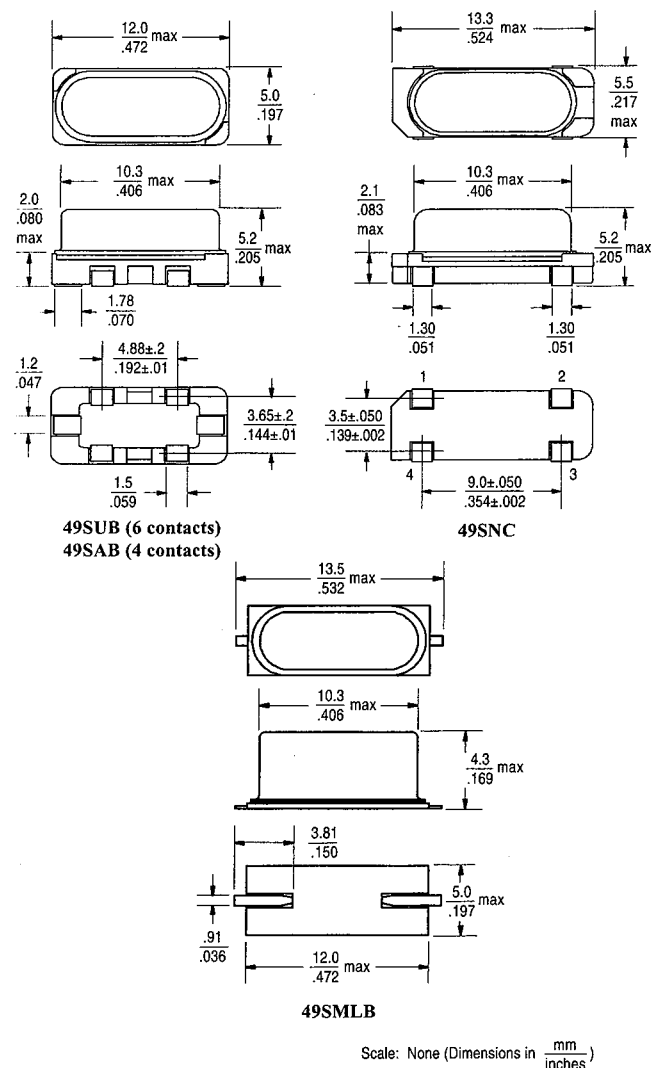

Recommended Land Patterns

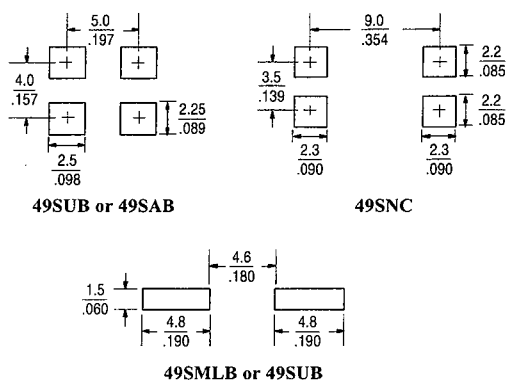

Common Frequencies:

The following selection chart lists series of crystals considered standard. Special frequencies and load calibrations are available upon request.

Frequency MHz	SaRonix Part Number	Max ESR (Fund)	SaRonix Part Number	Max ESR (3rd OT)
3.579545	49xxx035-18	200		
3.686400	49xxx037	160		
3.686400	49xxx037-20	160		
4.000000	49xxx040	150		
4.915200	49xxx049	150		
5.068800	49xxx051	120		
6.000000	49xxx060	100		
7.372800	49xxx073-20	80		
8.000000	49xxx080	80		
10.000000	49xxx100	60		
11.059200	49xxx111-20	60		
12.000000	49xxx120	60		
12.288000	49xxx122-20	60		
14.318180	49xxx143-32	30		
15.000000	49xxx150	30		
16.000000	49xxx160	30		
16.000000	49xxx160-20	30		
18.000000	49xxx180-20	30		
18.432000	49xxx184	30		
19.660800	49xxx196-20	30		
20.000000	49xxx200-20	30		
20.000000	49xxx200-50	30		
24.000000	49xxx240	30		
24.000000	49xxx240-16	30		
24.000000	49xxx240-20	30		
24.576000	49xxx245	30		
24.576000	49xxx245-16	30		
25.000000	49xxx250	30		
25.000000	49xxx250-16	30		
26.800000	49xxx268B	30		
26.800000	49xxx268B16	30		
28.000000	49xxx280B	30		
28.000000	49xxx280B16	30		
29.491200	49xxx294B	30		
29.491200	49xxx294B16	30		
30.000000	49xxx300B	30	49xxx300	80
30.000000	49xxx300B16	30	49xxx300-16	80
32.000000	49xxx320B	30	49xxx320	80
32.000000	49xxx320B16	30	49xxx320-16	80
32.256000	49xxx322B	30	49xxx322	80
32.256000	49xxx322B22	30	49xxx322-22	80
33.000000	49xxx330B	30		
33.333000	49xxx333B	30		
33.868000	49xxx338B	30		
35.251200	49xxx352B	30	49xxx352	80
35.251200	49xxx352B18	30	49xxx352-18	80
36.000000	49xxx360B	30	49xxx360	80
36.000000	49xxx360B22	30	49xxx360-22	80
40.000000	49xxx400B	30	49xxx400	80
40.000000	49xxx400B16	30	49xxx400-16	80
40.320000	49xxx403B	30	49xxx403	80
40.960000			49xxx409	80
42.000000	49xxx420B	30	49xxx420	80
42.000000	49xxx420B16	30	49xxx420-16	80
42.500000			49xxx425	80
45.000000	49xxx450B	30	49xxx450	80
45.000000	49xxx450B16	30	49xxx450-16	80
46.000000	49xxx460B	30	49xxx460	80
46.000000	49xxx460B16	30	49xxx460-16	80
48.000000			49xxx480	80
48.000000			49xxx480-16	80
50.000000	49xxx500B	30	49xxx500	80
50.000000	49xxx500B16	30	49xxx500-16	80
52.416000			49xxx524	80
56.448000			49xxx564	80
60.000000			49xxx600	80
60.000000			49xxx600-16	80
66.666667			49xxx666	80
66.666667			49xxx666-16	80

All specifications are subject to change without notice.

DS-153 REV E

Crystals: SMD

Rev. F.

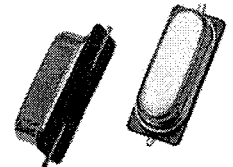

Actual Size



Product Description

The crystals are miniature AT or BT cut strip resonators housed in low profile packages for surface mounting. The parts utilize a proven, low-cost, metal package technology with a precision molded base and universal contact configuration.

Product Features

- 49SNC is interchangeable with common plastic-molded crystal configurations.
- Pb-free and RoHS/Green compliant available.

Typical Applications

- Set-Top Box/Multimedia
- Clock/VCXO Multiplier
- Network Adapter Cards
- Modems
- Microcontrollers and Processors
- Remote control devices

Frequency Range:

- 3.2 to 29.999 MHz, AT Fundamental
- 30.0 to 54.000 MHz, AT 3rd OT
- 26.8 to 54.000 MHz, BT Fundamental

Characteristics at 25°C ±2°C:

- Frequency Calibration Tolerance (as specified): ±30ppm, ±50ppm
- Load Capacitance (as specified): 12 to 32pF or Series Resonance
- Effective Series Resistance:
 - 200Ω max (3.2 to 3.499MHz)
 - 180Ω max (3.5 to 3.999MHz)
 - 150Ω max (4 to 4.999MHz)
 - 120Ω max (5 to 5.999MHz)
 - 100Ω max (6 to 6.999MHz)
 - 80Ω max (7 to 8.999MHz)
 - 60Ω max (9 to 12.999MHz)
 - 40Ω max (13 to 19.999MHz)
 - 30Ω max (20 to 29.999MHz, AT Fund)
 - 80Ω max (30 to 54MHz, AT (3rd overtone)
 - 30Ω max (26.8 to 54MHz, BT Fund)
- Drive Level: 100μW correlation, (500μW Max)
- Shunt Capacitance: 7pF Max.

Temperature Range:

- Operating: -20 to +70°C ; -40 to +85°C (as specified)
- Storage: -55 to +125°C

Temperature Stability (as specified):

- ±30ppm (-20 to +70°C) AT Cut
- ±50 or ±100ppm (-40 to +85°C) AT Cut
- 0 to -100ppm (-20 to +70°C) BT Cut

Aging @ 25°C, first year:

- ±3ppm (typ), ±5ppm (max)

Reflow Temperature:

- 240°C Max (non-RoHS package)
- 260°C Max, 10 sec max (RoHS package)

Packaging Information: HC-49

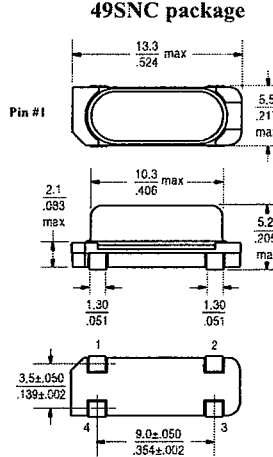
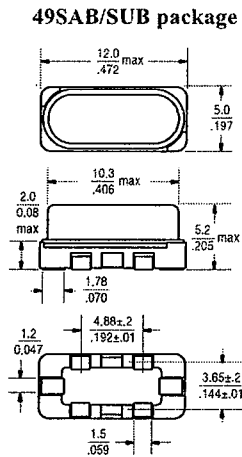
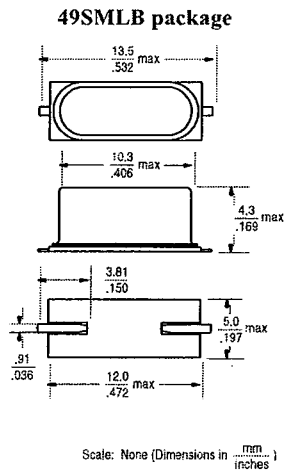

Package Marking Information

Line 1: S = SaRonix
xxx = Calib/Stability/Temp Code
YYWWX = Date Code
Line 2: Frequency (up to 7 digits, including decimal point)
Z = - (dash) for AT-cut parallel resonant
= blank for AT-cut series resonant
= B for BT-cut
xx = Load Capacitance (leave Blank if Series)

SxxxYYWWX
24.5760zxx

Land Pattern

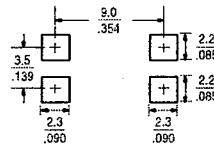
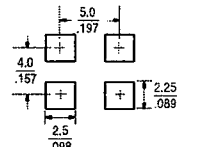
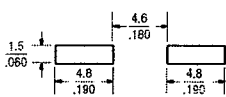

Pad Connection Configurations

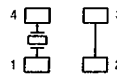
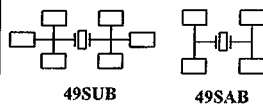
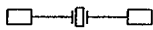

Ordering Information

49SMLB 03.6864 = 18 GGC -E (X)

Type / Package
49SMLB = 2 contact, 4mm high
49SAB = 4 contact, 5 mm high
49SNC = 4 contact, 5mm high
49SUB = 6 contact, 5mm high

Frequency
Frequency (in MHz) = 0x.xxxx, xx.xxxx
(a zero is used in front of frequencies under 10 MHz)

Cut Type
- (dash) = AT-cut Parallel Resonance
Blank = AT-cut Series Resonance
B = BT-Cut

Load Capacitance
xx = Parallel Resonance (specify load)
Blank = Series Resonance

Options
(T) = Tape and Reel (full increments only) 1000 pieces
(Q) = Manufactured in a TS16949 or QS9000 registered facility
Blank = Bulk

-E (dash E) = Lead (Pb)-free RoHS Compliant Version
Blank = non-RoHS (not available for new designs)

Calibration / Stability / Temp Range
GGC = ±30ppm / ±30ppm / -20 to +70°C (ATCut) ←
GHE = ±30ppm / ±50ppm / -40 to +85°C (ATCut)
HJE = ±50ppm / ±100ppm / -40 to +85°C (ATCut)
Blank = ±50ppm/0 to -100ppm/-20 to +70°C (BTCut)
*others available

Part Number Examples: Freq 5.1234MHz, ±30ppm calib, ±30ppm stability, -20 to +70°C, 16pF
= 49SMLB05.1234-16GGC
= 49SMLB05.1234-16GGC-E (for Pb-Free/RoHS Compliant)

Mechanical:

- Shock: JESD22-B104 Condition B
- Solderability: MIL-STD-883, Method 2003 (non-RoHS package)
- Solderability: J-STD-002(RoHS package)
- Terminal Strength: MIL-STD-883 Method 2004
- Vibration: JESD22-B103
- Solvent Resistance: JESD22-B107
- Resistance to Soldering Heat: MIL-STD-202, Method 210, Condition I or J (Non-RoHS package)
- Resistance to Soldering Heat: J-STD-020C Table 5-2 Pb-free devices (3 cycles max) (RoHS package)

Environmental:

- Gross Test Leak: JESD22-A109, Condition C
- Fine Test Leak: JESD22-A109, Condition A1
- Moisture Resistance: JESD22-A113
- Insulation Resistance: 500 MΩ min (100 VDC)