



Automation for a Changing World

Delta Human Machine Interface DOP-100 Series



www.deltaww.com

 **DELTA**
Smarter. Greener. Together.

Advanced Human Machine Interface for

The DOP-100 Series Human Machine Interfaces include a Basic HMI, Standard HMI and Advanced HMI for different applications. The HMIs adopt the latest Cortex-A8 / Dual Core high-speed processor and 65,536 color LCD screen with high brightness and contrast. In addition, they are equipped with the HMI programming software DOPSoft 4.0 and built-in Lua editor for easy programming as well as alarm / history log / user authority functions for highly efficient management.

With advanced communication capabilities and enhanced functions, the DOP-100 Series elevates machine efficiency to bring more value to our customers, and to achieve "Automation for a Changing World"!



Standard HMI

Features General and Ethernet Types for various applications

Future Industry

Advanced HMI

Features narrow frame design, supports various network communications, multilingual input and multimedia functions

Basic HMI

Simple operating structure for harsh environments

Table of Contents

Introduction	2
Model Selection	
Advanced HMI	
Standard HMI	
Basic HMI	
Robust Hardware	14
Power Isolation	
Fully Isolated Communication Interface	
PCB Coating	
Programming Software – DOPSoft 4.0	15
Abundant Elements	
Smooth Animation	
User-Friendly Programming Interface	
Editing Windows	
Advanced Alarm	20
Alarm Functions	
Data Management	22
Historical Data	
Historical Data Review	
Zoom In / Out Display	
Recipes	
PDF for Data Review	
User Authority Management	24
Account and Authorization Management	
Operation Log	
Cloud Integration	25
FTP Server	
VNC Server	
Web Monitoring	
Product Information	26
Hardware Specifications	
Model Description	
Dimensions	
Global Operations	34

Easy Model Selection

The DOP-100 Series offers complete models for different applications. Users can easily select a suitable HMI based on size or function easily

- B**
Type 1 COM port
- D**
Type 1 COM port + 1 Ethernet port
- C**
Type 2 COM ports
- E**
Type 2 COM ports + 1 Ethernet port
- I**
Type 3 COM ports + 1 Ethernet port
- W**
Type More than 1 COM port + 1 Ethernet port + Narrow frame design + Multi-language
- M**
Type 2 COM ports + 2 Ethernet ports + Narrow frame design + Multi-language + Multi-media

Type Definition

DOP-107 W V



Advanced HMI
At least 1 COM Ports &
1 Ethernet prot included



Advanced Narrow Frame



Advanced Multimedia

Standard HMI
At least 2 COM Ports
included



Standard General



Standard Ethernet
(2COM)

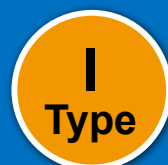

Standard Ethernet
(3COM)

Basic HMI
1 COM Ports included



Basic



Basic Ethernet

Advanced HMI

The Advanced HMI adopts a wide screen and narrow frame design. It supports Ethernet communication & multilingual inputs. The Multimedia Type DOP-112 / 115 offers multimedia functions to meet different applications.



Features

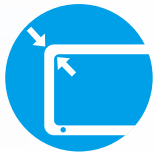

Narrow Frame
Enlarged visual display for better user experience



LUA Language
Simple and easy structural programming language to meet various demands



Pressing times >10,000,000
Effective pressing times increased through strict endurance tests



IP65 Rating
The front case protects the HMI from snow, rain, and dust



Multilingual Input
16 different languages input for easy operation



Diagnostics Function
Collects and solves issues remotely



Power Isolation
Protects the HMI from accidental surge interference



VNC Remote Monitoring
Remote control with mobile devices



QRcode Scanning
Generates QRcodes with self-defined content for mobile device identification



Supports GIF Graphic Elements
Easy setting to play vivid GIF elements



Embedded Linux System
Open system for flexible and stable program development



DOPSoft 4.0
New software DOPSoft 4.0 offers more complete functions and a better interface



Operating Temperature 0°C ~ 50°C
Compliant with industrial operating environments



CE / UL Certified
Compliant with CE and UL standards



Multimedia Functions
Captures image with an external camera or replays important recordings



Ethernet Communication
Connects to a master device or PLC with high-speed Ethernet communication



Communication Isolation
COM and Ethernet ports with built-in isolation circuits enhance communication stability



FTP/eMail Supported
Simple data transmission and real-time status report



Supports PDF and TXT Reader
PDF and TXT files supported



User-Friendly
Intuitive operation interfaces for users

Camera & Video Play Multi-Media Functions



Analog Camera

Supports external camera via analog, suitable for capturing fast and short-distanced images

Applications: Textiles | Pharmaceutical | Rubber & Plastics



IP Camera

Supports IP Camera via Ethernet, suitable for capturing remote and wide-range images

Applications: Packaging | Logistics | Mining | Power Generation | Oil & Gas



VGA Input

Displays images from external devices such as machine vision systems, PCs or notebooks



Video Play

Views mpeg4 files captured by analog or IP camera from internal storage or USB disk/SD card



Event Trigger

HMI performs specific actions when an event condition occurs
Sets up event trigger conditions to capture images and archive as mpeg4 files



Multi-Language Input for Localization

- ▶ The Advanced HMI supports multilingual inputs for:
 - Recipe Name (ENRCPG)
 - Recipe Group Name (ENRCPNO)
 - Recipe Content (Char)
 - User Name
- ▶ Supports 16 languages: English, Traditional Chinese, Simplified Chinese, French, German, Russian, Japanese, Korean, Spanish, Portuguese, Hindi, Turkish, Arabic, Persian, Italian and Polish

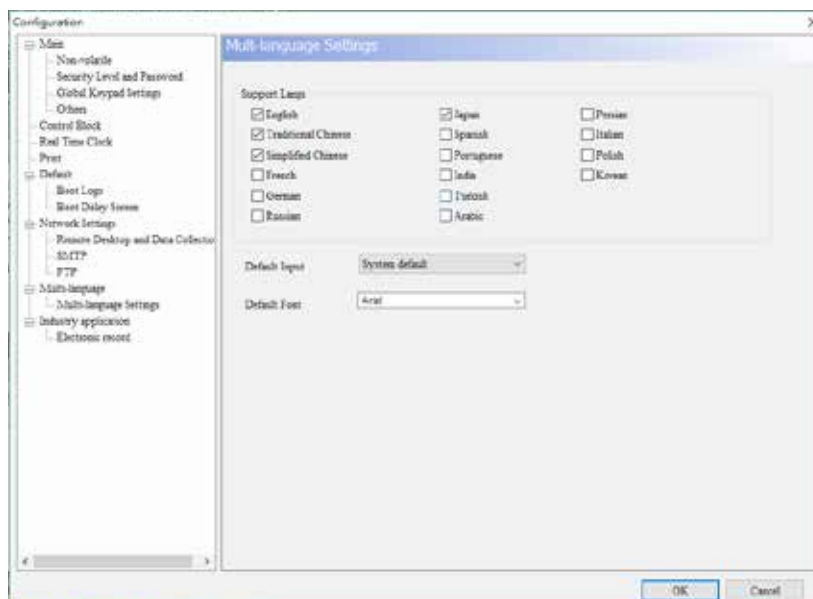

Standard HMI

The Standard HMI is equipped with 2 COM ports to meet most applications. It also offers Ethernet Types for fast and easy connection with other equipment.



Features



Embedded Linux System
Open system for flexible and stable program development



LUA Language
Simple and easy structural programming language to meet various demands



DOPSoft 4.0
New software DOPSoft 4.0 offers more complete functions and a better interface



Pressing times >10,000,000
Effective pressing times increased through strict endurance tests



Operating Temperature 0°C ~ 50°C
Compliant with industrial operation environments



IP65 Rating
The front case protects the HMI from snow, rain, and dust



CE / UL Certified
Compliant with CE and UL standards



Diagnostics Function
Collects and solves issues remotely



Ethernet Communication
Connects to master device or PLC with high-speed Ethernet communication



Power Isolation
Protects the HMI from accidental surge interference



Communication Isolation
COM and Ethernet ports with built-in isolation circuits enhance communication stability



VNC Remote Monitoring
Remote control with mobile devices



FTP/eMail Supported
Simple data transmission and real-time status report



Supports PDF and TXT Reader
PDF and TXT files supported



Supports GIF Graphic Elements
Easy setting to play vivid GIF elements



User-Friendly
Intuitive operation interfaces for users

Basic HMI

The Basic HMI features basic functions and easy installation for industrial applications. With an IP65 water-proof rating, it is suitable for harsh environments.



Features



Embedded Linux System
Open system for flexible and stable program development



LUA Language
Simple and easy structural programming language to meet various demands



DOPSoft 4.0
New software DOPSoft 4.0 offers more complete functions and a better interface



Pressing times >1,000,000
Effective pressing times increased through strict endurance tests



Operating Temperature 0°C ~ 50°C
Compliant with industrial operating environments



IP65 Rating
The front case protects the HMI from snow, rain, and dust



CE / UL Certified
Compliant with CE and UL standards



Diagnostics Function
Collects and solves issues remotely



Ethernet Communication
Connects to master device or PLC with high-speed Ethernet communication



FTP/eMail Supported
Simple data transmission and real-time status report



Communication Isolation
COM and Ethernet ports with built-in isolation circuits enhance communication stability



VNC Remote Monitoring
Remote control with mobile devices



Supports PDF and TXT Reader
PDF and TXT files supported



Diagnostics Function
Collects and solves issues remotely



User-Friendly
Intuitive operation interfaces for users

Robust Hardware

Power Isolation

- ▶ Complete series with built-in power isolation circuits provides the most complete protection against accidental external spikes

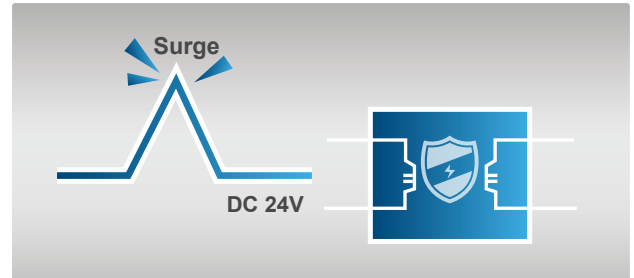

Fully Isolated Communication Interface

- ▶ Complete series has built-in COM and Ethernet isolation circuits to protect against noise that can occur from the grounding of various devices such as PLCs, servo drives, inverters and others



PCB Coating

- ▶ Complete series has PCB coating for enhanced durability and to protect against humidity and dust for applications in a range of environments

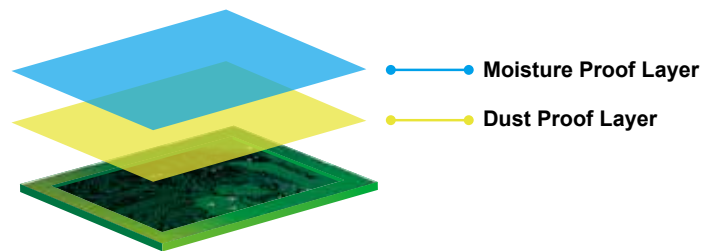

Model	Power Isolation	Communication Isolation
Advanced HMI (Multimedia Type)		
DOP-112/115 MX	Yes	Yes
Advanced HMI		
DOP-103WQ/107WV/110WS	Yes	Yes
DOP-112/115 WX	Yes	Yes
Standard HMI (Ethernet Type)		
DOP-107IV	Yes	Yes
DOP-108IG/110IG	Yes	Yes
DOP-110IS	Yes	Yes
DOP-107EV	Yes	Yes
DOP-107EG	Yes	Yes
Standard HMI		
DOP-105CQ	Yes	No
DOP-107CV	Yes	No
DOP-110CS	Yes	No
DOP-110CG	Yes	No
Standard HMI (General Type)		
DOP-107DV	No	No
Basic HMI		
DOP-103BQ	No	No
DOP-107BV	No	No

Programming Software – DOPSoft 4.0

Abundant Elements

- ▶ Abundant built-in element graphics for vivid interface display for a variety of industrial applications

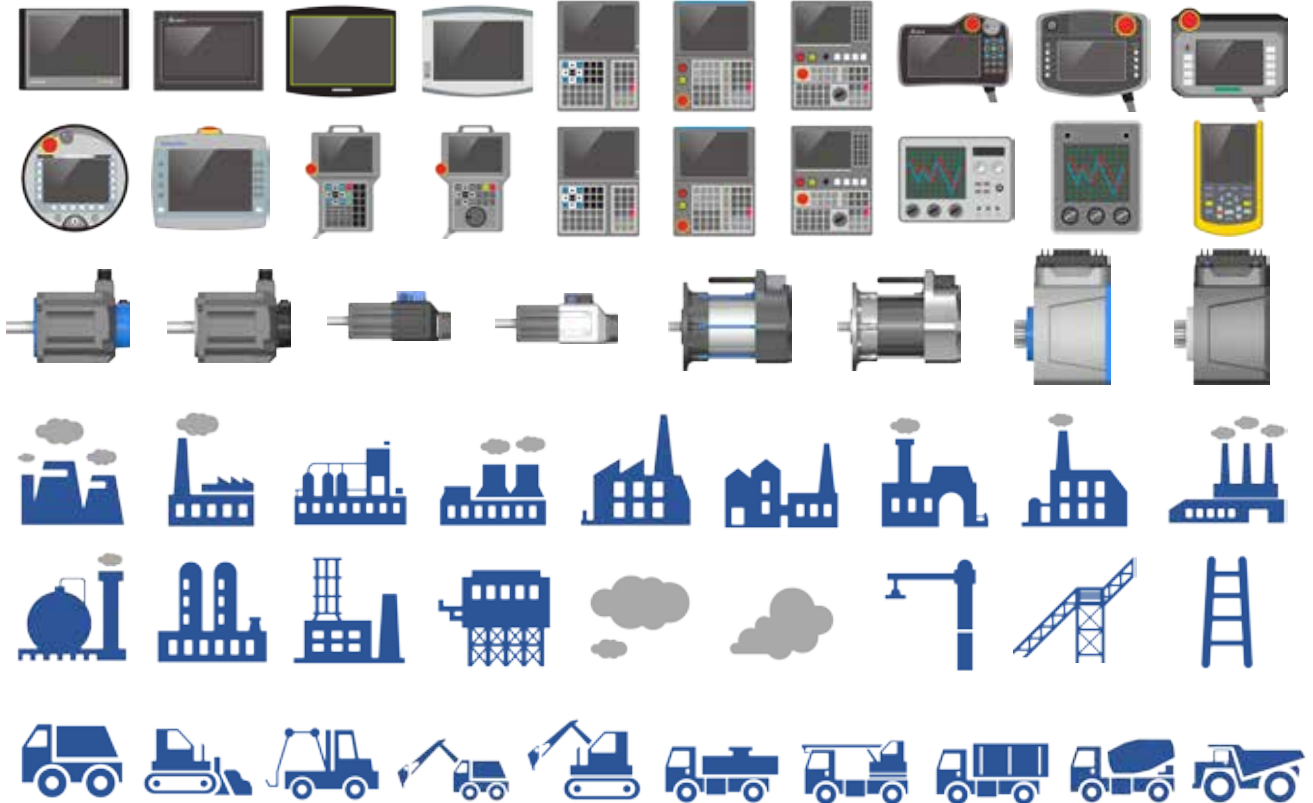

Smooth Animation

- ▶ New smooth animation technology for realistic dashboard display

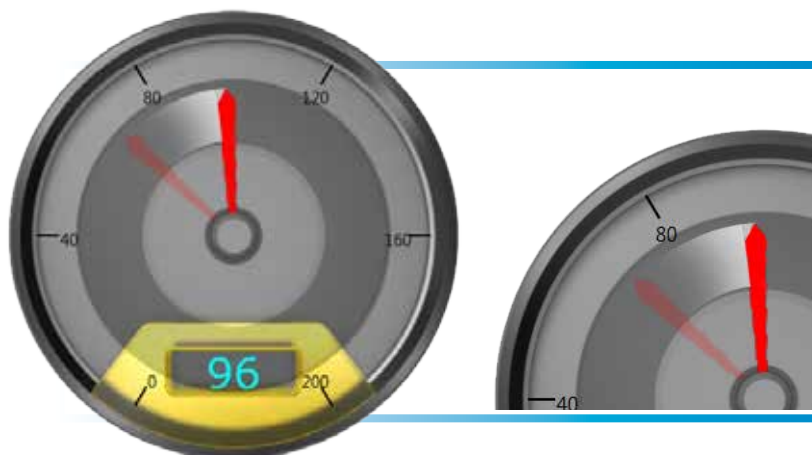

Programming Software - DOPSoft 4.0

User-friendly Programming Interface

The screenshot shows the DOPSoft 4.0 interface with several callout boxes pointing to specific features:

- Bookmark Management:** A green box pointing to the 'Screen_12' tab in the top right corner.
- Project Management Batch:** A green box pointing to the 'Project' tree view on the left side of the interface.
- Editing Area:** A green box pointing to the main workspace area where the HMI screen is being edited.
- Output List:** A green box pointing to the 'Output' window at the bottom left, which displays a list of messages and errors.
- Edit Preview:** A green box pointing to the 'Screen Management' window at the bottom right, which shows a preview of the overall project structure.

Additional interface elements visible include a menu bar (File, Edit, View, Element, Screen, Tools, Options, Window, Help), a toolbar with various icons, and a main workspace displaying a 3D industrial scene with tanks and pipes. The workspace also features a vertical menu on the left with options like 'Screen', 'Meter', 'Pie', 'Curve', 'Cag', and 'SysMenu'.

Customized keyboard



Abundant accessories

Process paradigms

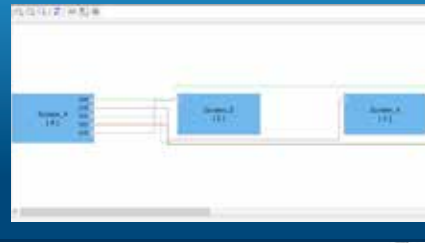

Field devices



Properties	
Screen Name	Screen_12
Screen Properties	Detail...
Background Color	<input type="checkbox"/> RGB(252, 252, 252)
Screen Lock Bit	None
Screen Macro	
Screen Open Macro	3
Screen Close Macro	0
Screen Cycle Macro	17
Width	1024
Height	768

Maintained	
Write Address:	\$5 0
Read Address:	None
Write Offset Address:	None
Read Offset Address:	None
Style:	Standard
Fireground Color:	
Blink:	No
Filed style:	Gradient

General Tool

Shortcut icons help enhance working efficiency

Property

Provides easier property setup via group lists

Property Quick Window

Standard accessory dialog box adopts built-in preview and quick-edit functions

Programming Software - DOPSoft 4.0

Editing Windows

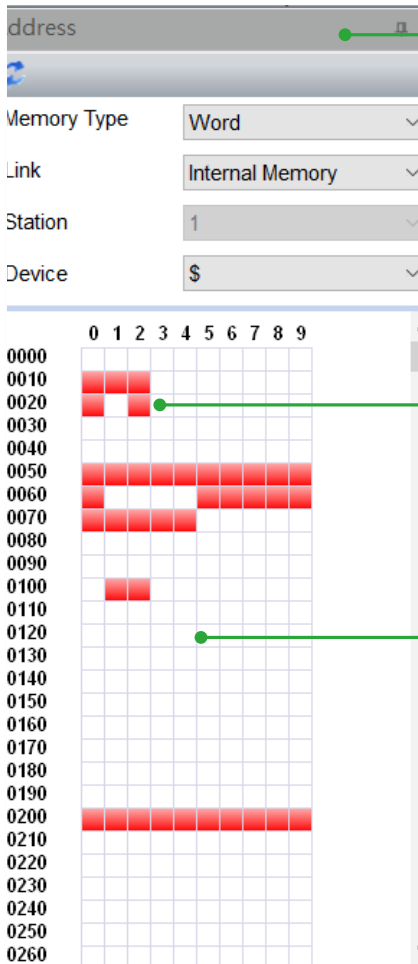

Register View Window

The color blocks of red and white allow users to view the memory register status



Red blocks indicate the used registers



White blocks indicate empty registers

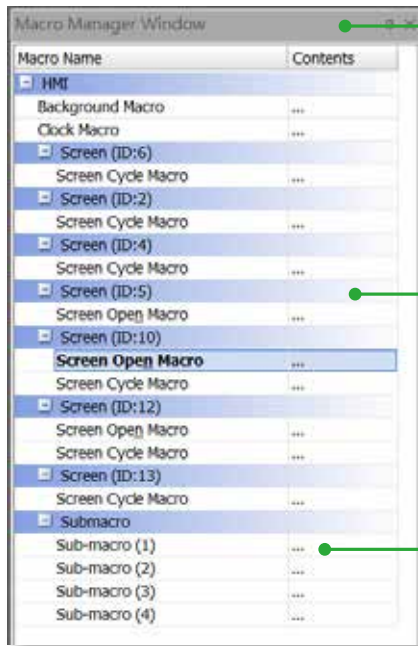

Macro Management Window

Users can view all types of macros in the project





Selected a macro via the list

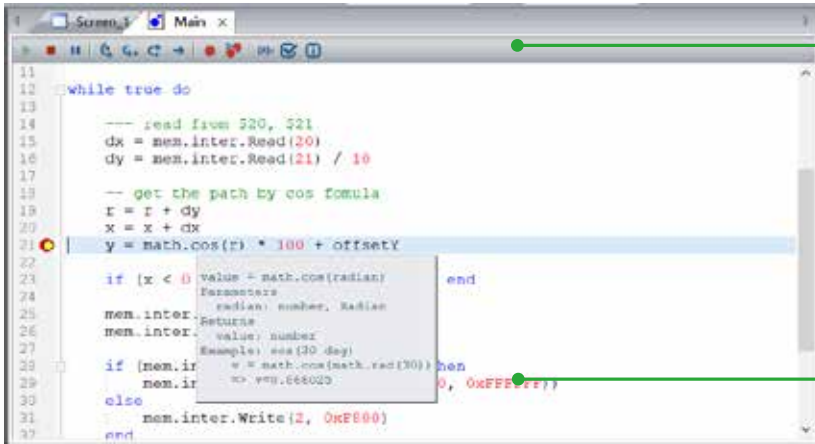

Directly edit the macro after clicking



Lua Tool Bar

-  Program Debugging
-  Stops program debug
-  Program break point

Online Coding Tips

Lua editor displays tip windows of the codes when users move the mouse to selected codes

Watch variable

Name	Value	Global / Local	Type	Format
dx	3	Global	Number	DEC
dy	0.1	Global	Number	DEC
r	0.1	Global	Number	DEC
x	3	Global	Number	DEC
y	0	Global	Number	DEC
name	nil	Local		DEC

Parameter Monitoring Window

Allows users to monitor parameter variation during program development

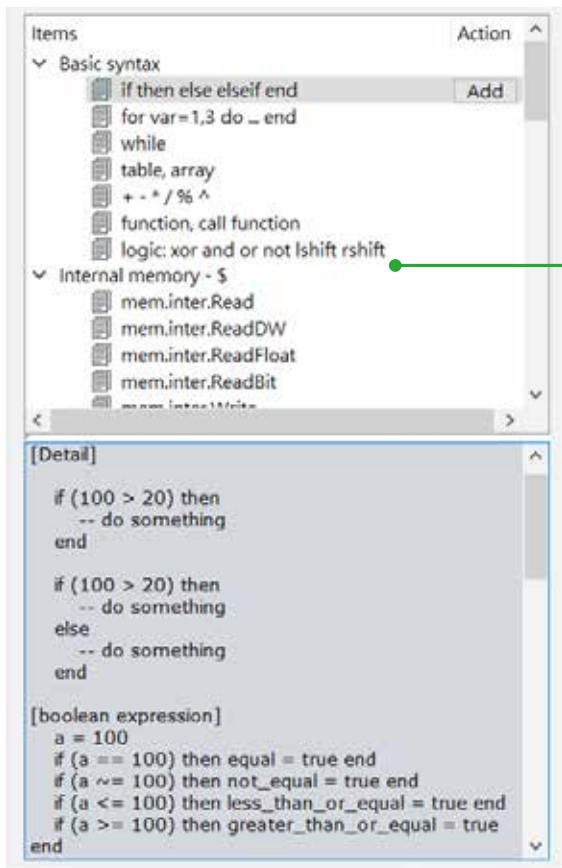

Programming Assistance Window

Provides online assistance as follows:

- Lua code templates
- Program usage and properties
- Program samples

Advanced Alarm

Strengthened alarm functions allow users to easily manage machine operations and quickly eliminate problems

- ▶ Alarm messages contain current register data for issue analysis

Detail			Properties
No.	Message Content	Category	
1*	Temp. too High , PV is %d1	1	
2*	Temp. too Low , PV is %d1	1	
3*	PV is %d1 , ALM Mail	2	
4		0	
5		0	

Message
Temp. too Low , PV is 12
Temp. too High , PV is 91
Temp. too Low , PV is 15
Temp. too Low , PV is 23

Alarm Sorting
 Alarm sorting via a "Sorting" function based on alarm attributes for quick information inquiries

Supports Compound Address Monitoring
 Able to monitor Word and Bit documents at the same time

Detail		Properties				
No.	Message Content	Category	Type	Address	Trigger Condition	Monitor Address
1*	Temp. too High , PV is %d1	1	Word	\$15	\$15 > 70	\$15
2*	Temp. too Low , PV is %d1	1	Word	\$15	\$15 < 30	\$15
3*	PV is %d1 , ALM Mail	2	Bit	\$198.4	On	\$15
4		0	Bit	None	On	None

Versatile Alarm Triggering Conditions
 Triggering conditions can be setup via a built-in function, no external editing programs required

Alarm Notification

Automatically sends out alarm notification emails to logged-in recipients when alarms occur and supports the Secure Sockets Layer (SSL) protocol to ensure safe data transmission



- Indicates the alarm trigger and recovery time, and provides alarm acknowledge time / date (Ack) to confirm and monitor troubleshooting progress

Message	Trigger	Ack	Recovery
Temp. too Low • PV is 12	15:07:12 02/03/2017		15:07:15 02/03/2017
Temp. too High • PV is 91	15:07:15 02/03/2017	15:07:56 02/03/2017	15:07:22 02/03/2017
Temp. too Low • PV is 15	15:07:22 02/03/2017		15:07:25 02/03/2017
Temp. too Low • PV is 23	15:07:28 02/03/2017	15:07:58 02/03/2017	15:07:34 02/03/2017

Alarm Filtering

Advanced address control filtering allows users to find specified alarm messages according to user needs

Action	
Address control filtering allows users to find specified alarms	
No.	Action
0	Preset state, shows all triggered alarms
1	Hide alarms with "Restore Time" and "Confirm Time"
2	Hide alarms with "Restore Time"
3	Hide alarms with "Restore Time" or "Confirm Time"
4	Hide alarms with "Confirm Time"

Alarm Ordering

Able to display alarms in the order of Trigger Time / Confirm Time / Restore Time

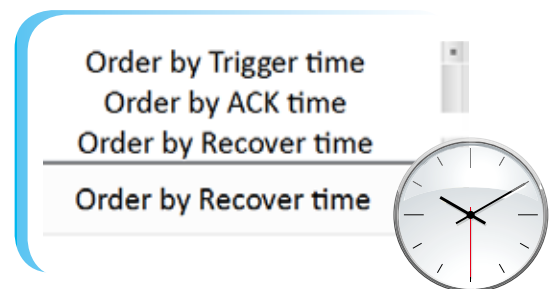

Data Management

Historical Data

- ▶ Able to generate historical reports with user-defined file names and timestamps through Bit Control

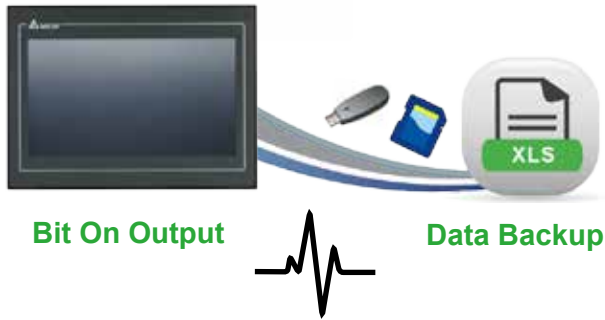

The "Save As Mul" dialog box contains the following settings:

- File Date:** None, %m, %d
- File Time:** %H, %M, None
- File Name:** DOP
- Saving trigger:** \$175.0

Historical Data Review

- ▶ Allows historical data review on backup in USB disk or SD cards



Zoom In / Out Display

- ▶ Zoom in / out function for convenient data viewing

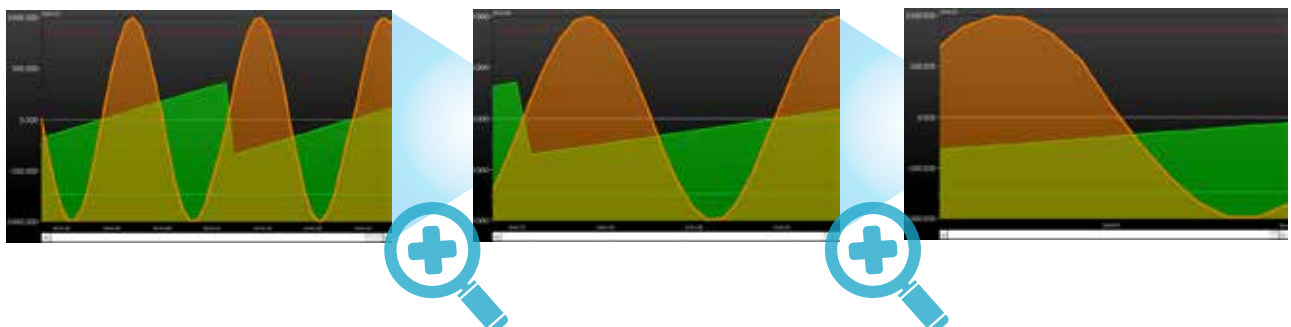

Recipes

- ▶ Supports 2D and 3D recipe grouping, more flexible in building recipe database
- ▶ Various recipe formats, including text format (Unicode) which can also be used as formula notes

	D100	D101	D102	D103	D104	D105	D106	
	D100	D101	D102	D103	D104	D105	D106	50.7
Cake Recipe 1	Strawberry	300	0	0	221.56	533.1	150.7	63.9
Cake Recipe 2	Chocolate	0	300	0	387.98	490.8	163.9	79.8
Cake Recipe 3	Vanilla	0	0	300	120.14	505.3	279.8	
	Strawberry	Chocolate	Vanilla		Sugar	Flour	Milk	
	Char	Unsigned DEC			Floating			

Recipe Group 2 (includes rows 1-4)

Recipe Group 1 (includes rows 5-6)

- ▶ Recipes can be saved in CSV files for convenient editing on PCs
- ▶ Allows recipe update or backup through USB disks, SD cards or FTP

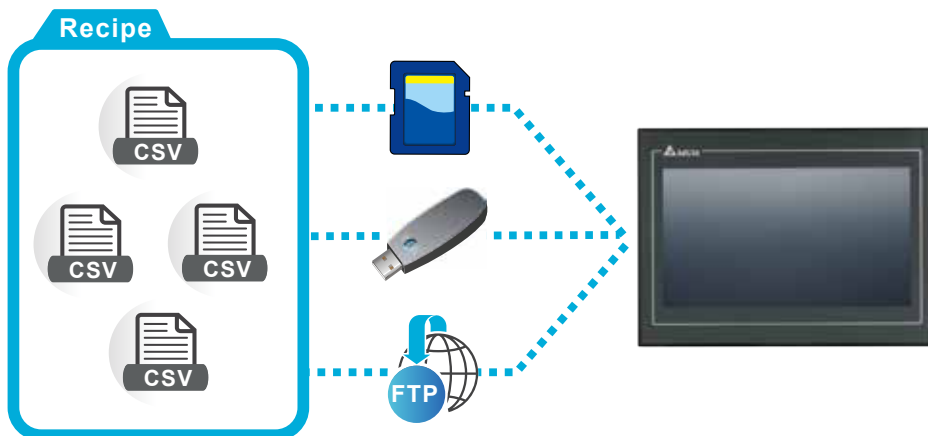

PDF for Data Review

- ▶ Saves manuals or instruction PDF files in USB disks or SD cards for reference anytime



User Authority Management

Account and Authorization Management

- ▶ Supports 8 levels of authority and allows 8 accounts (account name/password) for each level
- ▶ Different function and operation access for each authority level to enhance operation safety



Operation Log

- ▶ Operation log for different user accounts to trace/analyze possible causes of malfunctions
- ▶ Provides comprehensive information for managers to analyze the operating habits of different users and improve efficiency

Time	Date	User	Level	Screen	Action	Address	Pre Value	Change Value	Descriptor
19:22:18	2016.12.02	MANAGER	7	Screen_6	Goto Scrn		6	1	換畫面_006
19:22:20	2016.12.02	MANAGER	7	Screen_1	Goto Scrn		1	10	換畫面_001
19:22:24	2016.12.02	MANAGER	7	Screen_10	Set Val	\$51.1	1	0	交替型_003
19:22:27	2016.12.02	MANAGER	7	Screen_10	Goto Scrn		10	1	換畫面_006
19:22:30	2016.12.02	MANAGER	7	Screen_1	Goto Scrn		1	7	換畫面_001
19:22:57	2016.12.02	MANAGER	7	Screen_7	Set Val	\$20	-730	-698	數值輸入_0
19:23:02	2016.12.02	MANAGER	7	Screen_7	Goto Scrn		7	1	換畫面_006
19:23:05	2016.12.02	MANAGER	7	Screen_1	Goto Scrn		1	6	換畫面_001
19:23:47	2016.12.02	MANAGER	7	Screen_6	Level Switch		7	4	密碼輸入_0
19:23:52	2016.12.02	OPERATOR	4	Screen_6	Goto Scrn		6	1	換畫面_006
19:23:55	2016.12.02	OPERATOR	4	Screen_1	Goto Scrn		1	3	換畫面_001
19:24:03	2016.12.02	OPERATOR	4	Screen_3	Set Val	ENRCP10	12ED	65AE	數值輸入_0
19:24:09	2016.12.02	OPERATOR	4	Screen_3	Set Val	ENRCP11	456.32	125.93	數值輸入_0
19:24:14	2016.12.02	OPERATOR	4	Screen_3	Set Val	ENRCP17	400	452	數值輸入_0
19:24:15	2016.12.02	OPERATOR	4	Screen_3	Goto Scrn		3	1	換畫面_006
19:24:17	2016.12.02	OPERATOR	4	Screen_1	Goto Scrn		1	6	換畫面_001

Cloud Integration



Only With Ethernet

FTP Server

- ▶ Built-in FTP server to update recipes or PDF files, and backup historical data, operation log and alarms

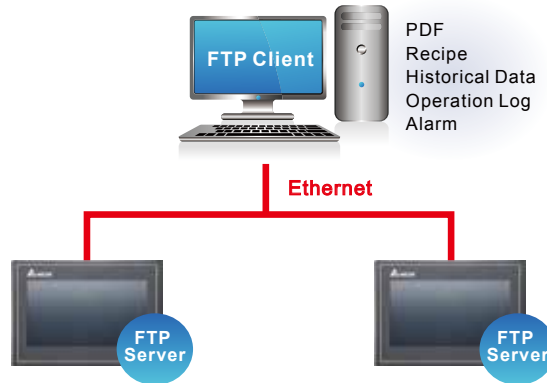

VNC Server

- ▶ Built-in VNC server allows remote monitoring and operating of the DOP-100 Series via VNC Client APP (Windows, iOS, Android)
- ▶ Lock function: block remote operation during on-site operation to avoid unsynchronized commands. VNC server allows remote monitoring but not remote operation when the lock function is on

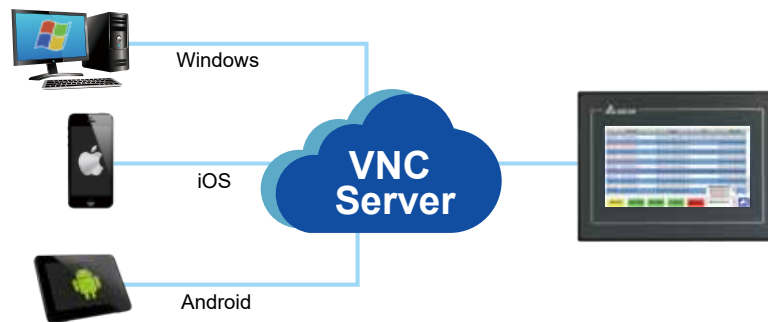

Web Monitoring

- ▶ Allows direct monitoring of register data via web page, and requires no additional software installation

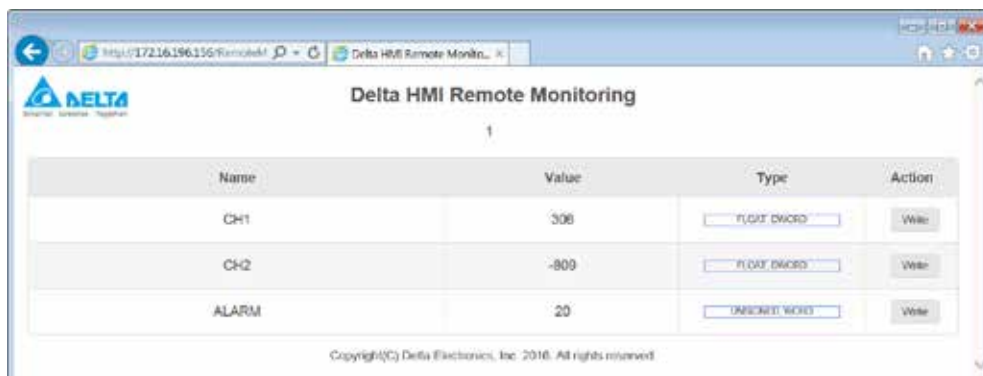

Hardware Specifications

Advanced HMI

Model		Advanced Narrow Frame Type		
		DOP-103WQ	DOP-107WV	DOP-110WS
LCD Module	Display	4.3" TFT LCD	7" TFT LCD	10.1" TFT LCD
	Color	65,536		
	Resolution (Pixels)	480 x 272	800 x 480	1024 x 600
	Back Light	LED Back Light		
	Back Light Brightness (cd/m ²)	400	450	450
	Back Light Life (Hour) ¹	10,000	20,000	30,000
	Display Area	95.04 x 53.856 mm	154.08 x 85.92 mm	225.52 x 128.10 mm
MCU	ARM Cortex-A8 (800MHz)			
Flash ROM (Bytes)	256 MB			
RAM (Bytes)	512 MB			
Touch Panel	Four-wire resistor, over 10,000,000 pressing times			
Buzzer	Multi-Tone Frequency (2K ~ 4K Hz) / 80dB			
Ethernet Interface	1 Port ² , 10/100 Mbps auto-sensing			
USB	1 USB Slave Ver 2.0 / 1 USB Host Ver 2.0			
SD	N/A			
Serial COM Port	COM1	RS-232 (supports hardware flow control) / RS-485 ²	RS-232 (supports hardware flow control)	
	COM2	RS-422 / RS-485 ²	RS-232 (supports hardware flow control) / RS-485 ²	
	COM3	N/A	RS-422 / RS-485 ²	
RTC	Built-in			
Cooling	Natural air circulation			
Certification	CE / UL			
Waterproof	IP65 / NEMA4 / UL Type 4X (indoor use only)			
Operation Voltage ³	DC +24V (-15% ~ 15%) ²			
Voltage Endurance	A599V for 1 minute (between charging DC24 terminal and FG terminals)			
Power Consumption ⁵	Max. 5.8W ³	Max. 8.4W ³	Max. 11W ³	
Backup Battery	3V lithium battery CR2032 × 1			
Backup Battery Life	Depends on the temperature used and the conditions of usage, usually about 3 years or more at 25° C			
Operating Temperature	0°C ~ 50°C			
Storage Temperature	-20°C ~ 60°C			
Ambient Humidity	10% ~ 90% RH (0 ~ 40° C), 10% ~ 55% RH (41 ~ 50° C), Pollution Degree 2			
Vibration	IEC 61131-2 compliant 5Hz ~ 8.3Hz = Continuous: 3.5mm, 8.3Hz ~ 150Hz = Continuous: 1.0g			
Shock	IEC 60068-2-27 compliant 15g peak for 11ms duration, X, Y, Z, directions for 6 times			
Dimensions (W) x (H) x (D) mm	137 x 103 x 37.1	196 x 136 x 39	270 x 180.9 x 47.75	
Mounting dimension (W) x (H) mm	118.8 x 92.8	186.8 x 126.8	255 x 170.5	
Weight	280g	560g	1,100g	

1) The half-life of a backlight is defined as the original luminance being reduced by 50% when the maximum driving current is supplied to an HMI.

2) Built-in power isolation

3) An isolated power supply is recommended.

4) Some models are in the process of application for UL and KCC certification. For more information, please consult our distributors.

5) The value of the power consumption indicates the electrical power consumed by the HMI with no peripheral devices connected.

6) The content of this catalogue may be revised without prior notice. Please consult our distributors or download the most updated version at <http://www.deltaww.com>

Advanced HMI

Model		Advanced Narrow Frame Type		Advanced Multimedia Type	
		DOP-112WX	DOP-115WX	DOP-112MX	DOP-115MX
LCD Module	Display	12" TFT LCD	15" TFT LCD	12" TFT LCD	15" TFT LCD
	Color	24bit			
	Resolution (Pixels)	1024 x 768			
	Back Light	LED Back Light			
	Back Light Brightness (cd/m ²)	500	450	500	450
	Back Light Life (Hour) ¹	50,000			
	Display Area	245.76 x 184.32 mm	304.1 x 228.1 mm	245.76 x 184.32 mm	304.1 x 228.1 mm
MCU		Dual Core 1GHz			
Flash ROM (Bytes)		8GB			
RAM (Bytes)		DDR3 1000MHz 1GB			
Touch Panel		Four-wire resistor, over 10,000,000 pressing times			
Buzzer		Multi-Tone Frequency (2K ~ 4K Hz) / 85dB			
Ethernet Interface		2 Port, 100M bps x 2			
USB		1 Mini USB Slave Ver 2.0 / 1 USB Host Ver 2.0			
SD		SD x 1			
Serial COM Port	COM1	RS-232 (supporting flow control) / RS485 ²			
	COM2	RS-422 / RS485 ²			
	COM3	RS-232 (supporting flow control) / RS-485 ²			
	COM4	RS-422 / RS485			
RTC		Built-in			
Cooling		Natural air circulation			
Certification		CE / UL			
Waterproof		IP65 / NEMA4 / UL Type 4X (indoor use only)			
Operation Voltage ³		DC +24V (-15% ~ 15%) ²			
Voltage Endurance		A599V for 1 minute (between charging DC24 terminal and FG terminals)			
Power Consumption ⁵		Max. 16.08W	Max. 21.12W	Max. 16.08W	Max. 21.12W
Backup Battery		3V lithium battery CR2032 x 1			
Backup Battery Life		Depends on the temperature used and the conditions of usage, usually about 3 years or more at 25° C			
Operation Temperature		0°C ~ 50°C			
Storage Temperature		-20°C ~ 60°C			
Ambient Humidity		10% ~ 90% RH (0 ~ 40° C), 10% ~ 55% RH (41 ~ 50° C), Pollution Degree 2			
Vibration		IEC 61131-2 compliant 5Hz ~ 8.3Hz = Continuous: 3.5mm, 8.3Hz ~ 150Hz = Continuous: 1.0g			
Shock		IEC 60068-2-27 compliant 15g peak for 11ms duration, X, Y, Z, directions for 6 times			
Dimensions (W) x (H) x (D) mm		317.4 x 246.4 x 52.7	387.7 x 295.7 x 63.5	317.4 x 246.4 x 52.7	387.7 x 295.7 x 63.5
Mounting dimension (W) x (H) mm		302.7 x 228.7	372.4 x 283.7	302.7 x 228.7	372.4 x 283.7
Weight		2110g	3200g	2110g	3200g

1) The half-life of a backlight is defined as the original luminance being reduced by 50% when the maximum driving current is supplied to an HMI.

4) Built-in power isolation

5) An isolated power supply is recommended.

4) Some models are in the process of application for UL and KCC certification. For more information, please consult our distributors.

7) The value of the power consumption indicates the electrical power consumed by the HMI with no peripheral devices connected.

8) The content of this catalogue may be revised without prior notice. Please consult our distributors or download the most updated version at <http://www.deltaww.com>

Hardware Specifications

Standard HMI

Model		Standard General Type			
		DOP-105CQ	DOP-107CV	DOP-110CS	DOP-110CG
LCD Module	Display	5.6" TFT LCD	7" TFT LCD	10" TFT LCD	10.4" TFT LCD
	Color	65,536			
	Resolution (Pixels)	320 x 234	800 x 480	1024 x 600	800 x 600
	Back Light	LED Back Light			
	Back Light Brightness (cd/m ²)	200	400	300	300
	Back Light Life (Hour) ¹	20000			
	Display Area	113.28 x 84.70 mm	154.08 X 85.92 mm	226 X 128.7 mm	211.2 x 158.4 mm
MCU	ARM Cortex-A8 (800MHz)				
Flash ROM (Bytes)	256 Mbytes				
RAM (Bytes)	256 Mbytes				
Touch Panel	Four-wire resistor, over > 10,000,000 pressing times			Four-wire resistor, over > 1,000,000 pressing times	
Audio Output	Buzzer	Multi-Tone Frequency (2K ~ 4K Hz) / 80dB			
	AUX	N/A			
USB	1 USB Slave Ver 2.0 / 1 USB Host Ver 2.0				
SD	N/A				
Serial COM Port	COM1	RS-232 (supports hardware flow control) ²			
	COM2	RS-232 (supports hardware flow control) / RS-485 ²			
	COM3	RS-422 / RS-485 ²			
RTC	Built-in				
Cooling	Nature air circulation				
Certification	CE / UL (please equip shielding cables and linefilters with capacity of 300ohm/100MHz)				
Waterproof	IP65 / NEMA4 / UL Type 4X (indoor use only)				
Operation Voltage ³	DC +24V (-15% ~ +15%)(please equip isolated-type power supplies) Supplied by Class 2 or SELV circuit (isolated from MAINS by double insulation)				
Voltage Endurance	A500V for 1 minute (between charging DC24 terminal and FG terminals)				
Power Consumption ⁵	Max. 6.86 W ³	Max. 8.5 W ³	Max. 10.4 W ³	Max. 8W ³	
Backup Battery	3V lithium battery CR2032 × 1				
Backup Battery Life	Depends on the temperature used and the conditions of usage, usually about 3 years or more at 25° C				
Operation Temperature	0°C ~ 50°C				
Storage Temperature	-20°C ~ 60°C				
Ambient Humidity	10% ~ 90% RH (0 ~ 40° C), 10% ~ 55% RH (41 ~ 50° C), Pollution Degree 2				
Vibration	IEC 61131-2 compliant 5Hz ~ 8.3Hz = Continuous: 3.5mm, 8.3Hz ~ 150Hz = Continuous: 1.0g				
Shock	IEC 60068-2-27 compliant 15g peak for 11ms duration, X, Y, Z, directions for 6 times				
Dimensions (W) x (H) x (D) mm	184 x 144 x 50	215 x 161 x 61.2	272 x 200 x 61	229 x 224 x 46.8	
Mounting dimension (W) x (H) mm	172.4 x 132.4	196.9 x 142.9	261.3 x 189.3	285.2 x 210.2	
Weight	670 g	970 g	1330g	1735 g	

1) The half-life of a backlight is defined as the original luminance being reduced by 50% when the maximum driving current is supplied to an HMI.6

2) Built-in power isolation

3) An isolated power supply is recommended.

4) Some models are in the process of application for UL and KCC certification. For more information, please consult our distributors.

5) The value of the power consumption indicates the electrical power consumed by the HMI with no peripheral devices connected.

6) The content of this catalogue may be revised without prior notice. Please consult our distributors or download the most updated version at <http://www.deltaww.com>

Standard HMI

Model		Standard Ethernet Type (2 COM)	
		DOP-107EG	DOP-107EV
LCD Module	Display	7" TFT LCD	7" TFT LCD
	Color	65,536	
	Resolution (Pixels)	800 x 600	800 x 480
	Back Light	LED Back Light	
	Back Light Brightness (cd/m ²)	450	400
	Back Light Life (Hour) ¹	20000	20000
	Display Area	141 X 105.75 mm	154.08 X 85.92 mm
MCU		ARM Cortex-A8 (800MHz)	
Flash ROM (Bytes)		256 Mbytes	
RAM (Bytes)		256 Mbytes	
Touch Panel		Four-wire resistor, over > 10,000,000 pressing times	
Audio Output	Buzzer	Multi-Tone Frequency (2K ~ 4K Hz) / 80dB	
	AUX	Stereo output	N/A
Ethernet Interface		1 Port ² , 10/100 Mbps auto-sensing	
USB		1 USB Slave Ver 2.0; 1 USB Host Ver 2.0	
SD		SDx 1	N/A
Serial COM Port	COM1	RS-232 (supports hardware flow control) ²	
	COM2	RS-232 (supports hardware flow control) / RS-485 ²	
	COM3	RS-422 / RS-485 ²	
RTC		Built-in	
Cooling		Natural air circulation	
Certification		CE / UL (please equip Shielding cables and linefilters with capacity of 300ohm/100MHz)	
Waterproof		IP65 / NEMA4 / UL Type 4X (indoor use only)	
Operation Voltage ³		DC +24V (-15% ~ +15%)(please equip isolated-type power supplies) Supplied by Class 2 or SELV circuit (isolated from MAINS by double insulation)	
Voltage Endurance		A500V for 1 minute (between charging DC24 terminal and FG terminals)	
Power Consumption ⁵		Max. 8.4 W ³	Max. 8.76 W ³
Backup Battery		3V lithium battery CR2032 × 1	
Backup Battery Life		Depends on the temperature used and the conditions of usage, usually about 3 years or more at 25° C	
Operating Temperature		0°C ~ 50°C	
Storage Temperature		-20 °C ~ 60 °C	
Ambient Humidity		10% ~ 90% RH (0 ~ 40° C), 10% ~ 55% RH (41 ~ 50° C), Pollution Degree 2	
Vibration		IEC 61131-2 compliant 5Hz ~ 8.3Hz = Continuous: 3.5mm, 8.3Hz ~ 150Hz = Continuous: 1.0g	
Shock		IEC 60068-2-27 compliant 15g peak for 11ms duration, X, Y, Z, directions for 6 times	
Dimensions (W) x (H) x (D) mm		184 x 144 x 51.5	215 x 161 x 61.2
Mounting dimension (W) x (H) mm		172.4 x 132.4	196.9 x 142.9
Weight		800g	970g

1) The half-life of a backlight is defined as the original luminance being reduced by 50% when the maximum driving current is supplied to an HMI.

2) Built-in power isolation

3) An isolated power supply is recommended.

4) Some models are in the process of application for UL and KCC certification. For more information, please consult our distributors.

5) The value of the power consumption indicates the electrical power consumed by the HMI with no peripheral devices connected.

6) The content of this catalogue may be revised without prior notice. Please consult our distributors or download the most updated version at <http://www.deltaww.com>

Hardware Specifications

Standard HMI

Model		Standard Ethernet Type (3 COM)			
		DOP-107IV	DOP-108IG	DOP-110IS	DOP-110IS
LCD Module	Display	7" TFT LCD	8" TFT LCD	10.1" TFT LCD	10.4" TFT LCD
	Color	65,536			
	Resolution (Pixels)	800 x 480	800 x 600	1024 x 600	800 x 600
	Back Light	LED Back Light			
	Back Light Brightness (cd/m ²)	400	250	300	300
	Back Light Life (Hour) ¹	20000			
	Display Area	152.4 x 91.44 mm	162 x 121.5 mm	226 x 128.7 mm	211.2 x 158.4 mm
MCU		ARM Cortex-A8 (800MHz)			
Flash ROM (Bytes)		256 Mbytes			
RAM (Bytes)		256 Mbytes			
Touch Panel		Four-wire resistor, over > 10,000,000 pressing times			
Audio Output	Buzzer	Multi-Tone Frequency (2K ~ 4K Hz) / 80dB			
	AUX	N/A	Stereo output		
Ethernet Interface		1 Port ² , 10/100 Mbps auto-sensing			
USB		1 USB Slave Ver 2.0 / 1 USB Host Ver 2.0			
SD		SD x 1			
Serial COM Port	COM1	RS-232 (supports hardware flow control) ²			
	COM2	RS-232 (supports hardware flow control) / RS-485 ²			
	COM3	RS-232 (supports hardware flow control) / RS-422 / RS-485 ²			
RTC		Built-in			
Cooling		Nature air circulation			
Certification		CE / UL (please equip shielding cables and linefilters with capacity of 300ohm/100MHz)			
Waterproof		IP65 / NEMA4 / UL Type 4X (indoor use only)			
Operation Voltage ³		DC +24V (-15% ~ +15%)(please equip isolated-type power supplies) Supplied by Class 2 or SELV circuit (isolated from MAINS by double insulation)			
Voltage Endurance		A500V for 1 minute (between charging DC24 terminal and FG terminals)			
Power Consumption ⁵		Max. 12W ³	Max. 9.88W ³	Max. 9.6W ³	Max. 9.6W ³
Backup Battery		3V lithium battery CR2032 × 1			
Backup Battery Life		Depends on the temperature used and the conditions of usage, usually about 3 years or more at 25° C			
Operation Temperature		0° C ~ 50° C			
Storage Temperature		-20° C ~ 60° C			
Ambient Humidity		10% ~ 90% RH (0 ~ 40° C), 10% ~ 55% RH (41 ~ 50° C), Pollution Degree 2			
Vibration		IEC 61131-2 compliant 5Hz ~ 8.3Hz = Continuous: 3.5mm, 8.3Hz ~ 150Hz = Continuous: 1.0g			
Shock		IEC 60068-2-27 compliant 15g peak for 11ms duration, X, Y, Z, directions for 6 times			
Dimensions (W) x (H) x (D) mm		215 x 161 x 61.2	227.1 x 174.1 x 61	272.6 x 200.6 x 54	299 x 224 x 46.8
Mounting dimension (W) x (H) mm		196.9 x 142.9	219.4 x 166.5	261.3 x 189.3	285.2 x 210.2
Weight		970 g	1226 g	1130 g	1600 g

1) The half-life of a backlight is defined as the original luminance being reduced by 50% when the maximum driving current is supplied to an HMI.6

2) Built-in power isolation

3) An isolated power supply is recommended.

4) Some models are in the process of application for UL and KCC certification. For more information, please consult our distributors.

5) The value of the power consumption indicates the electrical power consumed by the HMI with no peripheral devices connected.

6) The content of this catalogue may be revised without prior notice. Please consult our distributors or download the most updated version at <http://www.deltaww.com>

Basic HMI

Model		Basic Type		Basic Ethernet Type
		DOP-103BQ	DOP-107BV	DOP-107DV
LCD Module	Display	4.3" TFT LCD	7" TFT LCD	7" TFT LCD
	Color	65,536		
	Resolution (Pixels)	480 x 272	800 x 480	800 x 400
	Back Light	LED Back Light		
	Back Light Brightness (cd/m ²)	400		
	Back Light Life (Hour) ¹	20000		
	Display Area	95.04 x 53.856 mm	154.08 x 85.92 mm	154.08 x 85.92 mm
MCU		ARM Cortex-A8 (800MHz)		
Flash ROM (Bytes)		256 Mbytes		
RAM (Bytes)		256 Mbytes		
Touch Panel		Four-wire resistor, over > 10,000,000 pressing times		
Audio Output	Buzzer	Multi-Tone Frequency (2K ~ 4K Hz) / 80dB		
	AUX	N/A		
Ethernet Interface		N/A	N/A	1 Port, 10/100 Mbps auto-sensing ²
USB		1 USB Slave Ver 2.0 / 1 USB Host Ver 2.0		
SD		N/A		
Serial COM Port	COM1	RS-232/RS-485 (supports hardware flow control) ²		
	COM2	RS-422 / RS-485 ²		
	COM3	N/A		
RTC		Built-in		
Cooling		Nature air circulation		
Certification		CE / UL (please equip shielding cables and linefilters with capacity of 300ohm/100MHz)		
Waterproof		IP65 / NEMA4 / UL Type 4X (indoor use only)		
Operation Voltage ³		DC +24V (-15% ~ +15%)(please equip isolated-type power supplies) Supplied by Class 2 or SELV circuit (isolated from MAINS by double insulation)		
Voltage Endurance		A500V for 1 minute (between charging DC24 terminal and FG terminals)		
Power Consumption ⁵		Max. 5.67W ³	Max. 8.6 W ³	Max. 8.8W ³
Backup Battery		3V lithium battery CR2032 × 1		
Backup Battery Life		Depends on the temperature used and the conditions of usage, usually about 3 years or more at 25° C		
Operation Temperature		0°C ~ 50°C		
Storage Temperature		-20°C ~ 60°C		
Ambient Humidity		10% ~ 90% RH (0 ~ 40° C), 10% ~ 55% RH (41 ~ 50° C), Pollution Degree 2		
Vibration		IEC 61131-2 compliant 5Hz ~ 8.3Hz = Continuous: 3.5mm, 8.3Hz ~ 150Hz = Continuous: 1.0g		
Shock		IEC 60068-2-27 compliant 15g peak for 11ms duration, X, Y, Z, directions for 6 times		
Dimensions (W) x (H) x (D) mm		137 x 103 x 37.1	215 x 161 x 35.5	215 x 161 x 35.5
Mounting dimension (W) x (H) mm		118.8 x 92.8	196 x 142.9	196 x 142.9
Weight		280g	700g	700g

1) The half-life of a backlight is defined as the original luminance being reduced by 50% when the maximum driving current is supplied to an HMI.6

2) Built-in power isolation

3) An isolated power supply is recommended.

4) Some models are in the process of application for UL and KCC certification. For more information, please consult our distributors.

5) The value of the power consumption indicates the electrical power consumed by the HMI with no peripheral devices connected.

6) The content of this catalogue may be revised without prior notice. Please consult our distributors or download the most updated version at <http://www.deltaww.com>

Model Description

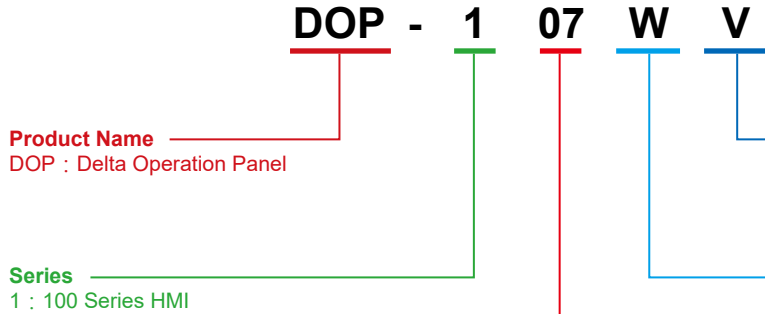

Display Size				
00 : Zero	03 : 4.3"	05 : 5.6"	7 : 7"	8 : 8"
10 : 10.1" / 10.4"	12 : 12"	15 : 15"		

Resolution	
G : SVGA TFT (800x)	Q : WQVGA TFT (480x)
S : WSVGA TFT (1024x)	V : WVGA TFT (800x)
X : XGA TFT (1024x)	Z : No Display (Zero)

Type
B : Basic Type
D : Basic Ethernet Type
C : Standard General Type
E : Standard Ethernet Type (2 COM)
I : Standard Ethernet Type (3 COM)
W : Advanced Narrow Frame Type
M : Advanced Multimedia Type

Dimensions Unit: mm (inches)

• DOP-103WQ

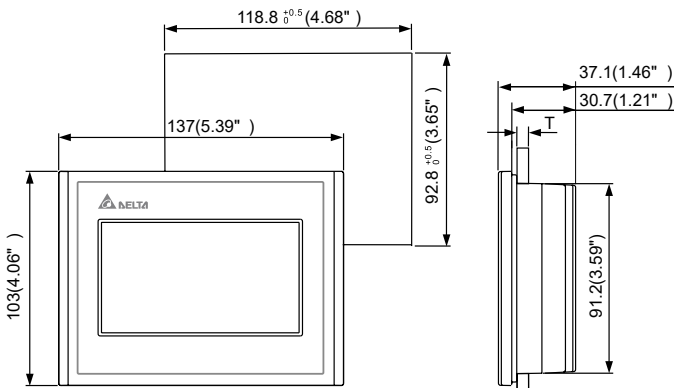

Note :
T=1.6mm~3mm(0.063"~0.12")

• DOP-107WV

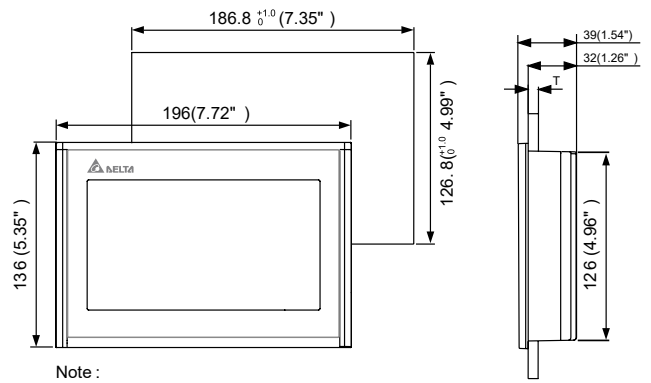

Note :
T=1.6mm~6mm(0.063"~0.24")

• DOP-110WS

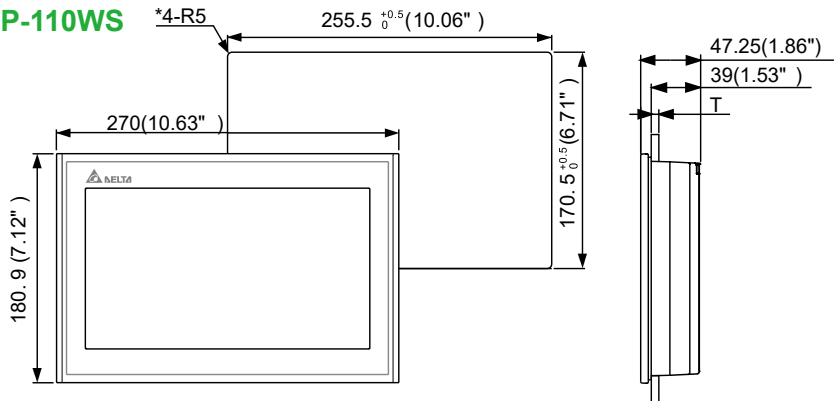

Note :
T=1.6mm~6mm(0.063"~0.24")

Dimensions Unit: mm (inches)

• DOP-112MX / DOP-112WX

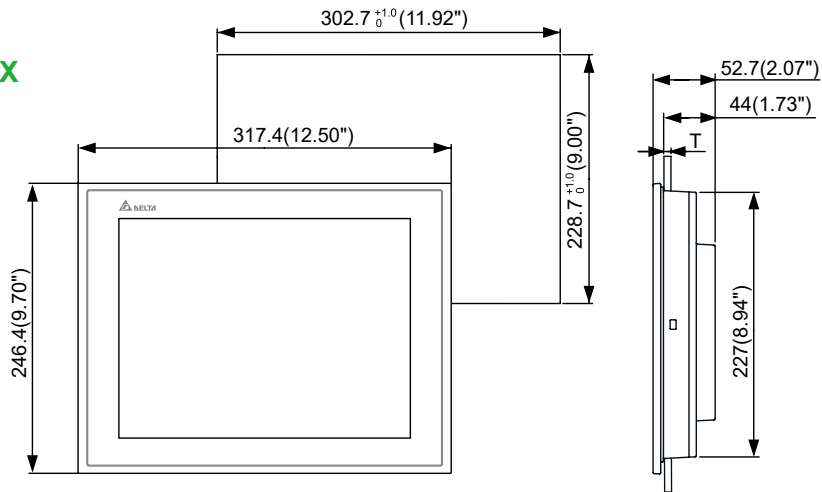

Note:
T=1.6 mm ~ 6 mm(0.063" ~ 0.24")

• DOP-115MX / DOP-115WX

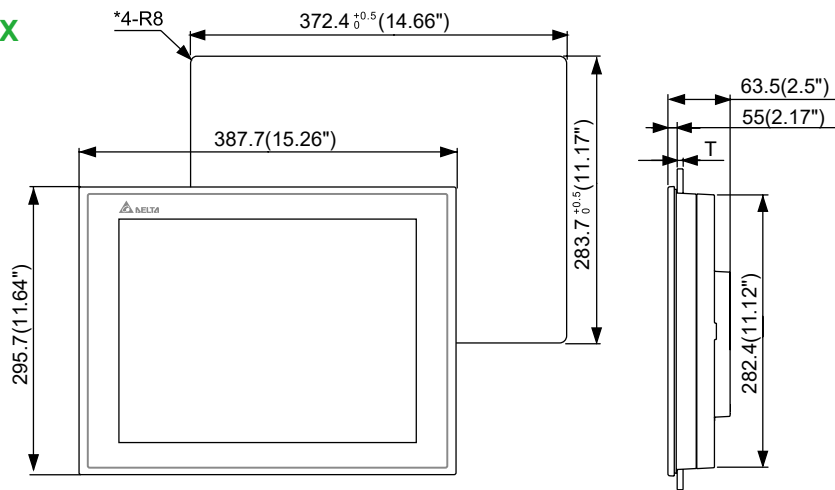

Note:
T=1.6 mm ~ 6 mm(0.063" ~ 0.24")

• DOP-107IV

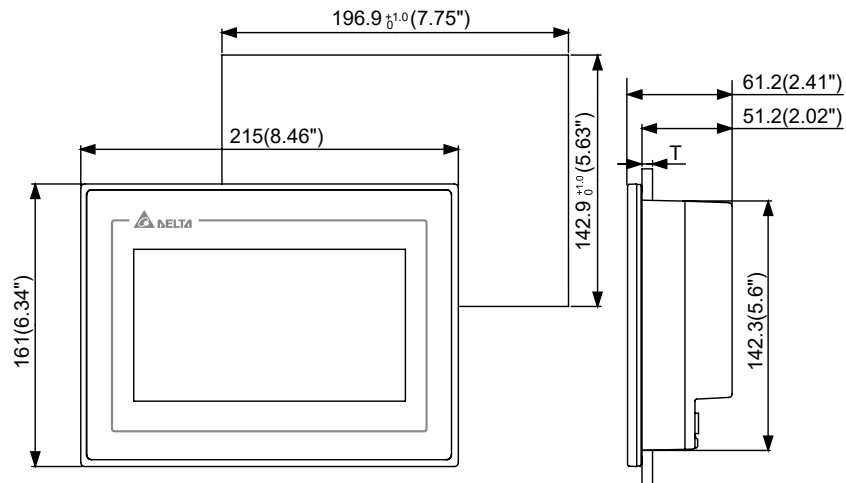

Note:
T=1.6 mm ~ 6 mm(0.063" ~ 0.24")

Dimensions Unit: mm (inches)

• DOP-108IG

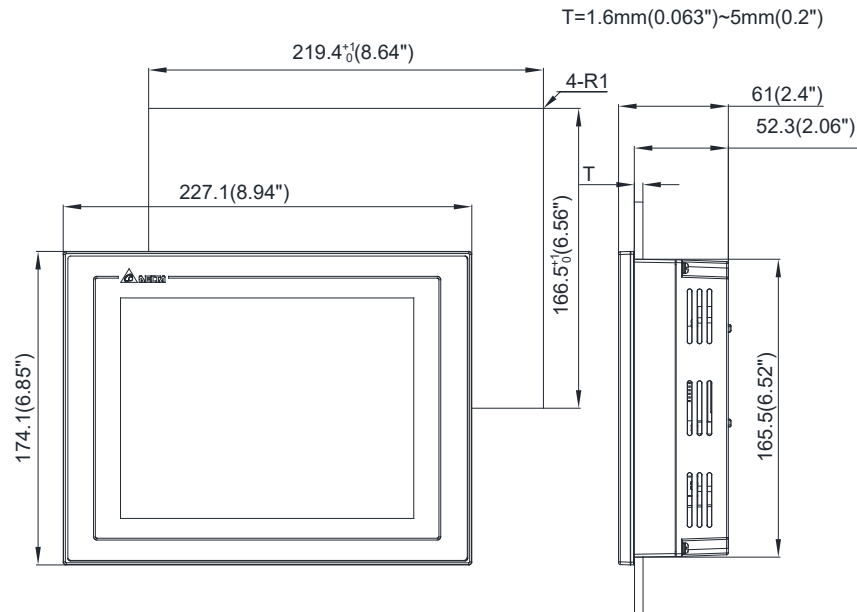

• DOP-110IS

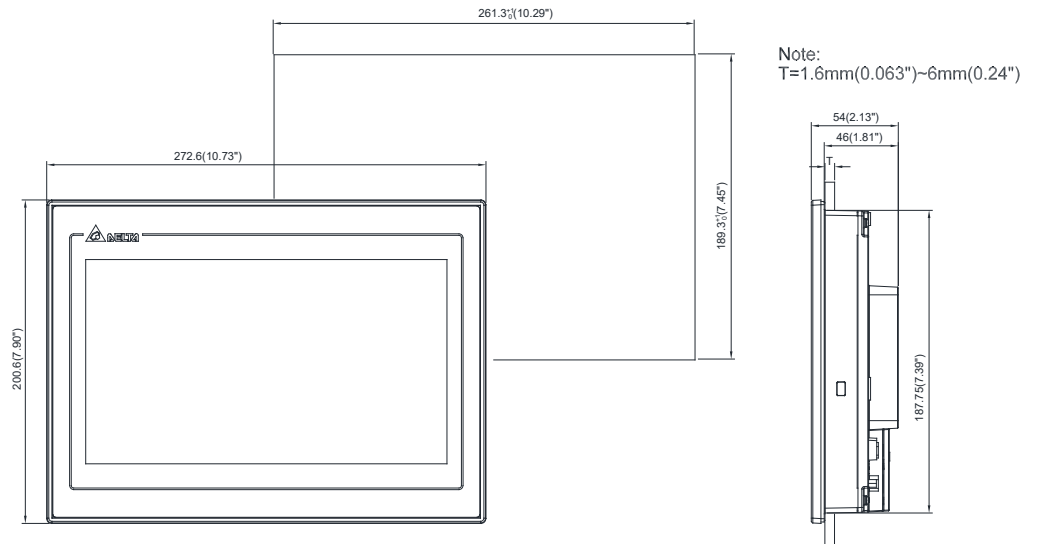

• DOP-110IG

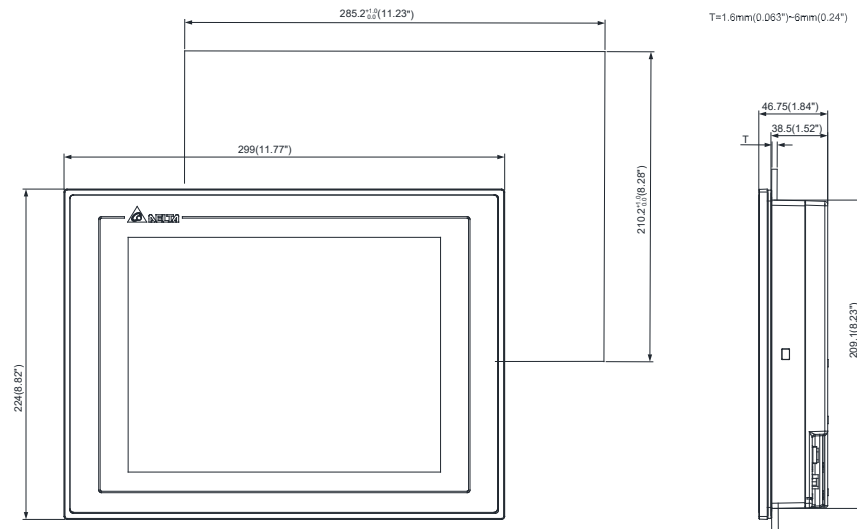

• DOP-107EV

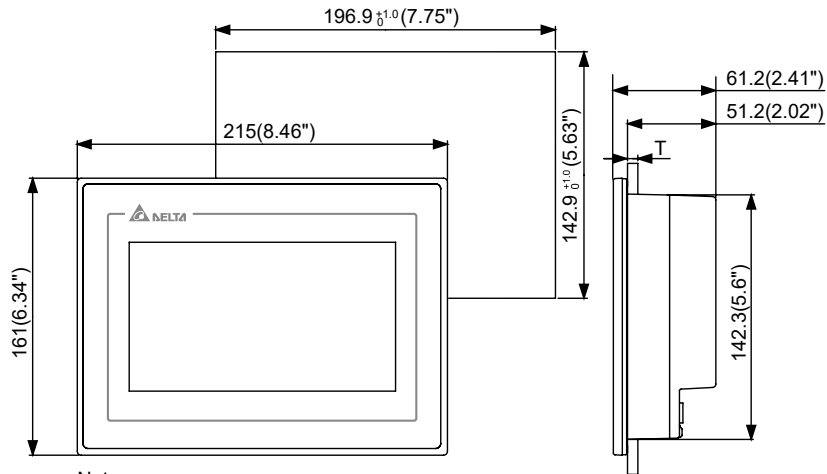

Note:
T=1.6 mm ~ 6 mm(0.063" ~ 0.24")

• DOP-107EG

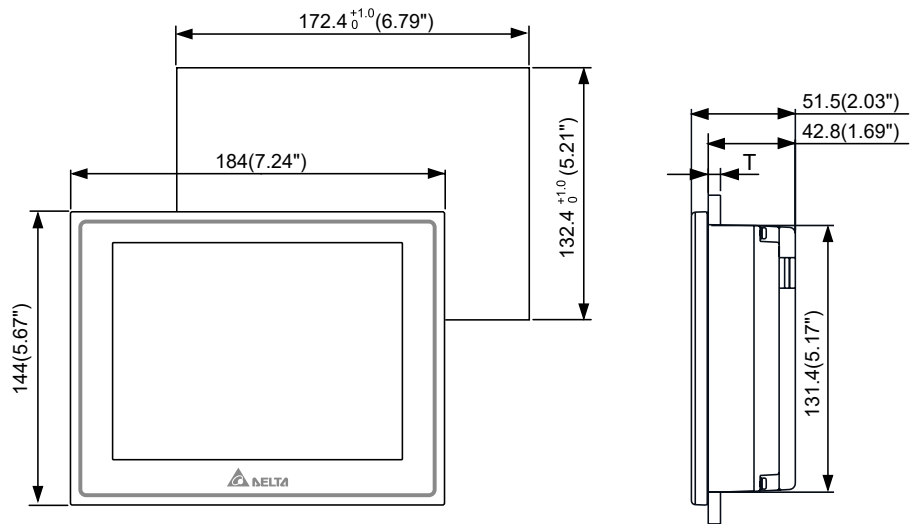

Note:
T=1.6 mm ~ 6 mm(0.063" ~ 0.24")

• DOP-105CQ

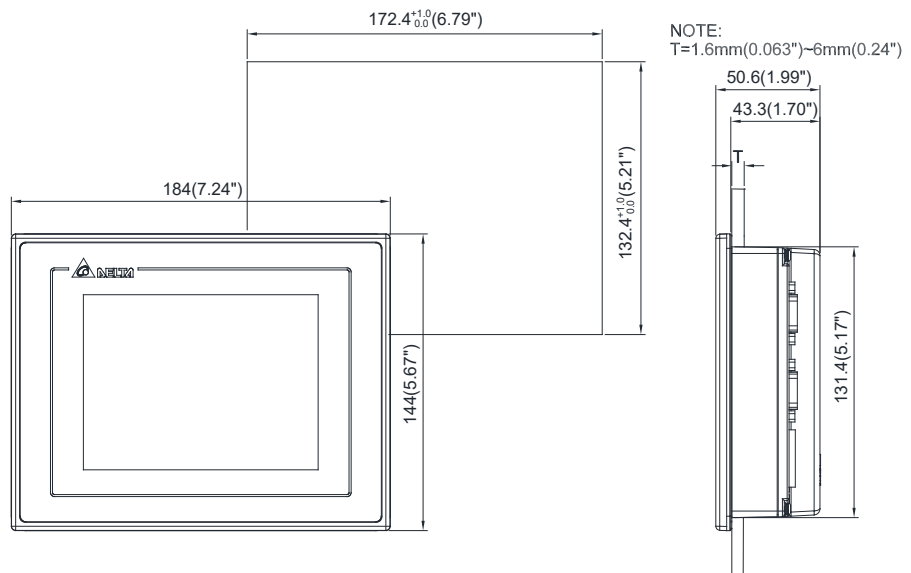

Dimensions Unit: mm (inches)

• DOP-107CV

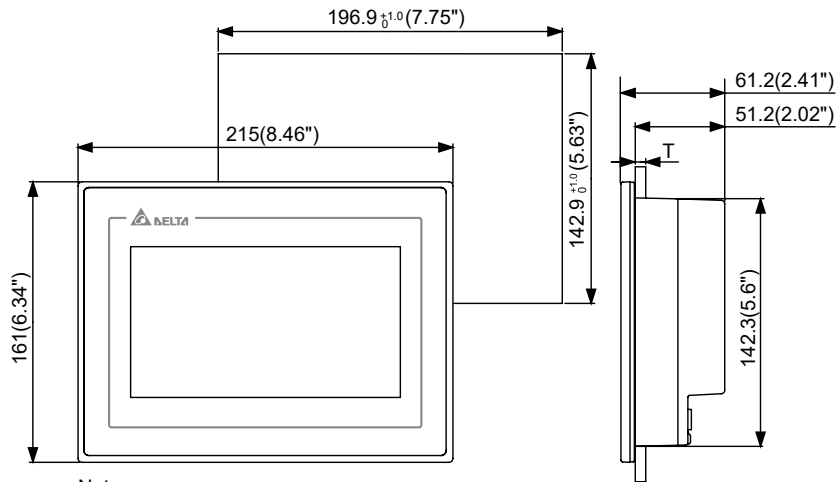

Note:
T=1.6 mm ~ 6 mm(0.063" ~ 0.24")

• DOP-110CS

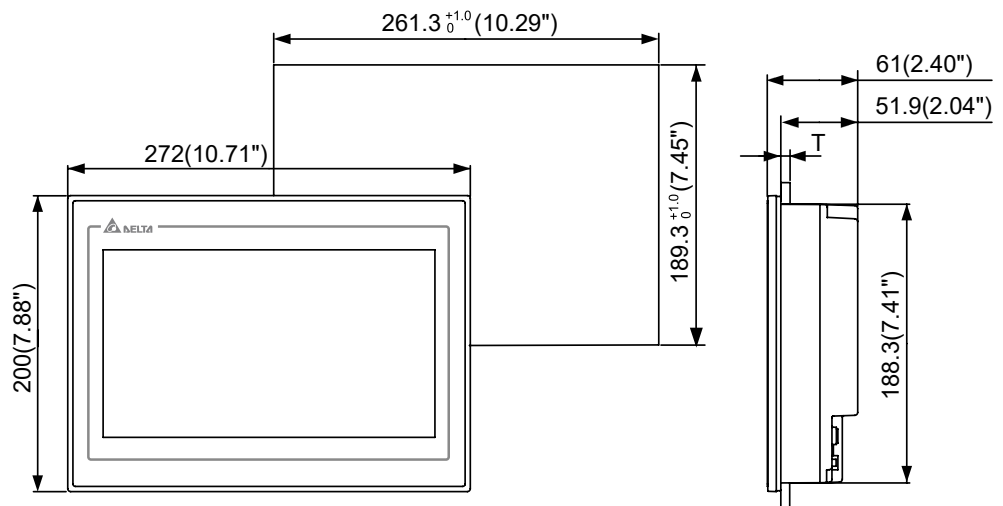

Note:
T=1.6 mm ~ 6 mm(0.063" ~ 0.24")

• DOP-110CG

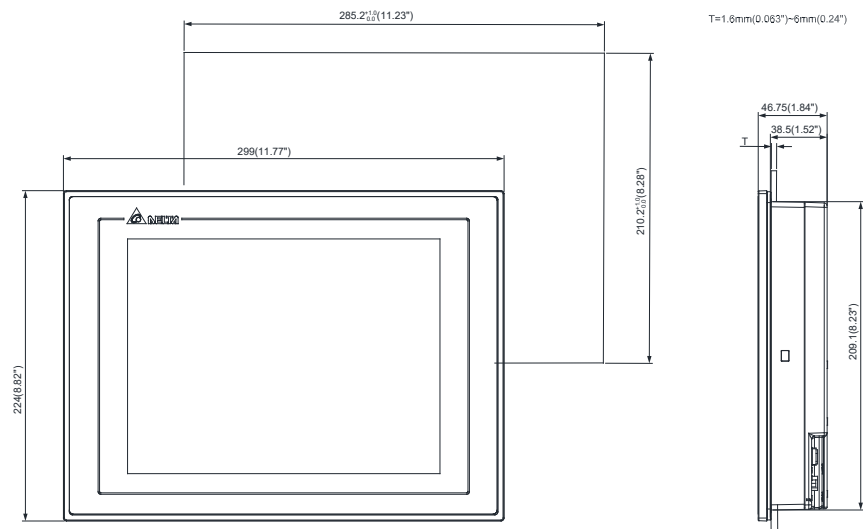

T=1.6mm(0.063")~6mm(0.24")

• DOP-107DV

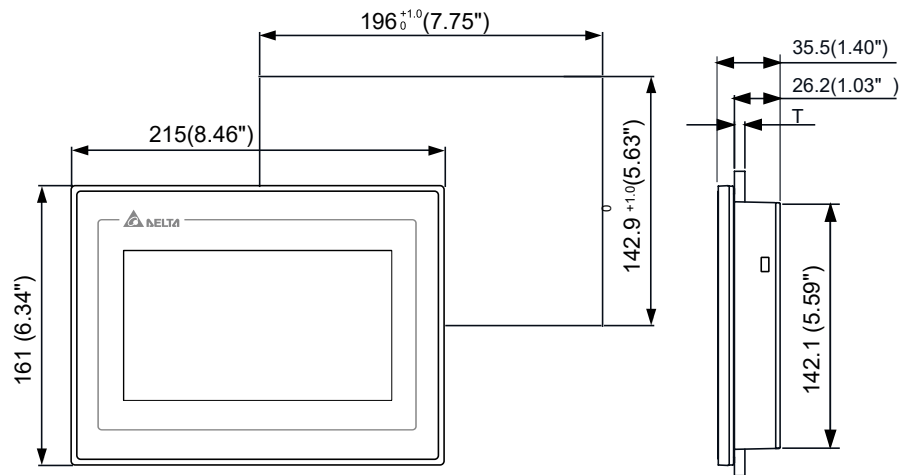

Note:
T=1.6 mm~6 mm(0.06"~0.24")

• DOP-103BQ

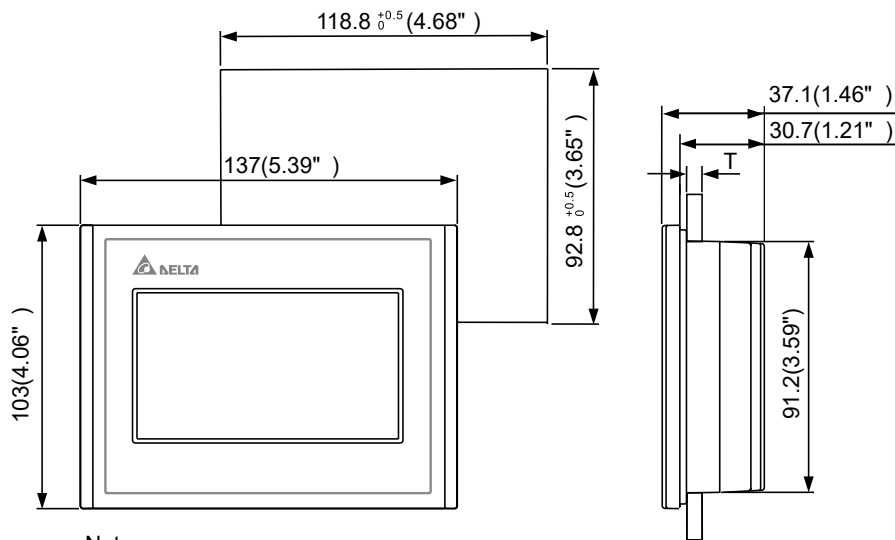

Note :
T=1.6mm~3mm(0.063"~0.12")

• DOP-107BV

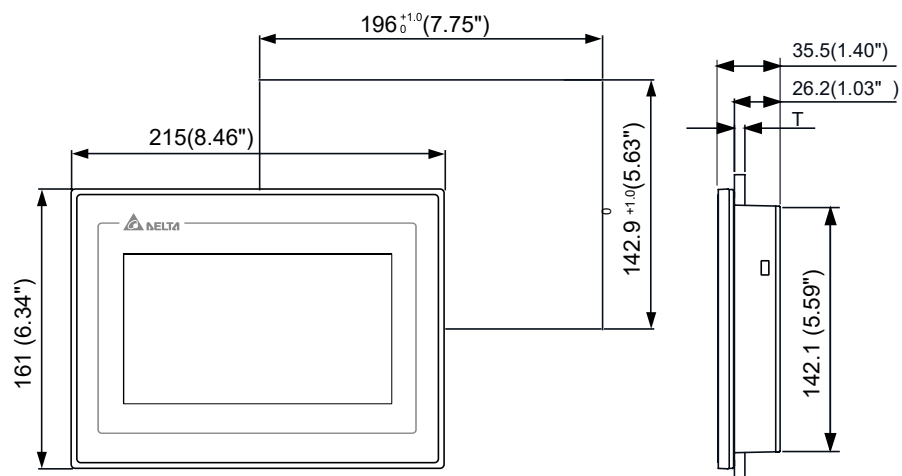

Note:
T=1.6 mm~6 mm(0.06"~0.24")

Global Operations

ASIA (Taiwan)



Taoyuan Technology Center (Green Building)



Taoyuan Plant 1



Tainan Plant (Diamond-rated Green Building)

ASIA (China)



Wujiang Plant 3



Delta Electronics



ASIA (Japan)



Tokyo Office



ASIA (India)



Rudrapur Plant
(Green Building)

EUROPE



Amsterdam, Netherlands

AMERICA



Research Triangle Park

▲ Factories 8 ■ Branch Offices 117 ● R&D Centers 13 ■ Distributors 915





Smarter. Greener. Together.

Industrial Automation Headquarters

Delta Electronics, Inc.

Taoyuan Technology Center
No.18, Xinglong Rd., Taoyuan District,
Taoyuan City 33068, Taiwan
TEL: 886-3-362-6301 / FAX: 886-3-371-6301

Asia

Delta Electronics (Shanghai) Co., Ltd.

No.182 Minyu Rd., Pudong Shanghai, P.R.C.
Post code : 201209
TEL: 86-21-6872-3988 / FAX: 86-21-6872-3996
Customer Service: 400-820-9595

Delta Electronics (Japan), Inc.

Tokyo Office
Industrial Automation Sales Department
2-1-14 Shibadaimon, Minato-ku
Tokyo, Japan 105-0012
TEL: 81-3-5733-1155 / FAX: 81-3-5733-1255

Delta Electronics (Korea), Inc.

Seoul Office
1511, 219, Gasan Digital 1-Ro., Geumcheon-gu,
Seoul, 08501 South Korea
TEL: 82-2-515-5305 / FAX: 82-2-515-5302

Delta Energy Systems (Singapore) Pte Ltd.

4 Kaki Bukit Avenue 1, #05-04, Singapore 417939
TEL: 65-6747-5155 / FAX: 65-6744-9228

Delta Electronics (India) Pvt. Ltd.

Plot No.43, Sector 35, HSIIDC Gurgaon,
PIN 122001, Haryana, India
TEL: 91-124-4874900 / FAX : 91-124-4874945

Delta Electronics (Thailand) PCL.

909 Soi 9, Moo 4, Bangpoo Industrial Estate (E.P.Z),
Pattana 1 Rd., T.Phraksa, A.Muang,
Samutprakarn 10280, Thailand
TEL: 66-2709-2800 / FAX : 662-709-2827

Delta Electronics (Australia) Pty Ltd.

Unit 20-21/45 Normanby Rd., Notting Hill Vic 3168, Australia
TEL: 61-3-9543-3720

Americas

Delta Electronics (Americas) Ltd.

Raleigh Office
P.O. Box 12173, 5101 Davis Drive,
Research Triangle Park, NC 27709, U.S.A.
TEL: 1-919-767-3813 / FAX: 1-919-767-3969

Delta Greentech (Brasil) S/A

São Paulo Office
Rua Itapeva, 26 – 3º Andar - Bela Vista
CEP: 01332-000 – São Paulo – SP - Brasil
TEL: 55-11-3530-8643 / 55-11-3530-8640

Delta Electronics International Mexico S.A. de C.V.

Mexico Office
Gustavo Baz No. 309 Edificio E PB 103
Colonia La Loma, CP 54060
Tlalnepantla, Estado de México
TEL: 52-55-3603-9200

EMEA

Headquarters: Delta Electronics (Netherlands) B.V.

Sales: Sales.IA.EMEA@deltaww.com
Marketing: Marketing.IA.EMEA@deltaww.com
Technical Support: iatechnicalsupport@deltaww.com
Customer Support: Customer-Support@deltaww.com
Service: Service.IA.emea@deltaww.com
TEL: +31(0)40 800 3900

BENELUX: Delta Electronics (Netherlands) B.V.

De Witbogt 20, 5652 AG Eindhoven, The Netherlands
Mail: Sales.IA.Benelux@deltaww.com
TEL: +31(0)40 800 3900

DACH: Delta Electronics (Netherlands) B.V.

Coesterweg 45, D-59494 Soest, Germany
Mail: Sales.IA.DACH@deltaww.com
TEL: +49(0)2921 987 0

France: Delta Electronics (France) S.A.

ZI du bois Challand 2, 15 rue des Pyrénées,
Lisses, 91090 Evry Cedex, France
Mail: Sales.IA.FR@deltaww.com
TEL: +33(0)1 69 77 82 60

Iberia: Delta Electronics Solutions (Spain) S.L.U

Ctra. De Villaverde a Vallecas, 265 1º Dcha Ed.
Hormigueras – P.I. de Vallecas 28031 Madrid
TEL: +34(0)91 223 74 20

Carrer Llacuna 166, 08018 Barcelona, Spain

Mail: Sales.IA.Iberia@deltaww.com

Italy: Delta Electronics (Italy) S.r.l.

Via Meda 2-22060 Novedrate(CO)
Piazza Grazioli 18 00186 Roma Italy
Mail: Sales.IA.Italy@deltaww.com
TEL: +39 039 8900365

Russia: Delta Energy System LLC

Vereyskaya Plaza II, office 112 Vereyskaya str.
17 121357 Moscow Russia
Mail: Sales.IA.RU@deltaww.com
TEL: +7 495 644 3240

Turkey: Delta Greentech Elektronik San. Ltd. Sti. (Turkey)

Şerifaii Mah. Hendem Cad. Kule Sok. No:16-A
34775 Ümraniye – İstanbul
Mail: Sales.IA.Turkey@deltaww.com
TEL: + 90 216 499 9910

GCC: Delta Energy Systems AG (Dubai BR)

P.O. Box 185668, Gate 7, 3rd Floor, Hamarain Centre
Dubai, United Arab Emirates
Mail: Sales.IA.MEA@deltaww.com
TEL: +971(0)4 2690148

Egypt + North Africa: Delta Electronics

Unit 318, 3rd Floor, Trivium Business Complex, North 90 street,
New Cairo, Cairo, Egypt
Mail: Sales.IA.MEA@deltaww.com