

DELTA ELECTRONICS, INC.
 252, SHANG YING ROAD, KUEI SAN
 TAoyUAN HSIEN 333, TAIWAN, R. O. C.

TEL : 886-(0)3-3591968
 FAX : 886-(0)3-3591991

SPECIFICATION FOR APPROVAL

Customer:

Description: DC FAN

Customer P/N: REV:

Delta Model NO.: EFB0612MA-F00

Sample Rev: 00 Issue NO:

Sample Issue Date: JAN.09.2006. Quantity:

1. SCOPE:

THIS SPECIFICATION DEFINES THE ELECTRICAL AND MECHANICAL CHARACTERISTICS OF THE DC BRUSHLESS AXIAL FLOW FAN. THE FAN MOTOR IS WITH TWO PHASES AND FOUR POLES.

2. CHARACTERS:

ITEM	DESCRIPTION
RATED VOLTAGE	12 VDC
OPERATION VOLTAGE	7.0 - 13.8 VDC
START VOLTAGE (ENVIRONMENT TEMPERATURE 25°C)	≤ 5.0 VDC
INPUT CURRENT	0.08 (MAX. 0.12) A
INPUT POWER	0.96 (MAX. 1.44) W
SPEED	3600 R.P.M. (REF.)
MAX. AIR FLOW (AT ZERO STATIC PRESSURE)	0.440 (MIN. 0.390) M ³ /MIN. 15.54 (MIN. 13.77) CFM
MAX. AIR PRESSURE (AT ZERO AIRFLOW)	2.40 (MIN. 1.94) mmH ₂ O 0.094 (MIN. 0.076) inchH ₂ O
ACOUSTICAL NOISE (AVG.)	29.0 (MAX. 33.0) dB-A
INSULATION TYPE	UL: CLASS A

(continued)

PART NO:

DELTA MODEL: EFB0612MA-F00

INSULATION STRENGTH	10 MEG OHM MIN. AT 500 VDC (BETWEEN FRAME AND (+) TERMINAL)
DIELECTRIC STRENGTH	5 mA MAX. AT 500 VAC 60 Hz ONE MINUTE, (BETWEEN FRAME AND (+) TERMINAL)
EXTERNAL COVER	OPEN TYPE
LIFE EXPECTANCE	70,000 HOURS CONTINUOUS OPERATION AT 40 °C WITH 15 ~ 65 %RH.
ROTATION	CLOCKWISE VIEW FROM NAME PLATE SIDE
OVER CURRENT SHUT DOWN	THE CURRENT WILL SHUT DOWN WHEN LOCKING ROTOR.
LEAD WIRE	UL 1007 -F- AWG #28 BLACK WIRE NEGATIVE(-) RED WIRE POSITIVE(+) BLUE WIRE FREQUENCY(-F00)

- NOTES: 1. ALL READINGS ARE MEASURED AFTER STABLY WARMING UP THROUGH 10 MINUTES.
2. THE VALUES WRITTEN IN PARENS , (), ARE LIMITED SPEC.
3. ACOUSTICAL NOISE MEASURING CONDITION:

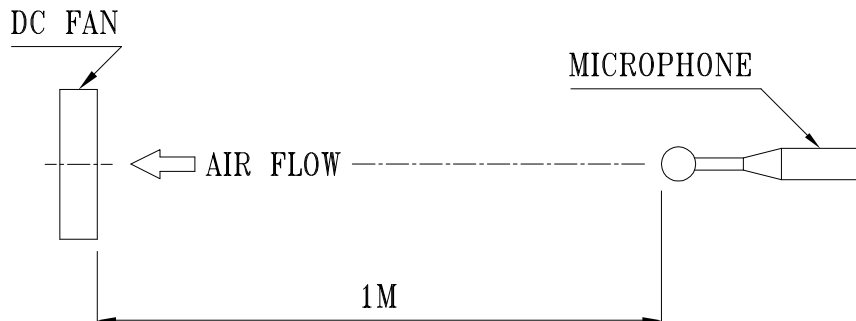

NOISE IS MEASURED AT RATED VOLTAGE IN FREE AIR IN ANECHOIC CHAMBER WITH B & K SOUND LEVEL METER WITH MICROPHONE AT A DISTANCE OF ONE METER FROM THE FAN INTAKE.

PART NO:

DELTA MODEL: EFB0612MA-F00

3. MECHANICAL:

- 3-1. DIMENSIONS ----- SEE DIMENSIONS DRAWING
- 3-2. FRAME ----- PLASTIC UL: 94V-0
- 3-3. IMPELLER ----- PLASTIC UL: 94V-0
- 3-4. BEARING SYSTEM ----- TWO BALL BEARINGS
- 3-5. WEIGHT ----- 28 GRAMS

4. ENVIRONMENTAL:

- 4-1. OPERATING TEMPERATURE ----- -10 TO +70 DEGREE C
- 4-2. STORAGE TEMPERATURE ----- -40 TO +75 DEGREE C
- 4-3. OPERATING HUMIDITY ----- 5 TO 90 % RH
- 4-4. STORAGE HUMIDITY ----- 5 TO 95 % RH

5. PROTECTION:

5-1. LOCKED ROTOR PROTECTION

IMPEDANCE OF MOTOR WINDING PROTECTS MOTOR FROM FIRE IN 96 HOURS OF LOCKED ROTOR CONDITION AT THE RATED VOLTAGE.

5-2. POLARITY PROTECTION

BE CAPABLE OF WITHSTANDING IF REVERSE CONNECTION FOR POSITIVE AND NEGATIVE LEADS.

6. RE OZONE DEPLETING SUBSTANCES:

- 6-1. NO CONTAINING PBBs, PBB0s, CFCs, PBBEs, PBDPEs AND HCFCs.

7. PRODUCTION LOCATION

- 7-1. PRODUCTS WILL BE PRODUCED IN CHINA OR THAILAND OR TAIWAN.

PART NO:

DELTA MODEL: EFB0612MA-F00

8. BASIC RELIABILITY REQUIREMENT:

- 8-1. THERMAL CYCLING LOW TEMPERATURE: -40°C
 HIGH TEMPERATURE: +80°C
 SOAK TIME: 30 MINUTES
 TRANSITION TIME < 5 MINUTES
 DUTY CYCLES: 5
- 8-2. HUMIDITY EXPOSURE TEMPERATURE: +25°C ~ +65°C
 HUMIDITY: 90-98% RH @ +65°C
 FOR 4 HOURS/CYCLE
 POWER: NON-OPERATING
 TEST TIME: 168 HOURS
- 8-3. VIBRATION TEMPERATURE: +25°C
 ORIENTATION: X, Y, Z
 POWER: NON-OPERATING
 VIBRATION LEVEL: OVERALL gRMS=3.2
- | FREQUENCY(Hz) | PSD(G^2/Hz) |
|---------------|-----------------|
| 10 | 0.040 |
| 20 | 0.100 |
| 40 | 0.100 |
| 800 | 0.002 |
| 1000 | 0.002 |
- TEST TIME: 2 HOURS ON EACH ORIENTATION
- 8-4. MECHANICAL SHOCK TEMPERATURE: +20°C
 ORIENTATION: X, Y, Z
 POWER: NON-OPERATING
 ACCELERATION: 20 G MIN.
 PULSE: 11 ms HALF-SINE WAVE
 NUMBER OF SHOCKS: 5 SHOCKS
 FOR EACH DIRECTION
- 8-5. LIFE TEMPERATURE: MAX , OPERATING TEMPERATURE
 POWER: OPERATING
 DURATION: 1000 HOURS MIN.

PART NO:

DELTA MODEL: EFB0612MA-F00

9. P & Q CURVE:

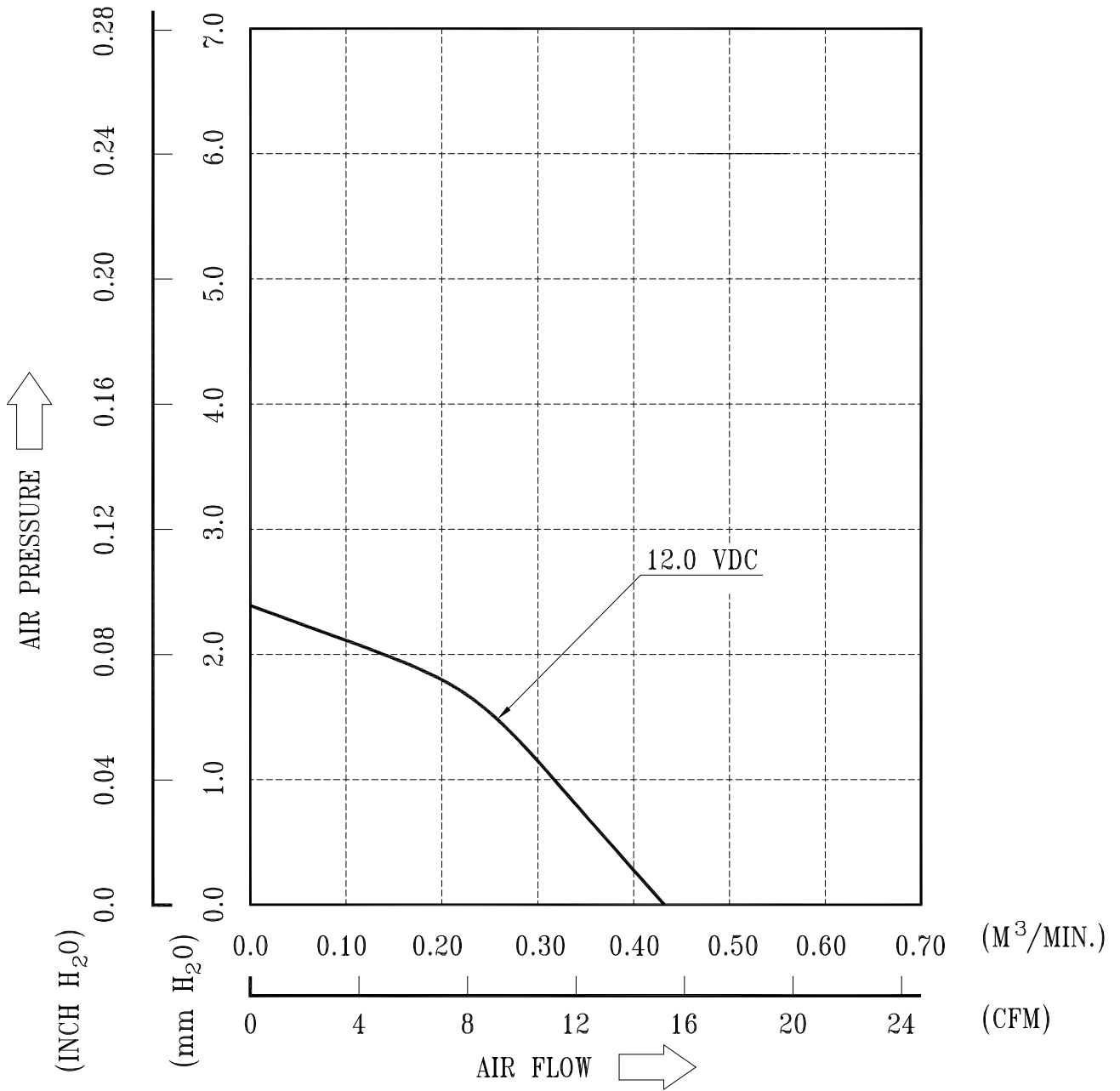

* TEST CONDITION: INPUT VOLTAGE ----- OPERATION VOLTAGE
TEMPERATURE ----- ROOM TEMPERATURE
HUMIDITY ----- 65%RH

PART NO:

DELTA MODEL: EFB0612MA-F00

10. DIMENSION DRAWING:

LABEL:

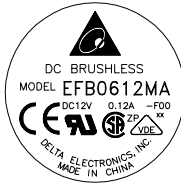

OR



OR

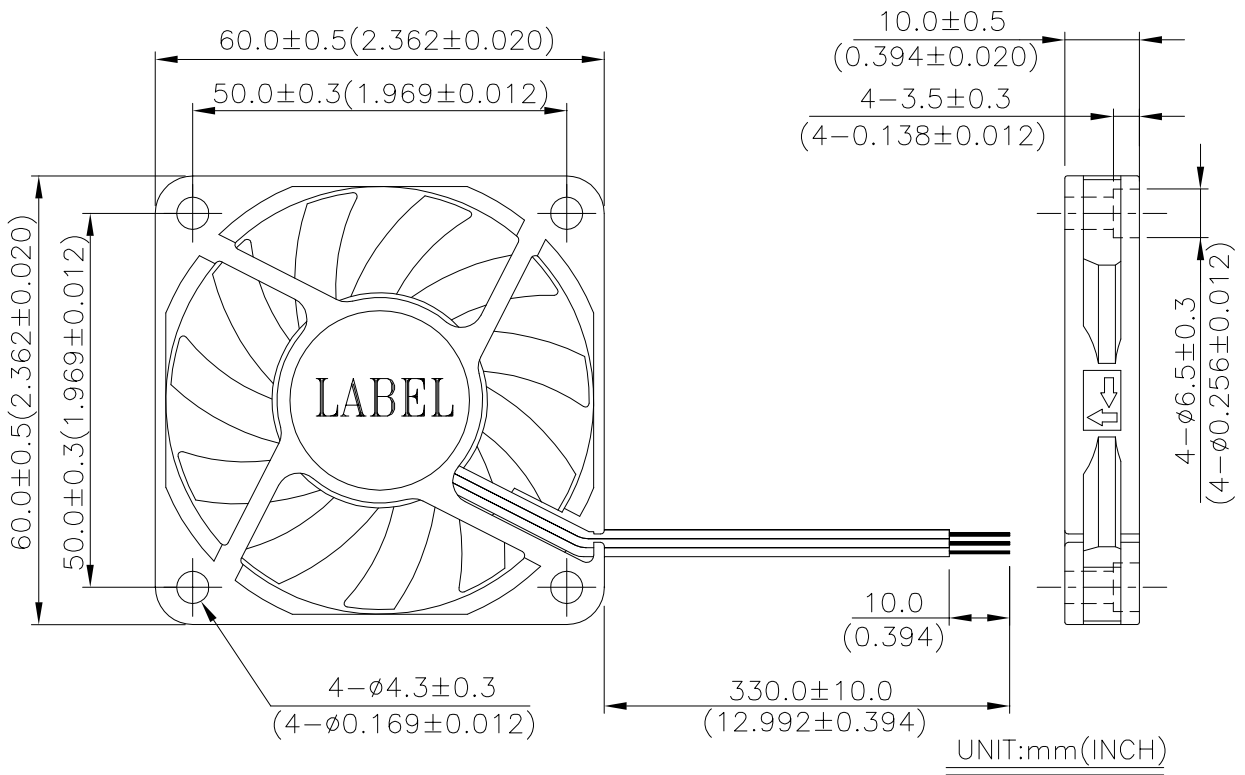
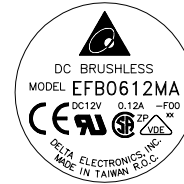

PART NO:

DELTA MODEL: EFB0612MA-F00

11. FREQUENCY GENERATOR (FG) SIGNAL:

1. OUTPUT CIRCUIT - OPEN COLLECTOR MODE:

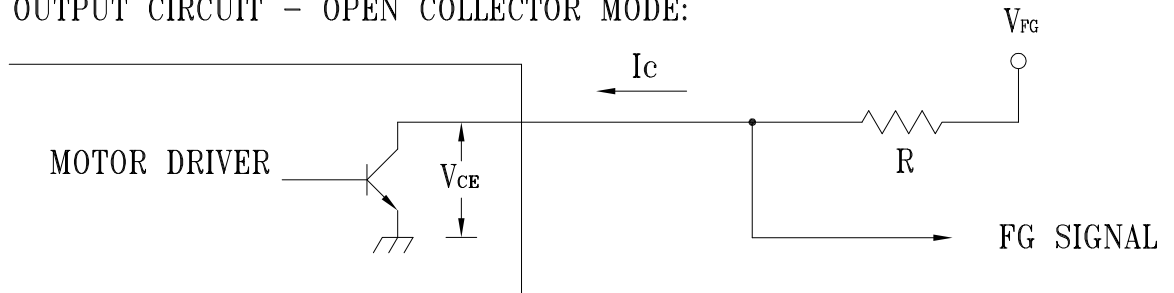

CAUTION:

THE LEAD WIRE OF FG SIGNAL CAN NOT TOUCH
THE LEAD WIRE OF POSITIVE OR NEGATIVE.

2. SPECIFICATION:

$V_{ce}(\text{sat}) = 0.5\text{V MAX.}$

$V_{FG} = 15\text{VDC MAX.}$

$I_c = 5\text{mA MAX.}$

$R \geq V_{FG}/I_c$

3. FREQUENCY GENERATOR WAVEFORM:

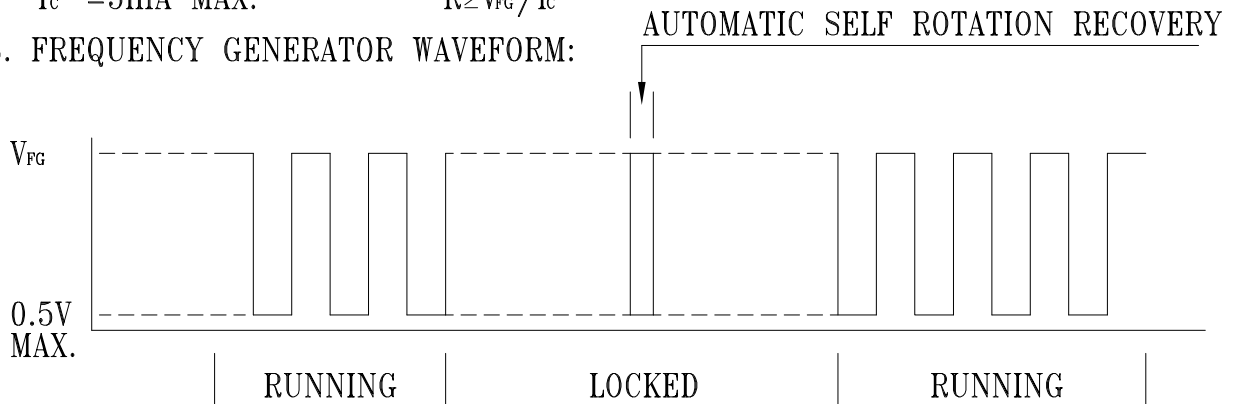

FAN RUNNING FOR 4 POLES

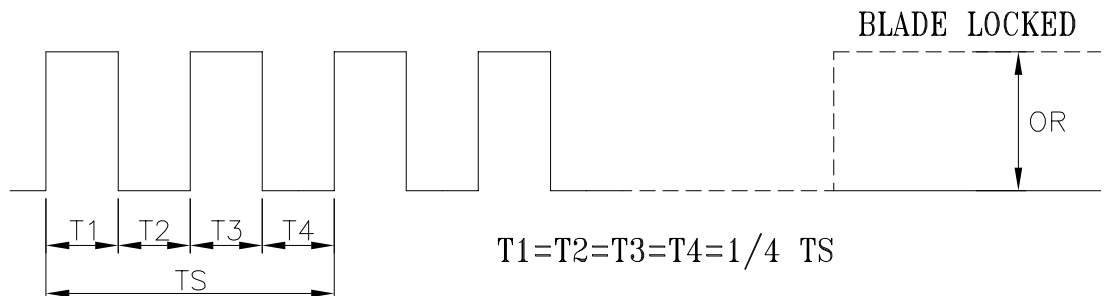

$N = \text{R.P.M}$

$T_S = 60/N(\text{SEC})$

*VOLTAGE LEVEL AFTER BLADE LOCKED

*4 POLES

page: 7

A00



Descriptions:

- 1. Delta will not guarantee the performance of the products if the application condition falls outside the parameters set forth in the specification.**
- 2. A written request should be submitted to Delta prior to approval if deviation from this specification is required.**
- 3. Please exercise caution when handling fans. Damage may be caused when pressure is applied to the impeller, if the fans are handled by the lead wires, or if the fans are hard-dropped to the production floor.**
- 4. Except as pertains to some special designs, there is no guarantee that the products will be free from any such safety problems or failures as caused by the introduction of powder, droplets of water or encroachment of insect into the hub.**
- 5. The above-mentioned conditions are representative of some unique examples and viewed as the first point of reference prior to all other information.**
- 6. It is very important to establish the correct polarity before connecting the fan to the power source. Positive (+) and Negative (-). Damage may be caused to the fans if connection is with reverse polarity, as there is no foolproof method to protect against such error.**
- 7. Delta fans are not suitable where any corrosive fluids are introduced to their environment.**
- 8. Please ensure all fans are stored according to the storage temperature limits specified. Do not store fans in a high humidity environment. We highly recommend performance testing is conducted before shipping, if the fans have been stored over 6 months.**
- 9. Not all fans are provided with the Lock Rotor Protection feature. If you impair the rotation of the impeller for the fans that do not have this function, the performance of those fans will lead to failure.**
- 10. Please be cautious when mounting the fan. Incorrect mounting of fans may cause excess resonance, vibration and subsequent noise.**
- 11. It is important to consider safety when testing the fans. A suitable fan guard should be fitted to the fan to guard against any potential for personal injury.**
- 12. Except where specifically stated, all tests are carried out at relative (ambient) temperature and humidity conditions of 25°C, 65%. The test value is only for fan performance itself.**
- 13. Be certain to connect an “over 4.7µF” capacitor to the fan externally when the application calls for using multiple fans in parallel, to avoid any unstable power.**

WFB followed by 1212, followed by ME; Model WFB followed by 1212, 1224 or 1248, followed by VHE; Model WFB followed by 1248, followed by HHE.

Model EFB followed by 0912 or 0924, followed by H, HH, L, M, SH or VH.

Model WFB followed by 1212 or 1224, followed by H, HE, HH, HHE, L, LE, M or ME; Model WFB followed by 1248, followed by HE, LE or ME; Model WFC followed by 1212, 1212, followed by B or BE.

Model BFB followed by 1212, 1224 followed by HE.

Model BFB followed by 0305, 03505, followed by HP, LP, MP.

Model AFB or ASB followed by 0505 or 0512, followed by HA, LA or MA.

Model BFB followed by 0712, 0724, followed by H, L, M.

Model BFC followed by 1212, followed by A, B; Models BFC1212C, BFC1224C, BFC1248C.

Model EFB followed by 0512, followed by HHA, HA, LA or MA, and EFB0505HA, EFB0505MA, EFB0505LA, followed by FOO or STD.; Model EFB followed by 0505, followed by HA, LA or MA, followed by FOO or STD.

Model AFC followed by 0512, 0612, 0712, 0812, 0824, 0912 or 0924, followed by "A", "AB", "AD", "B", "BB", "BD" or "C"; Model AFC followed by 0912, followed by "A" or "B", followed by -(H), -(HH), -(M); Model ASC followed by 0612, 0812, 0912 followed by "A" or "B".

Model ASB followed by 0605, followed by H, L, M; Model ASB followed by 0612, followed by H-SB, L-SB or M-SB; Model ASB followed by 0812 or 0824, followed by H, HH, L, LL or M; Model ASB followed by 0912, 0924, followed by H, HH, L, L-V, M; Model ASB followed by 0924 followed by H, HH, L or M, Model ASB0812L-SB, H-SB or M-SB; Model ASB0912L-SB, H-SB or M-SB; Model DSB followed by 0612, 0812, followed by H, H-N, L, L-N, M, M-N.

Model AFB followed by 0612, followed by H, HH, L, M, followed by SB; Model AFB followed by 0812, followed by H, L or M, followed by SB; Model AFB followed by 0912, followed by H, L or M, followed by SB.

Model AFB followed by 1212, followed by HE, HHE, LE, ME, SHE VHE; Model AFB followed by 1224, followed by HE, HHE, LE, ME, SHE, VHE; Model AFB followed by 1248, followed by HE, HHE, LE, ME, VHE; Model EFB followed by 1212, followed by HE, HHE, LE, ME, SHE, VHE; Model EFB followed by 1224, followed by HE, HHE, LE, ME, SHE, VHE; Model EFB followed by 1248, followed by HE, HHE, LE, ME, SHE, VHE.

Model BFB followed by 1012, followed by H, HH, L, LL or M; Model BFB followed by 1024, followed by H, HH, L, LL or M; Model BFB followed by 1212, followed by H, HH, L, LL, M or VH; Model BFB followed by 1224, followed by H, HH, L, LL or M; Model BFB followed by 1248, followed by H, HH, L, LL or M.

Model BFB followed by 1212, 1224, followed by HE, HHE, LE, ME or VH; Model BFB followed by 1248, followed by HE, LE or ME; Model BFB followed by 1612, followed by H, L or M; Model BFB followed by 1624, followed by H, L or M; Model BFB followed by 1648, followed by H, L or M.

Models BFB0405HE, -LE, -ME, BFB0412HE, -HHE, -LE, -ME.

Models AUB0812H, -HH, -L, -LB, -M, -SHB, -VH, AUB0824H, -HH, -L, -LB, -M, -SHB, -VH.

Model BFB followed by 0505, 0512, 0524, followed by H, HH, L or M; Model BSB followed by 0505, 0512, 0524, followed by H, HH, L or M.

Models EFB1212 -H, -HF, -HH, -HHE, -L, -LE, -M, -ME, -SH, -VH, -VHE, EFB1224 -H, -HE, -HH, -HHE, -L, -LE, -M, -ME, -SH, -VH, -VHE, EFB1248 -H, -HH, -L, -M, -SH, -VH.

Model EFB followed by 0405, followed by HD, HHD, LD, LLD, MD VHD; Model EFB followed by 0412, followed by HD, HHD, LD, LLD, MD, VHD, MD, VHD; Model EFB followed by 0424, followed by HD, HHD, LD, LLD, MD, VHD.

Models BFB0305HA, -HHA, -LA, -MA, BFB0312HA, -HHA, -LA, -MA.

Models AFB1512H, -L, -M, AFB1548H, -L, -M, AFB1712H, -L, -M, AFB1748H, -L, -M, EFB1248HE, -HHE, -LE, -ME, -VHE, EFB1548HG, -HHG, -LG, -MG, -VHG, EFB1748HG, -HHG, -LG, -MG, -VHG.

Models AFB0305LK, -MK, -HK, AFB0405LK, -MK, -HK.

Model BFB03505 followed by HR, LR, MR; Model BFB03505 followed by HA, HHA, LA, MA; Model BFB03512 followed by HA, HHA, LA, MA.

Models AFB02505LB, -MB, -HB, -HHE.

Model SFB followed by 0112, followed by H, HH, M or VH; Model SUB followed by 0112, 0212, followed by H, HH, M or VH.

Model EFB followed by 1512, 1712, followed by HG, HHG, LG, MG; Model EFB followed by 1524, 1724, followed by HG, HHG, LG, MG, SHG or VHG.

Model EFB followed by 0912, 0924, followed by HE, HHE, LE or ME.

Model FFB followed by 0848, followed by SHE; Model FFB followed by 0912 or 0924, followed by EHE, HHE, SHE or VHE; Model FFB followed by 0948, followed by HHE, SHE or VHE; Model FFB followed by 1212 or 1224, followed by EHE, HE, HHE, SHE or VHE; Model FFB followed by 1248, followed by EHE, SHE or VHE.

Model EFC followed by 1212 or 1224, followed by DE; Model EFC0412 followed by AD or BD.

Model BFB followed by 0405, 0412, 04505, 04512, 0505 or 0512, followed by HA, HHA, LA or MA.

Model EUB followed by 0405, 0412 or 0424, followed by HD, HHD, LD, LLD or MD; Model EUB followed by 0412 or 0424, followed by VHD.

Model ASB followed by 0605, followed by HB, HHB, LB or MB; Model ASB followed by 0612 or 0624, followed by HB, HHB, LB, MB or VHB; Model AUB followed by 0605, followed by HB, HHB, LB or MB; Model AUB followed by 0612 or 0624, followed by HB, HHB, LB, MB or VHB.

Model AFB followed by 1524, 1724, followed by H, HH, L or M; Model EFC followed by 1248, followed by EE; Model FFB followed by 0812, 0824, followed by HHE, SHE or VHE; Model FFB0848 followed by HHE, VHE or SHE.

Model BFB followed by 0405, 0505 or 04505, followed by HP, LP or MP.

Model EFB followed by 0612, followed by HA, HHA, LA or MA.

Model AUB followed by 0612, 0624 or 0648, followed by EH, SH or VH.

Model EFB followed by 0812 or 0824, followed by HE, HHE, LE or ME.

Model ASB followed by 0605, followed by HD, HHD, LD or MD; Model ASB followed by 0612 or 0624, followed by HD, HHD, LD, MD or VHD; Model AUB followed by 0605, 0612 or 0624, followed by HD, HHD, LD or MD; Model AUB followed by 0612 or 0624, followed by VHD.

Model EFB followed by 0912 or 0924, followed by HF, HHE, LF, MF, SHF or VHE.

Model EFB followed by 1312 or 1324, followed by HE, HHE, LE, ME, SHE or VHE; Model EFB followed by 1348, followed by HE, HHE, LE, ME or VHE.

Model ASB followed by 0712 or 0724, followed by H, HH, L, M or VH; Model AUB followed by 0712 or 0724, followed by H, HH, L, M or VH.

Model EFB followed by 0812 or 0824, followed by EHE, HF, HHE, LF, MF, SHF or VHE.

Model EFC followed by 0912, followed by AE or BE.

Model HFB followed by 0605, 0612 or 0624, followed by HB, HD, HHB, HHD, LB, LD, MB or MD.

Model AFB followed by 1212 or 1224, followed by H, HH, L, M, SH or VH.

Model KFB followed by 03205, followed by HP, LP or MP; Model KFB followed by 03205, followed by HA, LA or MA.

EFB0512LA	12	80	-
EFB0512MA	12	120	-
EFB0512HA	12	150	-
EFB0612LA	12	110	STD R00 F00
EFB0612MA	12	120	STD R00 F00
EFB0612HA	12	180	STD R00 F00
EFB0612HHA	12	250	STD R00 F00
EFB0812HE	12	480	STD R00 F00
EFB0812HHE	12	620	STD R00 F00
EFB0812LE	12	230	STD R00 F00
EFB0812ME	12	330	STD R00 F00
EFB0812LF	12	150	-
EFB0812MF	12	210	-
EFB0812HF	12	260	-
EFB0812HHF	12	320	-
EFB0812VHF	12	390	-
EFB0812SHF	12	510	-
EFB0812EHF	12	680	-
EFB0824HE	24	230	STD R00 F00
EFB0824HHE	24	270	STD R00 F00
EFB0824LE	24	110	STD R00 F00
EFB0824ME	24	170	STD R00 F00
EFB0824LF	24	80	-
EFB0824MF	24	110	-

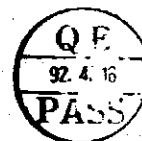

VDE Prüf- und Zertifizierungsinstitut Gutachten mit Fertigungsüberwachung

Ausweis-Nr. / Blatt /
Licence No. / page
1764 / 10

Name und Sitz des Genehmigungs-Inhabers / *Name and registered seat of the Licence holder*
Delta Electronics Inc., 186 Ruey Kuang Road, NEIHU TAIPEI (114), TAIWAN

Aktenzeichen / *File ref.*
1164100-2611-0001 / 11826 / F131 / S

letzte Änderung / *updated* Datum / *Date*
2002-02-26 1994-06-08

Dieses Blatt gilt nur in Verbindung mit Blatt 1 des Gutachtens mit Fertigungsüberwachung Nr. 1764.
This supplement is only valid in conjunction with page 1 of the Certificate of Conformity with factory surveillance No. 1764.

Jahresgebühren-Einheiten /
Annual fee units

EFB0612LA/MA/HA/HHA	DC 12V	2,00
EFB0812LE/ME/HE/HHE	DC 12V	2,00
EFB0824LE/ME/HE/HHE	DC 24V	2,00
AUB0812LLB/LB/MB/HB/HHB/VHB/SHB	DC 12V	4,00
AUB0824LLB/LB/MB/HB/HHB/VHB/SHB	DC 24V	4,00
EFB0505LA/MA/HA	DC 5V	2,00
EFB0512LA/MA/HA/HHA	DC 12V	2,00

Nennspannung
Rated voltage min. DC 5 V
max. DC 48 V

Nennstrom
Rated current siehe Anlagen zum Ausweis Nr. 1764 ÜG
see Appendices to Licence No. 1764 ÜG

Umgebungstemperatur
Ambient temperature min. 25 °C
max. 80 °C
(siehe Anlagen zum Ausweis Nr. 1764 ÜG)
(see Appendices to Licence No. 1764 ÜG)

Schutzmassnahme
Protection against electric shock Schutzklasse III
Protection class III

Schutzart
Degree of protection Einbauteil für Geräte der Informationstechnik
Component for IT equipment

Einbaubedingungen
Built-in requirements Beim Einbau des genehmigten Erzeugnisses, der entsprechend der zugehörigen Installationsanleitung zu erfolgen hat, ist darauf zu achten, daß alle Anforderungen gemäß der oben genannten Bestimmung(en) eingehalten sind.
When the certified product is built in, the installation must be in accordance with the provided installation instructions and the requirements of the referenced standard(s) have to be met.

Weitere Angaben
Further information siehe Anlagen Nr. 1 - 148 zum Ausweis Nr. 1764 ÜG
see Appendices No. 1 - 148 to Licence No. 1764 ÜG

Fortsetzung siehe Blatt 11 /
continued on page 11

