

DTM64460C

8GB - 240-Pin 1Rx4 Registered ECC DDR3 DIMM



Identification

DTM64460C 1Gx72
8GB 1Rx4 PC3-14900R-13-12-C2

Performance range

Clock / Module Speed / CL-t_{RCD}-t_{RP}

933 MHz / PC3-14900 / 13-13-13
800 MHz / PC3-12800 / 11-11-11
667 MHz / PC3-10600 / 10-10-10
667 MHz / PC3-10600 / 9-9-9
533 MHz / PC3-8500 / 8-8-8
533 MHz / PC3-8500 / 7-7-7
400 MHz / PC3-6400 / 6-6-6

Features

240-pin JEDEC-compliant DIMM, 133.35 mm wide by 30 mm high

Operating Voltage: 1.5V ± 0.075

I/O Type: SSTL_15

On-board I2C temperature sensor with integrated serial presence-detect (SPD) EEPROM

Data Transfer Rate: 14.9 Gigabytes/sec

Data Bursts: 8 and burst chop 4 mode

ZQ Calibration for Output Driver and On-Die Termination (ODT)

Programmable ODT / Dynamic ODT during Writes

Programmable CAS Latency: 6, 7, 8, 9, 10, 11 and 13

Bi-Directional Differential Data Strobe signals

SDRAM Addressing (Row/Col/Bank): 16/11/3

Fully RoHS Compliant

Description

DTM64460C is a registered 1Gx72 memory module, which conforms to JEDEC's DDR3, PC3-14900 standard. The assembly is a Single-Rank containing: eighteen Samsung 1Gx4 DDR3 SDRAMs. One 2K-bit EEPROM is used for Serial Presence Detect and a combination register/PLL, with Address and Command Parity, is also used.

Both output driver strength and input termination impedance are programmable to maintain signal integrity on the I/O signals in a Fly-by topology.

A thermal sensor accurately monitors the DIMM module and can prevent exceeding the maximum operating temperature of 95C.

Pin Configuration

Front Side				Back Side				Pin Description	
								Name	Function
1 V _{REFDQ}	31 DQ25	61 A2	91 DQ41	121 V _{SS}	151 V _{SS}	181 A1	211 V _{SS}	CB[7:0]	Data Check Bits
2 V _{SS}	32 V _{SS}	62 V _{DD}	92 V _{SS}	122 DQ4	152 DQS12	182 V _{DD}	212 DQS14	DQ[63:0]	Data Bits
3 DQ0	33 /DQS3	63 CK1*	93 /DQS5	123 DQ5	153 /DQS12	183 V _{DD}	213 /DQS12	DQS[17:0], /DQS[17:0]	Differential Data Strobes
4 DQ1	34 DQS3	64 /CK1*	94 DQS5	124 V _{SS}	154 V _{SS}	184 CK0	214 V _{SS}	CK[1:0], /CK[1:0]	Differential Clock Inputs
5 V _{SS}	35 V _{SS}	65 V _{DD}	95 V _{SS}	125 DQS9	155 DQ30	185 /CK0	215 DQ46	CKE[1:0]	Clock Enables
6 /DQS0	36 DQ26	66 V _{DD}	96 DQ42	126 /DQS9	156 DQ31	186 V _{DD}	216 DQ47	/CAS	Column Address Strobe
7 DQS0	37 DQ27	67 V _{REFCA}	97 DQ43	127 V _{SS}	157 V _{SS}	187 /Event	217 V _{SS}	/RAS	Row Address Strobe
8 V _{SS}	38 V _{SS}	68 P _{AR_IN}	98 V _{SS}	128 DQ6	158 CB4	188 A0	218 DQ52	/S[3:0]	Chip Selects
9 DQ2	39 CB0	69 VDD	99 DQ48	129 DQ7	159 CB5	189 V _{DD}	219 DQ53	/WE	Write Enable
10 DQ3	40 CB1	70 A10/AP	100 DQ49	130 V _{SS}	160 V _{SS}	190 BA1	220 V _{SS}	A[15:0]	Address Inputs
11 V _{SS}	41 V _{SS}	71 BA0	101 V _{SS}	131 DQ12	161 DQS17	191 V _{DD}	221 DQS15	BA[2:0]	Bank Addresses
12 DQ8	42 /DQS8	72 V _{DD}	102 /DQS6	132 DQ13	162 /DQS17	192 /RAS	222 /DQS15	ODT[1:0]	On Die Termination Inputs
13 DQ9	43 DQS8	73 /WE	103 DQS6	133 V _{SS}	163 V _{SS}	193 /S0	223 V _{SS}	SA[2:0]	SPD Address
14 V _{SS}	44 V _{SS}	74 /CAS	104 V _{SS}	134 DQS10	164 CB6	194 V _{DD}	224 DQ54	SCL	SPD Clock Input
15 /DQS1	45 CB2	75 V _{DD}	105 DQ50	135 /DQS10	165 CB7	195 ODT0	225 DQ55	SDA	SPD Data Input/Output
16 DQS1	46 CB3	76 /S1	106 DQ51	136 V _{SS}	166 V _{SS}	196 A13	226 V _{SS}	V _{SS}	Ground
17 V _{SS}	47 V _{SS}	77 ODT1	107 V _{SS}	137 DQ14	167 NC (TEST)	197 V _{DD}	227 DQ60	V _{DD}	Power
18 DQ10	48 V _{TT}	78 V _{DD}	108 DQ56	138 DQ15	168 /RESET	198 /S3, NC*	228 DQ61	V _{DDSPD}	SPD EEPROM Power
19 DQ11	49 V _{TT}	79 /S2, NC*	109 DQ57	139 V _{SS}	169 CKE1	199 V _{SS}	229 V _{SS}	V _{REFDQ}	Reference Voltage for DQ
20 V _{SS}	50 CKE0	80 V _{SS}	110 V _{SS}	140 DQ20	170 V _{DD}	200 DQ36	230 DQS16	V _{REFCA}	Reference Voltage for CA
21 DQ16	51 V _{DD}	81 DQ32	111 /DQS7	141 DQ21	171 A15	201 DQ37	231 /DQS16	V _{TT}	Termination Voltage
22 DQ17	52 BA2	82 DQ33	112 DQS7	142 V _{SS}	172 A14	202 V _{SS}	232 V _{SS}	/Event	Temperature Sensing
23 V _{SS}	53 /E _{RR_OUT}	83 V _{SS}	113 V _{SS}	143 DQS11	173 V _{DD}	203 DQS13	233 DQ62	NC	No Connection
24 /DQS2	54 V _{DD}	84 /DQS4	114 DQ58	144 /DQS11	174 A12 /BC	204 /DQS13	234 DQ63		
25 DQS2	55 A11	85 DQS4	115 DQ59	145 V _{SS}	175 A9	205 V _{SS}	235 V _{SS}		
26 V _{SS}	56 A7	86 V _{SS}	116 V _{SS}	146 DQ22	176 V _{DD}	206 DQ38	236 V _{DDSPD}		
27 DQ18	57 V _{DD}	87 DQ34	117 SA0	147 DQ23	177 A8	207 DQ39	237 SA1		
28 DQ19	58 A5	88 DQ35	118 SCL	148 V _{SS}	178 A6	208 V _{SS}	238 SDA		
29 V _{SS}	59 A4	89 V _{SS}	119 SA2	149 DQ28	179 V _{DD}	209 DQ44	239 V _{SS}		
30 DQ24	60 V _{DD}	90 DQ40	120 V _{TT}	150 DQ29	180 A3	210 DQ45	240 V _{TT}		

* Not used

Front view

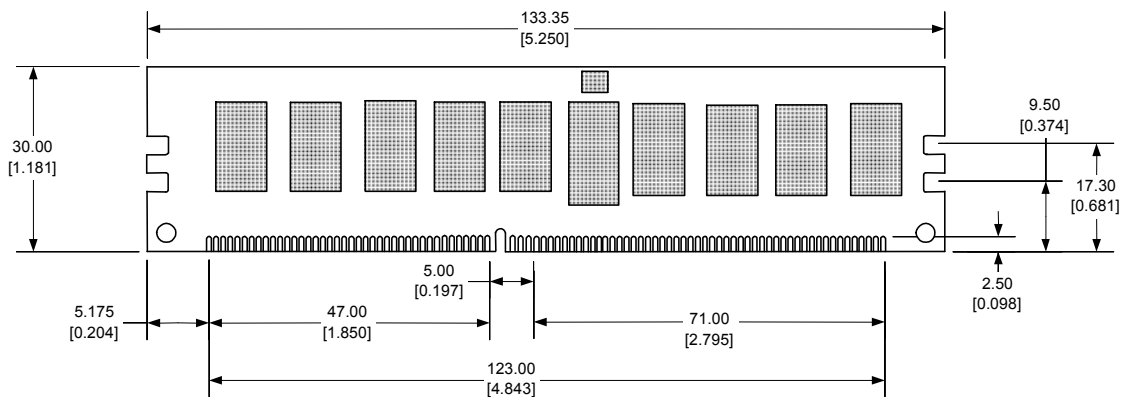

Back view

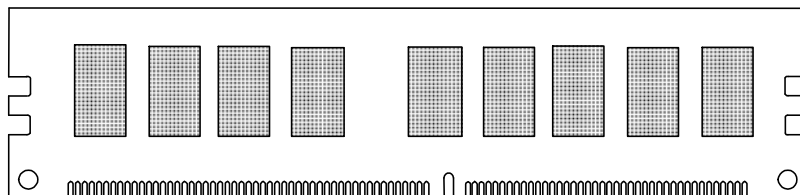

Side view

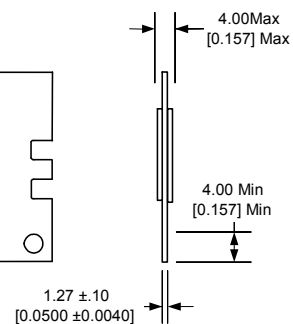

Notes

Tolerances on all dimensions except where otherwise indicated are ±.13 (.005).

All dimensions are expressed: millimeters [inches]

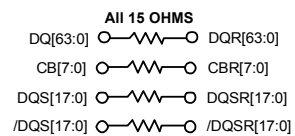
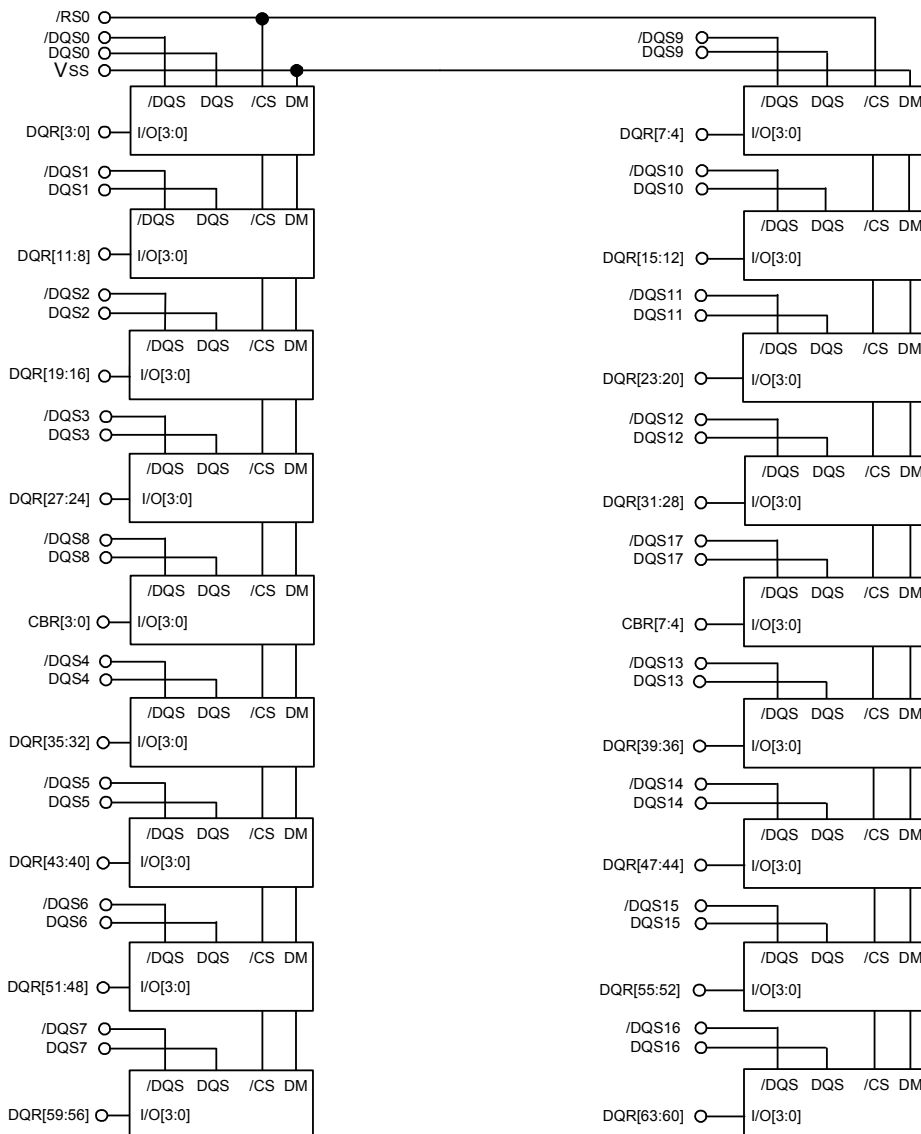

GLOBAL SDRAM CONNECTS

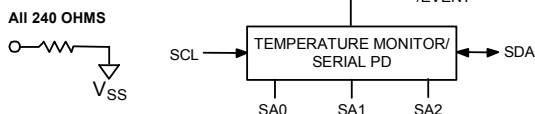
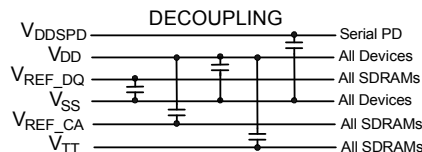
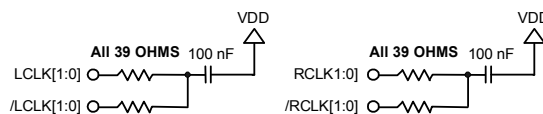
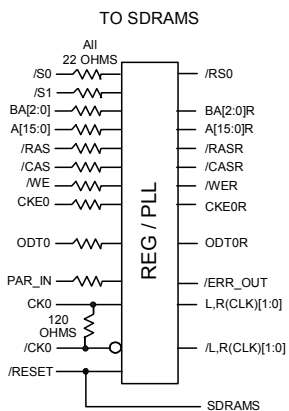
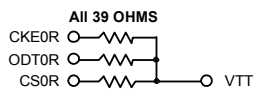
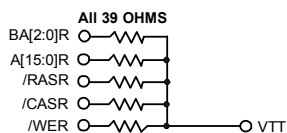



DTM64460C

8GB - 240-Pin 1Rx4 Registered ECC DDR3 DIMM

Absolute Maximum Ratings

(Note: Operation at or above Absolute Maximum Ratings can adversely affect module reliability.)

PARAMETER	Symbol	Minimum	Maximum	Unit
Temperature, non-Operating	T _{STORAGE}	-55	100	C
Ambient Temperature, Operating	T _A	0	70	C
DRAM Case Temperature, Operating	T _{CASE}	0	95	C
Voltage on V _{DD} relative to V _{SS}	V _{DD}	-0.4	1.975	V
Voltage on Any Pin relative to V _{SS}	V _{IN} , V _{OUT}	-0.4	1.975	V

Notes:

DRAM Operating Case Temperature above 85C requires 2X refresh.

Recommended DC Operating Conditions (T_A = 0 to 70 C, Voltage referenced to V_{SS} = 0 V)

PARAMETER	Symbol	Minimum	Typical	Maximum	Unit	Note
Power Supply Voltage	V _{DD}	1.425	1.5	1.575	V	
I/O Reference Voltage	V _{REFDQ}	0.49 V _{DD}	0.50 V _{DD}	0.51 V _{DD}	V	1
I/O Reference Voltage	V _{REFCA}	0.49 V _{DD}	0.50 V _{DD}	0.51 V _{DD}	V	1

Notes:

1) The value of V_{REF} is expected to equal one-half V_{DD} and to track variations in the V_{DD} DC level. Peak-to-peak noise on V_{REF} may not exceed ±1% of its DC value. For Reference V_{DD}/2 ± 15 mV.

DC Input Logic Levels, Single-Ended (T_A = 0 to 70 C, Voltage referenced to V_{SS} = 0 V)

PARAMETER	Symbol	Minimum	Maximum	Unit
Logical High (Logic 1)	V _{IH(DC)}	V _{REF} + 0.1	V _{DD}	V
Logical Low (Logic 0)	V _{IL(DC)}	V _{SS}	V _{REF} - 0.1	V

AC Input Logic Levels, Single-Ended (T_A = 0 to 70 C, Voltage referenced to V_{SS} = 0 V)

PARAMETER	Symbol	Minimum	Maximum	Unit
Logical High (Logic 1)	V _{IH(AC)}	V _{REF} + 0.175	-	V
Logical Low (Logic 0)	V _{IL(AC)}	-	V _{REF} - 0.175	V

Differential Input Logic Levels ($T_A = 0$ to 70 C, Voltage referenced to $V_{SS} = 0$ V)

PARAMETER	Symbol	Minimum	Maximum	Unit
Differential Input Logic High	$V_{IH,DIFF}$	+0.200	DC: V_{DD} AC: $V_{DD}+0.4$	V
Differential Input Logic Low	$V_{IL,DIFF}$	DC: V_{SS} AC: $V_{SS}-0.4$	-0.200	V
Differential Input Cross Point Voltage relative to $V_{DD}/2$	V_{IX}	- 0.150	+ 0.150	V

Capacitance ($T_A = 25$ C, $f = 100$ MHz)

PARAMETER	Pin	Symbol	Minimum	Maximum	Unit
Input Capacitance, Clock	CK0, /CK0	C_{CK}	1.5	2.5	pF
Input Capacitance, Address	BA[2:0], A[15:0], /RAS, /CAS, /WE	C_i	1.5	2.5	pF
Input Capacitance Control	/S[1:0], CKE[1:0], ODT[1:0]	C_i	1.5	2.5	pF
Input/Output Capacitance	DQ[63:0], CB[7:0] DQS[17:0], /DQS[17:0]	C_{IO}	1.5	2.5	pF
ZQ Capacitance	ZQ	C_{ZQ}	-	6	pF

DC Characteristics ($T_A = 0$ to 70 C, Voltage referenced to $V_{SS} = 0$ V)

PARAMETER	Symbol	Minimum	Maximum	Unit	Note
Input Leakage Current (Any input 0 V < V_{IN} < V_{DD})	I_{IL}	-18	+18	μ A	1,2
Output Leakage Current (0 V < V_{OUT} < V_{DDQ})	I_{OL}	-10	+10	μ A	2,3

Notes:

- 1) All other pins not under test = 0 V
- 2) Values are shown per pin
- 3) DQ, DQS, DQS and ODT are disabled



DTM64460C

8GB - 240-Pin 1Rx4 Registered ECC DDR3 DIMM

I_{DD} Specifications and Conditions (T_A = 0 to 70 °C, Voltage referenced to V_{SS} = 0 V)

PARAMETER	Symbol	Test Condition	Max Value	Unit
Operating One Bank Active-Precharge Current	I _{DD0}	Operating current : One bank ACTIVATE-to-PRECHARGE	1210	mA
Operating One Bank Active-Read-Precharge Current	I _{DD1}	Operating current : One bank ACTIVATE-to-READ-to-PRECHARGE	1460	mA
Precharge Power-Down Current	I _{DD2P}	Precharge power down current: (Slow exit)	700	mA
Precharge Power-Down Current	I _{DD2P}	Precharge power down current: (Fast exit)	700	mA
Precharge Quiet Standby Current	I _{DD2Q}	Precharge quiet standby current	1070	mA
Precharge Standby Current	I _{DD2N}	Precharge standby current	870	mA
Active Power-Down Current	I _{DD3P}	Active power-down current	990	mA
Active Standby Current	I _{DD3N}	Active standby current	1040	mA
Operating Burst Write Current	I _{DD4W}	Burst write operating current	2070	mA
Operating Burst Read Current	I _{DD4R}	Burst read operating current	2050	mA
Burst Refresh Current	I _{DD5}	Refresh current	4200	mA
Self Refresh Current	I _{DD6}	Self-refresh temperature current: MAX T _c = 85°C	570	mA
Operating Bank Interleave Read Current	I _{DD7}	All bank interleaved read current	3060	mA

AC Operating Conditions

PARAMETER	Symbol	Min	Max	Unit
Internal read command to first data	t_{AA}	13.125	20	ns
CAS-to-CAS Command Delay	t_{CCD}	4	-	t_{CK}
Clock High Level Width	$t_{CH(avg)}$	0.47	0.53	t_{CK}
Clock Cycle Time	t_{CK}	1.071	3.3	ns
Clock Low Level Width	$t_{CL(avg)}$	0.47	0.53	t_{CK}
Data Input Hold Time after DQS Strobe	t_{DH}	20	-	ps
DQ Input Pulse Width	t_{DIPW}	320	-	ps
DQS Output Access Time from Clock	t_{DQSK}	-195	+195	ps
Write DQS High Level Width	t_{DQSH}	0.45	0.55	$t_{CK(avg)}$
Write DQS Low Level Width	t_{DQSL}	0.45	0.55	$t_{CK(avg)}$
DQS-Out Edge to Data-Out Edge Skew	t_{DQSQ}	-	85	ps
Data Input Setup Time Before DQS Strobe	t_{DS}	-	-	ps
DQS Falling Edge from Clock, Hold Time	t_{DSH}	0.18	-	$t_{CK(avg)}$
DQS Falling Edge to Clock, Setup Time	t_{DSS}	0.18	-	$t_{CK(avg)}$
Clock Half Period	t_{HP}	minimum of t_{CH} or t_{CL}	-	ns
Address and Command Hold Time after Clock	t_{IH}	120	-	ps
Address and Command Setup Time before Clock	t_{IS}	45	-	ps
Load Mode Command Cycle Time	t_{MRD}	4	-	t_{CK}
DQ-to-DQS Hold	t_{QH}	0.38	-	$t_{CK(avg)}$
Active-to-Precharge Time	t_{RAS}	34	$9 \cdot t_{REFI}$	ns
Active-to-Active / Auto Refresh Time	t_{RC}	47.125	-	ns
RAS-to-CAS Delay	t_{RCD}	13.125	-	ns
Average Periodic Refresh Interval $0^{\circ}C \leq T_{CASE} < 85^{\circ}C$	t_{REFI}	-	7.8	μs
Average Periodic Refresh Interval $0^{\circ}C \leq T_{CASE} < 95^{\circ}C$	t_{REFI}	-	3.9	μs
Auto Refresh Row Cycle Time	t_{RFC}	260	-	ns
Row Precharge Time	t_{RP}	13.125	-	ns
Read DQS Preamble Time	t_{RPRE}	0.9	Note-1	$t_{CK(avg)}$
Read DQS Postamble Time	t_{RPST}	0.3	Note-2	$t_{CK(avg)}$
Row Active to Row Active Delay	t_{RRD}	Max(4nCK, 5ns)	-	ns
Internal Read to Precharge Command Delay	t_{RTP}	Max(4nCK, 7.5ns)	-	ns
Write DQS Preamble Setup Time	t_{WPRES}	0.9	-	$t_{CK(avg)}$
Write DQS Postamble Time	t_{WPST}	0.3	-	$t_{CK(avg)}$
Write Recovery Time	t_{WR}	15	-	ns
Internal Write to Read Command Delay	t_{WTR}	Max(4nCK, 7.5ns)	-	ns

Notes:

1. The maximum preamble is bound by $t_{LZDQS}(\min)$
2. The maximum postamble is bound by $t_{HZDQS}(\max)$



DTM64460C

8GB - 240-Pin 1Rx4 Registered ECC DDR3 DIMM



DATARAM CORPORATION, USA Corporate Headquarters, P.O. Box 7528, Princeton, NJ 08543-7528;
Voice: 609-799-0071, Fax: 609-799-6734; www.dataram.com

All rights reserved.

The information contained in this document has been carefully checked and is believed to be reliable. However, Dataram assumes no responsibility for inaccuracies.

The information contained in this document does not convey any license under the copyrights, patent rights or trademarks claimed and owned by Dataram.

No part of this publication may be copied or reproduced in any form or by any means, or transferred to any third party without prior written consent of Dataram.