

RELAY SOCKETS]

Snap-In Socket Assemblies

CUS Series

RS Series

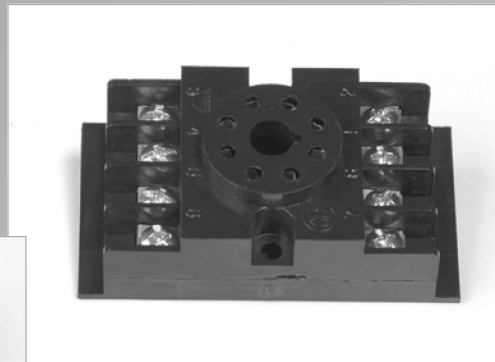
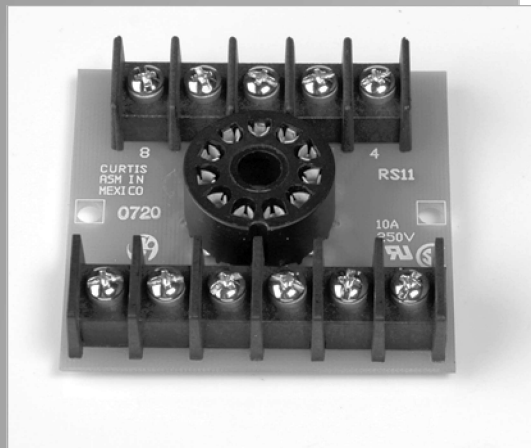

*Snap-In Socket Assemblies

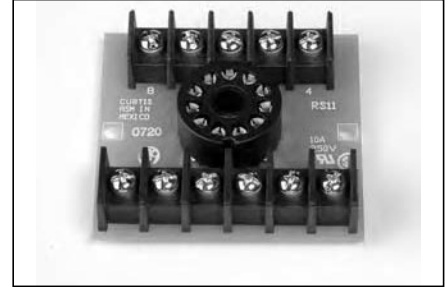
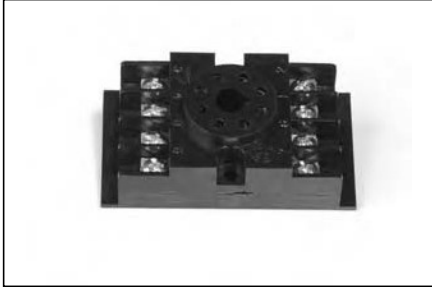

Features:

- Permanent-numbered terminals for easy identification
- New unitized, thermoplastic sockets with closed-back design which eliminates panel insulation, and resists breakage
- Nickel-plated screw-type terminals on break-resistant barrier-type terminal block for fast, easy connection. Screw-type terminals on other models with captivated wire clamps to eliminate lugging.
- Compact, printed circuit design
- Glass epoxy G-10 printed circuit boards
- Relay sockets can be spaced out in track for convenient insertion of marking strips, for relay identification
- High-quality sockets for maximum relay retention and electrical conductivity

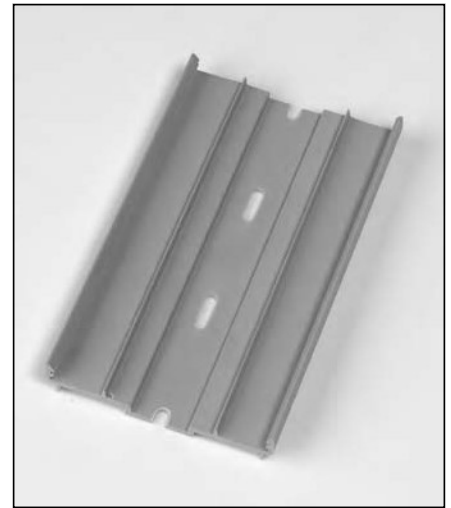
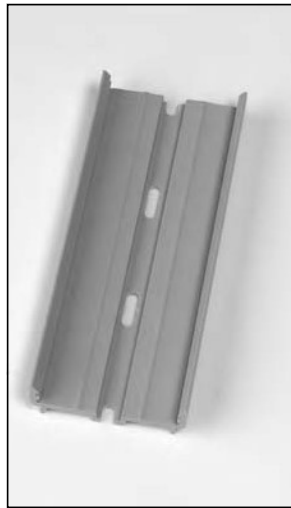

Track



- Assemblies snap in and out without disturbing adjacent units (except for dovetail design on CUS5, 12, 14, 15, and 16)
- Lengths up to 48" – holds up to 30 socket assemblies
- Pre-punched track minimizes mounting time. (On lengths of 48", drilling and tapping is only required for two or three mounting screws instead of two holes per socket.)
- Wide center channel provides space for under-board components. Allows greater surface area for easy mounting with adhesive tape.
- Grey PVC thermoplastic, UL flame class 94V-0, suitable for ambient temperatures up to 50° C.
- Vertical rib track provides support to prevent PC board breakage—supplies spring retention and electrical base insulation.
- Optional snap-on end retaining clips available for long vertical mounts or extreme vibration if end socket assembly is not mounted with screws.
- Available in three popular widths for maximum circuit design flexibility.
 - TR1 for 2-3/16" board or socket
 - TR2 for 2-3/4" PC board or socket.
 - TR3 for 3-1/4" PC board or socket

HOW TO ORDER

Relay socket assemblies can be ordered in parts form (assemblies and track separate) or factory assembled in specific length units. When ordering factory assembled units, specify type — number of sockets in continuous one-piece precut track; for example, order RS8-17 for a track containing 17 RS8 relay socket assemblies.

* Many Curtis Socket Assemblies are recognized under the Components Program of Underwriters Laboratories, Inc. under file No. E59934. These units are made with a  on the following pages. Socket Assemblies listed by Canadian Standards Association are marked with a  and are covered by Report No. LR19623.



CUS Series

CUS8 and CUS11

8 and 11-Pin Unitized Octal-Type Socket Assemblies

Specifications:

Rating: 10 amps, 300 volts

Track: TR2

48" length holds up to 30 CUS8 sockets and 21 CUS11 sockets

Terminals: 6 thru 32 with captivated traveling nut

Wire: Up to No. 12AWG wire

Sockets: CUS8 – 8-pin receptacle for 2PDT octal relay or timer
CUS11 – 11-pin receptacle for 3PDT octal relay or timer

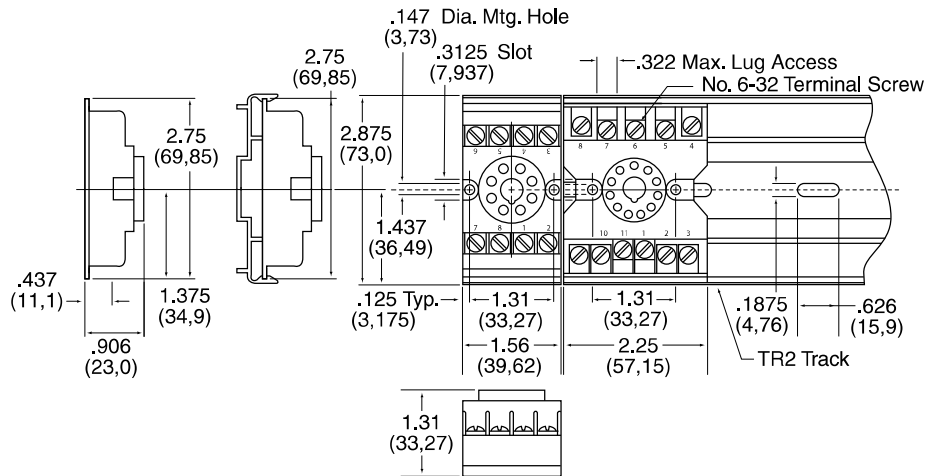
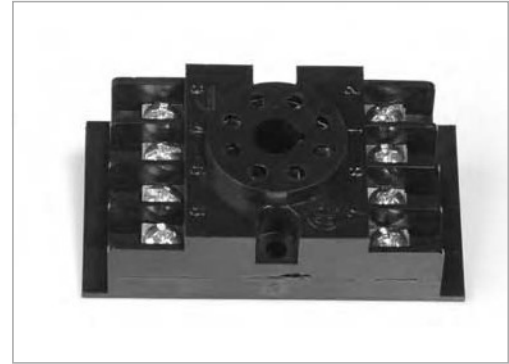

CUS5, CUS12 and CUS16

5, 8 and 11-Pin Unitized Square-Base Relay-Type Socket Assemblies

Specifications:

Rating: 15 amps, 250 volts (CSA rated 15 amps, 125 volts)

Track: TR3

48" length holds up to 28 sockets

Terminals: 6 thru 32 with captivated traveling nut

Wire: Up to No. 14AWG wire

Sockets: CUS12 – 11-pin receptacle for 3PDT square-base barrier-type plug-in relays
CUS16 – 8-pin receptacle for 2PDT square-base, barrier type plug-in relays
CUS5 – 5-pin receptacle for SPDT square-base, barrier type plug-in relays

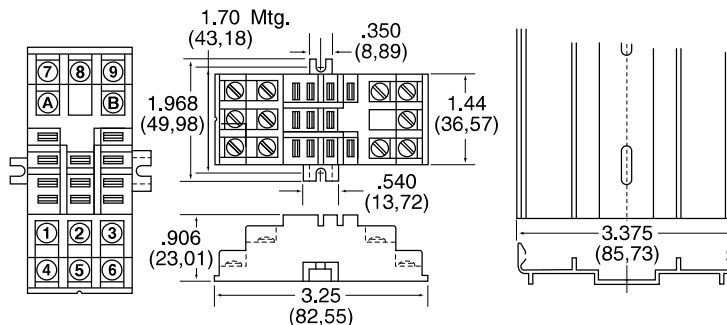
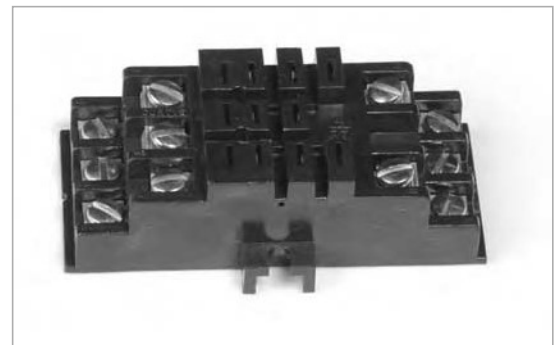

RELAY SOCKETS



RS Series

RS8

8-Pin Octal-Type Socket Assemblies

Specifications:

Rating: 10 amps, 250 volts

Track: TR2

48" length holds up to 24 sockets

No. of Terminals: RS8 – No. 6-32 screws, 7/16" center-to-center spacing



Wire: RS8 – up to No. 12 AWG (lugs are recommended on wire larger than No. 16AWG)

Sockets: 8-pin octal receptacle to accept standard 2PDT chamber allows relays to be rocked out without danger of damaging relay center posts. PC board has center post clearance hole to allow relays with screws in center post. Phosphor bronze contacts for better pin contact and retention.

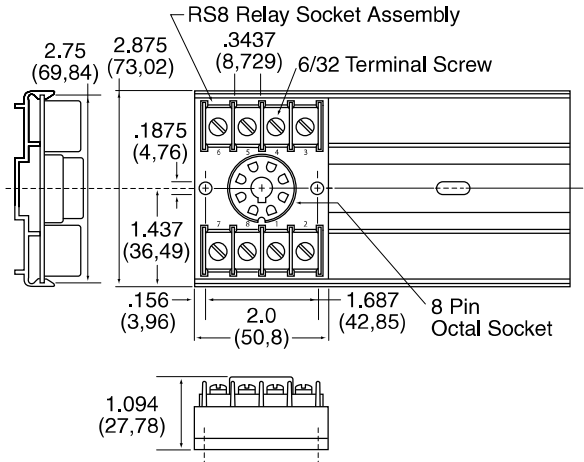

RS11

11-Pin Octal-Type Socket Assemblies

Specifications:

Rating: 10 amps, 250 volts

Track: TR2

48" length holds up to 16 sockets

No. of Terminals: RS11 – No. 6-32 screws, 7/16" center-to-center spacing

Wire: RS11 – up to No. 12 AWG (lugs are recommended on wire larger than No. 16AWG)

Sockets: 11-pin octal receptacle to accept 3PDT chamber allows relays. Refer to RS8 socket for features.

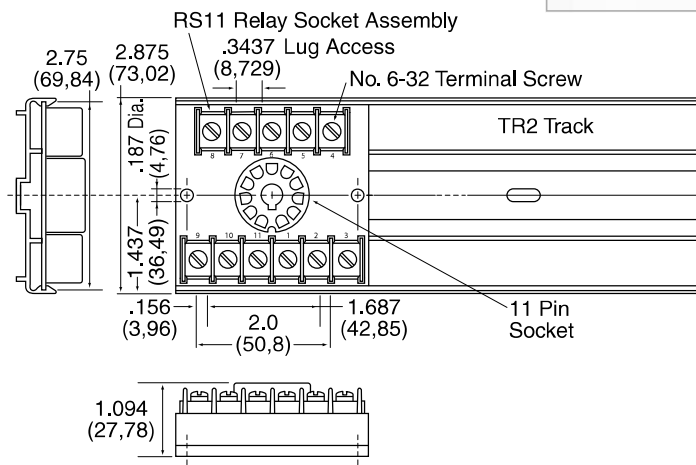

RS2, RS4 and RS6

10, 16, and 22-Pin Square-Base
Miniature Relay-Type Socket Assemblies

Specifications:

Rating: 5 amps, 125 volts (UL rated 3 amps, 125 volts)

Track: TR1

48" length holds up to 24 RS2 sockets, 21 RS4 sockets and 16 RS6 sockets

No. of Terminals: No. 2-56 screws with clamp – 1/4" center-to-center spacing

Wire: Up to No. 16AWG

Sockets: RS2 – 10-pin receptacle to accept miniature 2PDT relays with latching coils

RS4 – 16-pin receptacle to accept miniature 4PDT relays with latching coils

RS6 – 22-pin receptacle to accept miniature 6PDT relays with latching coils

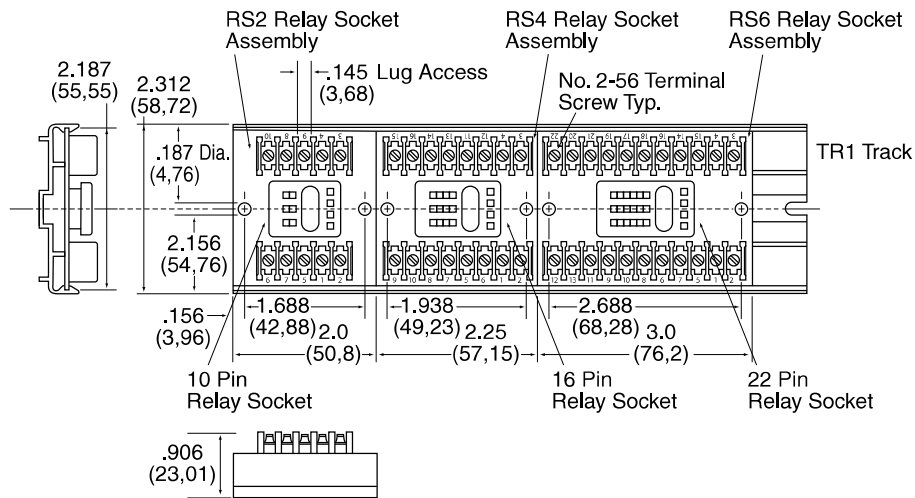
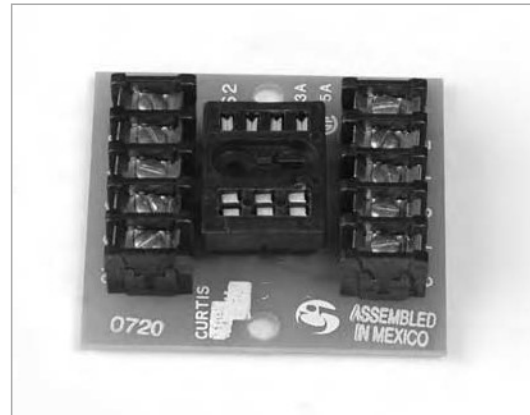
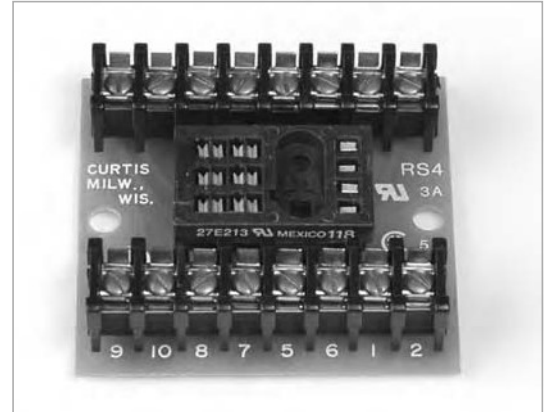

RS12 and RS16

12 and 16-Pin Square-Base Relay-Type
Socket Assemblies

Specifications:

Rating: 10 amps, 250 volts

Track: TR3

48" length holds up to 16 RS12 sockets

48" length holds up to 22 RS16 sockets

No. of Terminals: RS12 and RS16 – No. 6-32 screws, 7/16" center-to-center spacing

Wire: RS12 and RS16 – up to No. 12 AWG (lugs are recommended on wire larger than No. 16AWG)

Sockets: RS12 – 11 pin receptacle to accept 3PDT relays

RS16 – 8-pin receptacle to accept 2PDT relays

Note: RS12 – CSA rating is 10 amps, 125 volts

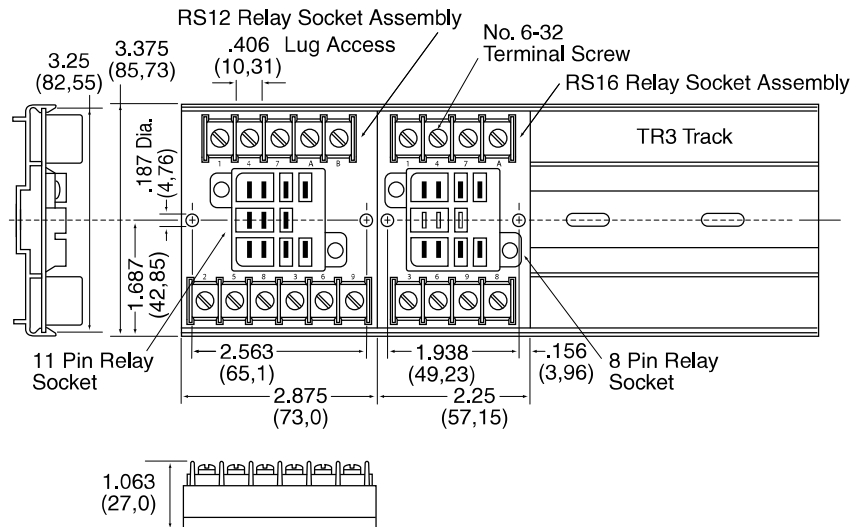
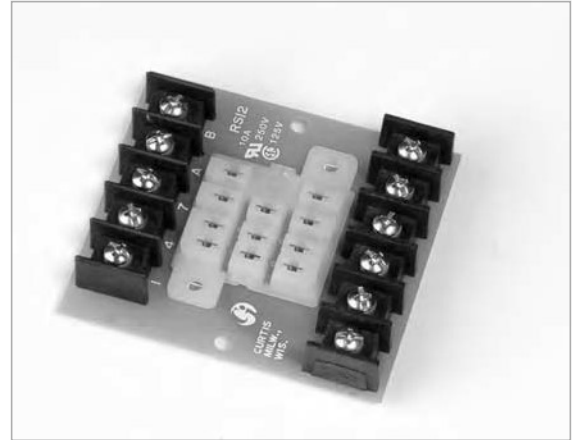

RS14

14-Pin Square-Base Miniature Relay-Type Socket Assemblies

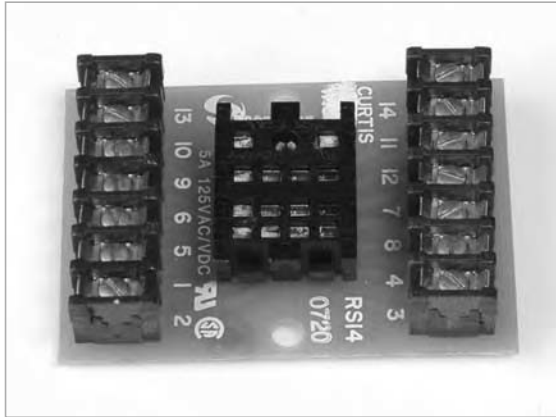

Specifications:

Rating: 5 amps, 125 volts

Track: TR2

48" length holds up to 16 sockets

No. of Terminals: No. 2-56 screws with clamps (1/4" center-to-center spacing)

Wire: up to two No. 16AWG

Sockets: 14-pin receptacle to accept miniature 4PDT relays

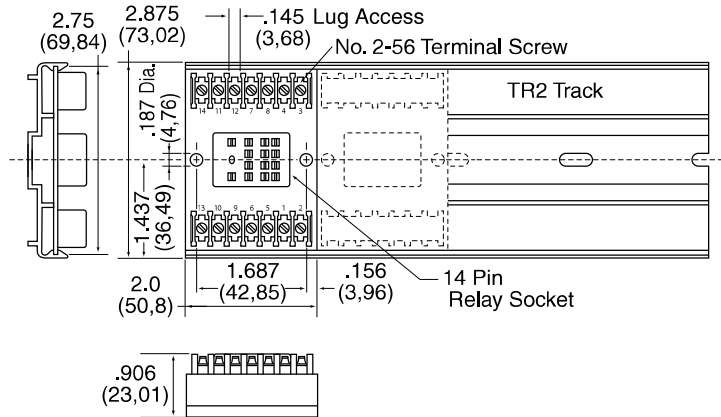

RS15

15-Pin Square-Base Grounded Miniature Relay-Type Socket Assemblies

Specifications:

Rating: 5 amps, 125 volts

Track: TR1

48" length holds up to 21 sockets

No. of Terminals: No. 2-56 screws with clamp (1/4" center-to-center spacing)

Wire: Up to No. 16AWG

Sockets: 15-pin receptacle to accept grounded miniature 4PDT relays

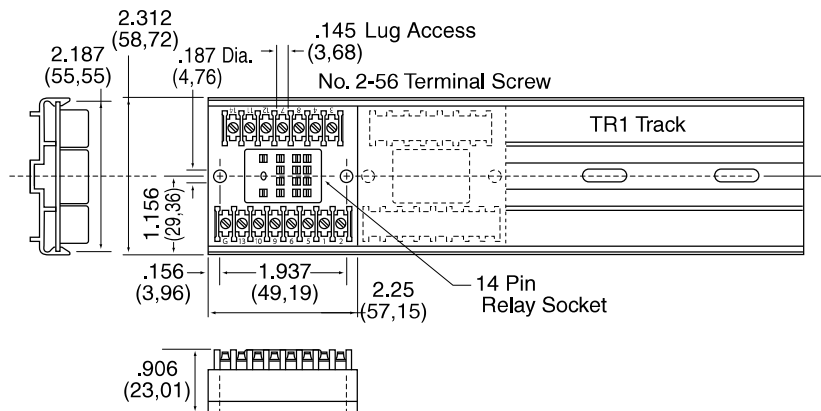
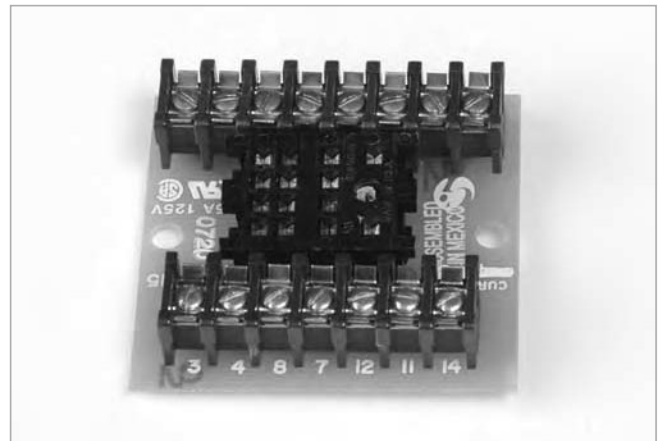

RS & CUS Series

ACCESSORIES



- 18836 – (RS2 socket only)
- 18837 – (RS4 socket only)
- 18838 – (RS6 socket only)
- 18830 – (RS14 & 15 socket only)
- 18831 – (RS12 socket only)
- 18835 – Round 11-pin socket (RS11)
- 18821 – Round octal socket (RS8)
- 18832 – Square 8-pin socket (RS16)
- 44613 – Tie down bail (CUS5, 12, 16)
- 44617 – Relay hold down clip (CUS5, 12, 16)
- 62610 – TR track end clips



RELAY SOCKETS

