

**SERIES:** VOF-S25B | **DESCRIPTION:** AC-DC POWER SUPPLY

**FEATURES**

- universal input range (90 ~ 264 Vac)
- option to support large transient loads (2x rated current)<sup>4</sup>
- Class B emissions (EN55032/CISPR/FCC)
- certified to IEC/EN/UL 62368-1
- designed to meet IEC/EN 60335
- short circuit protection
- over voltage protection
- < 100 mW no-load power consumption
- Class II



| MODEL       | output voltage<br>(Vdc) | output current |            | output power<br>max<br>(W) | ripple and noise <sup>1</sup><br>max<br>(mVp-p) | efficiency <sup>2</sup><br>typ<br>(%) |
|-------------|-------------------------|----------------|------------|----------------------------|---|---------------------------------------|
|             |                         | min<br>(A)     | max<br>(A) |                            |   |                                       |
| VOF-S25B-5  | 5                       | 0              | 4.00       | 20                         | 50  | 81                                    |
| VOF-S25B-12 | 12                      | 0              | 2.10       | 25                         | 120   | 84                                    |
| VOF-S25B-15 | 15                      | 0              | 1.67       | 25                         | 150   | 85                                    |
| VOF-S25B-24 | 24                      | 0              | 1.05       | 25                         | 240   | 86                                    |
| VOF-S25B-36 | 36                      | 0              | 0.70       | 25                         | 360   | 87                                    |
| VOF-S25B-48 | 48                      | 0              | 0.52       | 25                         | 480   | 87                                    |

- Notes:
1. At full load, nominal input, 20 MHz bandwidth oscilloscope, with 1  $\mu$ F ceramic and 10  $\mu$ F electrolytic capacitors on the output.
  2. At 230 Vac, full load, 25°C.
  3. All specifications are measured at  $T_a=25^\circ\text{C}$ , nominal input voltage, and 75% rated output load unless otherwise specified.
  4. Parts with the "-PB" suffix can sustain 2 times the rated output load for 10 seconds (MAX) and 10% duty cycle (MAX). This functionality requires a 33  $\mu$ F / 400 V capacitor connected between pins BC+ and BC-. See Power Boost Section below for more details.

**PART NUMBER KEY**

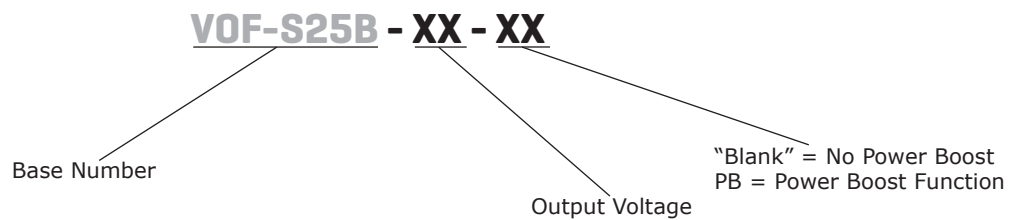

## INPUT

| parameter       | conditions/description       | min | typ | max  | units |
|-----------------|------------------------------|-----|-----|------|-------|
| voltage         |                              | 90  |     | 264  | Vac   |
|                 |                              | 120 |     | 370  | Vdc   |
| frequency       |                              | 47  |     | 63   | Hz    |
| current         | at 100 Vac, full load        |     |     | 700  | mA    |
| inrush current  | at 240 Vac, cold start, 25°C |     |     | 60   | A     |
| leakage current | at 264 Vac                   |     |     | 0.25 | mA    |

## OUTPUT

| parameter                  | conditions/description                         | min | typ   | max    | units |
|----------------------------|--|-----|-------|--------|-------|
| capacitive load            | 5 Vdc output models                            |     |       | 81,000 | μF    |
|                            | 12 Vdc output models                           |     |       | 40,900 | μF    |
|                            | 15 Vdc output models                           |     |       | 19,800 | μF    |
|                            | 24 Vdc output models                           |     |       | 6,600  | μF    |
|                            | 36 Vdc output models                           |     |       | 4,000  | μF    |
|                            | 48 Vdc output models                           |     |       | 2,170  | μF    |
| initial set point accuracy | 5 Vdc output model                             |     |       | ±2     | %     |
|                            | all other models                               |     |       | ±1     | %     |
| line regulation            | measured at high line to low line at full load |     |       | ±1     | %     |
| load regulation            | measured at 10%~100% load                      |     |       | ±1     | %     |
| start-up time              |  |     |       | 3      | s     |
| hold-up time               | at 115 Vac                                     |     | 8     |        | ms    |
| switching frequency        |  |     | 65    |        | kHz   |
| temperature coefficient    |  |     | ±0.05 |        | %/°C  |

## PROTECTIONS

| parameter                | conditions/description      | min | typ  | max | units |
|--------------------------|-----------------------------|-----|------|-----|-------|
| over voltage protection  | TVS to clamp output voltage |     |      |     |       |
|                          | 5 Vdc output models         |     | 6.8  |     | Vdc   |
|                          | 12 Vdc output models        |     | 15.0 |     | Vdc   |
|                          | 15 Vdc output models        |     | 18.0 |     | Vdc   |
|                          | 24 Vdc output models        |     | 30.0 |     | Vdc   |
|                          | 36 Vdc output models        |     | 47.0 |     | Vdc   |
|                          | 48 Vdc output models        |     | 56.0 |     | Vdc   |
| short circuit protection | hiccup, auto recovery       |     |      |     |       |

## SAFETY & COMPLIANCE

| parameter                      | conditions/description  | min   | typ | max | units |
|--------------------------------|---|-------|-----|-----|-------|
| isolation voltage              | input to output for 1 minute  | 3,000 |     |     | Vac   |
| isolation resistance           |   | 100   |     |     | MΩ    |
| safety approvals               | certified to IEC/EN/UL 62368-1<br>designed to meet IEC/EN 60335               |       |     |     |       |
| safety class                   | Class II  |       |     |     |       |
| conducted emissions            | EN55032, EN61000-6-3:2012, Class B,<br>47 CFR FCC Part 15 Subpart B (Class B) |       |     |     |       |
| radiated emissions             | EN55032, EN61000-6-3:2012, Class B,<br>47 CFR FCC Part 15 Subpart B (Class B) |       |     |     |       |
| harmonic current emissions     | EN61000-3-2:2014  |       |     |     |       |
| voltage fluctuations & flicker | EN61000-3-3:2013  |       |     |     |       |

**SAFETY & COMPLIANCE (CONTINUED)**

| parameter                      | conditions/description  | min     | typ | max | units |
|--------------------------------|---|---------|-----|-----|-------|
| ESD                            | IEC61000-4-2:2008, air discharge: $\pm 8$ kV, contact discharge: $\pm 4$ kV |         |     |     |       |
| radiated immunity              | IEC61000-4-3:2010   |         |     |     |       |
| EFT/burst                      | IEC61000-4-4:2012, $\pm 0.5$ kV, $\pm 1$ kV, $\pm 2$ kV                     |         |     |     |       |
| surge                          | IEC61000-4-5:2014, L-N: $\pm 0.5$ kV, $\pm 1$ kV                            |         |     |     |       |
| conducted immunity             | IEC61000-4-6:2013   |         |     |     |       |
| power frequency magnetic field | IEC61000-4-8:2009   |         |     |     |       |
| voltage dips & interruptions   | IEC61000-4-11:2004, Dip: 30%, 10 ms, Dip: 60%, 100 ms, Dip: >95%, 5,000 ms  |         |     |     |       |
| MTBF                           | as per MIL-HDBK-217F, at 115 Vac, 25°C, GB                                  | 500,000 |     |     | hours |
| RoHS                           | yes   |         |     |     |       |

Notes: 4. The power supply is considered a component which will be installed into final equipment. The final equipment still must be tested to meet the necessary EMC directives.

**ENVIRONMENTAL**

| parameter             | conditions/description  | min | typ | max   | units |
|-----------------------|---|-----|-----|-------|-------|
| operating temperature | see derating curves   | -30 |     | 70    | °C    |
| storage temperature   |   | -30 |     | 85    | °C    |
| operating humidity    | non-condensing  |     |     | 93    | %     |
| altitude              |   |     |     | 5,000 | m     |
| vibration             | as per MIL-STD-810F Table 514.5C-VIII; 15~2000 Hz for 1 hour on each axis for 3 hours |     | 4   |       | G     |
| shock                 | as per MIL-STD-810F Table 516.5, Table 516.5-1; for 10 ms on each axis 3 times        |     | 75  |       | G     |

## DERATING CURVES

Load vs. Ambient Temperature  
(natural convection)  
5 Vdc output models

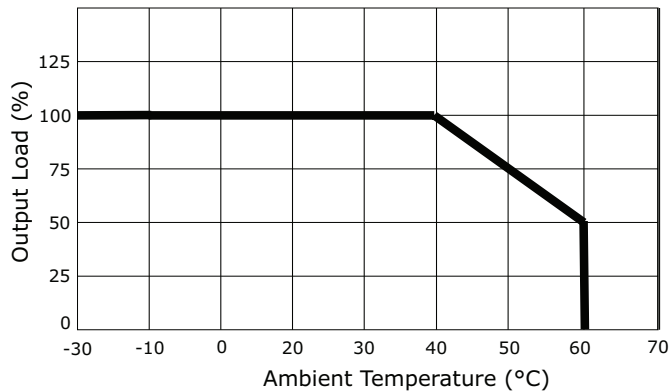

Load vs. Ambient Temperature  
(natural convection)  
All other models

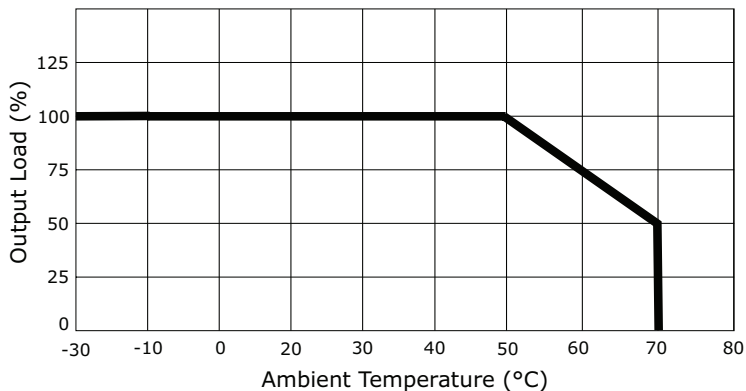

## MECHANICAL

| parameter  | conditions/description                         | min | typ | max | units  |
|------------|--|-----|-----|-----|--------|
| dimensions | 2.00 x 1.10 x 0.980 (50.80 x 27.94 x 24.90 mm) |     |     |     | inches |
| weight     |  |     | 50  |     | g      |

## MECHANICAL DRAWING

units: inch [mm]  
tolerance: ±0.020[±0.50]

| PIN CONNECTIONS |          |             |
|-----------------|----------|-------------|
| PIN             | Function |             |
|                 | Standard | Power Boost |
| 1               | AC (L)   | AC (L)      |
| 2               | AC (N)   | AC (N)      |
| 3               | +Vo      | +Vo         |
| 4               | -Vo      | -Vo         |
| 5               | No Pin   | BC+         |
| 6               | No Pin   | BC-         |

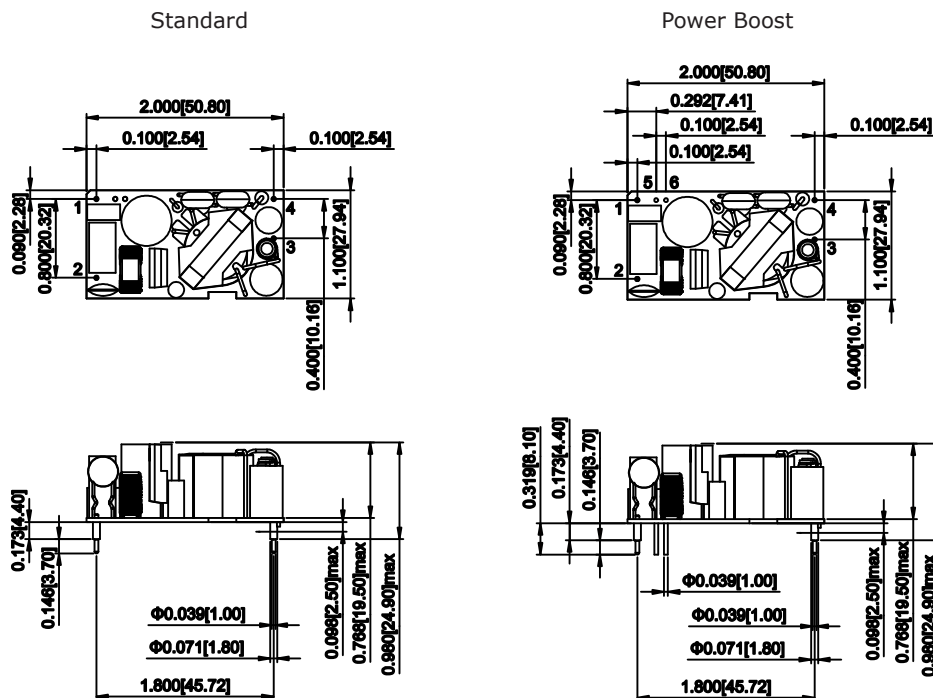

## EMC RECOMMENDATIONS

When used in a Class I system implementation (utilizing an Earth Ground connection as depicted in the schematic below), the VOF-S25B series requires additional inductance and Y-Caps to meet EN55032 Class B. These additional components are not required in a Class II implementation where no Earth Ground is present.

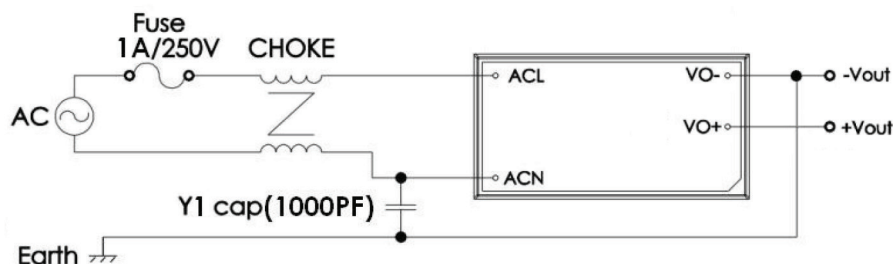

| CHOKE         |            |                      |               |
|---------------|------------|----------------------|---------------|
| Specification | Inductance | Duplex Winding/Turns | Manufacturers |
| UU9.8 R12K    | 10mH       | 2-UEW<br>Φ 0.27*85Ts | SEND POWER    |

| Y-CAP    |                   |                |               |
|----------|-------------------|----------------|---------------|
| Subclass | Withstand Voltage | Capacitance    | Manufacturers |
| Y1 CAP   | 250 V (min.)      | 1000 pF (typ.) | TDK           |

## POWER BOOST

The VOF-S25B Series has an ordering option called Power Boost ("-PB" suffix), which can double the rated output power provided to the load for a maximum of 10 seconds and repeated duty cycle of 10%. This functionality requires a 33 uF / 400 V capacitor to be connected between the BC+ and BC- pins as depicted in the schematic below. This external capacitor is not required if the VOF-S25B is operating from 220 Vac mains. When utilizing the Power Boost Feature, care must be taken not to thermally overstress the unit. The combined load (nominal plus peak) should not exceed 65% of the full load rating when averaged out over time.

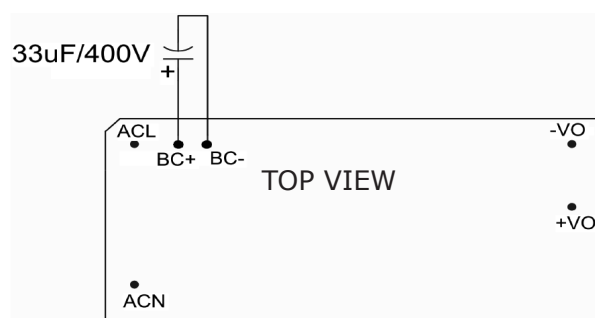

## INSTALLATION INSTRUCTIONS

The mounting holes should all be 1.5 mm in diameter. A minimum of 4 mm clearance is required for all four sides of the unit and a minimum of 5 mm clearance is required above the top surface of the unit.

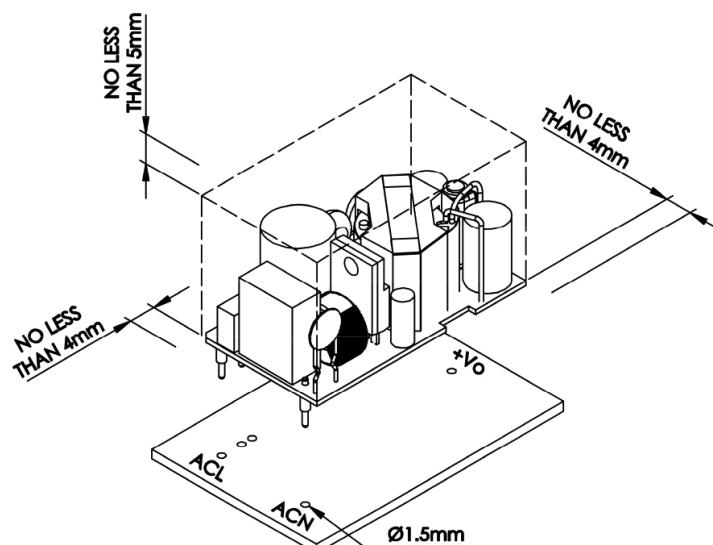

## REVISION HISTORY

---

| rev. | description                                  | date       |
|------|--|------------|
| 1.0  | initial release                              | 02/13/2020 |
| 1.01 | updates to mechanical & power boost sections | 04/08/2020 |

The revision history provided is for informational purposes only and is believed to be accurate.



**Headquarters**  
20050 SW 112th Ave.  
Tualatin, OR 97062  
**800.275.4899**

Fax 503.612.2383  
**cui.com**  
techsupport@cui.com

CUI offers a two (2) year limited warranty. Complete warranty information is listed on our website.

CUI reserves the right to make changes to the product at any time without notice. Information provided by CUI is believed to be accurate and reliable. However, no responsibility is assumed by CUI for its use, nor for any infringements of patents or other rights of third parties which may result from its use.

CUI products are not authorized or warranted for use as critical components in equipment that requires an extremely high level of reliability. A critical component is any component of a life support device or system whose failure to perform can be reasonably expected to cause the failure of the life support device or system, or to affect its safety or effectiveness.