

SERIES: CP50 | **DESCRIPTION:** PELTIER MODULE

FEATURES

- solid state device
- precise temperature control
- quiet operation



MODEL

MODEL	input voltage ¹ max (Vdc)	input current ² max (A)	output Qmax ³		output ΔTmax ⁴	
			T _n =27°C (W)	T _n =50°C (W)	T _n =27°C (°C)	T _n =50°C (°C)
CP50141	2.1	5.0	5.5	6.1	68	75
CP50241	3.8	5.0	10.0	11.1	68	75
CP50301541	4.2	5.0	11	12.3	68	75
CP50341	8.6	5.0	23.0	25.7	68	75
CP50441	15.4	5.0	41.0	45.8	68	75

- Notes:
1. Maximum voltage at ΔT max and T_n=27°C
 2. Maximum current to achieve ΔT max
 3. Maximum heat absorbed at cold side occurs at I_{max}, V_{max}, and ΔT=0°C
 4. Maximum temperature difference occurs at I_{max}, V_{max}, and Q=0W (ΔT max measured in a vacuum at 1.3 Pa)

PART NUMBER KEY

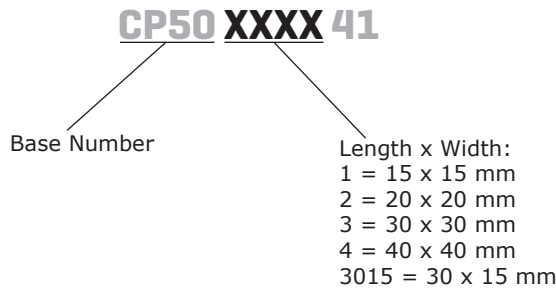

SPECIFICATIONS

parameter	conditions/description	min	typ	max	units
internal resistance ¹	CP50141	0.279	0.31	0.341	Ω
	CP50241	0.504	0.56	0.616	Ω
	CP50301541	0.567	0.63	0.693	Ω
	CP50341	1.161	1.29	1.419	Ω
	CP50441	2.07	2.3	2.53	Ω
solder melting temperature	connection between thermoelectric pairs	138			°C
assembly compression				1	MPa
hot side plate				80	°C
RoHS	2011/65/EU				

Note: 1. Measured by AC 4-terminal method at 25°C

MECHANICAL DRAWING

units: mm

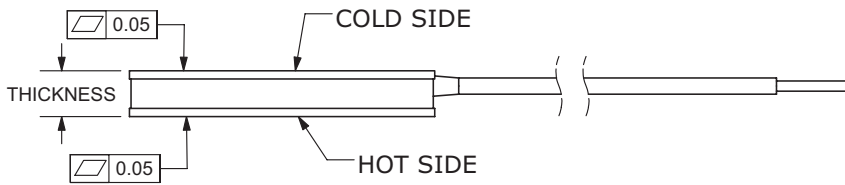

	MATERIAL	PLATING
ceramic plate	96% AL ₂ O ₃	
wire leads	20 AWG	tin
sealer	silicon rubber 703 RTV (between cold and hot side plates)	
joint cover	silicon rubber 703 RTV	
marking	P/N & S/N printed on cold side surface	

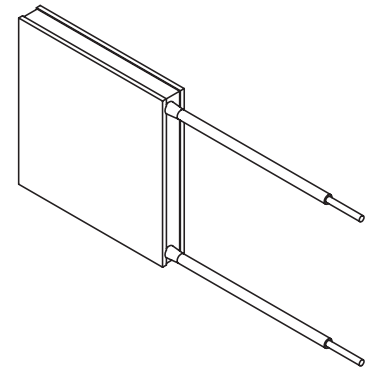
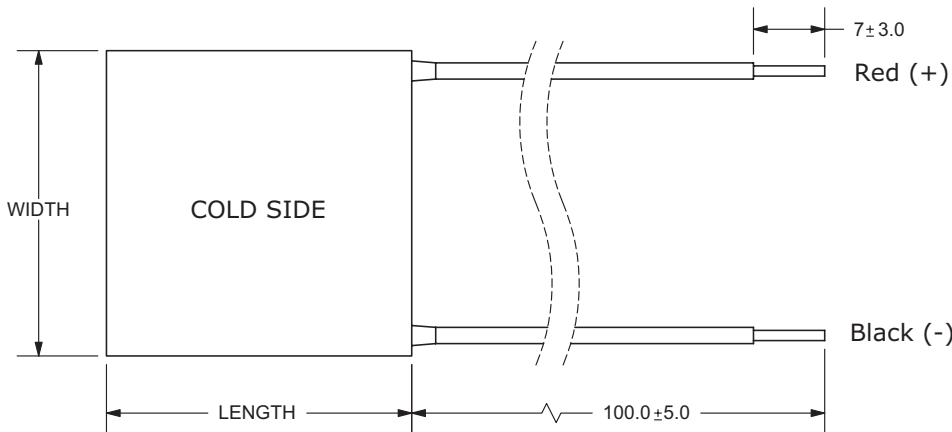

MODEL NO.	LENGTH (mm)	WIDTH (mm)	THICKNESS (mm)
CP50141	15 ±0.3	15 ±0.3	4.05 ±0.1
CP50241	20 ±0.3	20 ±0.3	4.05 ±0.1
CP50301541	30 ±0.3	15 ±0.3	4.05 ±0.1
CP50341	30 ±0.3	30 ±0.3	4.05 ±0.1
CP50441	40 ±0.3	40 ±0.3	4.05 ±0.1

CP50141 PERFORMANCE (Th=27°C)

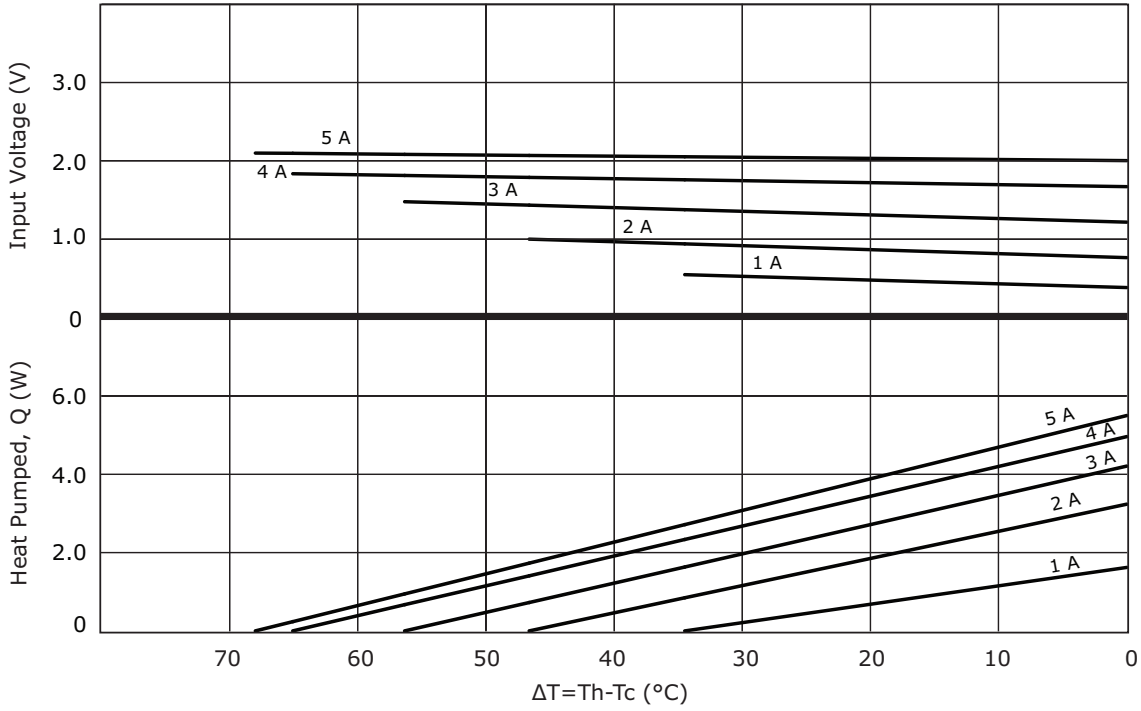

CP50141 PERFORMANCE (Th=50°C)

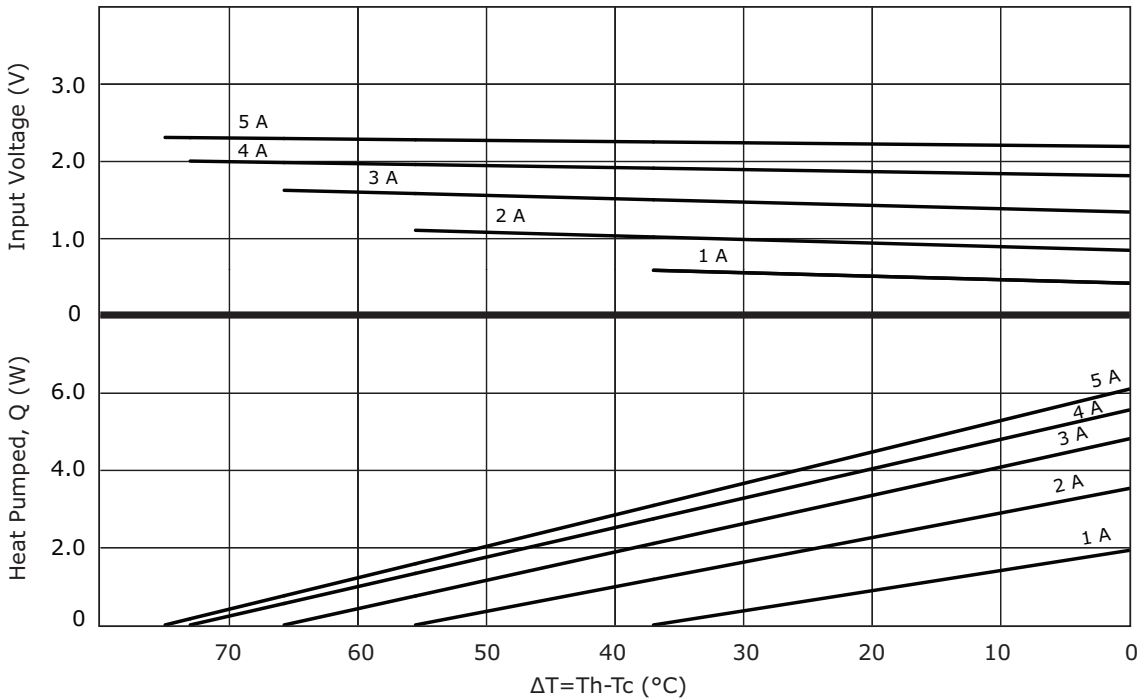

CP50241 PERFORMANCE (Th=27°C)

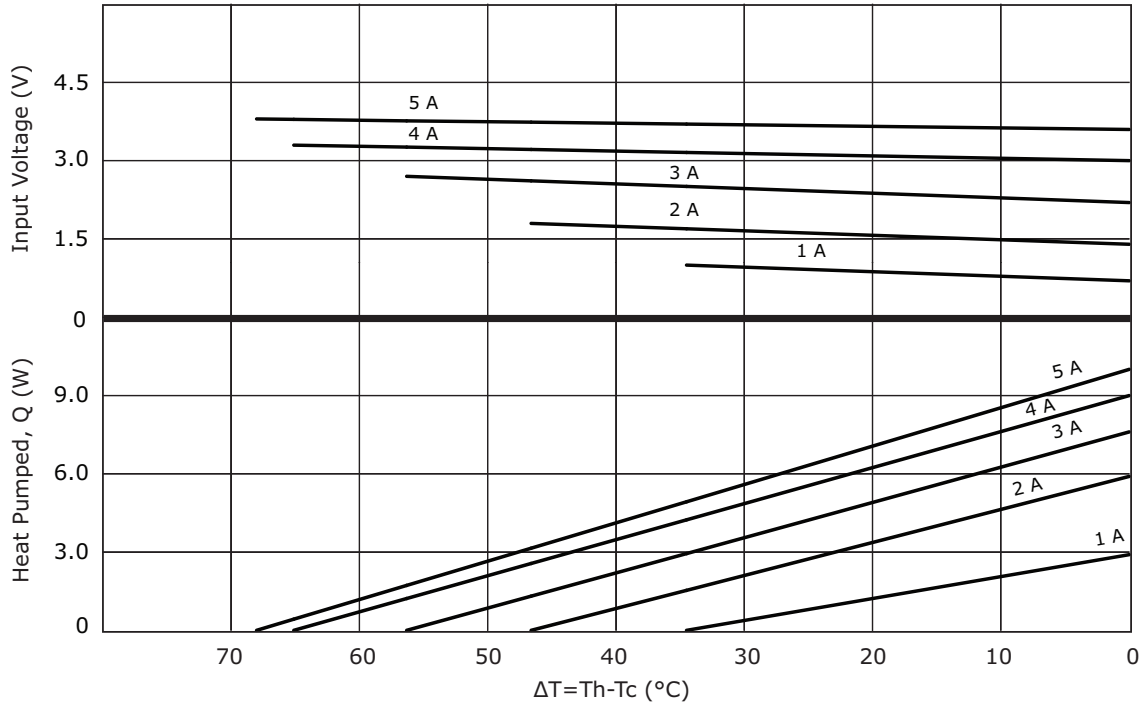

CP50241 PERFORMANCE (Th=50°C)

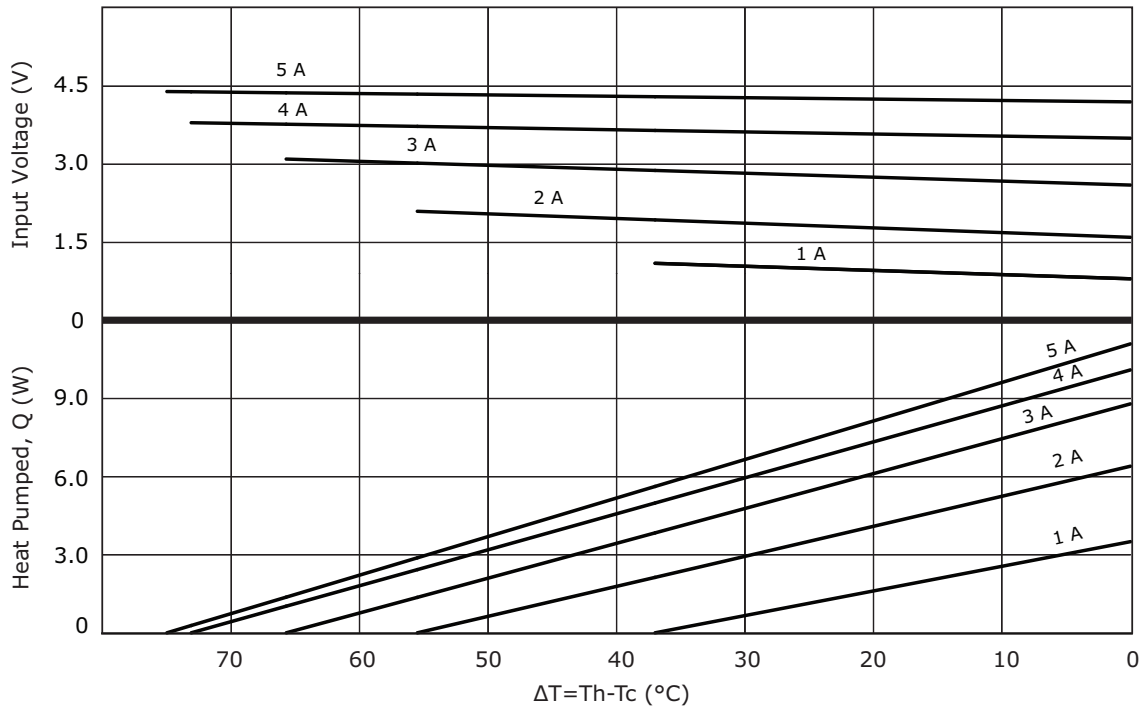

CP50301541 PERFORMANCE (Th=27°C)

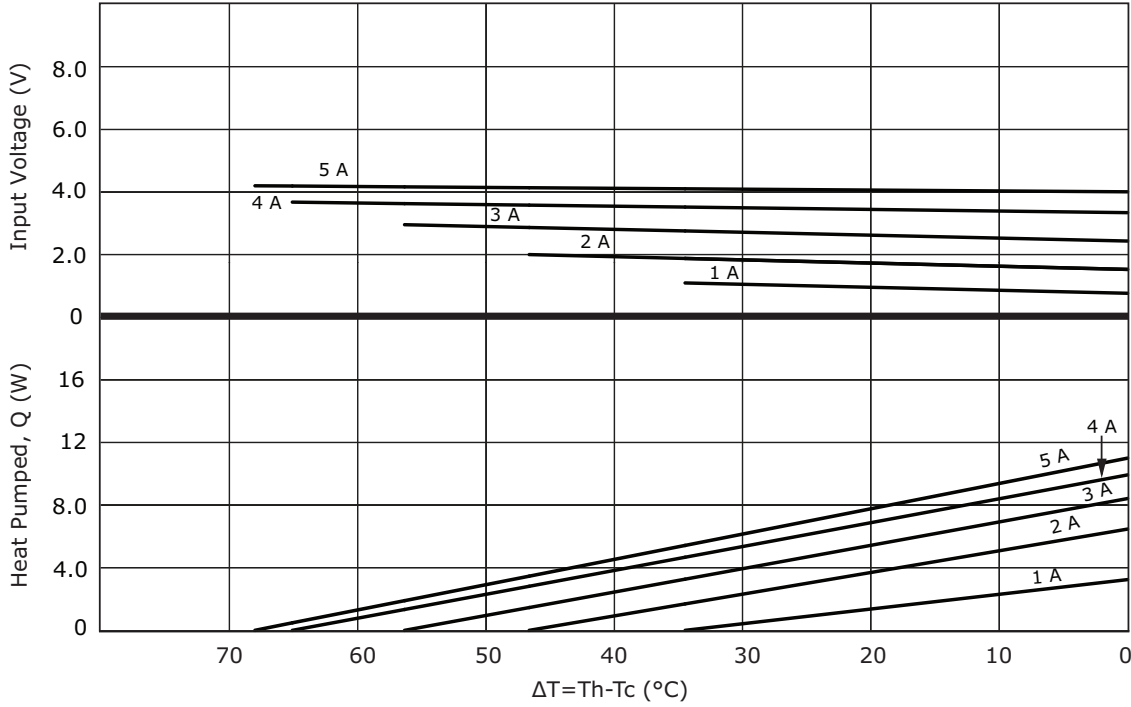

CP50301541 PERFORMANCE (Th=50°C)

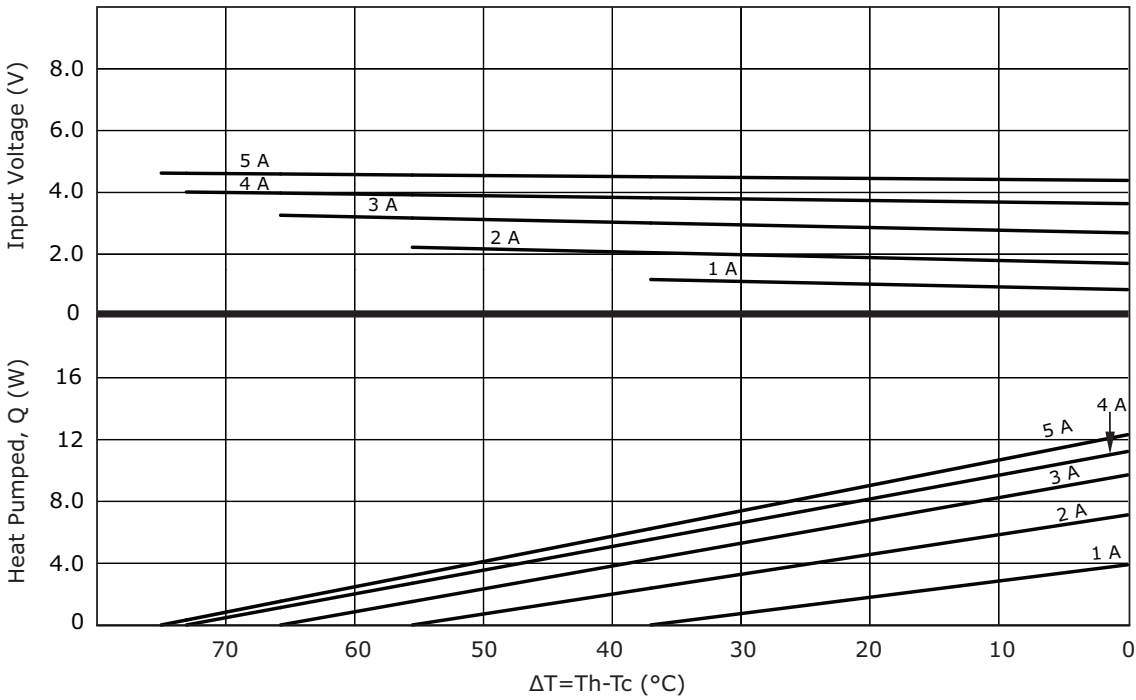

CP50341 PERFORMANCE (Th=27°C)

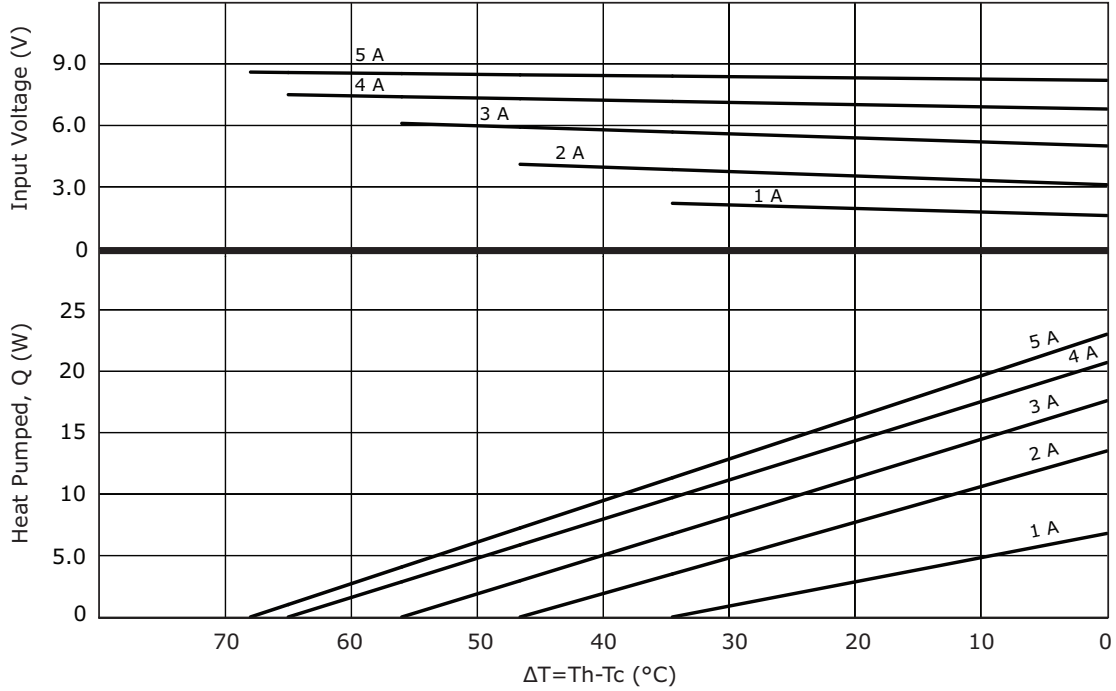

CP50341 PERFORMANCE (Th=50°C)

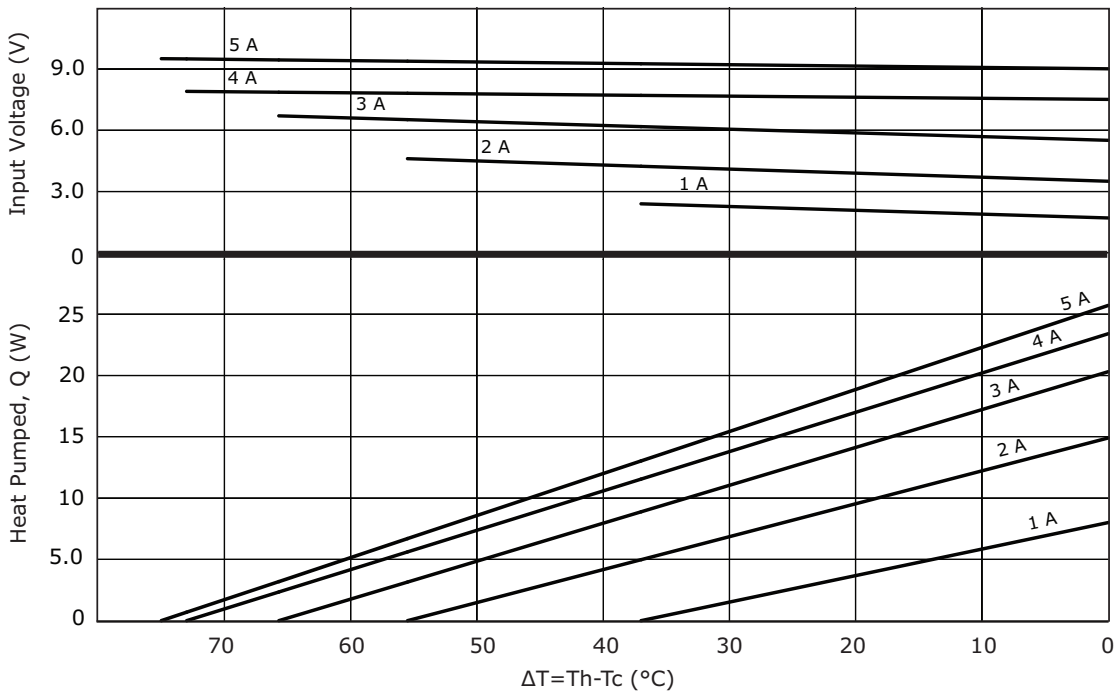

CP50441 PERFORMANCE (Th=27°C)

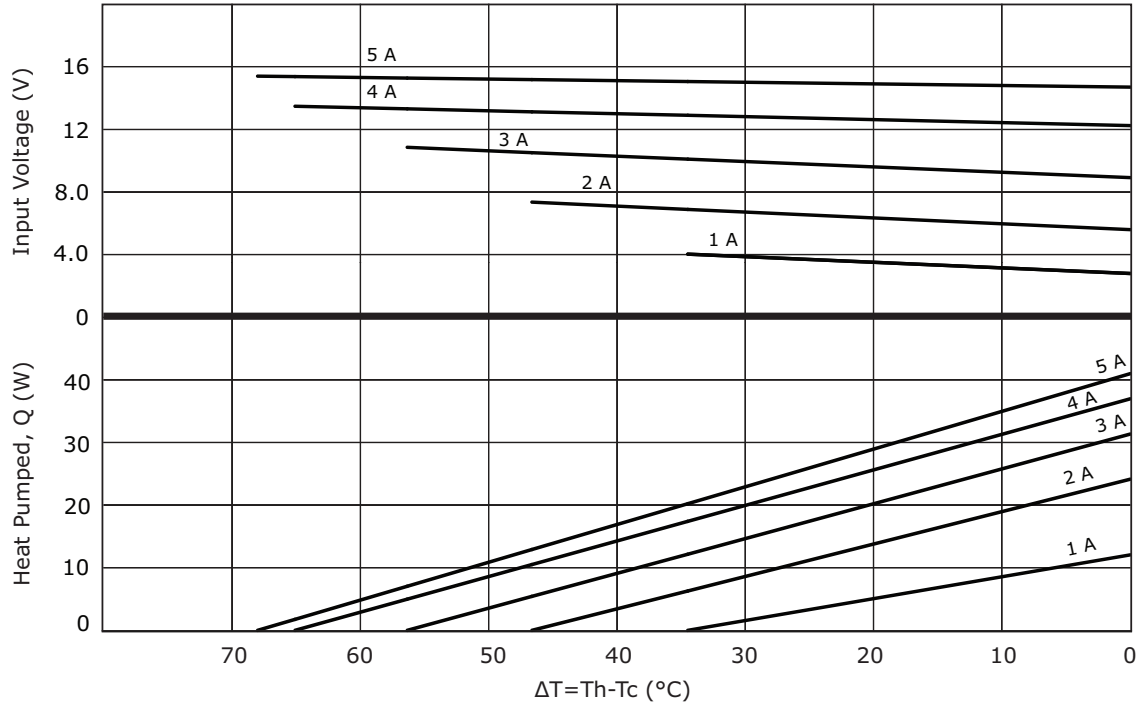

CP50441 PERFORMANCE (Th=50°C)

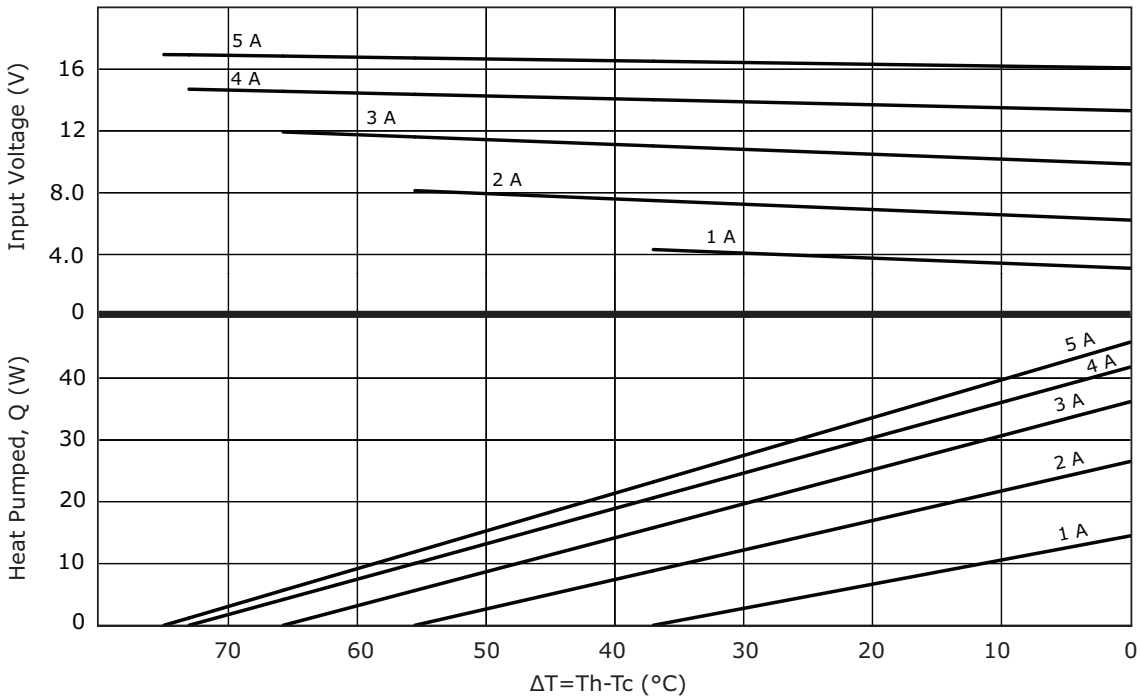

REVISION HISTORY

rev.	description	date
1.0	initial release	09/06/2016

The revision history provided is for informational purposes only and is believed to be accurate.



Headquarters
20050 SW 112th Ave.
Tualatin, OR 97062
800.275.4899

Fax 503.612.2383
cui.com
techsupport@cui.com

CUI offers a one (1) year limited warranty. Complete warranty information is listed on our website.

CUI reserves the right to make changes to the product at any time without notice. Information provided by CUI is believed to be accurate and reliable. However, no responsibility is assumed by CUI for its use, nor for any infringements of patents or other rights of third parties which may result from its use.

CUI products are not authorized or warranted for use as critical components in equipment that requires an extremely high level of reliability. A critical component is any component of a life support device or system whose failure to perform can be reasonably expected to cause the failure of the life support device or system, or to affect its safety or effectiveness.