

D.C. direct drive motors Ø 42 mm and 63 mm

- For high-power drive applications
- Maximum usable power : from 14 to 67 W
- Ø 42 mm : Sintered bronze bearings lubricated for life
Supply connection by 2 leads
- Long service life motors :
 - Ø 63 mm : With 2 ball bearings
Supply connection by 2 leads

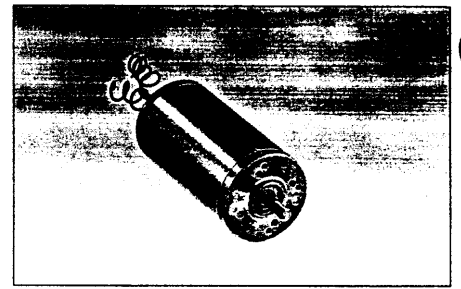

Applications

- Gas analysers
- Pumps/vacuum devices
- Cash registers
- Printers
- Mixers for automatic drink dispensers
- Compressors
- Spindle drives for engraving machines
- Document sorters
- Automatic swimming-pool cleaners
- Filtering systems
- Water circulators for whirlpool baths
- Paper drives for photocopiers
- Opening/closing of automatic doors
- Machines for making spectacle lenses

Made to order products available on request

- integrated interference suppression
- other supply voltages
- shaft lengths at front and/or rear
- motor with 1 or 2 ball bearings (82 850)
- other front and rear fixing plates
- optical encoder 200 pulses per revolution

Type	82 800 8	32 800 8	82 850 0	82 850 0	
Nominal voltage	12 V	24 V	12 V	24 V	
Part number	82 800 801	82 800 802	82 850 001	82 850 002	
Standard Characteristics					
Speed	rpm	3920	4010	4150	4050
Absorbed power	W	9.96	12.24	7.32	7.44
Absorbed current	A	0.83	0.51	0.61	0.31
Characteristics - nominal					
Speed	rpm	2670	3070	3100	3200
Torque	mN.m	70	70	100	100
Output power	W	20	22	32.5	33.5
Absorbed power	W	37	41	51	52
Absorbed current	A	3.05	1.71	4.25	2.15
Gearbox case temperature rise	°C	38	40	63	54
Efficiency	%	54	54	63	64
General characteristics					
Insulation class	F	F	F	F	
(conforming to IEC 85)	(155 °C)	(155 °C)	(155 °C)	(155 °C)	
Degree of protection (IEC 529)	IP20	IP20	IP20	IP20	
Maximum usable power	W	22	31	42	52
Start torque	mN.m	219	298	390	490
Start current	A	9	6.16	14.8	9.6
Resistance	Ω	1.33	3.9	0.81	2.5
Resistance : inductive	mH	2.67	9.35	0.7	2.5
Torque constant	Nm/A	0.0268	0.0527	0.027	0.052
Electrical time constant	ms	2	2.4	0.85	1
Mechanical time constant	ms	20	15	16	13
Thermal time constant	min	12	12	26	21
Inertia	g.cm ²	105	110	140	140
Weight	g	400	400	640	640
No of segments		8	8	8	8
Life	h	3000	3000	3000	3000
Ball bearings					
Sintered bronze bearings	yes	yes	yes	yes	
Lead length	mm	200	200	200	200

A - Torque/Speed curves B - Torque/Current curves

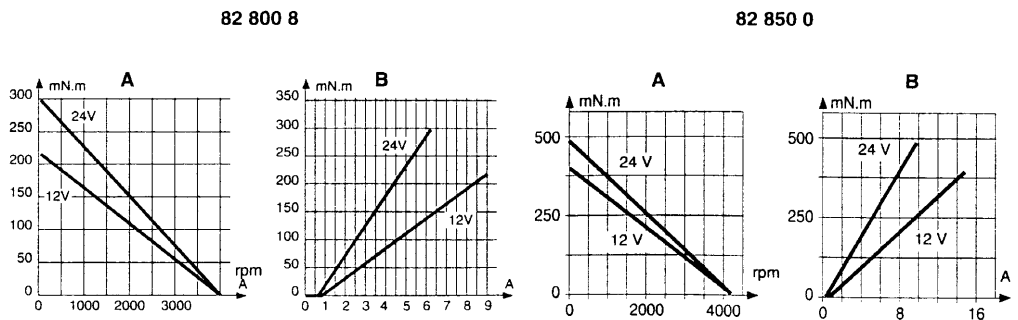

Other information

Basic principles see page 1/4.

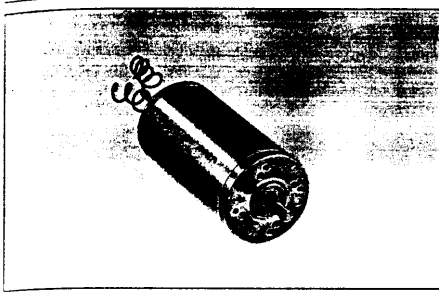

82 890 0 82 890 0

24 V 48 V

82 890 001 **82 890 002**

3700	3750
10.8	9.6
0.45	0.2

3200	3360
270	270
90	95
120	118
5.00	2.45
50	50
75	80

F (155 °C)	F (155 °C)
IP20	IP20
194	255
2000	2600
34.1	21.7
0.7	2.2
1.05	4.62
0.059	0.12
1.5	2.1
16	12
41	36
795	795
1580	1580
12	12
5000	5000
yes	yes
200	200

A - Torque/Speed curves
B - Torque/Current curves

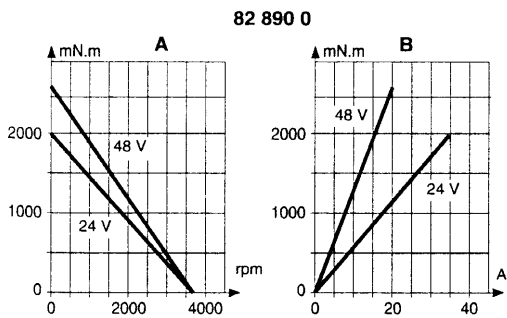

Dimensions : 82 890 0

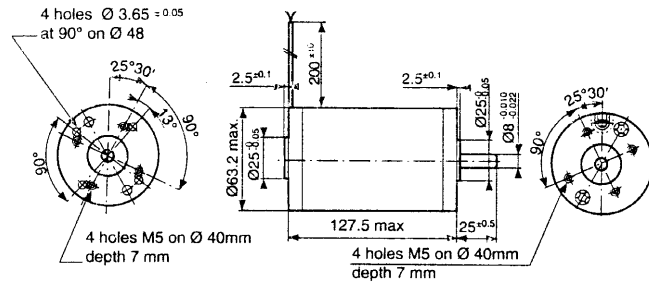

Dimensions : 82 800 8

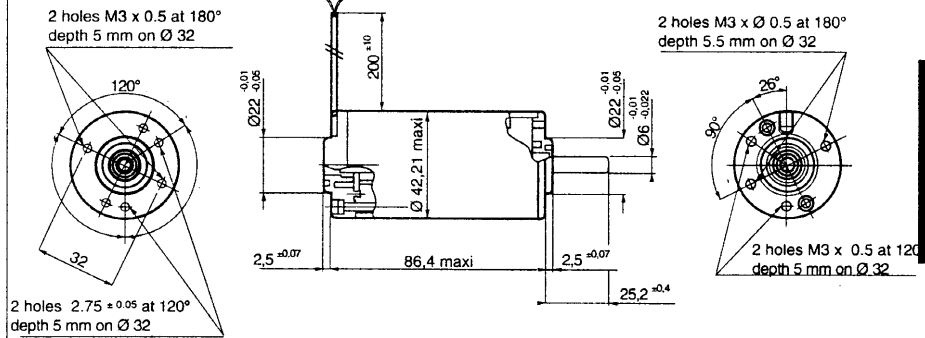

Dimensions : 82 850 0

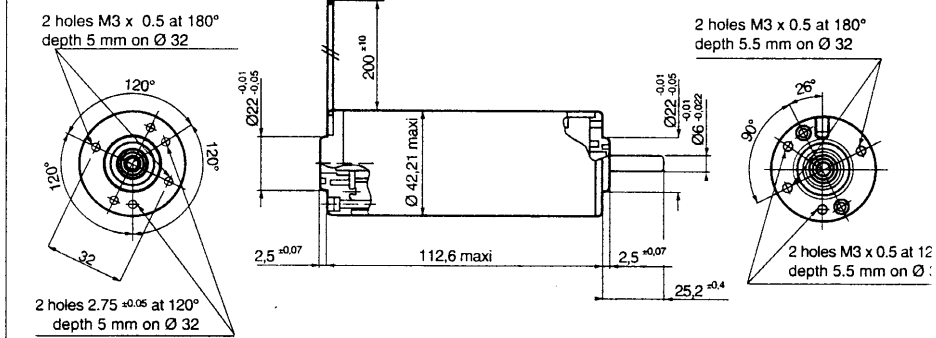

To order, specify :

Standard products Part number
Example : D.C. direct drive motor - 82 890 001

Standard products, non stocked Part number
Example : D.C. direct drive motor - 82 800 802 - 24 volts

Some principles of direct current (D.C.) motors

1 - Why choose a D.C. motor?

Many applications call for a high start-up torque. The D.C. motor, by its very nature, has a high torque vs. falling speed characteristic and this enables it to deal with high starting torques and to absorb sudden rises in load easily. The speed of the motor adjusts to the load. Furthermore, the D.C. motor is an ideal way of achieving the miniaturisation designers are constantly seeking because the efficiency it gives is high compared with other designs.

2 - Design of Crouzet D.C. motors

2.1 Safety

Crouzet D.C. motors are designed and manufactured for integration into equipment or machines which meet, for example, the requirements of the machinery standard :

EN 60335-1 (IEC 335-1, "Safety of domestic electrical appliances"). Integration of Crouzet D.C. motors into equipment or machines should, as a rule, take the following motor characteristics into account :

- no ground connection
- so-called "principal insulation" motors (single insulation)

- protection index : IP00 to IP40
- insulation classes : A to F

(see the catalogue page details for individual motor types)

EC LOW VOLTAGE DIRECTIVE 73/23/EEC OF 19/02/73 :

Crouzet D.C. motors and geared motors are not covered by this directive (LVD 73/23/EEC applies to voltages greater than 75 VDC).

2.2 Electromagnetic compatibility (EMC)

Crouzet Ltd can provide the EMC characteristics of the various types of product on request.

EC DIRECTIVE 89/336/EEC OF 03/05/89,

"ELECTROMAGNETIC COMPATIBILITY" :

D.C. motors and geared motors are considered as components meant for integration into other equipment and therefore fall outside its field of application. However, these products are designed in compliance with EMC characteristics and consequently can be incorporated in equipment having to comply with the EMC directive.

3 - How to select from the Crouzet range

The motor unit is selected according to the required output power.

Depending on the required speed, a direct motor or a geared motor is selected.

- Speeds 1,000 to 5,000 rpm → Direct motor
- Speeds below 500 rpm → Geared motor

The gearbox is selected depending on the maximum required torque and the duty cycle.

4 - Definition of the D.C. motor

This motor follows linear laws of operation and because of this it is easier to fully exploit its characteristics compared to synchronous or asynchronous motors.

Composition of a D.C. motor

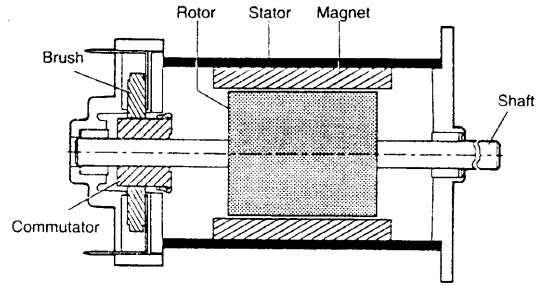

The stator is formed by a metal carcass and one or more magnets that create a permanent magnetic field inside the stator. At the rear of the stator are the brush mountings and the brush gear which provide electrical contact with the rotor.

The rotor is itself formed by a metal carcass carrying coils which are interconnected at the commutator at the rear of the rotor.

The commutator and brush assembly then select the coil through which the electric current passes in the opposite direction.

Principle of operation

Whatever the complexity of the rotor coil windings, once they are energised, they may be represented in the form of a ferromagnetic cylinder with a solenoid wrapped around it.

The wire of the solenoid is in practice the wire bundle located in each groove of the rotor. The rotor, when energised, then acts as an electromagnet, the magnetic field following the axis separating the wires of the solenoid in the direction of the current which flows through them.

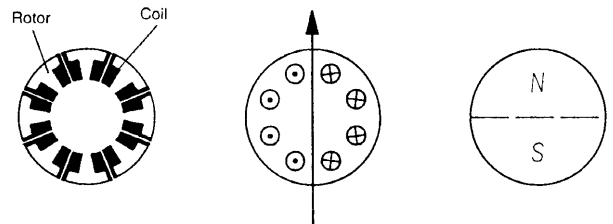

The motor, therefore, consists of fixed permanent magnets (the stator) a moving magnet (the rotor) and a metal carcass to concentrate the flux (the motor body).

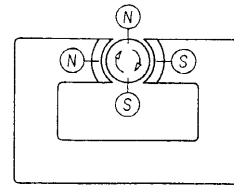

By the attraction of opposite poles and repulsion of like poles, a torque then acts on the rotor and makes it turn. This torque is at a maximum when the axis between the poles of the rotor is perpendicular to the axis of the poles of the stator.

As soon the rotor begins to turn, the fixed brushes make and break contact with the rotating commutator segments in turn.

The rotor coils are then energised and de-energised in such a way that as the rotor turns, the axis of a new pole of the rotor is always perpendicular to that of the stator. Because of the way the commutator is arranged, the rotor is in constant motion, no matter what its position. Fluctuation of the resultant torque is reduced by increasing the number of commutator segments, thereby giving smoother rotation.

By reversing the power supply to the motor, the current in the rotor coils, and therefore the north and south poles, is reversed. The torque which acts on the rotor is thus reversed and the motor changes its direction of rotation. By its very nature, the D.C. motor is a motor with a reversible direction of rotation.

Torque and speed of rotation

The torque generated by the motor, and its speed of rotation, are dependent on each other.

This is a basic characteristic of the motor ; it is a linear relationship and is used to calculate the no-load speed and the start-up torque of the motor.

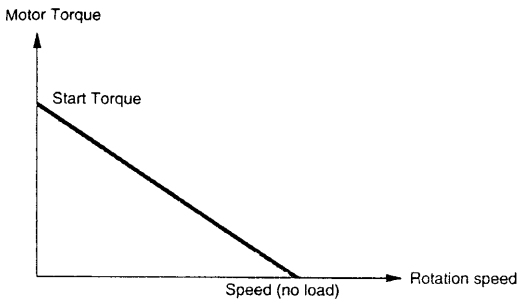

The curve for the output power of the motor is deduced from the graph of torque versus speed.

$$P_u (W) = \frac{2p}{60} \times C (N.m) \times N (rpm)$$

Output power	Motor torque	Speed of rotation
--------------	--------------	-------------------

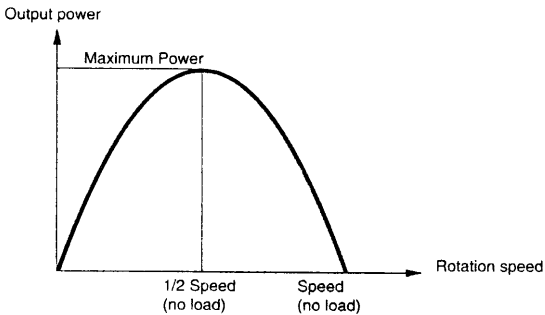

The torque vs. speed and output power curves depend on the supply voltage to the motor.

The supply voltage to the motor assumes continuous running of the motor at an ambient temperature of 20°C in nominal operational conditions.

It is possible to supply the motor with a different voltage (normally between -50% and + 100% of the recommended supply voltage). If a lower voltage is used compared to the recommended supply the motor will be less powerful. If a higher voltage is used, the motor will have a higher output power but will run hotter (intermittent operation is recommended).

For variations in supply voltage between approximately - 25% to + 50%, the new torque vs. speed graph will remain parallel to the previous one. Its start-up torque and no-load speed will vary by the same percentage (n%) as the variation in supply voltage. The maximum output power is multiplied by $(1 + n\%)^2$.

Example : For a 20% increase in supply voltage

- Start-up torque increases by 20% (x 1.2)
- No-load speed increases by 20% (x 1.2)
- Output power increases by 44% (x 1.44)

Torque and supply current

This is the second important characteristic of a D.C. motor.

It is linear and is used to calculate the no-load current and the current with the rotor stationary (start-up current).

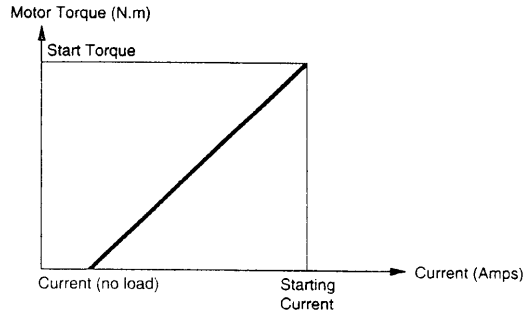

The graph for this relationship does not vary with the supply voltage of the motor. The end of the curve is extended in accordance with the torque and the start-up current.

The gradient of this curve is called the "torque constant" of the motor.

$$K_c = \frac{C_d}{I_d - I_0}$$

This torque constant is such that :

$$C = K_c (I - I_0)$$

The "rotational friction torque" is $K_c I_0$.

The torque is therefore expressed as follows :

$$C = K_c I - C_f \text{ with } C_f = K_c I_0$$

K_c = Torque constant (Nm/A)
 C = Torque (Nm)
 C_d = Start-up Torque (Nm)
 C_f = Rotational friction torque (Nm)
 I = Current (A)
 I_0 = No-load current (A)
 I_d = Start-up current (A)

The graph of torque vs. current and torque vs. speed is used to determine the absorbed power as a function of the speed of rotation of the motor.

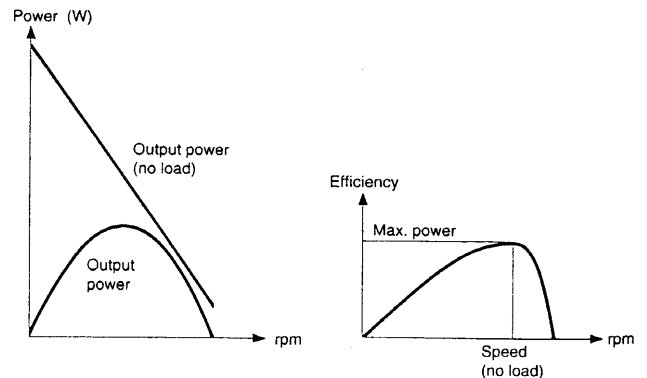

Efficiency

The efficiency of a motor is equal to the mechanical output power that it can deliver, divided by the power which it absorbs.

The output power and the absorbed power vary in relation to the speed of rotation, therefore the efficiency is also a function of the speed of the motor.

Maximum efficiency is obtained with a given rotational speed greater than 50% of no-load speed.

Temperature rise

The temperature rise of a motor is due to the difference between the absorbed power and the output power of the motor. This difference is the power loss.

Temperature rise is also related to the fact that power loss, in the form of heat from the motor, is not rapidly absorbed by the ambient air (thermal resistance). The thermal resistance of the motor can be greatly reduced by ventilation.

Important

The nominal operating characteristics correspond to the voltage-torque-speed characteristics required for continuous operation at an ambient temperature of 20° C. Only intermittent duty is possible outside these operating conditions : without exception, all checks concerning extreme operating conditions must be performed in the actual customer application conditions in order to ensure safe operation.

5 - Motor and gearbox combinations

D.C. motors are constructed to operate continuously within a range of speeds near their no-load speed. This range of speeds is generally too high for most applications. In order to reduce this speed, a full range of geared motors is available, each with a series of gear ratios to suit most speed requirements.

The complete range is suitable for a wide variety of applications.

Gearbox characteristics

Our gearboxes have been designed for optimum performance and for maximum life under normal operating conditions.

Their main characteristic is the capacity to withstand **maximum design torque with continuous duty.**

The range of gearboxes shown in this catalogue can operate with maximum torque of **0.5 to 6 N.m** for long time periods. All values previously stated are for standard products in normal operating conditions, as specified.

In certain cases, these values may be increased if a shorter life is required.

Please consult our Sales Office for further information.

Every gearbox has a torque limit, which is **the breaking torque**

If this torque is applied to the gearbox, it will cause severe damage.

Gearbox construction

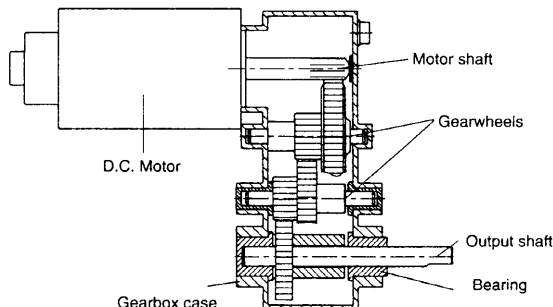

Selection of a geared motor

A geared motor is selected according to the required usable power output.

$$P_{\text{usable}} = \frac{2 \pi \cdot C \cdot n}{60} \cdot W$$

Nm rpm

A geared motor must have usable power equal to or greater than the power required to rotate the load. It is selected by checking that the point corresponding to the required operating conditions (torque and speed output) is higher than the nominal torque versus speed curve of the geared motor.

The required torque output of a geared motor must be within its maximum recommended torque for continuous duty.

Selecting the reduction gear ratio

Two selection criteria may be applied.

- The first criterion concerns the required speed output of the reduction gear only. It is adequate for most applications and is easy to apply. Given that :

$$R = \frac{N1}{Nb}$$

N1 = required speed of geared motor
Nb = basic nominal speed of motor

- The second criterion concerns the required usable power output of the motor. The rotational speed of the motor is given by :

$$N = 1/2 (No + \sqrt{No^2 - \frac{4P}{A}}) \text{ with } A = \frac{\pi Cd}{30No}$$

N = speed of motor (rpm)
No = no-load speed of motor (rpm)
P = required output power (W)
Cd = start-up torque of motor (Nm)

This gives the equation : $R = \frac{N1}{N}$

In order to avoid using numbers less than 1 where the reduction ratio is concerned, the value 1/R is employed. Due to the fact that it is always a reduction gear and not a "multiplier" gear, there should be no ambiguity concerning the number used.

$$1/R = \frac{Nb}{N1} \text{ or } 1/R = \frac{N}{N1}$$