

used for: D-SUB COMBINATION

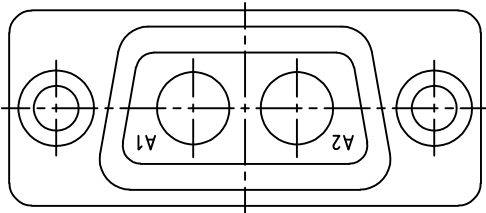
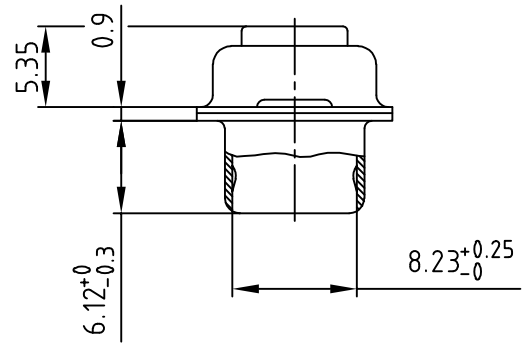
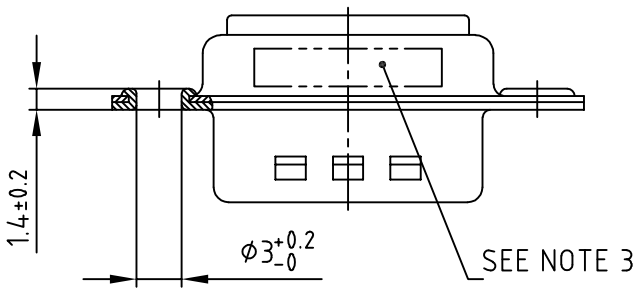
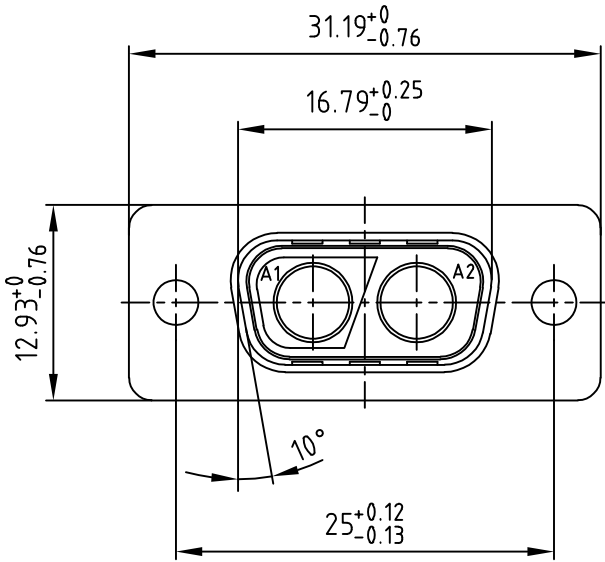

NOTES:

1. METALSHELLS: STEEL: TIN PLATED
2. INSULATOR: PBTP GF UL 94 V-0; GREEN
3. CONNECTOR IS PART MARKED: PART-NO. CONEC ABC

RoHS compliant

THIS DRAWING MAY NOT BE COPIED OR REPRODUCED IN ANY WAY, AND MAY NOT BE PASSED ON TO A THIRD PARTY WITHOUT WRITTEN PERMISSION.
 OWNERSHIP AND COPYRIGHT OF CONEC GmbH
 DO NOT ALTER CAD DRAWING BY HAND

tolerance					
1998	date	name			
drawn	16.10.	Barcinski			
appd.	16.10.	Mickenbecker			
norm					
d-old					
rev.	description	date	name		



scale:	2:1	
material:	SEE NOTES	
title:	D-SUB COMBINATION MALE 2W2CP WITHOUT CONTACTS	
dwg no:	AutoCAD/REL.13	DIN-A
	13K1J8A	4
part no:	302W2CPXX99A10X	
		sh: 1/1