

CDSP400-G

RoHS Device

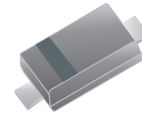

Features

- Small surface mounting type.
- High speed.
- High reliability with high surge current handling capability.

Mechanical Data

- Case: Molded plastic SOD-723
- Terminals: Solderable per MIL-STD-750, Method 2026.
- Polarity: Indicated by cathode band.
- Mounting position: Any.

Circuit diagram

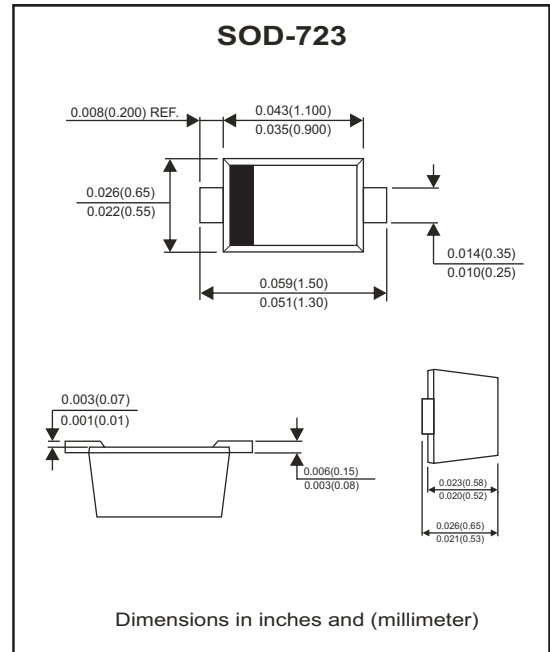

Maximum Ratings (at Ta=25°C unless otherwise noted)

Parameter	Symbol	Value	Unit
Non-Repetitive peak reverse voltage	V_{RM}	90	V
DC blocking voltage	V_R	80	V
Forward continuous current	I_{FM}	225	mA
Average rectified output current	I_o	100	mA
Non-Repetitive peak forward surge current@ t=8.3ms	I_{FSM}	2.0	A
Power dissipation	P_D	100	mW
Thermal resistance junction to ambient	$R_{\theta JA}$	1250	°C/W
Junction temperature range	T_J	150	°C
Storage temperature range	T_{STG}	-55 to +150	°C

Electrical Ratings (at Ta=25°C unless otherwise noted)

Parameter	Conditions	Symbol	Min.	Typ.	Max.	Unit
Forward voltage	$I_F=100mA$	V_F			1.2	V
Reverse current	$V_R=80V$	I_R			0.1	μA
Capacitance between terminals	$V_R=0.5V, f=1MHz$	C_T			3	pF
Reverse recovery time	$V_R=6V, I_F=10mA, R_L=100\Omega$	t_{rr}			4	nS

ELECTRICAL CHARACTERISTIC CURVES (CDSP400-G)

Fig.1 - Forward Characteristics

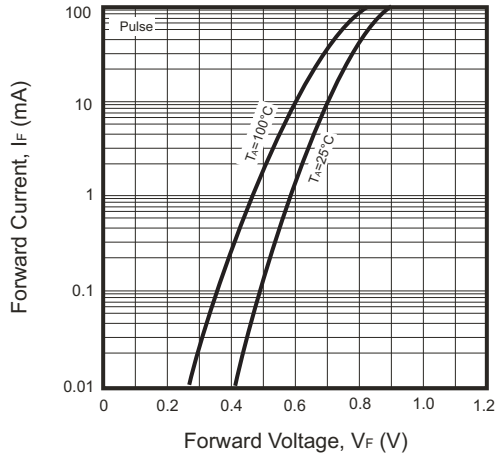

Fig.2 - Reverse Characteristics

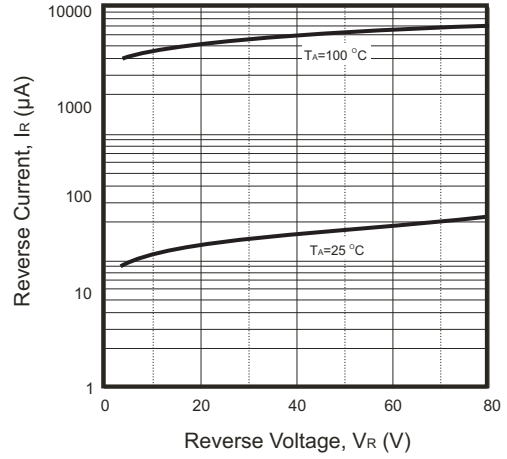

Fig.3 - Capacitance Between Terminals Characteristics

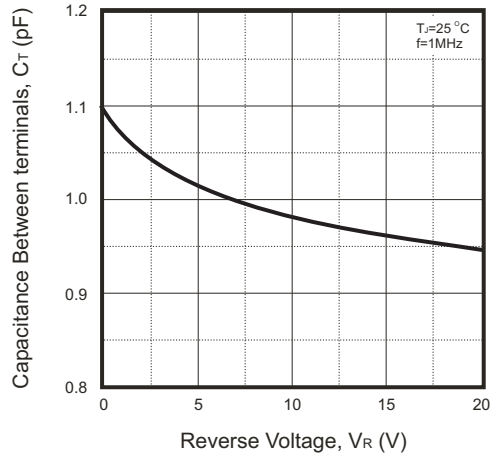
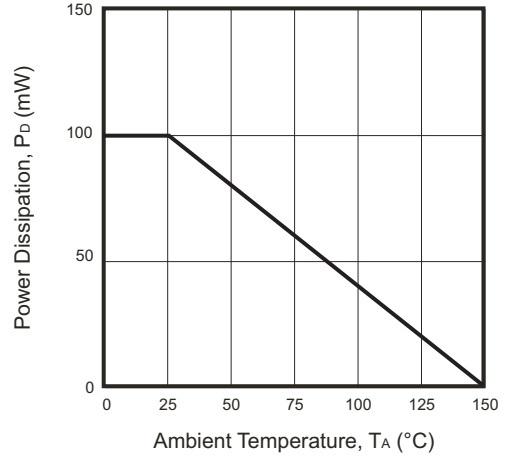
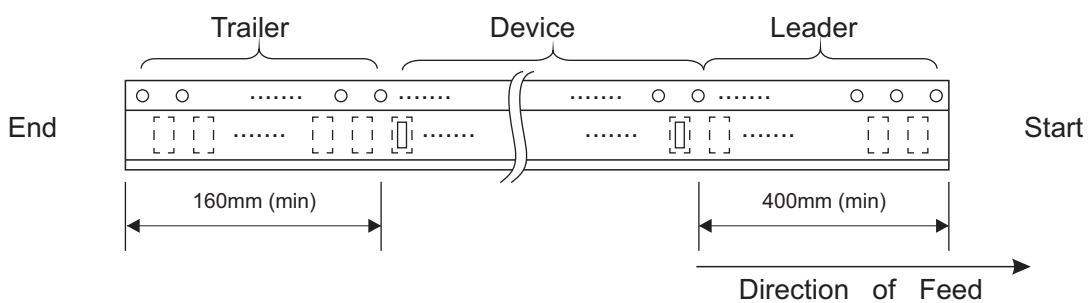
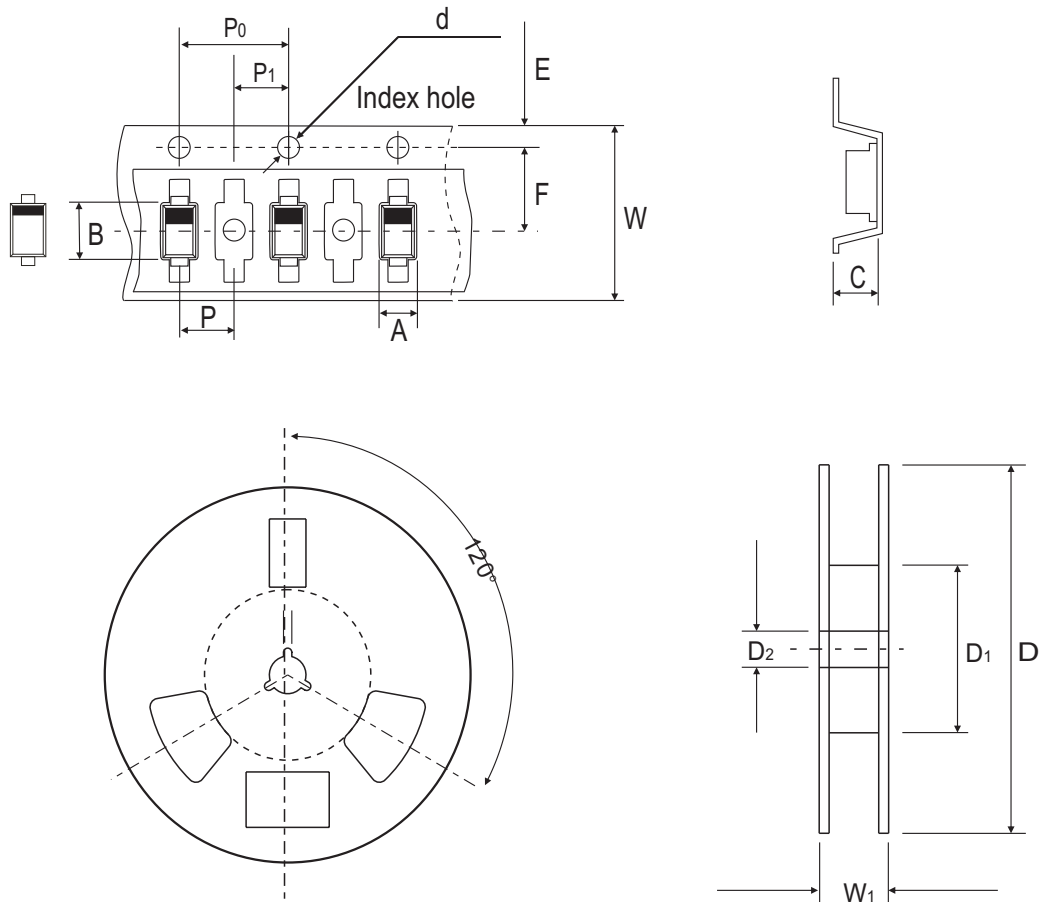

Fig.4 - Power Derating Curve



Reel Taping Specification



SOD-723	SYMBOL	A	B	C	d	D	D1	D2
	(mm)	0.70 ± 0.05	1.71 ± 0.05	0.68 ± 0.05	1.50 ± 0.10	178.00 ± 2.00	54.40 ± 1.00	13.00 ± 1.00
	(inch)	0.028 ± 0.002	0.067 ± 0.002	0.027 ± 0.002	0.059 ± 0.004	7.008 ± 0.079	2.142 ± 0.039	0.512 ± 0.039

SOD-723	SYMBOL	E	F	P	P0	P1	W	W1
	(mm)	1.75 ± 0.10	3.50 ± 0.10	4.00 ± 0.10	2.00 ± 0.10	2.00 ± 0.10	8.00 ± 0.30 / - 0.10	12.30 ± 1.00
	(inch)	0.069 ± 0.004	0.138 ± 0.004	0.158 ± 0.004	0.079 ± 0.004	0.079 ± 0.004	0.315 ± 0.012 / - 0.004	0.484 ± 0.039

Marking Code

Part Number	Marking Code
CDSP400-G	7



Suggested PAD Layout

SIZE	SOD-723	
	(mm)	(inch)
A	1.26	0.050
B	0.60	0.024
C	0.70	0.028
D	1.86	0.073
E	0.66	0.026

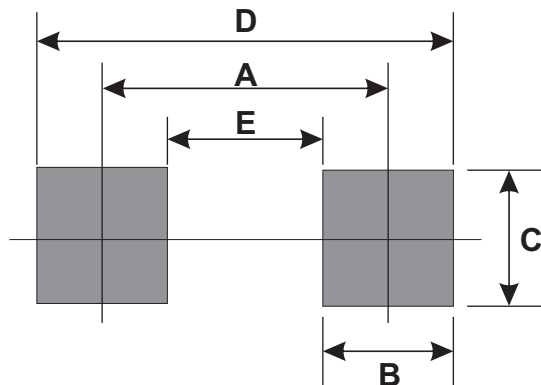

Standard Packaging

Case Type	REEL PACK	
	REEL (pcs)	Reel Size (inch)
SOD-723	8,000	7