

## CDBT-40/S/C/A-G

**Reverse Voltage: 40 Volts**  
**Forward Current: 200 mA**  
**RoHS Device**

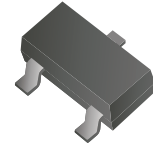

### Features

- Design for mounting on small surface.
- High speed switching application, circuit protection.
- Low forward voltage drop.

### Mechanical data

- Case: SOT-23, molded plastic.
- Terminals: Solderable per MIL-STD-750, method 2026.
- Weight: 0.0078 grams(approx.).

### Circuit diagram



CDBT-40-G Marking Code: 43    CDBT-40S-G Marking Code: 44    CDBT-40C-G Marking Code: 45    CDBT-40A-G Marking Code: 46

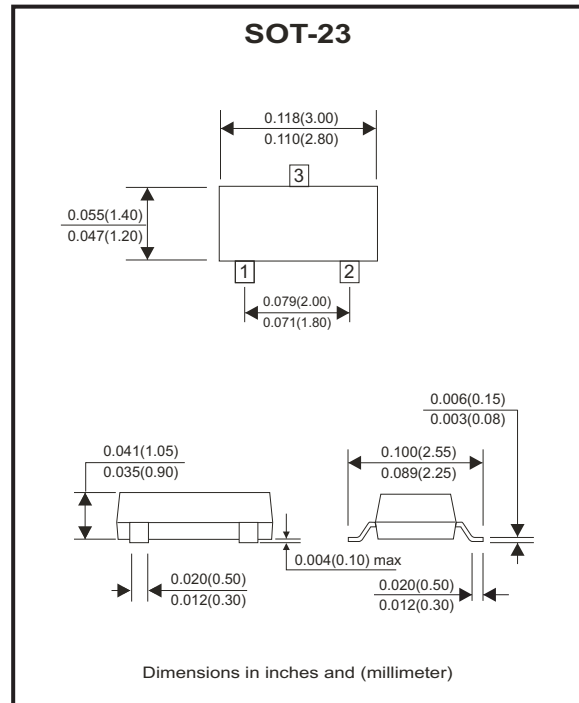

### Maximum Ratings (at Ta=25°C unless otherwise noted)

Parameter	Symbol	Conditions	Value	Unit
Peak repetitive peak reverse voltage	$V_{RRM}$		40	V
Working peak reverse voltage	$V_{RWM}$			
DC blocking voltage	$V_R$			
Forward continuous current	$I_F$		200	mA
Power dissipation	$P_D$		200	mW
Thermal resistance	$R_{\theta JA}$	Junction to ambient	500	°C/W
Junction temperature	$T_J$		125	°C
Storage temperature range	$T_{STG}$		-55 to +150	°C

### Electrical Characteristics (at Ta=25°C unless otherwise noted)

Parameter	Symbol	Conditions	Min.	Max.	Unit
Reverse breakdown voltage	$V_{BR}$	$I_R=10\mu A$	40		V
Reverse voltage leakage current	$I_R$	$V_R=30V$		200	nA
Forward voltage	$V_F$	$I_F=1mA$		380	mV
		$I_F=40mA$		1000	
Diode capacitance	$C_D$	$V_R=0V, f=1MHz$		5	pF
Reverse recovery time	$T_{rr}$	$I_{rr}=1mA, I_F=I_R=10mA, R_L=100\Omega$		5	nS

## RATING AND CHARACTERISTIC CURVES (CDBT-40/S/C/A-G)

Fig.1 - Forward Characteristics

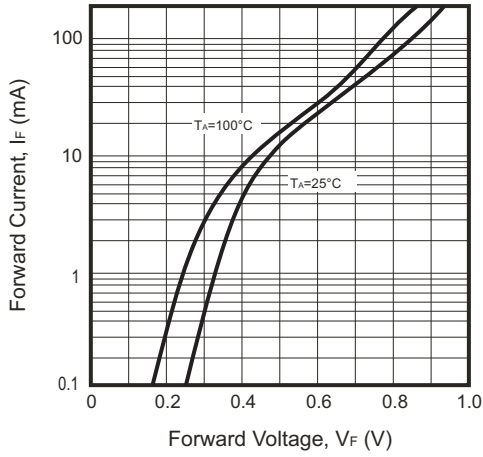

Fig.2 - Reverse Characteristics

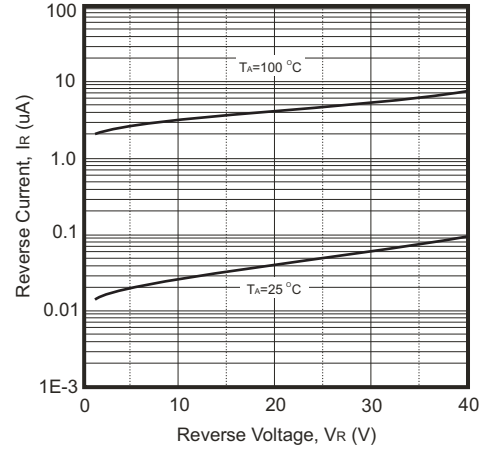

Fig.3 - Capacitance Characteristics

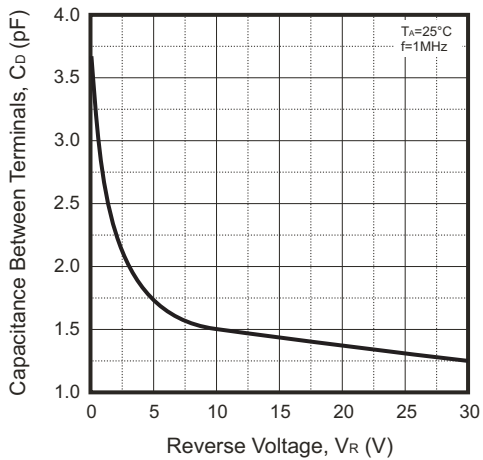
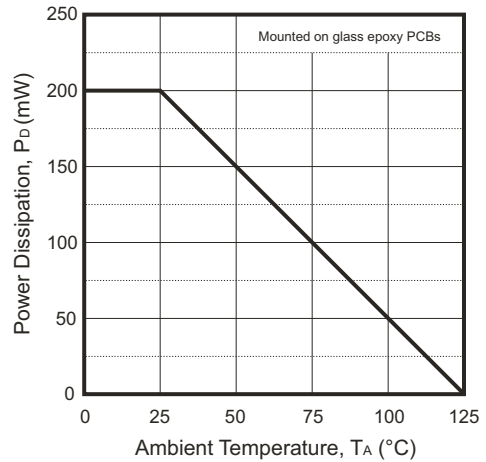
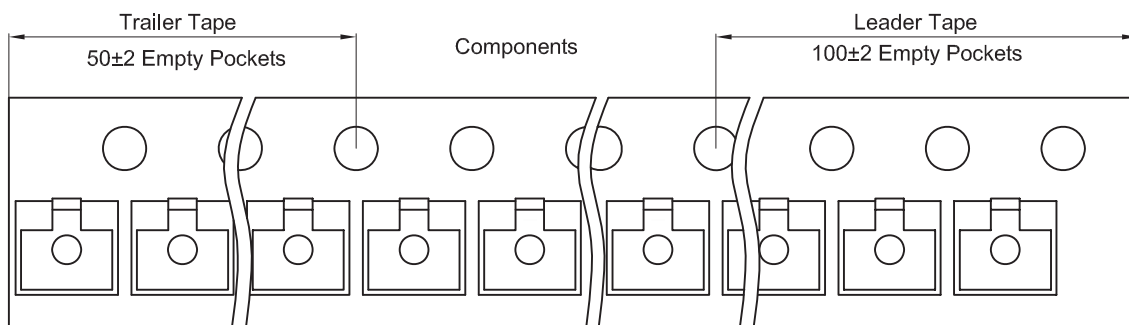
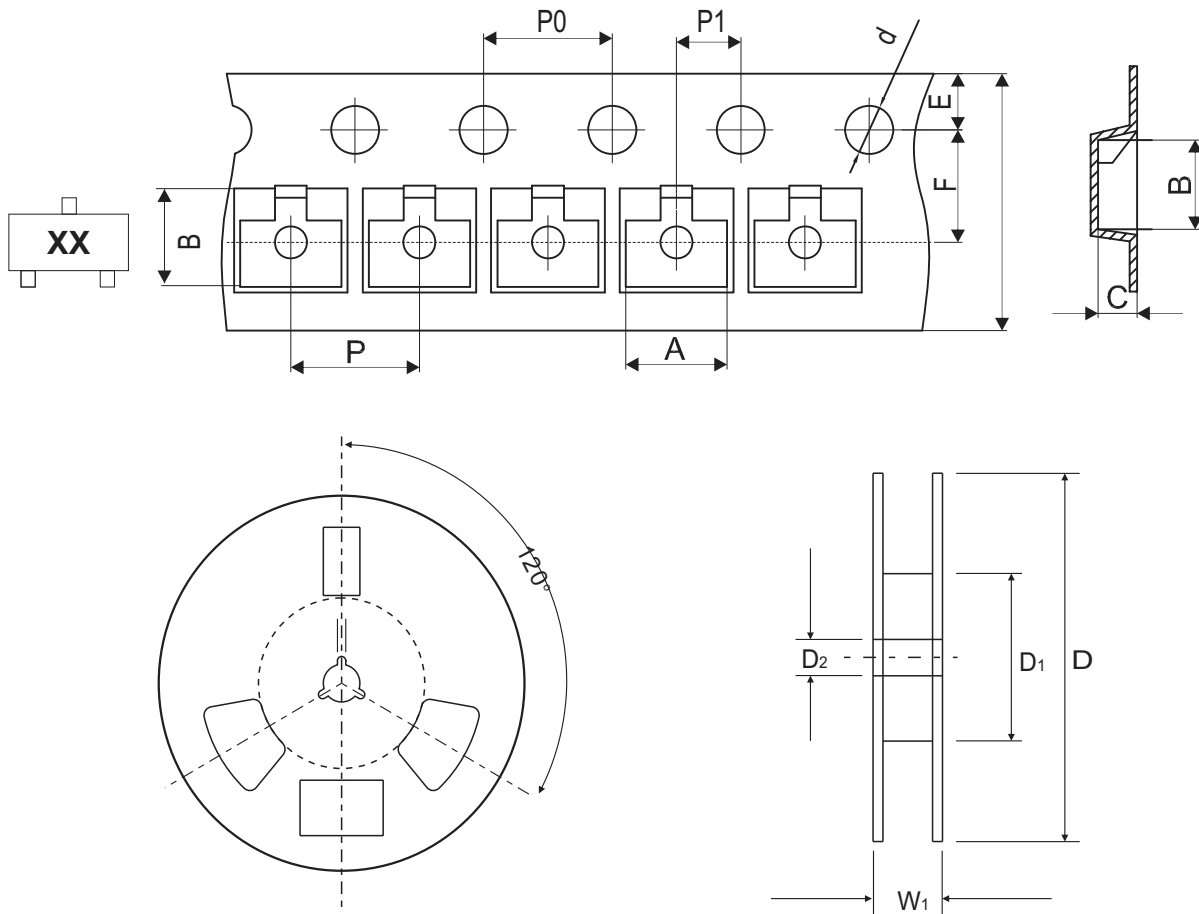

Fig.4 - Power Derating Curve



## Reel Taping Specification



SOT-23	SYMBOL	A	B	C	d	D	D1	D2
	(mm)	3.15 ± 0.10	2.77 ± 0.10	1.22 ± 0.10	1.50 ± 0.10	178.00 ± 2.00	54.40 ± 1.00	13.00 ± 1.00
	(inch)	0.124 ± 0.004	0.109 ± 0.004	0.048 ± 0.004	0.059 ± 0.004	7.008 ± 0.079	2.142 ± 0.039	0.512 ± 0.039

SOT-23	SYMBOL	E	F	P	P0	P1	W	W1
	(mm)	1.75 ± 0.10	3.50 ± 0.10	4.00 ± 0.10	4.00 ± 0.10	2.00 ± 0.10	8.00 + 0.30 / - 0.10	12.30 ± 1.00
	(inch)	0.069 ± 0.004	0.138 ± 0.004	0.157 ± 0.004	0.157 ± 0.004	0.079 ± 0.004	0.315 + 0.012 / - 0.004	0.484 ± 0.039

## Marking Code

Part Number	Marking Code
CDBT-40-G	43•
CDBT-40S-G	44
CDBT-40C-G	45
CDBT-40A-G	46

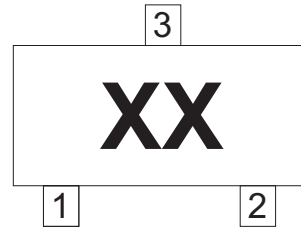

XX• / XX = Product type marking code

## Suggested PAD Layout

SIZE	SOT-23	
	(mm)	(inch)
A	0.80	0.031
B	0.60	0.024
C	1.90	0.075
D	2.02	0.080
E	2.82	0.111

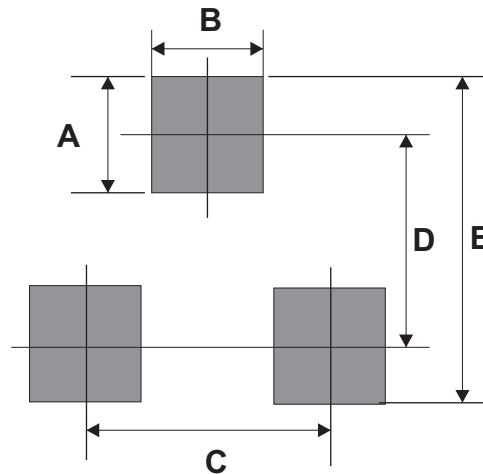

## Standard Packaging

Case Type	Qty Per Reel	Reel Size
	(Pcs)	(inch)
SOT-23	3,000	7