

# SDA Series Low Profile DIP Switches



DIP H

## Features/Benefits

- Low profile design saves space
- Thru-hole and surface mount models
- High pressure contact does not require tape seal for washing
- Tape and reel packaging available
- RoHS compliant

## Typical Applications

- Address switch for industrial controls
- Logic switching for computers and peripherals
- Function controlling for numerous applications

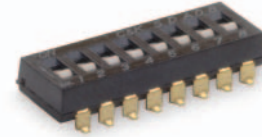

## Specifications

CONTACT RATING: 25 mA @ 24 V DC or 100 mA @ 5 V DC.  
 MECHANICAL AND ELECTRICAL LIFE: 1,000 cycles at rated loads.  
 CONTACT RESISTANCE: 50 mΩ max. initial.  
 INSULATION RESISTANCE: 100 MΩ between terminals.  
 DIELECTRIC WITHSTANDING VOLTAGE: 300 V DC min. for 1 minute.  
 STORAGE TEMPERATURE: -40°C to 85°C.  
 OPERATING TEMPERATURE: -40°C to 85°C.  
 OPERATING FORCE: 800 grams max.  
 SOLDERABILITY: Dip and look solderability testing per C&K spec. #448. Unplated edges of terminals permitted.  
 PACKAGING: Switches supplied in rigid dispensing tubes in full-tube quantities only, this may affect order quantity. Numbers of switches per tube varies with model. Tape and reel packaging also available for surface mount options.

## Materials

HOUSING: PPS, color black (UL94V-0).  
 COVER: PPS, color black (UL94V-0).  
 ACTUATOR: PA6T (UL94-0)  
 CONTACTS: Gold plated Beryllium copper.  
 TERMINALS: Gold plate over nickel plated brass.  
 TAPE SEAL: Polyimide.

**Note:** Specifications and materials listed above are for switches with standard options. For information on specific and custom switches, consult Customer Service Center. For Tin Lead options consult customer service center.

## How To Order

Complete part numbers for SDA Series are shown on pages H-8 through H-10. All switches supplied in "OFF" position.

## Flush Actuator – No Tape, Thru-hole Terminals



SDA08H0BD

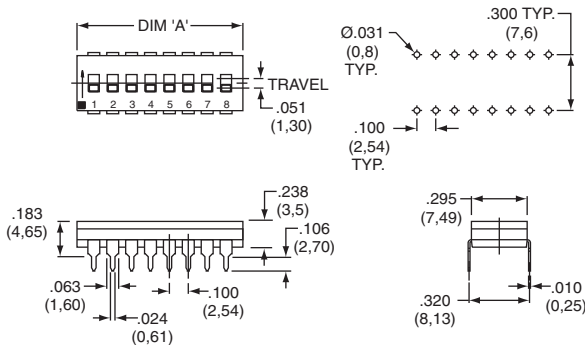

NOTE: SDA 01 options are 4,25mm thick

ROHS PART NUMBER	NO. POS.	DIM. 'A'	QUANTITY PER TUBE
<b>SDA01H0BD</b>	1	.178 (4,52)	100
<b>SDA02H0BD</b>	2	.278 (7,06)	60
<b>SDA03H0BD</b>	3	.378 (9,60)	45
<b>SDA04H0BD</b>	4	.476 (12,10)	35
<b>SDA05H0BD</b>	5	.578 (14,68)	30
<b>SDA06H0BD</b>	6	.676 (17,18)	25
<b>SDA07H0BD</b>	7	.778 (19,76)	20
<b>SDA08H0BD</b>	8	.876 (22,26)	20
<b>SDA09H0BD</b>	9	.978 (24,84)	15
<b>SDA10H0BD</b>	10	1.076 (27,34)	15
<b>SDA12H0BD</b>	12	1.279 (32,50)	14
Schematic			
SPST			

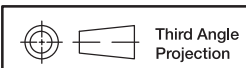

Third Angle Projection

Dimensions are shown: Inch (mm)  
 Specifications and dimensions subject to change



# SDA Series Low Profile DIP Switches



## Flush Actuator – With Top Tape, Thru-hole Terminals

ROHS PART NUMBER	NO. POS.	DIM. 'A'	QUANTITY PER TUBE
SDA01H0B	1	.178 (4,52)	100
SDA02H0B	2	.278 (7,06)	60
SDA03H0B	3	.378 (9,60)	45
SDA04H0B	4	.476 (12,10)	35
SDA05H0B	5	.578 (14,68)	30
SDA06H0B	6	.676 (17,18)	25
SDA07H0B	7	.778 (19,76)	20
SDA08H0B	8	.876 (22,26)	20
SDA09H0B	9	.978 (24,84)	15
SDA10H0B	10	1.076 (27,34)	15
SDA12H0B	12	1.279 (32,50)	14

Schematic

SPST

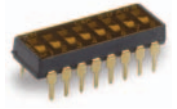
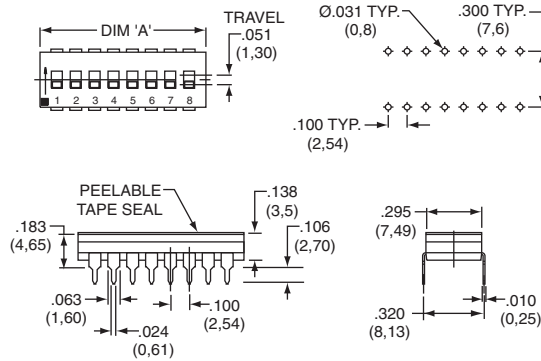

SDA08H0B

NOTE: SDA 01 options are 4,25mm thick

## Flush Actuator – With Top Tape, Surface Mount Terminals

ROHS PART NUMBER	NO. POS.	DIM. 'A'	QUANTITY PER TUBE
SDA01H0SB	1	.178 (4,52)	100
SDA02H0SB	2	.278 (7,06)	60
SDA03H0SB	3	.378 (9,60)	45
SDA04H0SB	4	.476 (12,10)	35
SDA05H0SB	5	.578 (14,68)	30
SDA06H0SB	6	.676 (17,18)	25
SDA07H0SB	7	.778 (19,76)	20
SDA08H0SB	8	.876 (22,26)	20
SDA09H0SB	9	.978 (24,84)	15
SDA10H0SB	10	1.076 (27,34)	15
SDA12H0SB	12	1.279 (32,50)	14

Schematic

SPST

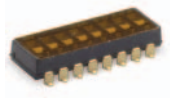
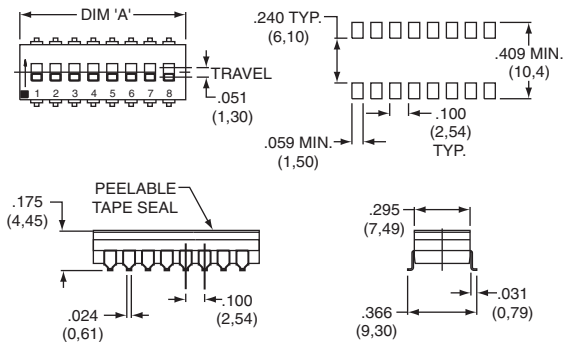

SDA08H0SB

NOTE: SDA 01 options are 4,25mm thick

## Flush Actuator – No Tape, Surface Mount Terminals

ROHS PART NUMBER	NO. POS.	DIM. 'A'	QUANTITY PER TUBE
SDA01H0SBD	1	.178 (4,52)	100
SDA02H0SBD	2	.278 (7,06)	60
SDA03H0SBD	3	.378 (9,60)	45
SDA04H0SBD	4	.476 (12,10)	35
SDA05H0SBD	5	.578 (14,68)	30
SDA06H0SBD	6	.676 (17,18)	25
SDA07H0SBD	7	.778 (19,76)	20
SDA08H0SBD	8	.876 (22,26)	20
SDA09H0SBD	9	.978 (24,84)	15
SDA10H0SBD	10	1.076 (27,34)	15
SDA12H0SBD	12	1.279 (32,50)	14

Schematic

SPST

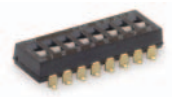
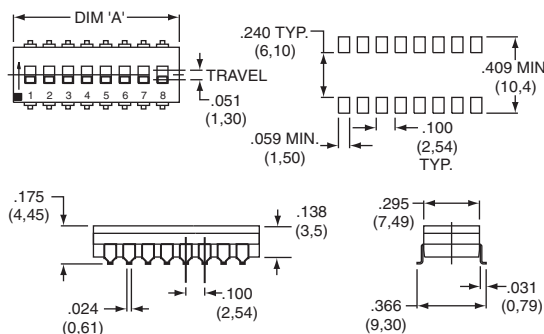

SDA08H0SBD

NOTE: SDA 01 options are 4,25mm thick

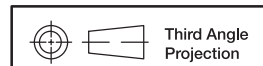

Dimensions are shown: Inch (mm)  
Specifications and dimensions subject to change



# SDA Series Low Profile DIP Switches

## Extended Actuator – No Top Tape, Thru-hole Terminals



SDA08H1BD

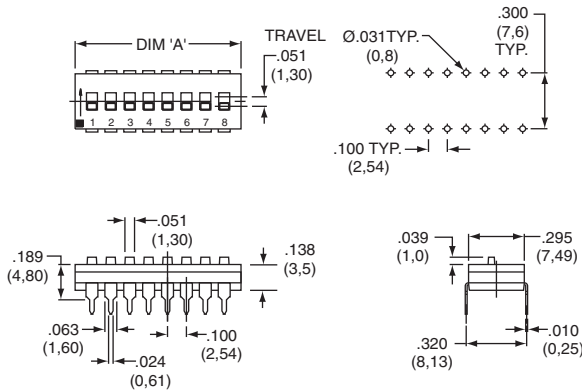

NOTE: SDA 01 options are 4,25mm thick

ROHS PART NUMBER	NO. POS.	DIM. 'A'	QUANTITY PER TUBE
SDA01H1BD	1	.178 (4,52)	100
SDA02H1BD	2	.278 (7,06)	60
SDA03H1BD	3	.378 (9,60)	45
SDA04H1BD	4	.476 (12,10)	35
SDA05H1BD	5	.578 (14,68)	30
SDA06H1BD	6	.676 (17,18)	25
SDA07H1BD	7	.778 (19,76)	20
SDA08H1BD	8	.876 (22,26)	20
SDA09H1BD	9	.978 (24,84)	15
SDA10H1BD	10	1.076 (27,34)	15
SDA12H1BD	12	1.279 (32,50)	14

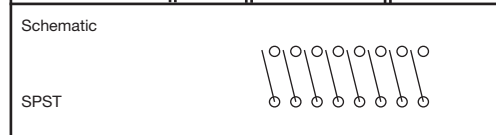

## Extended Actuator – No Top Tape, Surface Mount Terminals



SDA08H1SBD

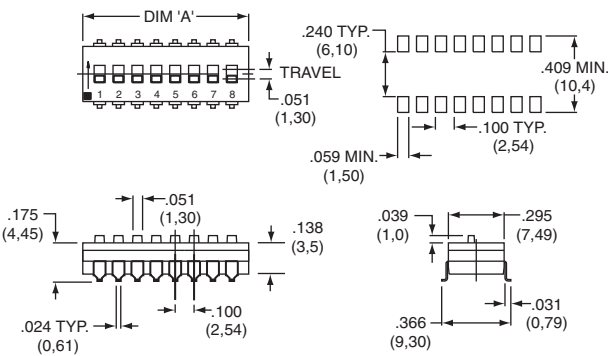

NOTE: SDA 01 options are 4,25mm thick

ROHS PART NUMBER	NO. POS.	DIM. 'A'	QUANTITY PER TUBE
SDA01H1SBD	1	.178 (4,52)	100
SDA02H1SBD	2	.278 (7,06)	60
SDA03H1SBD	3	.378 (9,60)	45
SDA04H1SBD	4	.476 (12,10)	35
SDA05H1SBD	5	.578 (14,68)	30
SDA06H1SBD	6	.676 (17,18)	25
SDA07H1SBD	7	.778 (19,76)	20
SDA08H1SBD	8	.876 (22,26)	20
SDA09H1SBD	9	.978 (24,84)	15
SDA10H1SBD	10	1.076 (27,34)	15
SDA12H1SBD	12	1.279 (32,50)	14

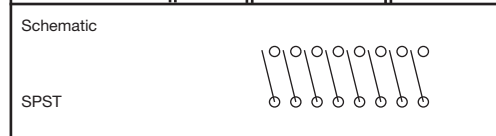

## Tape & Reel Packaging – Surface Mount Options only

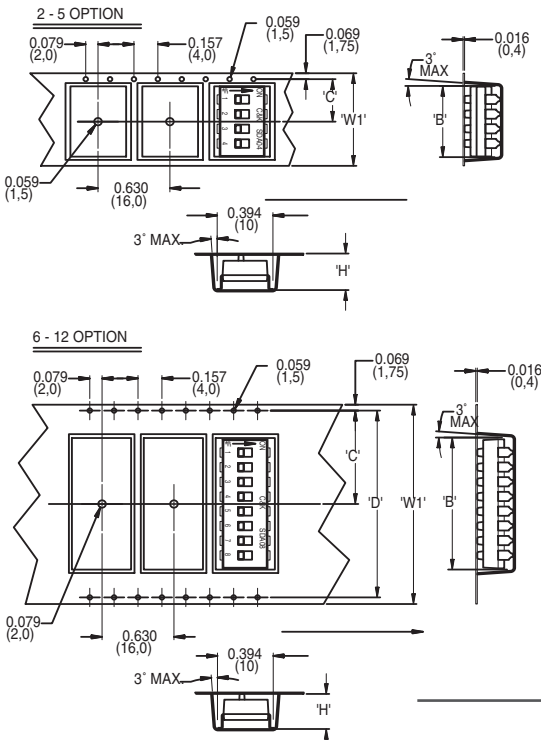

TAPE AND REEL PACKAGING  
SMT OPTIONS ONLY (ALL DIMS. ARE FOR REF. ONLY)

MODEL NO 'S' OPTION	MODEL NO 'S' OPTION	DIM. 'H' (REF.)	DIM. 'W1' (REF.)	DIM. 'W2' (REF.)	DIM. 'B' (REF.)	DIM. 'C' (REF.)	DIM. 'D' (REF.)	QUANTITY PER REEL
SDA02	H0	0.189 (4,8)	0.945 (24,0)	0.961 (24,4)	0.311 (7,9)	0.453 (11,5)	N/A	750
	H1	0.228 (5,8)	0.945 (24,0)	0.961 (24,4)	0.409 (10,4)	0.453 (11,5)	N/A	700
SDA03	H0	0.189 (4,8)	0.945 (24,0)	0.961 (24,4)	0.508 (12,9)	0.453 (11,5)	N/A	750
	H1	0.228 (5,8)	0.945 (24,0)	0.961 (24,4)	0.508 (12,9)	0.453 (11,5)	N/A	700
SDA04	H0	0.189 (4,8)	0.945 (24,0)	0.961 (24,4)	0.606 (15,4)	0.453 (11,5)	N/A	750
	H1	0.228 (5,8)	0.945 (24,0)	0.961 (24,4)	0.606 (15,4)	0.453 (11,5)	N/A	700
SDA05	H0	0.189 (4,8)	1.260 (32,0)	1.276 (32,4)	0.709 (18,0)	0.559 (14,2)	1.118 (28,4)	750
	H1	0.228 (5,8)	1.260 (32,0)	1.276 (32,4)	0.807 (20,5)	0.559 (14,2)	1.118 (28,4)	700
SDA06	H0	0.189 (4,8)	1.260 (32,0)	1.276 (32,4)	0.807 (20,5)	0.559 (14,2)	1.118 (28,4)	750
SDA07	H1	0.189 (4,8)	1.260 (32,0)	1.276 (32,4)	0.807 (20,5)	0.559 (14,2)	1.118 (28,4)	750
SDA08	H0	0.189 (4,8)	1.732 (44,0)	1.748 (44,4)	1.106 (28,1)	0.795 (20,2)	1.591 (40,4)	750
	H1	0.228 (5,8)	1.732 (44,0)	1.748 (44,4)	1.106 (28,1)	0.795 (20,2)	1.591 (40,4)	700
SDA09	H0	0.189 (4,8)	1.732 (44,0)	1.748 (44,4)	1.004 (25,5)	0.795 (20,2)	1.591 (40,4)	750
	H1	0.228 (5,8)	1.732 (44,0)	1.748 (44,4)	1.004 (25,5)	0.795 (20,2)	1.591 (40,4)	700
SDA10	H0	0.189 (4,8)	1.732 (44,0)	1.748 (44,4)	1.106 (28,1)	0.795 (20,2)	1.591 (40,4)	750
	H1	0.228 (5,8)	1.732 (44,0)	1.748 (44,4)	1.106 (28,1)	0.795 (20,2)	1.591 (40,4)	700
SDA12	H0	0.189 (4,8)	1.732 (44,0)	1.748 (44,4)	1.307 (33,2)	0.795 (20,2)	1.591 (40,4)	750
	H1	0.228 (5,8)	1.732 (44,0)	1.748 (44,4)	1.307 (33,2)	0.795 (20,2)	1.591 (40,4)	700

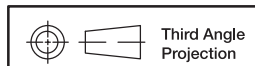

Dimensions are shown: Inch (mm)  
Specifications and dimensions subject to change