

PTS125 Series 12 mm Tact Switches



Features/Benefits

- Stable control feeling
- Thru-hole actuation
- 160 or 260 grams actuation force
- RoHS compliant and compatible

Typical Applications

- Consumer products
- Instrumentation
- Computer products
- Industrial

Specification

FUNCTION: Momentary action
CONTACT ARRANGEMENT: SPST, N.O.
TERMINALS: PC pins

Mechanical

ACTUATION FORCE: PTS125M models: 160 grams.
PTS125 K models: 260 grams.
LIFE EXPECTANCY: 200,000 operations, M option;
100,000 operations, K option.

Electrical

CONTACT RATING: 50 mA @ 12 V DC.0
DIELECTRIC STRENGTH: 250 V AC min.
CONTACT RESISTANCE: 100 mΩ max. initial.
INSULATION RESISTANCE: 10¹¹ Ω min.

NOTE: Specifications listed above are for switches with standard options.
For information on specific and custom switches, consult Customer Service Center.

Environmental

OPERATING TEMPERATURE: -40°C to 60°C

Process

SOLDERING: Preheating to 100°C for 45 sec. max. Keep flux flush with top surface of PCB; do not apply to component side of PCB and area where terminals are located. Soldering to 255°C for 5 sec. max. Clean by brushing on solder surface. Do not clean switch with solvents.

Materials

BASE: 6/6 nylon or glass filled polyester (PBT) (UL 94V-0).
ACTUATOR: PBT (UL94V0) or polyacetal (UL 94HB).
COVER PLATE: Tin alloy.
DOME CONTACTS: Phosphor bronze, silver clad.
STATIONARY CONTACTS: Brass, silver plated.
TERMINALS: Brass, silver plated. Insert molded.

Packaging

Tube packaging.

How To Order

Our easy build-a-switch concept allows you to mix and match options to create the switch you need. To order, select desired option from each category and place it in the appropriate box.

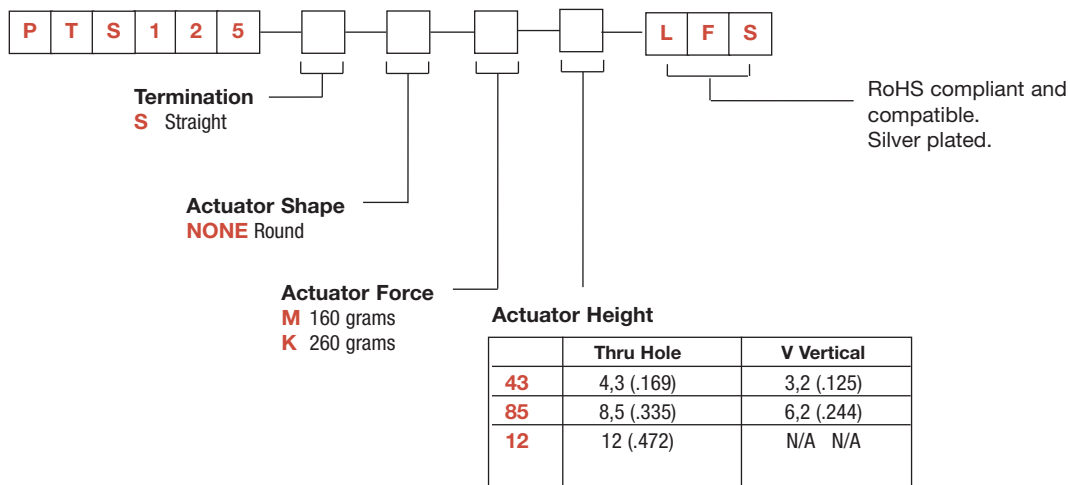

PTS125 Series 12 mm Tact Switches

SERIES 

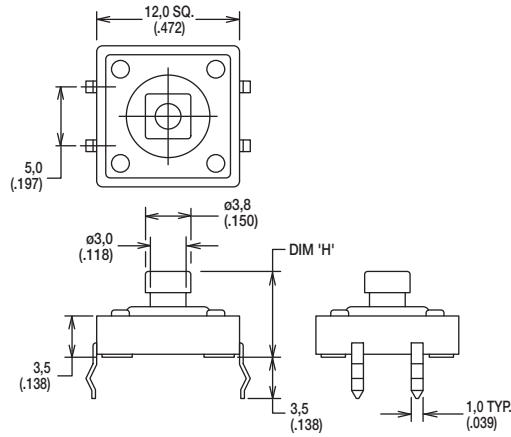

Tactile Switches

TERMINATION 

S STRAIGHT

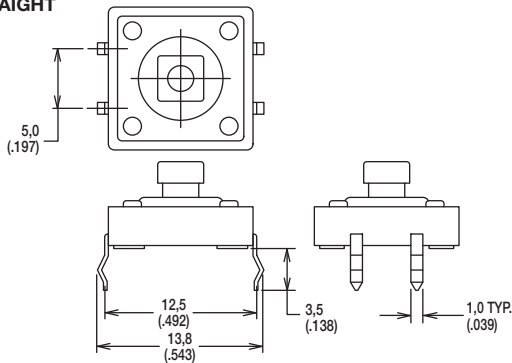

PCB LAYOUT

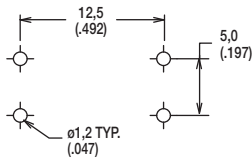

ACTUATOR SHAPE 

NONE ROUND

43 and 85 heights only

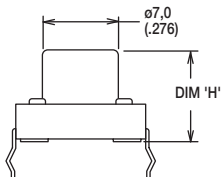
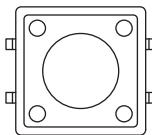

12 height only

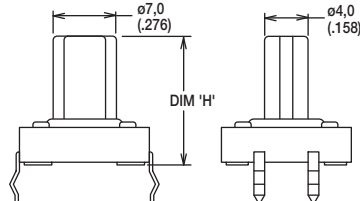
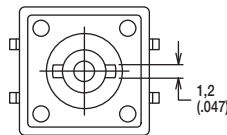

First Angle
Projection

Dimensions are shown: mm (inches)
Specifications and dimensions subject to change



PTS125 Series 12 mm Tact Switches

ACTUATION FORCE



OPTION CODE	FORCE
M	160 grams
K	260 grams

B

Tactile Switches

ACTUATOR HEIGHT



43 4,3 mm

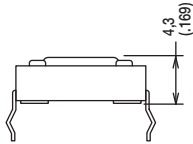

85 8,5 mm

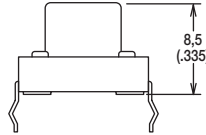

12 12 mm

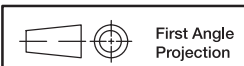
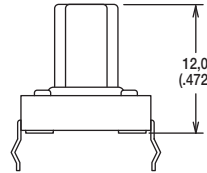

First Angle
Projection

Dimensions are shown: mm (inches)
Specifications and dimensions subject to change

