

# SUBMINIATURE DB Series

## Features

- High-precision switch with high repeat accuracy
- Models available for operating temperatures up to 120°C
- Rated for currents up to 10 amp at 250VAC
- Range of auxiliary actuators available (can also be retrofitted); two mounting positions
- Variety of contact materials available to suit your application
- Mechanical life: up to  $15 \times 10^6$  operations
- Wide variety of terminal types available
- Numerous approvals

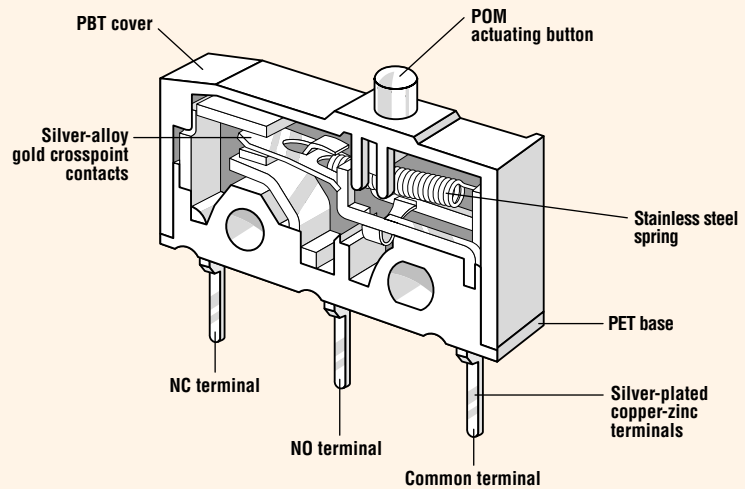

## Electrical Ratings

Switch Series	EN61058 Rating	UL1054 Rating	Electrical Life at Rated Load	
			According to EN (Min. Operations)	According to UL (Min. Operations)
DB1	6A, 250V~	5A, 125/250VAC	10,000	6,000
DB2	10(1.5)A, 250V~	10.1A, 125/250VAC; 1/4HP, 125VAC	10,000	6,000
DB3	0.1A, 250V~	0.1A, 125/250VAC	50,000	6,000
DB5*	1A, 250V~	1A, 125/250VAC	50,000	6,000
DB6*	6A, 250V~	5A, 125/250VAC	50,000	6,000
DB7*	10(1.5A), 400V~	10.1A, 125/250VAC; 1/4HP, 125VAC	50,000	6,000

\*85°C

## Specifications

### Electrical

Temperature Rating: -40°C to +85°C / +120°C

Flammability Rating: UL94V-O (PBT, PET)  
UL94HB (POM)

### Materials

Base: PET

Cover: PBT

Actuator: PBT, POM

Auxiliary Actuator: Stainless Steel or Plastic

Terminals: Silver-Plated Copper-Zinc















Contacts: Silver Alloy  
Gold Crosspoint

PBT = Polybutyleneterephthalate • PET = Polyethyleneterephthalate • POM = Polyacetal





## Actuator Specifications — Standard Ratio

Actuator Code	Switch Type	Maximum Operating Force (gms.)	Maximum Pre-Travel inches (mm)	Operating Point inches (mm)	Minimum Over-Travel inches (mm)	Max. Movement Differential inches (mm)	Max. Rest Position inches (mm)	Actuation Length inches (mm)	
AA		DB5	70	0.039 (1.0)	0.331±0.012 (8.4±0.3)	0.024 (0.6)	0.004 (0.10)	0.366 (9.3)	—
		DB1/3	150	0.039 (1.0)	0.331±0.012 (8.4±0.3)	0.024 (0.6)	0.004 (0.10)	0.366 (9.3)	—
		DB6	150	0.039 (1.0)	0.331±0.012 (8.4±0.3)	0.024 (0.6)	0.006 (0.15)	0.366 (9.3)	—
		DB2	250	0.039 (1.0)	0.331±0.012 (8.4±0.3)	0.024 (0.6)	0.004 (0.10)	0.366 (9.3)	—
		DB7	280	0.039 (1.0)	0.331±0.012 (8.4±0.3)	0.024 (0.6)	0.006 (0.15)	0.366 (9.3)	—
BA		DB5	70	0.039 (1.0)	0.331±0.012 (8.4±0.3)	0.024 (0.6)	0.004 (0.10)	0.366 (9.3)	—
		DB1/3	150	0.039 (1.0)	0.331±0.012 (8.4±0.3)	0.024 (0.6)	0.004 (0.10)	0.366 (9.3)	—
		DB6	250	0.039 (1.0)	0.331±0.012 (8.4±0.3)	0.024 (0.6)	0.006 (0.15)	0.366 (9.3)	—
		DB2	250	0.039 (1.0)	0.331±0.012 (8.4±0.3)	0.024 (0.6)	0.004 (0.10)	0.366 (9.3)	—
		DB7	280	0.039 (1.0)	0.331±0.012 (8.4±0.3)	0.024 (0.6)	0.006 (0.15)	0.366 (9.3)	—
<i>Auxiliary actuator, rear-mounted (RM)</i>									
LB		DB5	30	0.157 (4.0)	0.421±0.051 (10.7±1.3)	0.079 (2.0)	0.020 (0.5)	0.551 (14.0)	0.189 (4.8)
		DB1/3	60	0.157 (4.0)	0.421±0.051 (10.7±1.3)	0.079 (2.0)	0.020 (0.5)	0.551 (14.0)	0.189 (4.8)
		DB6	60	0.157 (4.0)	0.421±0.051 (10.7±1.3)	0.079 (2.0)	0.030 (0.75)	0.551 (14.0)	0.189 (4.8)
		DB2	100	0.177 (4.5)	0.421±0.063 (10.7±1.6)	0.059 (1.5)	0.028 (0.70)	0.551 (14.0)	0.189 (4.8)
		DB7	115	0.177 (4.5)	0.421±0.063 (10.7±1.6)	0.059 (1.5)	0.030 (0.75)	0.551 (14.0)	0.189 (4.8)
LC		DB5	25	0.177 (4.5)	0.437±0.059 (11.1±1.5)	0.079 (2.0)	0.024 (0.6)	0.591 (15.0)	0.276 (7.0)
		DB1/3	50	0.177 (4.5)	0.437±0.059 (11.1±1.5)	0.079 (2.0)	0.024 (0.6)	0.591 (15.0)	0.276 (7.0)
		DB6	50	0.177 (4.5)	0.437±0.059 (11.1±1.5)	0.079 (2.0)	0.047 (1.2)	0.591 (15.0)	0.276 (7.0)
		DB2	85	0.197 (5.0)	0.437±0.071 (11.1±1.8)	0.059 (1.5)	0.039 (1.0)	0.591 (15.0)	0.276 (7.0)
		DB7	100	0.197 (5.0)	0.437±0.071 (11.1±1.8)	0.059 (1.5)	0.047 (1.2)	0.591 (15.0)	0.276 (7.0)
LD		DB5	9	0.591 (15.0)	0.512±0.138 (13.0±3.5)	0.157 (4.0)	0.177 (4.5)	1.063 (27.0)	1.654 (42.0)
		DB1/3	18	0.591 (15.0)	0.512±0.138 (13.0±3.5)	0.157 (4.0)	0.177 (4.5)	1.063 (27.0)	1.654 (42.0)
		DB6	18	0.591 (15.0)	0.512±0.138 (13.0±3.5)	0.157 (4.0)	0.268 (6.8)	1.063 (27.0)	1.654 (42.0)
		DB2/7	—	—	—	—	—	—	on request
SB		DB5	30	0.157 (4.0)	0.630±0.051 (16.0±1.3)	0.079 (2.0)	0.020 (0.5)	0.748 (19.0)	0.098 (2.5)
		DB1/3	65	0.157 (4.0)	0.630±0.051 (16.0±1.3)	0.079 (2.0)	0.020 (0.5)	0.748 (19.0)	0.098 (2.5)
		DB6	65	0.157 (4.0)	0.630±0.051 (16.0±1.3)	0.079 (2.0)	0.043 (1.1)	0.748 (19.0)	0.098 (2.5)
		DB2	110	0.177 (4.5)	0.630±0.063 (16.0±1.6)	0.059 (1.5)	0.028 (0.7)	0.748 (19.0)	0.098 (2.5)
		DB7	125	0.177 (4.5)	0.630±0.063 (16.0±1.6)	0.059 (1.5)	0.043 (1.1)	0.748 (19.0)	0.098 (2.5)
SC		DB5	25	0.177 (4.5)	0.646±0.059 (16.4±1.5)	0.079 (2.0)	0.024 (0.6)	0.787 (20.0)	0.185 (4.7)
		DB1/3	55	0.177 (4.5)	0.646±0.059 (16.4±1.5)	0.079 (2.0)	0.024 (0.6)	0.787 (20.0)	0.185 (4.7)
		DB6	55	0.177 (4.5)	0.646±0.059 (16.4±1.5)	0.079 (2.0)	0.047 (1.2)	0.787 (20.0)	0.185 (4.7)
		DB2	95	0.197 (5.0)	0.646±0.071 (16.4±1.8)	0.059 (1.5)	0.039 (1.0)	0.787 (20.0)	0.185 (4.7)
		DB7	110	0.197 (5.0)	0.646±0.071 (16.4±1.8)	0.059 (1.5)	0.047 (1.2)	0.787 (20.0)	0.185 (4.7)
SD		DB5	9	0.591 (15.0)	0.720±0.138 (18.3±3.5)	0.157 (4.0)	0.177 (4.5)	1.260 (32.0)	1.563 (39.7)
		DB1/3	20	0.591 (15.0)	0.720±0.138 (18.3±3.5)	0.157 (4.0)	0.177 (4.5)	1.260 (32.0)	1.563 (39.7)
		DB6	20	0.591 (15.0)	0.720±0.138 (18.3±3.5)	0.157 (4.0)	0.268 (6.8)	1.260 (32.0)	1.563 (39.7)
		DB2/7	—	—	—	—	—	—	on request
RB		DB5	30	0.157 (4.0)	0.622±0.051 (15.8±1.3)	0.079 (2.0)	0.020 (0.5)	0.748 (19.0)	0.098 (2.5)
		DB1/3	65	0.157 (4.0)	0.622±0.051 (15.8±1.3)	0.079 (2.0)	0.020 (0.5)	0.748 (19.0)	0.098 (2.5)
		DB6	65	0.157 (4.0)	0.622±0.051 (15.8±1.3)	0.079 (2.0)	0.030 (0.75)	0.748 (19.0)	0.098 (2.5)
		DB2	110	0.177 (4.5)	0.622±0.063 (15.8±1.6)	0.059 (1.5)	0.028 (0.7)	0.748 (19.0)	0.098 (2.5)
		DB7	125	0.177 (4.5)	0.622±0.063 (15.8±1.6)	0.059 (1.5)	0.030 (0.75)	0.748 (19.0)	0.098 (2.5)
RC		DB5	25	0.177 (4.5)	0.638±0.059 (16.2±1.5)	0.079 (2.0)	0.024 (0.6)	0.787 (20.0)	0.185 (4.7)
		DB1/3	55	0.177 (4.5)	0.638±0.059 (16.2±1.5)	0.079 (2.0)	0.024 (0.6)	0.787 (20.0)	0.185 (4.7)
		DB6	55	0.177 (4.5)	0.638±0.059 (16.2±1.5)	0.079 (2.0)	0.047 (1.2)	0.787 (20.0)	0.185 (4.7)
		DB2	95	0.197 (5.0)	0.638±0.071 (16.2±1.8)	0.059 (1.5)	0.039 (1.0)	0.787 (20.0)	0.185 (4.7)
		DB7	110	0.197 (5.0)	0.638±0.071 (16.2±1.8)	0.059 (1.5)	0.047 (1.2)	0.787 (20.0)	0.185 (4.7)
RD		DB5	9	0.591 (15.0)	0.713±0.138 (18.1±3.5)	0.157 (4.0)	0.177 (4.5)	1.260 (32.0)	1.563 (39.7)
		DB1/3	20	0.591 (15.0)	0.713±0.138 (18.1±3.5)	0.157 (4.0)	0.177 (4.5)	1.260 (32.0)	1.563 (39.7)
		DB6	20	0.591 (15.0)	0.713±0.138 (18.1±3.5)	0.157 (4.0)	0.268 (6.8)	1.260 (32.0)	1.563 (39.7)
		DB2/7	—	—	—	—	—	—	on request
WB*		DB5	24	0.177 (4.5)	0.437±0.059 (11.1±1.5)	0.079 (2.0)	0.024 (0.6)	0.591 (15.0)	0.276 (7.0)
		DB1/3	50	0.177 (4.5)	0.437±0.059 (11.1±1.5)	0.079 (2.0)	0.024 (0.6)	0.591 (15.0)	0.276 (7.0)
		DB6	50	0.177 (4.5)	0.437±0.059 (11.1±1.5)	0.079 (2.0)	0.035 (0.9)	0.591 (15.0)	0.276 (7.0)
		DB2	85	0.177 (4.5)	0.437±0.059 (11.1±1.5)	0.079 (2.0)	0.024 (0.6)	0.591 (15.0)	0.276 (7.0)
		DB7	100	0.177 (4.5)	0.437±0.059 (11.1±1.5)	0.079 (2.0)	0.035 (0.9)	0.591 (15.0)	0.276 (7.0)
WC*		DB5	18	0.236 (6.0)	0.480±0.071 (12.2±1.8)	0.118 (3.0)	0.031 (0.8)	0.669 (17.0)	0.551 (14.0)
		DB1/3	38	0.236 (6.0)	0.480±0.071 (12.2±1.8)	0.118 (3.0)	0.031 (0.8)	0.669 (17.0)	0.551 (14.0)
		DB6	38	0.236 (6.0)	0.480±0.071 (12.2±1.8)	0.118 (3.0)	0.047 (1.2)	0.669 (17.0)	0.551 (14.0)
		DB2	63	0.236 (6.0)	0.480±0.071 (12.2±1.8)	0.118 (3.0)	0.031 (0.8)	0.669 (17.0)	0.551 (14.0)
		DB7	75	0.236 (6.0)	0.480±0.071 (12.2±1.8)	0.118 (3.0)	0.047 (1.2)	0.669 (17.0)	0.551 (14.0)
VB*		DB5	25	0.177 (4.5)	0.469±0.055 (11.9±1.4)	0.079 (2.0)	0.024 (0.6)	0.591 (15.0)	0.220 (5.6)
		DB1/3	55	0.177 (4.5)	0.469±0.055 (11.9±1.4)	0.079 (2.0)	0.024 (0.6)	0.591 (15.0)	0.220 (5.6)
		DB6	55	0.177 (4.5)	0.469±0.055 (11.9±1.4)	0.079 (2.0)	0.035 (0.9)	0.591 (15.0)	0.220 (5.6)
		DB2	90	0.177 (4.5)	0.469±0.055 (11.9±1.4)	0.079 (2.0)	0.024 (0.6)	0.591 (15.0)	0.220 (5.6)
		DB7	105	0.177 (4.5)	0.469±0.055 (11.9±1.4)	0.079 (2.0)	0.035 (0.9)	0.591 (15.0)	0.220 (5.6)
ZB*		DB5	25	0.177 (4.5)	0.630±0.055 (16.0±1.4)	0.059 (1.5)	0.024 (0.6)	0.748 (19.0)	0.205 (5.2)
		DB1/3	55	0.177 (4.5)	0.630±0.055 (16.0±1.4)	0.059 (1.5)	0.024 (0.6)	0.748 (19.0)	0.205 (5.2)
		DB6	55	0.177 (4.5)	0.630±0.055 (16.0±1.4)	0.059 (1.5)	0.035 (0.9)	0.748 (19.0)	0.205 (5.2)
		DB2	90	0.177 (4.5)	0.630±0.055 (16.0±1.4)	0.059 (1.5)	0.024 (0.6)	0.748 (19.0)	0.205 (5.2)
		DB7	105	0.177 (4.5)	0.630±0.055 (16.0±1.4)	0.059 (1.5)	0.035 (0.9)	0.748 (19.0)	0.205 (5.2)

\*For 85°C only

