

2N4427
SILICON
NPN RF TRANSISTOR



TO-39 CASE

DESCRIPTION:

The CENTRAL SEMICONDUCTOR 2N4427 is a silicon NPN epitaxial planar RF transistor mounted in a hermetically sealed package designed for high frequency amplifier applications.

MARKING: FULL PART NUMBER

MAXIMUM RATINGS: ($T_A=25^\circ\text{C}$ unless otherwise noted)

	SYMBOL		UNITS
Collector-Base Voltage	V_{CBO}	40	V
Collector-Emitter Voltage	V_{CEO}	20	V
Emitter-Base Voltage	V_{EBO}	2.0	V
Continuous Collector Current	I_C	400	mA
Continuous Base Current	I_B	400	mA
Power Dissipation	P_D	1.0	W
Power Dissipation ($T_C=25^\circ\text{C}$)	P_D	3.5	W
Operating and Storage Junction Temperature	T_J, T_{stg}	-65 to +200	$^\circ\text{C}$

ELECTRICAL CHARACTERISTICS: ($T_A=25^\circ\text{C}$ unless otherwise noted)

SYMBOL	TEST CONDITIONS	MIN	MAX	UNITS
I_{CEV}	$V_{CE}=40\text{V}, V_{BE}=1.5\text{V}$		100	μA
I_{CEV}	$V_{CE}=12\text{V}, V_{BE}=1.5\text{V}, T_C=150^\circ\text{C}$		5.0	mA
I_{CEO}	$V_{CE}=12\text{V}$		20	μA
I_{EBO}	$V_{EB}=2.0\text{V}$		100	μA
BV_{CER}	$I_C=5.0\text{mA}, R_{BE}=10\Omega$	40		V
BV_{CEO}	$I_C=5.0\text{mA}$	20		V
$V_{CE(SAT)}$	$I_C=100\text{mA}, I_B=20\text{mA}$		0.5	V
h_{FE}	$V_{CE}=5.0\text{V}, I_C=100\text{mA}$	10	200	
h_{FE}	$V_{CE}=5.0\text{V}, I_C=360\text{mA}$	5.0		
f_T	$V_{CE}=15\text{V}, I_C=50\text{mA}, f=200\text{MHz}$	500		MHz
C_{ob}	$V_{CB}=12\text{V}, I_E=0, f=1.0\text{MHz}$		4.0	pF
G_{pe}	$V_{CC}=12\text{V}, P_{in}=100\text{mW}, f=175\text{MHz}$	10		dB
η	$V_{CC}=12\text{V}, P_{out}=1.0\text{W}, f=175\text{MHz}$	50		%
P_{in}	$V_{CC}=12\text{V}, P_{out}=1.0\text{W}, f=175\text{MHz}$		100	mW

2N4427
 SILICON
 NPN RF TRANSISTOR



TO-39 CASE - MECHANICAL OUTLINE

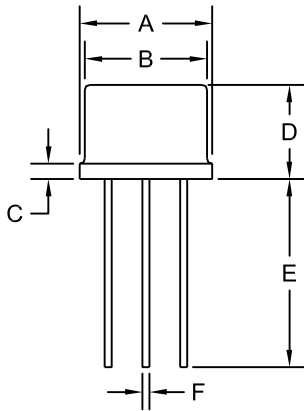

SYMBOL	DIMENSIONS			
	INCHES		MILLIMETERS	
	MIN	MAX	MIN	MAX
A (DIA)	0.335	0.370	8.51	9.40
B (DIA)	0.315	0.335	8.00	8.51
C	-	0.040	-	1.02
D	0.240	0.260	6.10	6.60
E	0.500	-	12.70	-
F (DIA)	0.016	0.021	0.41	0.53
G (DIA)	0.200		5.08	
H	0.100		2.54	
I	0.028	0.034	0.71	0.86
J	0.029	0.045	0.74	1.14

TO-39 (REV: R1)

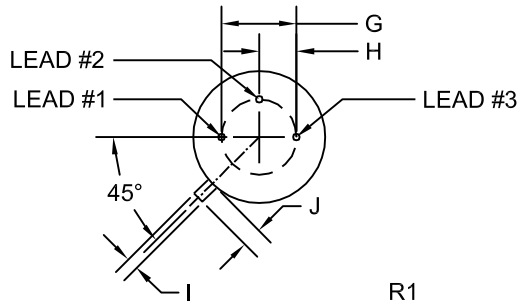

LEAD CODE:

- 1) Emitter
- 2) Base
- 3) Collector

MARKING: FULL PART NUMBER

R1 (4-June 2013)

2N4427
SILICON
NPN RF TRANSISTOR



TYPICAL ELECTRICAL CHARACTERISTICS

DC Current Gain

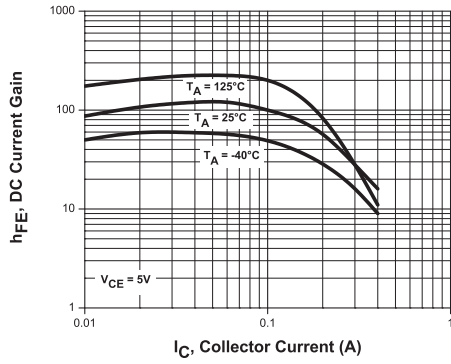

"ON" Voltage

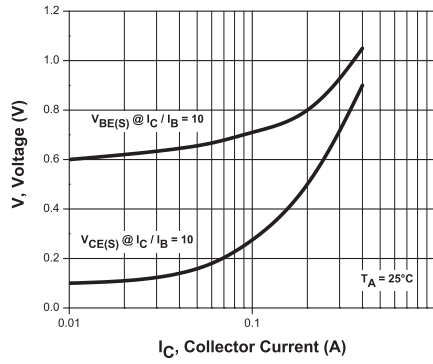

Capacitance

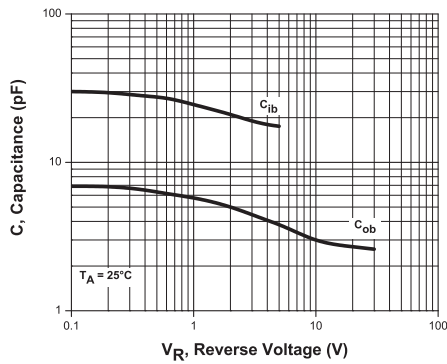

Safe Operating Area

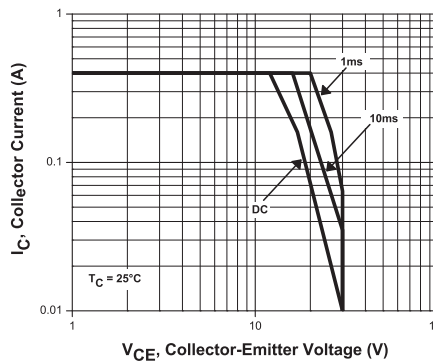

Power Derating

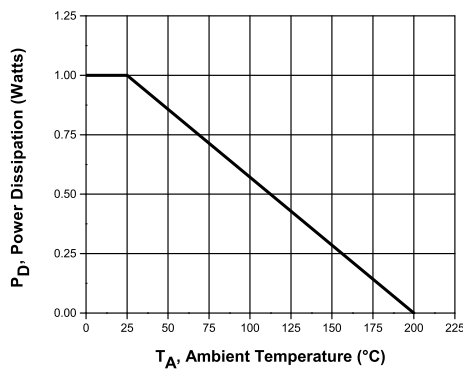

Current Gain-Bandwidth Product

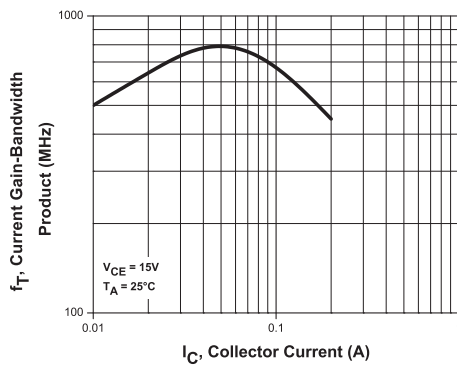

R1 (4-June 2013)

OUTSTANDING SUPPORT AND SUPERIOR SERVICES



PRODUCT SUPPORT

Central's operations team provides the highest level of support to insure product is delivered on-time.

- Supply management (Customer portals)
- Inventory bonding
- Consolidated shipping options
- Custom bar coding for shipments
- Custom product packing

DESIGNER SUPPORT/SERVICES

Central's applications engineering team is ready to discuss your design challenges. Just ask.

- Free quick ship samples (2nd day air)
- Online technical data and parametric search
- SPICE models
- Custom electrical curves
- Environmental regulation compliance
- Customer specific screening
- Up-screening capabilities
- Special wafer diffusions
- PbSn plating options
- Package details
- Application notes
- Application and design sample kits
- Custom product and package development

REQUESTING PRODUCT PLATING

1. If requesting Tin/Lead plated devices, add the suffix " TIN/LEAD" to the part number when ordering (example: 2N2222A TIN/LEAD).
2. If requesting Lead (Pb) Free plated devices, add the suffix " PBFREE" to the part number when ordering (example: 2N2222A PBFREE).

CONTACT US

Corporate Headquarters & Customer Support Team

Central Semiconductor Corp.
145 Adams Avenue
Hauppauge, NY 11788 USA
Main Tel: (631) 435-1110
Main Fax: (631) 435-1824
Support Team Fax: (631) 435-3388
www.centrasemi.com

Worldwide Field Representatives:
www.centrasemi.com/wwreps

Worldwide Distributors:
www.centrasemi.com/wwdistributors

For the latest version of Central Semiconductor's **LIMITATIONS AND DAMAGES DISCLAIMER**, which is part of Central's Standard Terms and Conditions of sale, visit: www.centrasemi.com/terms



<http://www.centrasemi.com>

Product End of Life Notification

PDN ID:	PDN01114
Notification Date:	9/06/19
Last Buy Date:	Stock Only
Last Shipment Date	Stock Only

Please be advised that Central Semiconductor must immediately discontinue the product(s) listed in the attached PDN notice. We are unable to accept any further orders for these products **unless** we have available inventory on hand.

You may have purchased one or more of the products listed. Please do not hesitate to contact your local Central Semiconductor sales representative with any questions or needs you may have. Central regrets any inconvenience this may cause.

Sincerely,

Central Semiconductor Corp.

DISCLAIMER: This End of Life (EOL) notification is in accordance with JEDEC standard JESD48 - Product Discontinuance. Central Semiconductor Corp. will make every effort to offer life-time buy (LTB) opportunities and/or offer replacement devices to existing customers for discontinued devices, however, one or both may not be possible for all devices. Please contact your local Central Semiconductor sales representative for LTB opportunities/additional information.

Product End of Life Notification

PDN ID:	PDN01114
Notification Date:	9/06/19
Last Buy Date:	Stock Only
Last Shipment Date	Stock Only

Summary: The CP616, CP617, CP618, CP223, CP229 and CP243 RF transistor die processes are discontinued and now classified and End of Life (EOL).

Although Central Semiconductor Corp. makes every effort to continue to produce devices that have been proclaimed EOL (End of Life) by other manufacturers, it is an accepted industry practice to discontinue certain devices when customer demand falls below a minimum level of sustainability. Accordingly, the following product(s) have been transitioned to End of Life status as part of Central's ongoing Product Management Process. Any replacement products are noted below. The effective date for placing last purchase orders will be six (6) months from the date of this notice and twelve (12) months from the notice date for final shipments, and minimum order quantities may apply. The last purchase and shipment dates may be extended if inventory is available.

<u>Central Part Number</u>	<u>Replacement</u>
BFW16A	N/A, Stock Only
CEN1179	N/A, Stock Only
CEN5503	N/A, Stock Only
CM4957	N/A, Stock Only
CM5160	N/A, Stock Only
CM5583	N/A, Stock Only
CM5943	N/A, Stock Only
CP223-2N3866-CT	N/A, Stock Only
CP223-2N3866-WN	N/A, Stock Only
CP229-2N5109-CM	N/A, Stock Only
CP229-2N5109-CT	N/A, Stock Only
CP229-2N5109-CT20	N/A, Stock Only
CP229-2N5109-WN	N/A, Stock Only
CP243-CM5943-WN	N/A, Stock Only
CP616-CM5160-CT	N/A, Stock Only
CP616-CM5160-CT20	N/A, Stock Only
CP616-CM5160-WN	N/A, Stock Only
CP616-2N5160-CM	N/A, Stock Only
CP616-2N5160-CT	N/A, Stock Only
CP616-2N5160-WN	N/A, Stock Only
CP617-CEN1271-CM	N/A, Stock Only
CP617-CEN1271-CT	N/A, Stock Only
CP617-CEN1271-WN	N/A, Stock Only
CP617-CM4957-CM	N/A, Stock Only
CP617-CM4957-CT	N/A, Stock Only
CP617-CM4957-CT20	N/A, Stock Only
CP617-CM4957-WN	N/A, Stock Only
CP618-CM5583-CT	N/A, Stock Only
CP618-CM5583-WN	N/A, Stock Only
CP618-2N5583-WN	N/A, Stock Only
2N3866	N/A, Stock Only
2N3866 TRAY	N/A, Stock Only
2N3866A	N/A, Stock Only
2N4427	N/A, Stock Only
2N5109	N/A, Stock Only
2N5109UB BK	N/A, Stock Only

*** CONTINUED ***

DISCLAIMER: This End of Life (EOL) notification is in accordance with JEDEC standard JESD48 - Product Discontinuance. Central Semiconductor Corp. will make every effort to offer life-time buy (LTB) opportunities and/or offer replacement devices to existing customers for discontinued devices, however, one or both may not be possible for all devices. Please contact your local Central Semiconductor sales representative for LTB opportunities/additional information.



<http://www.centrasemi.com>

Product End of Life Notification

PDN ID:	PDN01114
Notification Date:	9/06/19
Last Buy Date:	Stock Only
Last Shipment Date	Stock Only

Please be advised that Central Semiconductor must immediately discontinue the product(s) listed in the attached PDN notice. We are unable to accept any further orders for these products **unless** we have available inventory on hand.

You may have purchased one or more of the products listed. Please do not hesitate to contact your local Central Semiconductor sales representative with any questions or needs you may have. Central regrets any inconvenience this may cause.

Sincerely,

Central Semiconductor Corp.

DISCLAIMER: This End of Life (EOL) notification is in accordance with JEDEC standard JESD48 - Product Discontinuance. Central Semiconductor Corp. will make every effort to offer life-time buy (LTB) opportunities and/or offer replacement devices to existing customers for discontinued devices, however, one or both may not be possible for all devices. Please contact your local Central Semiconductor sales representative for LTB opportunities/additional information.



<http://www.centrasemi.com>

Product End of Life Notification

PDN ID:	PDN01114
Notification Date:	9/06/19
Last Buy Date:	Stock Only
Last Shipment Date	Stock Only

*** CONTINUED FROM PRIOR PAGE ***

<u>Central Part Number</u>	<u>Replacement</u>
----------------------------	--------------------

Central would be happy to assist you by providing additional information or technical data to help locate an alternate source if we have no replacement available. Please email your requests to engineering@centrasemi.com.

DISCLAIMER: This End of Life (EOL) notification is in accordance with JEDEC standard JESD48 - Product Discontinuance. Central Semiconductor Corp. will make every effort to offer life-time buy (LTB) opportunities and/or offer replacement devices to existing customers for discontinued devices, however, one or both may not be possible for all devices. Please contact your local Central Semiconductor sales representative for LTB opportunities/additional information.