



GaAs HBT INTEGRATED CIRCUIT

μ PG2314T5N

POWER AMPLIFIER FOR Bluetooth™ Class 1

DESCRIPTION

The μ PG2314T5N is GaAs HBT MMIC for power amplifier which was developed for Bluetooth Class 1.

This device realizes high efficiency, high gain and high output power by using InGaP HBT. This device is housed in a 6-pin plastic TSON (Thin Small Out-line Non-leaded) package. And this package is able to high-density surface mounting.

FEATURES

- Operation frequency : $f_{opt} = 2\ 400$ to $2\ 500$ MHz (2 450 MHz TYP.)
- Supply voltage : $V_{cc1, 2} = 2.7$ to 3.6 V (3.0 V TYP.)
- Control voltage : $V_{cont} = 0$ to 3.6 V (3.0 V TYP.)
: $V_{bias} + V_{enable} = 0$ to 3.1 V (3.0 V TYP.)
- Circuit current : $I_{cc} = 65$ mA TYP. @ $V_{cc1, 2} = 3.0$ V, $V_{bias} + V_{enable} = 3.0$ V, $V_{cont} = 3.0$ V,
 $P_{in} = 0$ dBm
- Output power : $P_{out} = +20$ dBm TYP. @ $V_{cc1, 2} = 3.0$ V, $V_{bias} + V_{enable} = 3.0$ V, $V_{cont} = 3.0$ V,
 $P_{in} = 0$ dBm
- Gain control range : GCR = 23 dB TYP. @ $V_{cc1, 2} = 3.0$ V, $V_{bias} + V_{enable} = 3.0$ V, $V_{cont} = 0$ to 3.0 V,
 $P_{in} = 0$ dBm
- High efficiency : PAE = 50% TYP.
- High-density surface mounting : 6-pin plastic TSON package ($1.5 \times 1.5 \times 0.37$ mm)

APPLICATIONS

- Power Amplifier for Bluetooth Class 1

ORDERING INFORMATION

Part Number	Order Number	Package	Marking	Supplying Form
μ PG2314T5N-E2	μ PG2314T5N-E2-A	6-pin plastic TSON (Pb-Free)	G5D	<ul style="list-style-type: none">• Embossed tape 8 mm wide• Pin 1, 6 face the perforation side of the tape• Qty 3 kpcs/reel

Remark To order evaluation samples, contact your nearby sales office.

Part number for sample order: μ PG2314T5N

Caution Observe precautions when handling because these devices are sensitive to electrostatic discharge.

The information in this document is subject to change without notice. Before using this document, please confirm that this is the latest version.

PIN CONNECTIONS AND INTERNAL BLOCK DIAGRAM

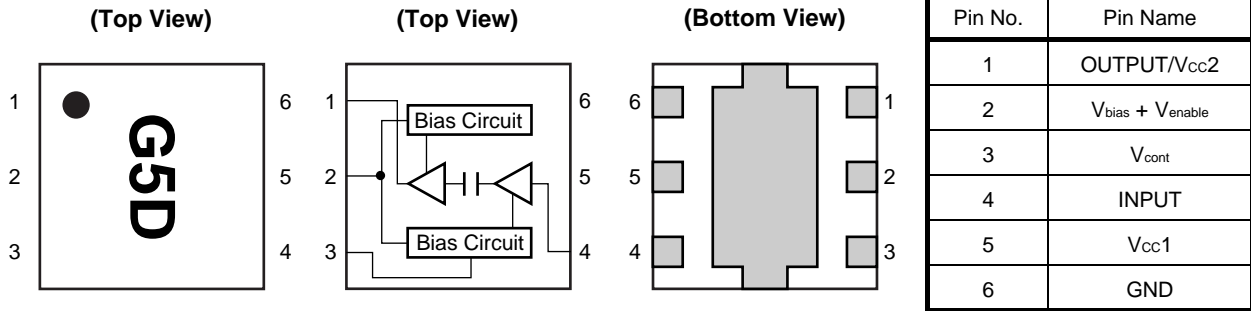

ABSOLUTE MAXIMUM RATINGS (T_A = +25°C, unless otherwise specified)

Parameter	Symbol	Ratings	Unit
Supply Voltage	V _{cc1, 2}	5.5	V
	V _{bias} + V _{enable}	3.6	V
Control Voltage	V _{cont}	3.6	V
Circuit Current	I _{cc}	400	mA
Control Current	I _{cont}	0.5	mA
Input Power	P _{in}	+10	dBm
Power Dissipation	P _D	700 ^{Note}	mW
Operating Ambient Temperature	T _A	-40 to +85	°C
Storage Temperature	T _{stg}	-55 to +150	°C

Note Mounted on double-sided copper-clad 50 × 50 × 1.6 mm epoxy glass PWB, T_A = +85°C

RECOMMENDED OPERATING RANGE (T_A = +25°C, unless otherwise specified)

Parameter	Symbol	MIN.	TYP.	MAX.	Unit
Operating Frequency	f _{opt}	2 400	2 450	2 500	MHz
Supply Voltage	V _{cc1, 2}	2.7	3.0	3.6	V
	V _{bias} + V _{enable}	0	3.0	3.1	V
Control Voltage	V _{cont}	0	3.0	3.6	V

ELECTRICAL CHARACTERISTICS

(T_A = +25°C, V_{CC1, 2} = V_{bias} + V_{enable} = 3.0 V, f = 2 450 MHz, P_{out} = +20 dBm, External input and output matching, unless otherwise specified)

Parameter	Symbol	Test Conditions	MIN.	TYP.	MAX.	Unit
Circuit Current	I _{CC}	V _{cont} = 3.0 V, P _{in} = 0 dBm	–	65	70	mA
Shut Down Current	I _{shut down}	V _{cont} = 3.0 V, P _{in} = 0 dBm , V _{bias} + V _{enable} = 0 V	–	0	1	μA
Output Power 1	P _{out1}	V _{cont} = 3.0 V, P _{in} = 0 dBm	+18.0	+20.0	–	dBm
Output Power 2	P _{out2}	V _{cont} = 0 V, P _{in} = 0 dBm	–	–3.0	+1.0	dBm
Gain Control Range	GCR	V _{cont} = 0 to 3.0 V, P _{in} = 0 dBm	17	23	–	dB
Efficiency	PAE	V _{cont} = 3.0 V, P _{in} = 0 dBm	–	50	–	%

EVALUATION CIRCUIT

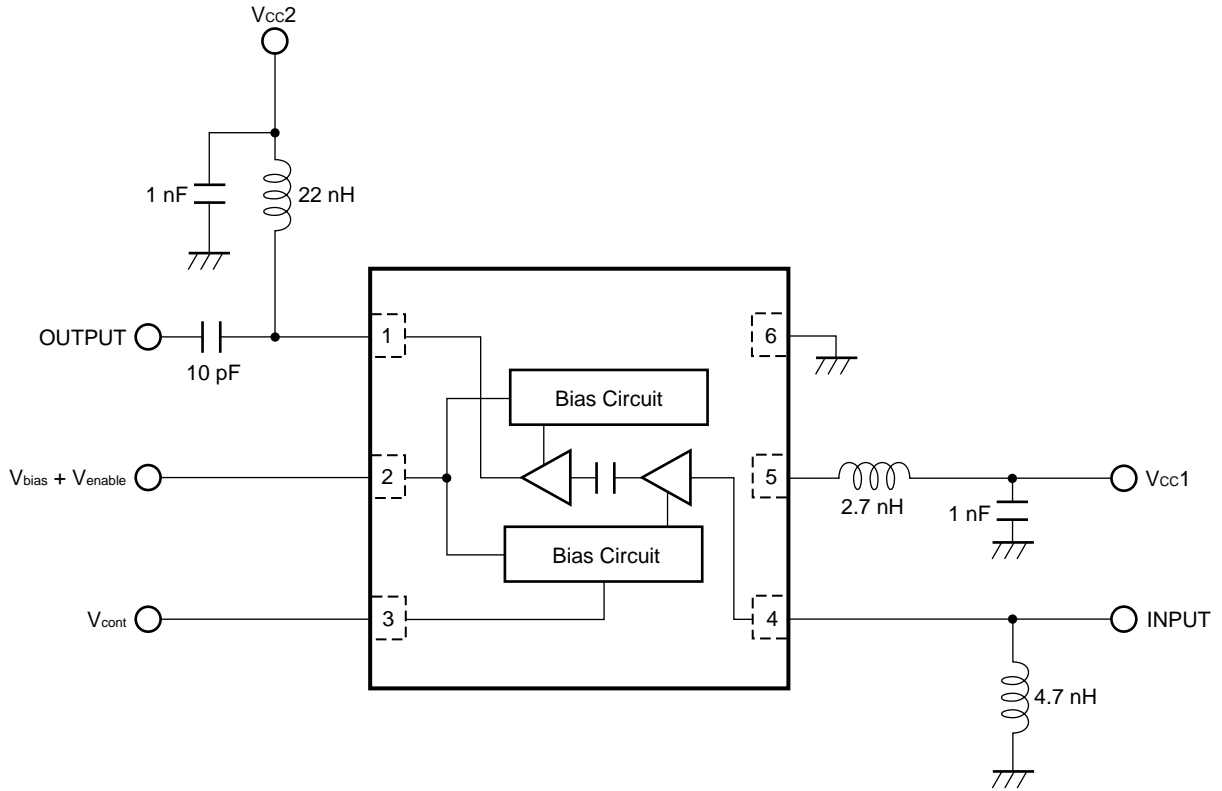

The application circuits and their parameters are for reference only and are not intended for use in actual design-ins.

TYPICAL CHARACTERISTICS (TA = +25°C, unless otherwise specified)

Condition : f = 2 450 MHz, Vcc1 = Vcc2 = Vbias + Venable = Vcont = 3.0 V, with external input and output matching circuit

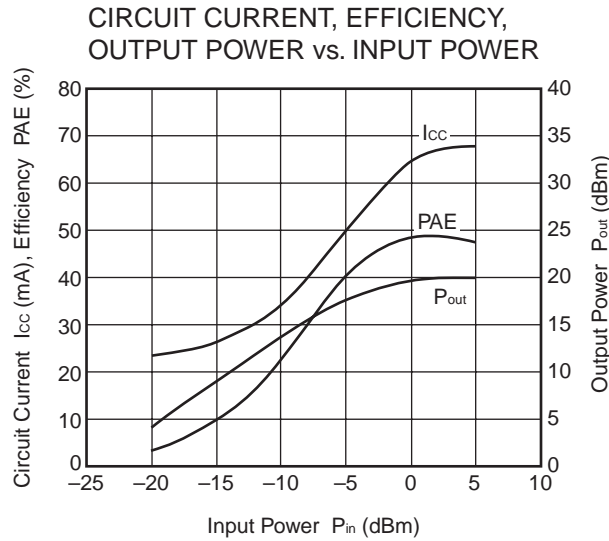

Condition : f = 2 450 MHz, Vcc1 = Vcc2 = Vbias + Venable = 3.0 V, P_{in} = 0 dBm, with external input and output matching circuit

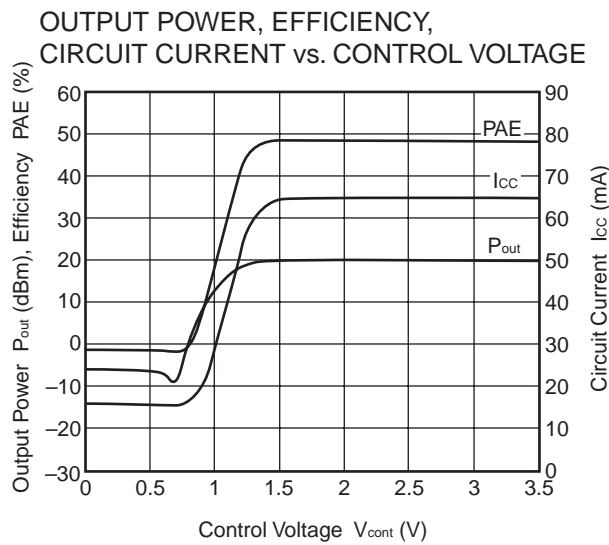

Remark The graphs indicate nominal characteristics.

Condition : $f = 2\,450\text{ MHz}$, $V_{cc1} = V_{cc2} = V_{cont} = 3.0\text{ V}$, $P_{in} = 0\text{ dBm}$, with external input and output matching circuit

OUTPUT POWER, $2f_0$, CIRCUIT CURRENT, EFFICIENCY vs. SUPPLY VOLTAGE

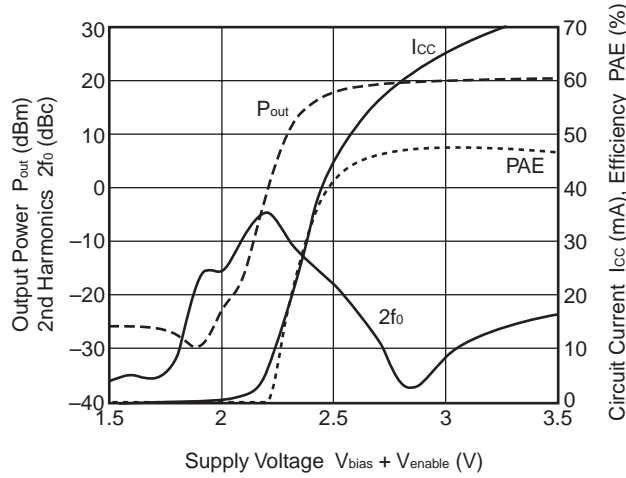

Condition : $V_{cc1} = V_{cc2} = V_{bias} + V_{enable} = V_{cont} = 3.0\text{ V}$, $P_{in} = -20\text{ dBm}$, with external input and output matching circuit

S11-FREQUENCY

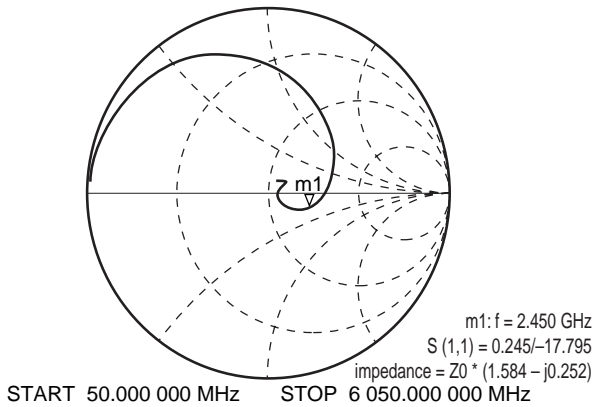

S11, S22-FREQUENCY

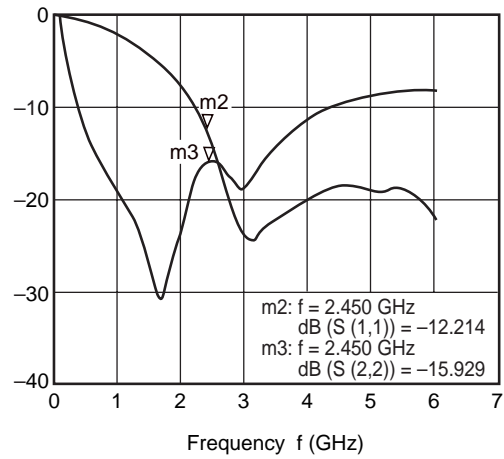

S21-FREQUENCY

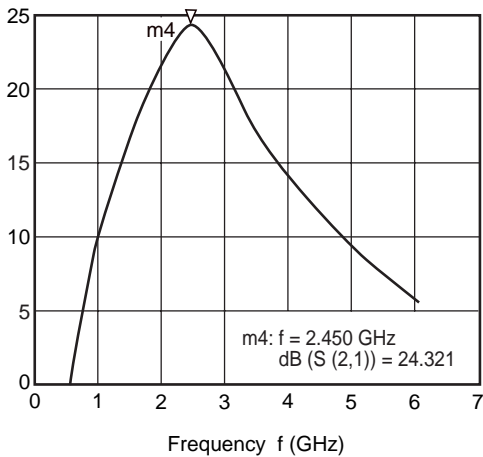

S22-FREQUENCY

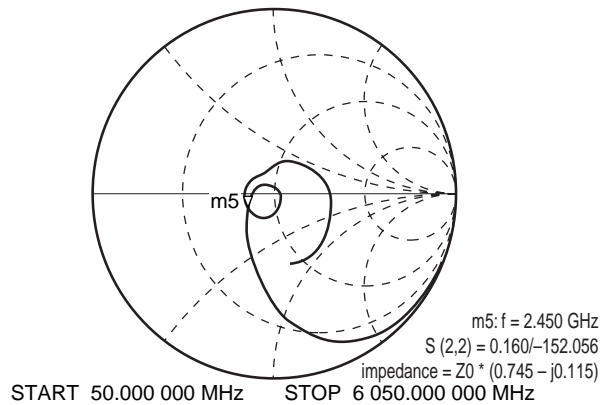

Remark The graphs indicate nominal characteristics.

MOUNTING PAD AND SOLDER MASK LAYOUT DIMENSIONS

6-PIN PLASTIC TSON (UNIT: mm)

MOUNTING PAD

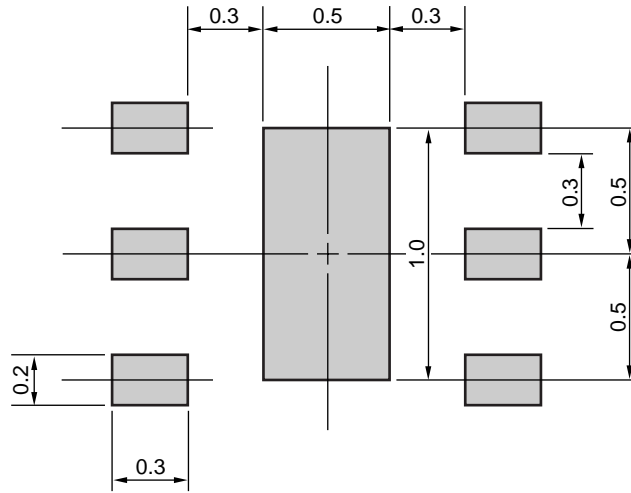

SOLDER PAD

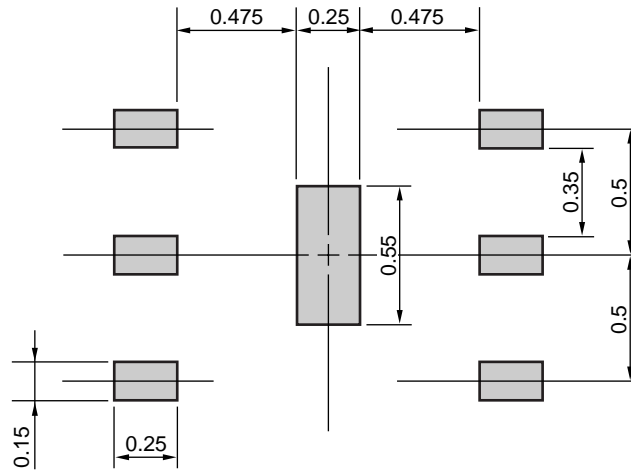

Solder thickness : 0.08 mm

Remark The mounting pad layouts in this document are for reference only.

PACKAGE DIMENSIONS

6-PIN PLASTIC TSON (UNIT: mm)

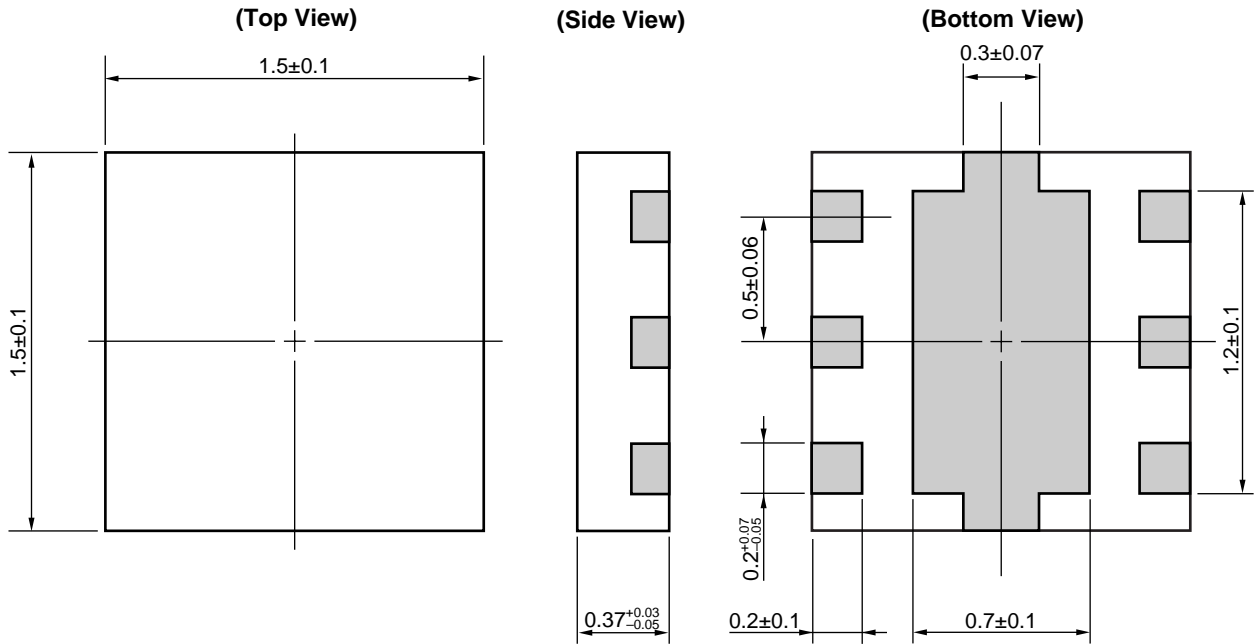

RECOMMENDED SOLDERING CONDITIONS

This product should be soldered and mounted under the following recommended conditions. For soldering methods and conditions other than those recommended below, contact your nearby sales office.

Soldering Method	Soldering Conditions	Condition Symbol
Infrared Reflow	Peak temperature (package surface temperature) : 260°C or below Time at peak temperature : 10 seconds or less Time at temperature of 220°C or higher : 60 seconds or less Preheating time at 120 to 180°C : 120±30 seconds Maximum number of reflow processes : 3 times Maximum chlorine content of rosin flux (% mass) : 0.2%(Wt.) or below	IR260
Wave Soldering	Peak temperature (molten solder temperature) : 260°C or below Time at peak temperature : 10 seconds or less Preheating temperature (package surface temperature) : 120°C or below Maximum number of flow processes : 1 time Maximum chlorine content of rosin flux (% mass) : 0.2%(Wt.) or below	WS260
Partial Heating	Peak temperature (terminal temperature) : 350°C or below Soldering time (per side of device) : 3 seconds or less Maximum chlorine content of rosin flux (% mass) : 0.2%(Wt.) or below	HS350

Caution Do not use different soldering methods together (except for partial heating).

Subject: Compliance with EU Directives

CEL certifies, to its knowledge, that semiconductor and laser products detailed below are compliant with the requirements of European Union (EU) Directive 2002/95/EC Restriction on Use of Hazardous Substances in electrical and electronic equipment (RoHS) and the requirements of EU Directive 2003/11/EC Restriction on Penta and Octa BDE.

CEL Pb-free products have the same base part number with a suffix added. The suffix –A indicates that the device is Pb-free. The –AZ suffix is used to designate devices containing Pb which are exempted from the requirement of RoHS directive (*). In all cases the devices have Pb-free terminals. All devices with these suffixes meet the requirements of the RoHS directive.

This status is based on CEL’s understanding of the EU Directives and knowledge of the materials that go into its products as of the date of disclosure of this information.

Restricted Substance per RoHS	Concentration Limit per RoHS (values are not yet fixed)	Concentration contained in CEL devices	
		-A	-AZ
Lead (Pb)	< 1000 PPM	Not Detected	(*)
Mercury	< 1000 PPM	Not Detected	
Cadmium	< 100 PPM	Not Detected	
Hexavalent Chromium	< 1000 PPM	Not Detected	
PBB	< 1000 PPM	Not Detected	
PBDE	< 1000 PPM	Not Detected	

If you should have any additional questions regarding our devices and compliance to environmental standards, please do not hesitate to contact your local representative.

Important Information and Disclaimer: Information provided by CEL on its website or in other communications concerning the substance content of its products represents knowledge and belief as of the date that it is provided. CEL bases its knowledge and belief on information provided by third parties and makes no representation or warranty as to the accuracy of such information. Efforts are underway to better integrate information from third parties. CEL has taken and continues to take reasonable steps to provide representative and accurate information but may not have conducted destructive testing or chemical analysis on incoming materials and chemicals. CEL and CEL suppliers consider certain information to be proprietary, and thus CAS numbers and other limited information may not be available for release.

In no event shall CEL’s liability arising out of such information exceed the total purchase price of the CEL part(s) at issue sold by CEL to customer on an annual basis.

See CEL Terms and Conditions for additional clarification of warranties and liability.