

5 V, SUPER MINIMOLD SILICON RFIC WIDEBAND AMPLIFIER

FEATURES

- **WIDE FREQUENCY RESPONSE:** 2.7 GHz
- **FLAT GAIN RESPONSE:** ± 1.0 dB
- **HIGH GAIN:** 23 dB
- **MEDIUM OUTPUT POWER:** P_{1dB} : 6.0 dBm at 1.0 GHz
- **5 V SINGLE SUPPLY VOLTAGE**
- **SMALL SURFACE MOUNT PACKAGE:** SOT-363
- **AVAILABLE ON TAPE AND REEL**

DESCRIPTION

The UPC2776TB is a Silicon Monolithic integrated circuit which is manufactured using the NESAT™ III process. This device is suitable for wide band IF blocks due to its high gain and flat response. The UPC2776TB is pin compatible and has comparable performance as the larger UPC2776T, so it is suitable for use as a replacement to help reduce system size. The IC is housed in a 6 pin super minimold or SOT-363 package. The UPC2776TB is designed as a low cost IC gain stage in DBS, TVRO, PCS, WLAN and other communication receivers.

GAIN vs. FREQUENCY

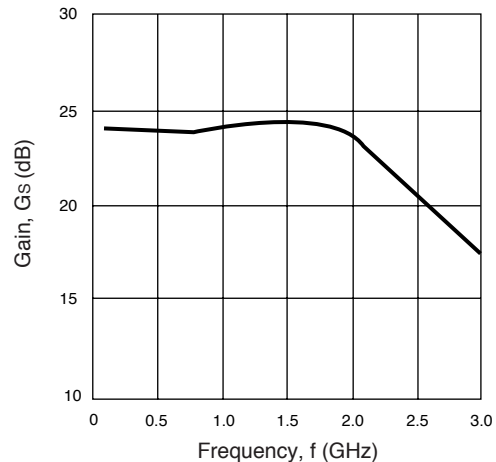

TEST CIRCUIT

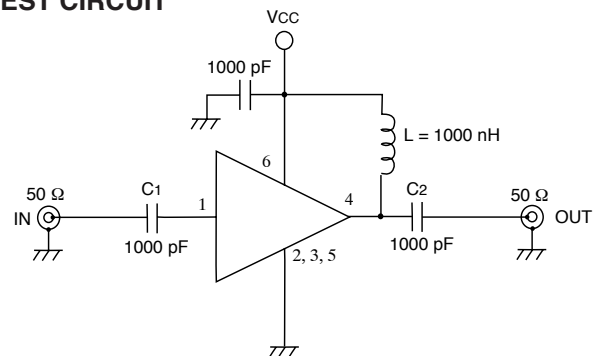

ELECTRICAL CHARACTERISTICS ($V_{CC} = 5.0$ V, $T_A = 25^\circ\text{C}$, $Z_L = Z_S = 50 \Omega$)

PART NUMBER PACKAGE OUTLINE		UPC2776TB S06			
SYMBOLS	PARAMETERS AND CONDITIONS	UNITS	MIN	TYP	MAX
I_{CC}	Circuit Current (no signal)	mA	18	25	33
G_s	Small Signal Gain, $f = 1$ GHz	dB	21	23	26
f_u	Upper Limit Operating Frequency (The gain at f_u is 3 dB down from the gain at 0.1 GHz)	GHz	2.3	2.7	
ΔG_s	Gain Flatness, $f = 0.1$ to 2.0 GHz	dB		± 1.0	
P_{1dB}	Output Power at 1 dB Compression, $f = 1$ GHz	dBm	+4	+6.0	
NF	Noise Figure, $f = 1$ GHz	dB		6.0	7.5
RL_{IN}	Input Return Loss, $f = 1$ GHz	dB	4.5	7.5	
RL_{OUT}	Output Return Loss, $f = 1$ GHz	dB	15	20	
ISOL	Isolation, $f = 1$ GHz	dB	27	32	
P_{SAT}	Saturated Output Power, $f = 1$ GHz	dBm		8.5	
IM_3	3rd Order Intermodulation Distortion, $f = 1$ GHz $P_o = 0$ dBm each tone, $f_1 = 1000$ MHz, $f_2 = 1002$ MHz	dBc		-30	

The information in this document is subject to change without notice. Before using this document, please confirm that this is the latest version.

ABSOLUTE MAXIMUM RATINGS¹ (T_A = 25°C)

SYMBOLS	PARAMETERS	UNITS	RATINGS
V _{CC}	Supply Voltage	V	6
I _{CC}	Total Circuit Current	mA	60
P _{IN}	Input Power	dBm	+10
P _T	Total Power Dissipation ²	mW	200
T _{OP}	Operating Temperature	°C	-40 to +85
T _{STG}	Storage Temperature	°C	-55 to +150

Notes:

1. Operation in excess of any one of these parameters may result in permanent damage.
2. Mounted on a 50 x 50 x 1.6 mm epoxy glass PWB (T_A = 85°C).

RECOMMENDED OPERATING CONDITIONS

SYMBOLS	PARAMETERS	UNITS	MIN	TYP	MAX
V _{CC}	Supply Voltage	V	4.5	5.0	5.5

ORDERING INFORMATION (Solder Contains Lead)

PART NUMBER	QTY
UPC2776TB-E3	3K/Reel

Note:

Embossed Tape, 8 mm wide. Pins 1, 2 and 3 face perforated side of tape.

ORDERING INFORMATION (Pb-Free)

PART NUMBER	QTY
UPC2776TB-E3-A	3K/Reel

Note:

Embossed Tape, 8 mm wide. Pins 1, 2 and 3 face perforated side of tape.

TYPICAL PERFORMANCE CURVES (T_A = 25°C)

CURRENT vs. VOLTAGE

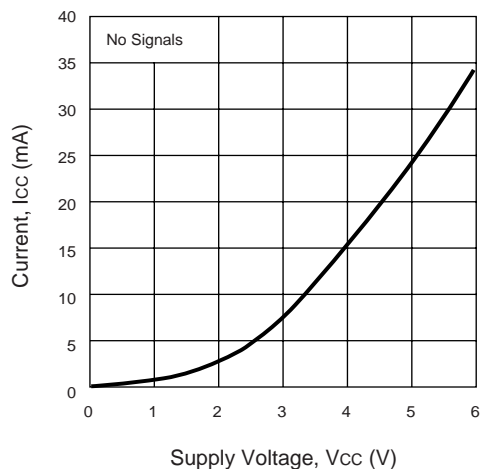

CURRENT vs. TEMPERATURE

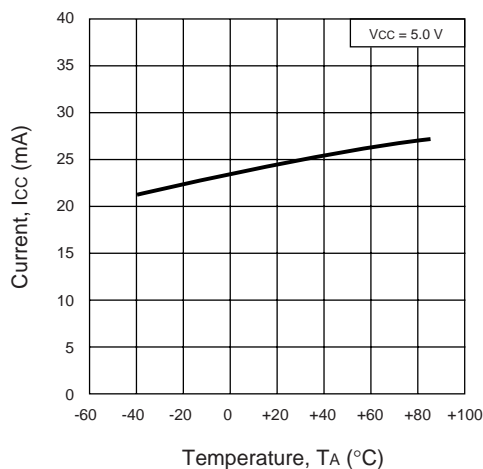

NOISE FIGURE AND GAIN vs. FREQUENCY and VOLTAGE

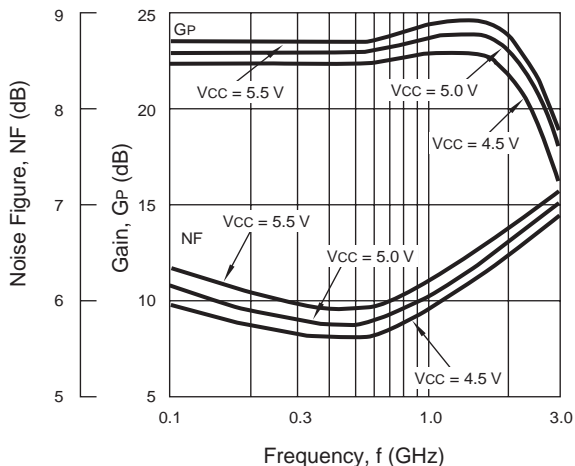

GAIN vs. FREQUENCY and TEMPERATURE

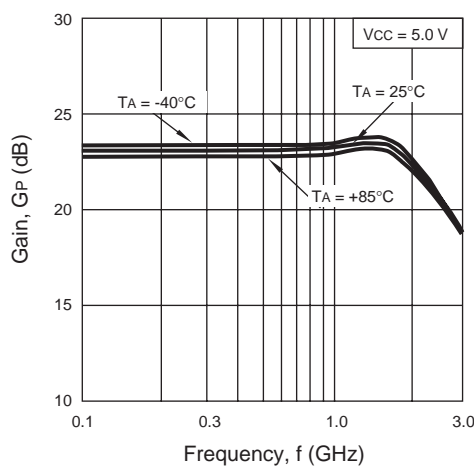

TYPICAL PERFORMANCE CURVES (TA = 25° C)

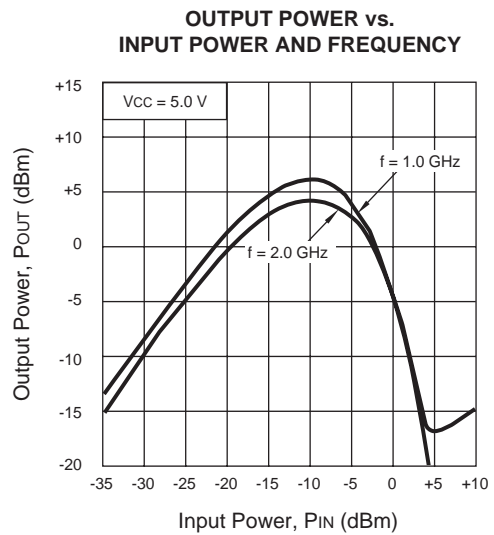
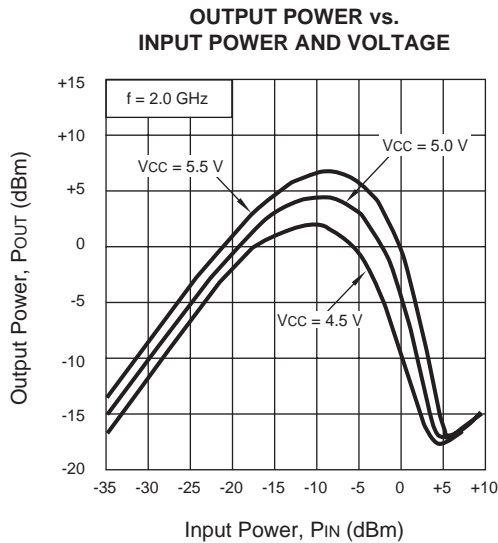
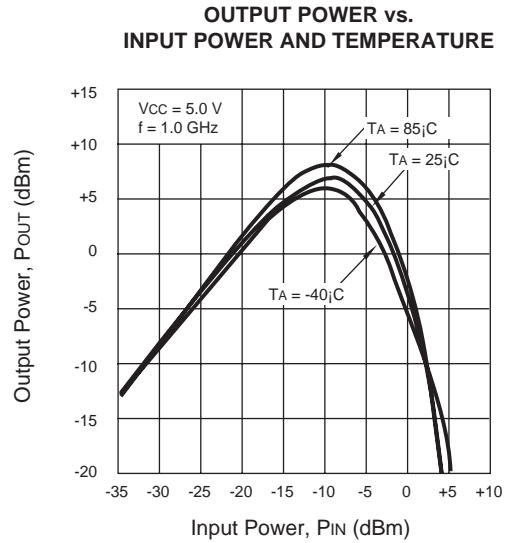
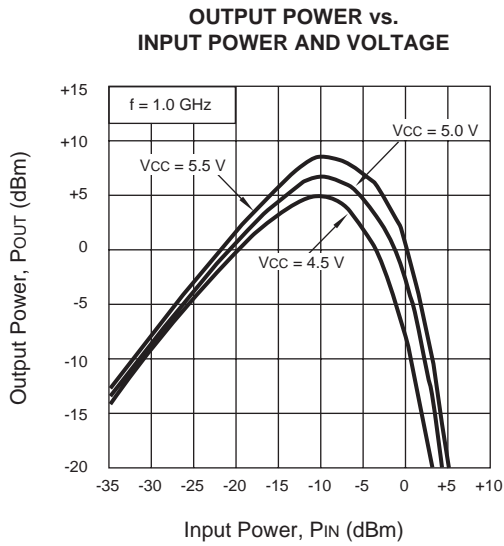
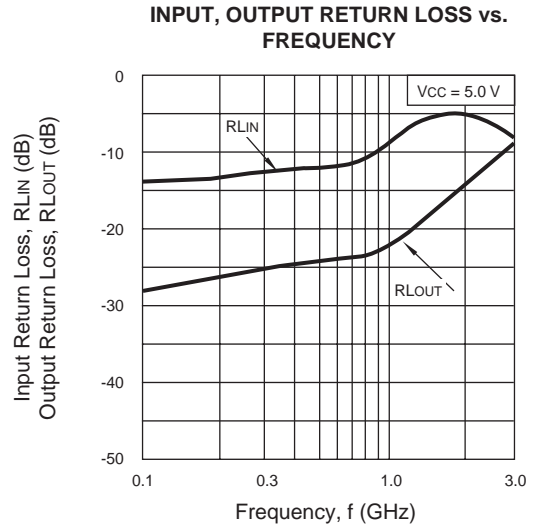
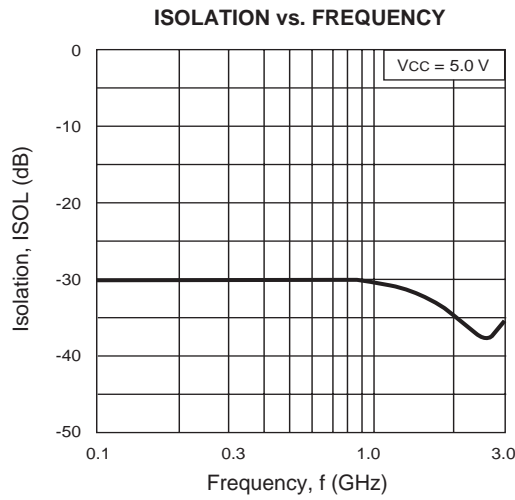

TYPICAL PERFORMANCE CURVES (TA = 25° C)

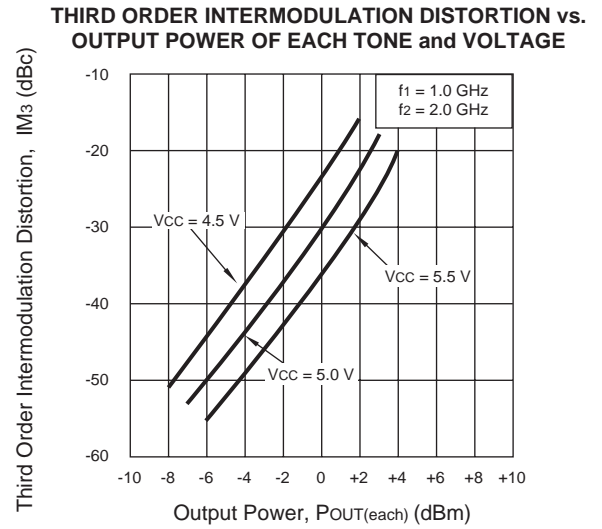
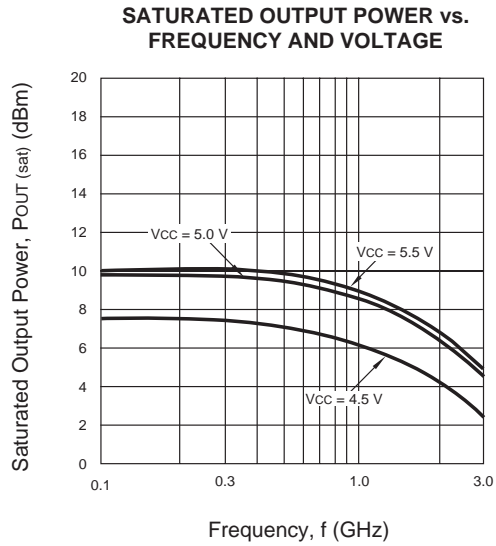

TYPICAL SCATTERING PARAMETERS (T_A = 25°C)

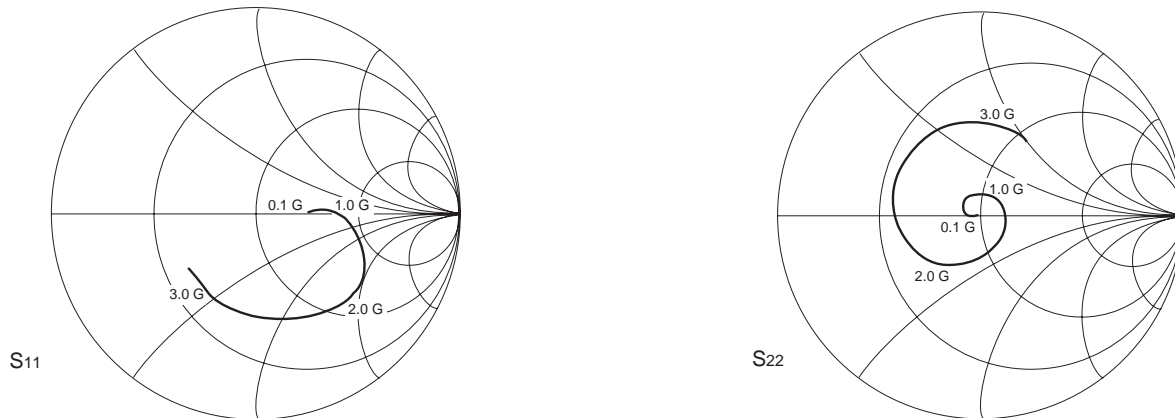

UPC2776TB

V_{CC} = V_{OUT} = 5.0 V, I_{CC} = 27 mA

FREQUENCY GHz	S ₁₁		S ₂₁		S ₁₂		S ₂₂		K
	MAG	ANG	MAG	ANG	MAG	ANG	MAG	ANG	
0.1	0.226	2.8	13.844	-5.9	0.029	-1.5	0.032	-177.4	1.39
0.2	0.240	6.4	13.862	-12.5	0.029	0.3	0.024	-171.9	1.39
0.3	0.254	10.4	13.942	-18.6	0.028	3.2	0.030	-176.3	1.40
0.4	0.267	11.4	14.123	-25.2	0.029	4.8	0.031	-167.6	1.36
0.5	0.285	11.1	14.267	-31.8	0.029	7.2	0.037	-167.3	1.33
0.6	0.308	8.5	14.423	-38.6	0.029	9.3	0.038	-159.3	1.28
0.7	0.345	6.1	14.670	-45.5	0.030	10.7	0.040	-160.7	1.22
0.8	0.386	3.9	14.864	-52.8	0.030	11.0	0.043	-161.9	1.18
0.9	0.425	1.4	15.210	-60.1	0.031	11.9	0.055	-169.0	1.12
1.0	0.449	-1.5	15.455	-68.4	0.030	11.7	0.072	-169.1	1.10
1.1	0.466	-6.1	15.564	-76.6	0.030	10.6	0.084	-169.1	1.08
1.2	0.478	-12.0	15.550	-84.9	0.030	11.7	0.093	-173.6	1.07
1.3	0.507	-17.7	15.622	-93.1	0.030	13.4	0.094	177.9	1.05
1.4	0.533	-24.7	15.577	-101.3	0.029	13.2	0.114	167.0	1.05
1.5	0.564	-30.3	15.527	-110.6	0.029	13.5	0.130	164.1	1.02
1.6	0.568	-36.4	15.285	-119.0	0.027	11.3	0.154	158.0	1.07
1.7	0.576	-42.0	14.960	-127.8	0.026	12.6	0.167	152.6	1.09
1.8	0.571	-48.5	14.570	-136.4	0.024	14.8	0.179	143.0	1.18
1.9	0.570	-54.5	14.026	-144.7	0.023	15.8	0.196	135.2	1.27
2.0	0.569	-59.7	13.715	-151.7	0.022	18.2	0.212	128.1	1.35
2.1	0.564	-64.2	13.283	-159.8	0.020	23.5	0.228	121.6	1.48
2.2	0.548	-69.6	12.926	-167.5	0.018	27.1	0.240	115.9	1.66
2.3	0.535	-75.5	12.515	-174.8	0.018	36.3	0.251	108.1	1.75
2.4	0.516	-81.8	12.093	-177.9	0.016	41.9	0.268	102.4	2.01
2.5	0.515	-87.0	11.498	170.1	0.017	53.3	0.279	96.0	1.99
2.6	0.508	-90.9	11.136	163.1	0.015	64.3	0.296	90.8	2.22
2.7	0.503	-94.8	10.511	156.6	0.015	67.9	0.306	86.7	2.29
2.8	0.489	-97.6	10.126	148.3	0.018	85.0	0.315	79.2	2.00
2.9	0.471	-101.3	9.850	143.2	0.019	993.7	0.330	73.0	1.96
3.0	0.457	-106.7	9.242	135.5	0.022	100.0	0.343	67.0	1.81
3.1	0.455	-111.3	9.065	128.9	0.026	108.0	0.357	60.7	1.53

PIN DESCRIPTIONS

Pin No.	Symbol	Applied Voltage	Description	Internal Equivalent Circuit
1	Input	–	RF signal input pin. An internal matching circuit, configured with resistors, improves match to 50 Ω over a wide band. A multi-feedback circuit is incorporated to minimize variations in h _{FE} and resistance values.	
2 3 5	GND	0	Ground pins. From the ground pattern as large as possible to minimize ground impedance.	
4	Output	4.5 to 5.5	RF signal output pin. Connect an inductor between this pin and Vcc to supply current to the internal output transistors.	
6	Vcc		Power supply pin. This pin biases the internal input transistor.	

OUTLINE DIMENSIONS (Units in mm)

PACKAGE OUTLINE S06

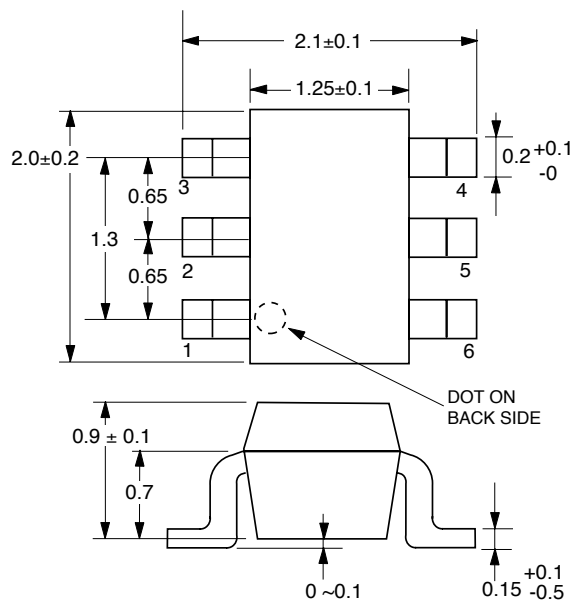

Note: All dimensions are typical unless otherwise specified.

LEAD CONNECTIONS

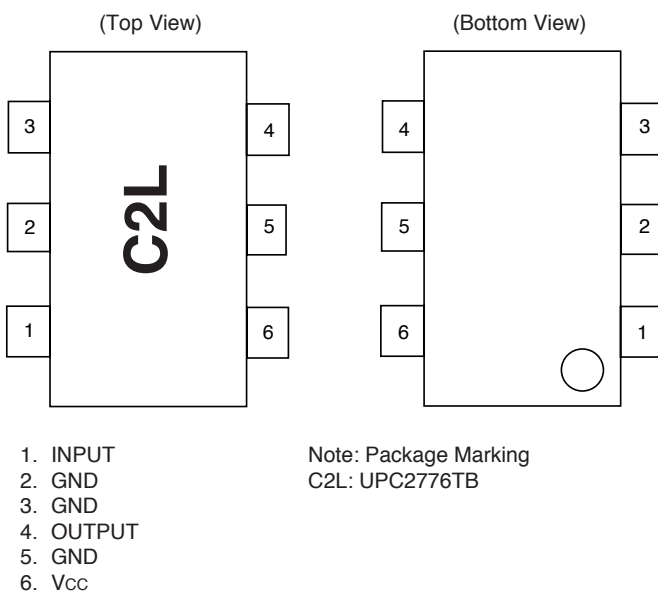

Note: Package Marking
C2L: UPC2776TB