

### FEATURES

- **HIGH GAIN BANDWIDTH:**  
f<sub>T</sub> = 20 GHz
- **HIGH OUTPUT POWER:**  
P<sub>-1dB</sub> = 26 dBm at 1.8 GHz
- **HIGH LINEAR GAIN:**  
G<sub>L</sub> = 12 dB at 1.8 GHz
- **LOW PROFILE M04 PACKAGE:**  
SOT-343 footprint, with a height of only 0.59 mm  
Flat lead style for better RF performance

### DESCRIPTION

NEC's NE664M04 is fabricated using NEC's state-of-the-art UHS0 25 GHz f<sub>T</sub> wafer process. With a transition frequency of 20 GHz, the NE664M04 is usable in applications from 100 MHz to over 3 GHz. The NE664M04 provides P<sub>1dB</sub> of 26 dBm, even with low voltage and low current, making this device an excellent choice for the output or driver stage for mobile or fixed wireless applications.

The NE664M04 is housed in NEC's low profile/flat lead style "M04" package

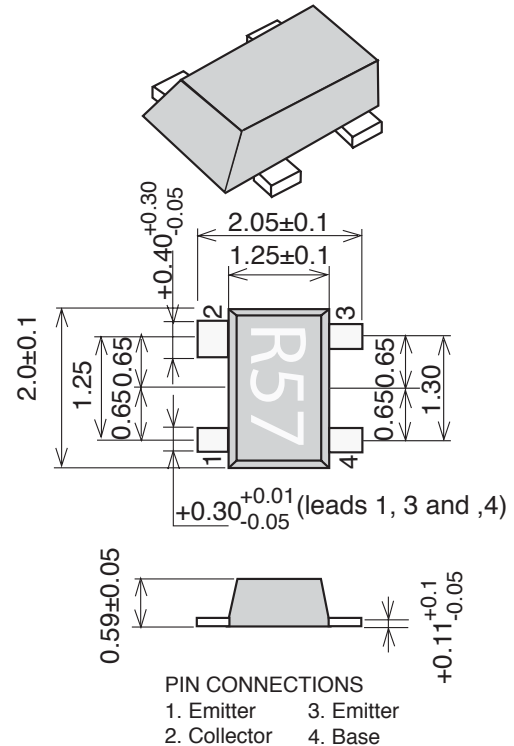

### ELECTRICAL CHARACTERISTICS (T<sub>A</sub> = 25°C)

PART NUMBER PACKAGE OUTLINE EIAJ <sup>3</sup> REGISTRATION NUMBER			NE664M04 M04 2SC5754			
	SYMBOLS	PARAMETERS AND CONDITIONS	UNITS	MIN	TYP	MAX
DC	I <sub>CBO</sub>	Collector Cutoff Current at V <sub>CB</sub> = 5V, I <sub>E</sub> = 0	nA			1000
	I <sub>EBO</sub>	Emitter Cutoff Current at V <sub>EB</sub> = 1 V, I <sub>C</sub> = 0	nA			1000
	h <sub>FE</sub>	DC Current <sup>1</sup> Gain at V <sub>CE</sub> = 3 V, I <sub>C</sub> = 100 mA		40	60	100
RF	P <sub>1dB</sub>	Output Power at 1 dB compression point at V <sub>CE</sub> = 3.6 V, I <sub>CQ</sub> = 4 mA, f = 1.8 GHz, P <sub>in</sub> = 15 dBm, 1/2 Duty Cycle	dBm		26.0	
	G <sub>L</sub>	Linear Gain at V <sub>CE</sub> = 3.6 V, I <sub>CQ</sub> = 20 mA, f = 1.8 GHz, P <sub>in</sub> = 0 dBm, 1/2 Duty Cycle	dB		12.0	
	MAG	Maximum Available Power Gain <sup>4</sup> at V <sub>CE</sub> = 3 V, I <sub>C</sub> = 100 mA, f = 2 GHz	dBm		12.0	
	S <sub>21</sub>   <sup>2</sup>	Insertion Power Gain at V <sub>CE</sub> = 3 V, I <sub>C</sub> = 100 mA, f = 2 GHz	dB	5.0	6.5	
	η <sub>c</sub>	Collector Efficiency, 3.6 V, I <sub>CQ</sub> = 4 mA, f = 1.8 GHz, P <sub>in</sub> = 15 dBm, 1/2 Duty Cycle	%		60	
	f <sub>T</sub>	Gain Bandwidth at V <sub>CE</sub> = 3 V, I <sub>C</sub> = 100 mA, f = 0.5 GHz	GHz	16	20	
	C <sub>re</sub>	Feedback Capacitance <sup>2</sup> at V <sub>CB</sub> = 3 V, I <sub>C</sub> = 0, f = 1 MHz	pF		1.0	1.5

Notes:

1. Pulsed measurement, pulse width ≤ 350 μs, duty cycle ≤ 2 %.
2. Collector to Base capacitance measured by capacitance meter (automatic balance bridge method) when emitter pin is connected to the guard pin of capacitance meter.
3. Electronic Industrial Association of Japan

$$4. \text{MAG} = \frac{|S_{21}|}{|S_{12}|} \left( K - \sqrt{K^2 - 1} \right)$$

# NE664M04

## ABSOLUTE MAXIMUM RATINGS<sup>1</sup> (T<sub>A</sub> = 25°C)

SYMBOLS	PARAMETERS	UNITS	RATINGS
V <sub>CB0</sub>	Collector to Base Voltage	V	13
V <sub>CE0</sub>	Collector to Emitter Voltage	V	5.0
V <sub>EB0</sub>	Emitter to Base Voltage	V	1.5
I <sub>C</sub>	Collector Current	mA	500
P <sub>T</sub>	Total Power Dissipation <sup>2</sup>	mW	735
T <sub>J</sub>	Junction Temperature	°C	150
T <sub>STG</sub>	Storage Temperature	°C	-65 to +150

Note:

1. Operation in excess of any one of these parameters may result in permanent damage.
2. Mounted on 38 x 38 mm, t = 0.4 mm polyimide PCB.

## ORDERING INFORMATION

PART NUMBER	QUANTITY
NE664M04-T2-A	3k pcs./reel

## THERMAL RESISTANCE

SYMBOLS	PARAMETERS	UNITS	RATINGS
R <sub>th j-a1</sub>	Junction to Ambient Resistance <sup>1</sup>	°C/W	170
R <sub>th j-a2</sub>	Junction to Ambient Resistance <sup>2</sup>	°C/W	570

Note:

1. Mounted on 38 x 38 mm, t = 0.4 mm polyimide PCB.
2. Stand alone device in free air.

## APPLICATIONS

Bluetooth Power Class 1  
f = 2.4 GHz

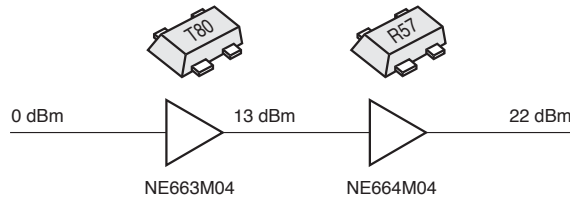

SS Cordless Phone  
f = 2.4 GHz

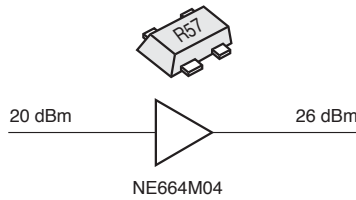

DCS1800 (GSM1800) Cellular Phone  
f = 1.8 GHz

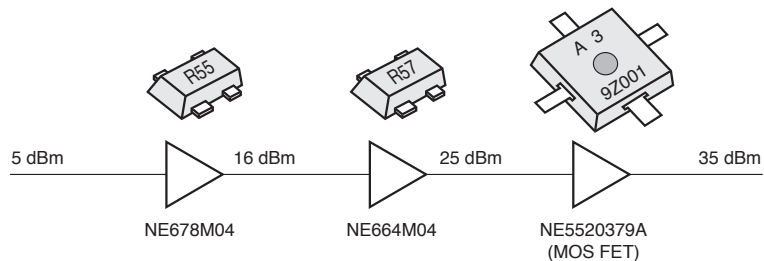

Cordless Phone  
f = 0.9 GHz

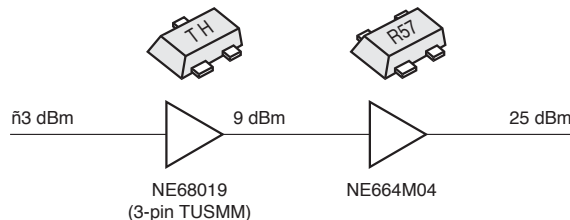

**TYPICAL PERFORMANCE CURVES** ( $T_A = 25^\circ\text{C}$ )

**TOTAL POWER DISSIPATION vs. AMBIENT TEMPERATURE**

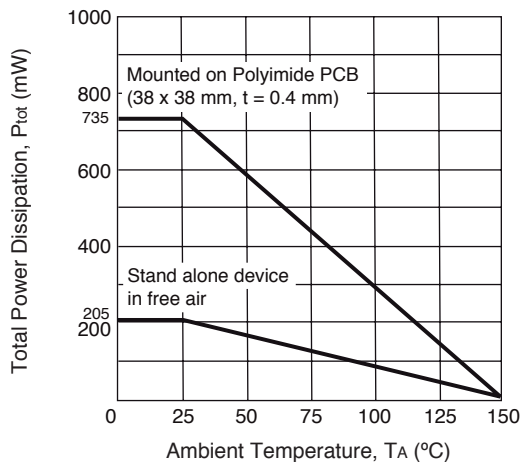

**REVERSE TRANSFER CAPACITANCE vs. COLLECTOR TO BASE VOLTAGE**

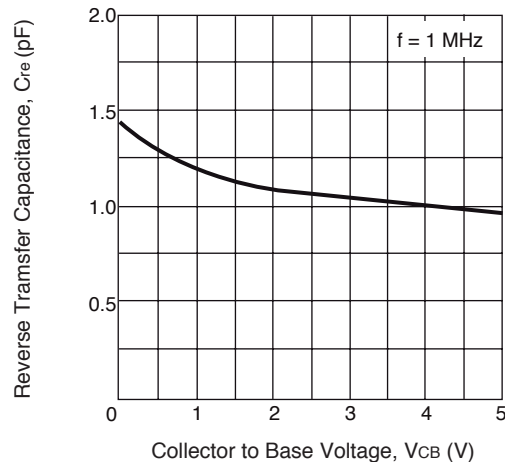

**COLLECTOR CURRENT vs. BASE TO EMITTER VOLTAGE**

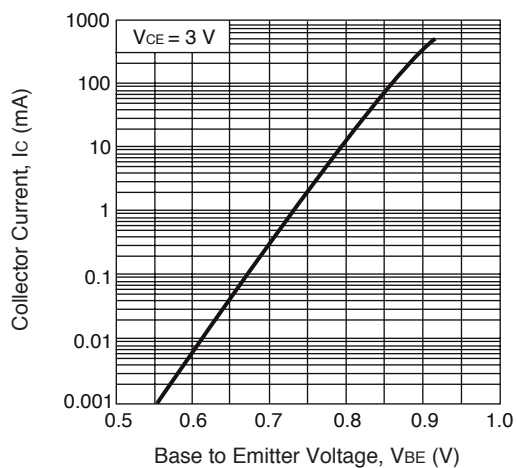

**COLLECTOR CURRENT vs. COLLECTOR TO EMITTER VOLTAGE**

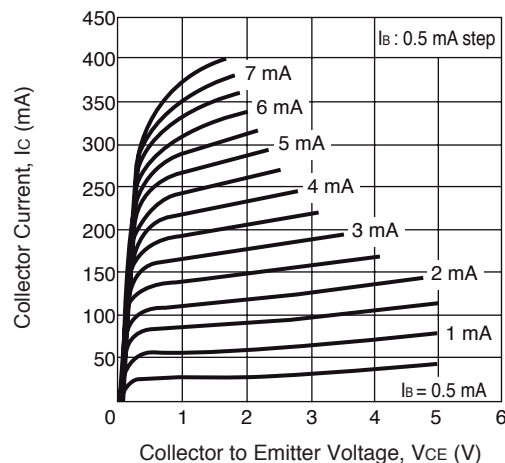

**DC CURRENT GAIN vs. COLLECTOR CURRENT**

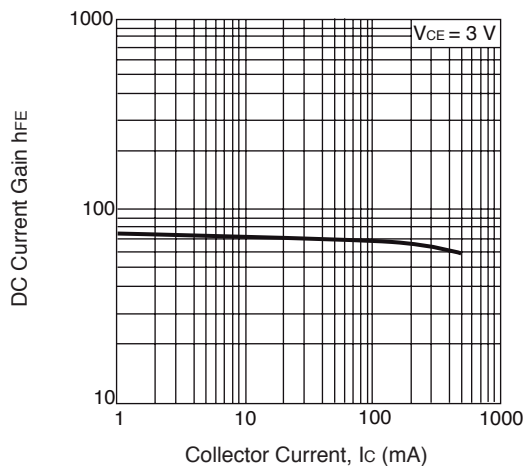

TYPICAL PERFORMANCE CURVES (T<sub>A</sub> = 25°C)

GAIN BANDWIDTH PRODUCT vs. COLLECTOR CURRENT

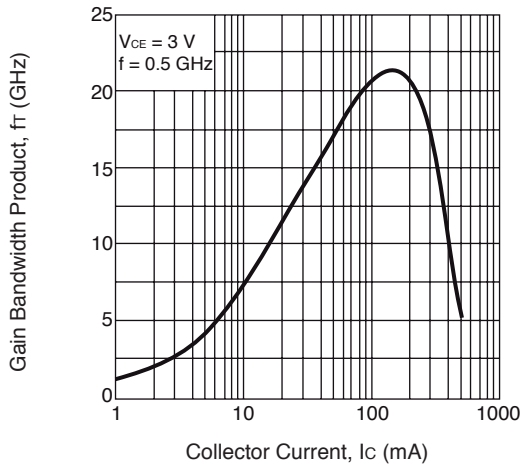

INSERTION POWER GAIN, MAG, MSG vs. FREQUENCY

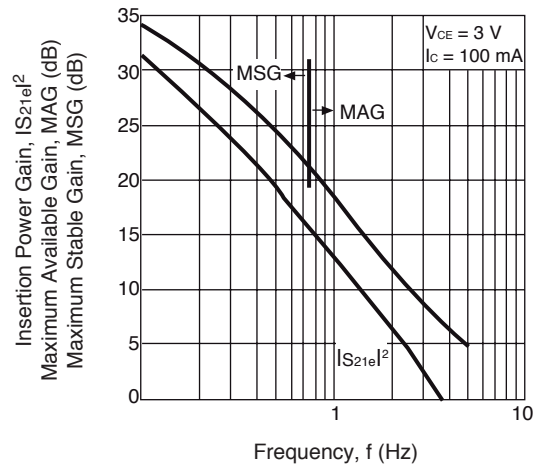

INSERTION POWER GAIN, MAG, MSG vs. COLLECTOR CURRENT

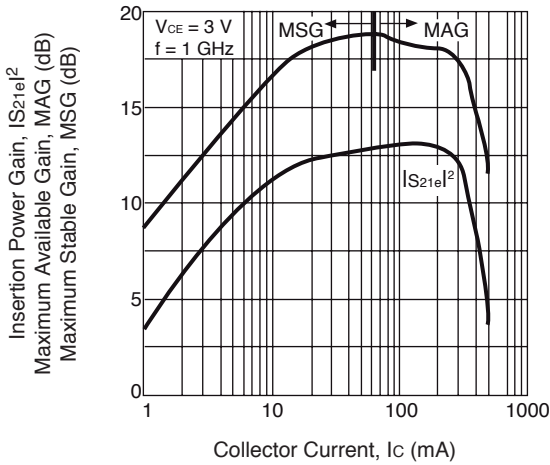

INSERTION POWER GAIN, MAG, MSG vs. COLLECTOR CURRENT

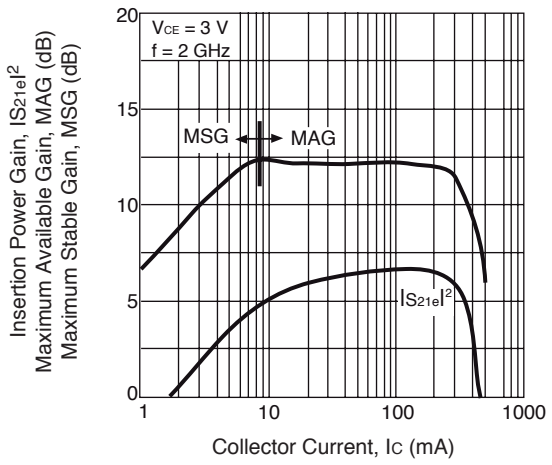

INSERTION POWER GAIN, MAG, MSG vs. COLLECTOR CURRENT

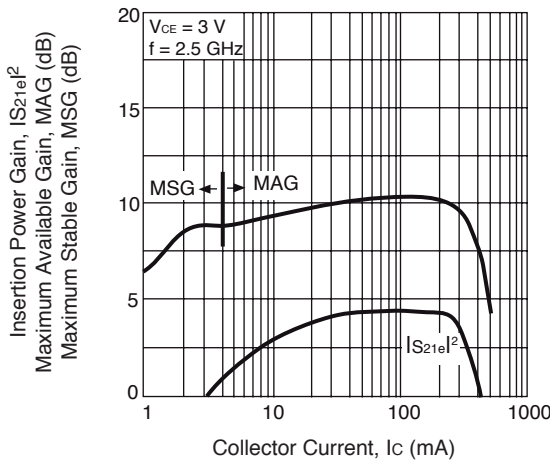

**TYPICAL PERFORMANCE CURVES** ( $T_A = 25^\circ\text{C}$ )

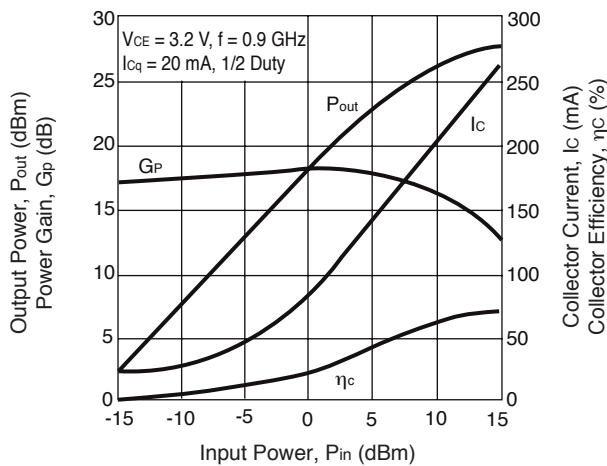
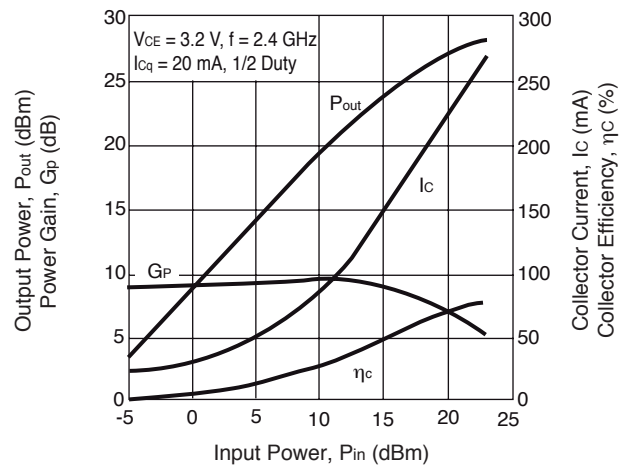
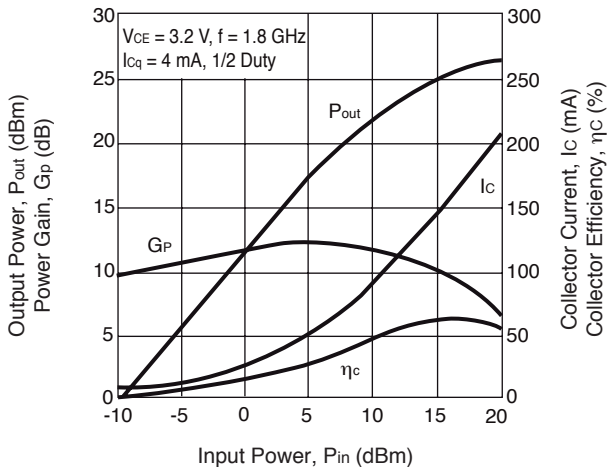
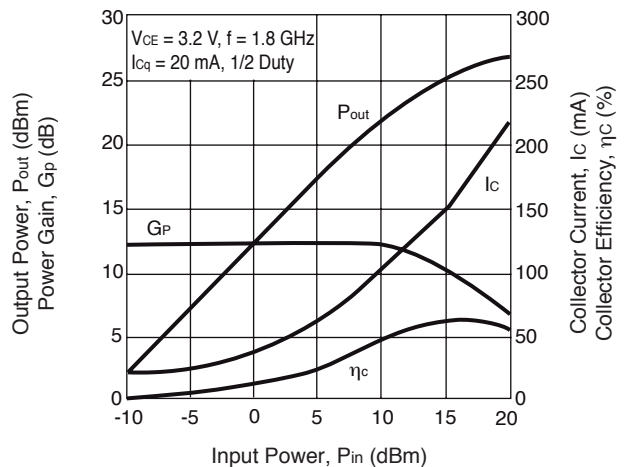
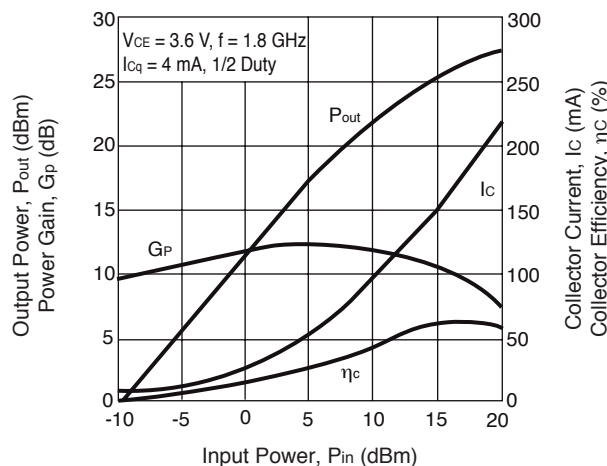
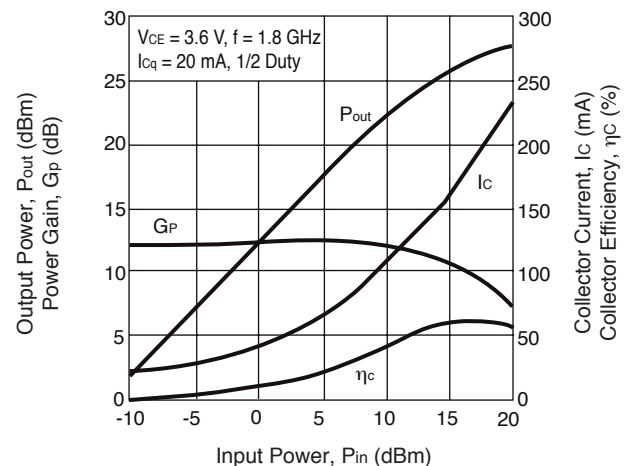
**OUTPUT POWER, POWER GAIN, COLLECTOR CURRENT,  
& COLLECTOR EFFICIENCY  
vs. INPUT POWER**

**OUTPUT POWER, POWER GAIN, COLLECTOR CURRENT,  
& COLLECTOR EFFICIENCY  
vs. INPUT POWER**

**OUTPUT POWER, POWER GAIN, COLLECTOR CURRENT,  
& COLLECTOR EFFICIENCY  
vs. INPUT POWER**

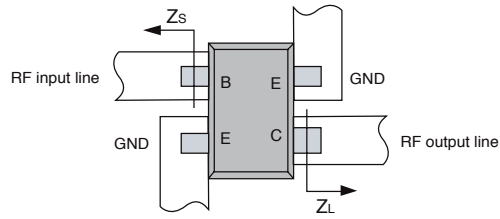
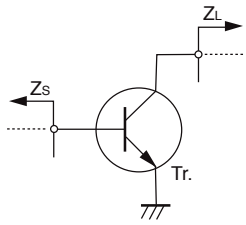
**OUTPUT POWER, POWER GAIN, COLLECTOR CURRENT,  
& COLLECTOR EFFICIENCY  
vs. INPUT POWER**

**OUTPUT POWER, POWER GAIN, COLLECTOR CURRENT,  
& COLLECTOR EFFICIENCY  
vs. INPUT POWER**

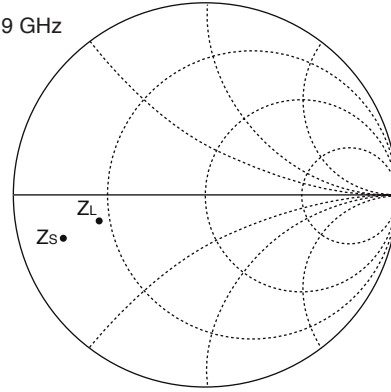
**OUTPUT POWER, POWER GAIN, COLLECTOR CURRENT,  
& COLLECTOR EFFICIENCY  
vs. INPUT POWER**

**LARGE SIGNAL IMPEDANCES**

FREQUENCY f (GHz)	COLLECTOR TO EMITTER VOLTAGE $V_{CE}$ (V)	SOURCE IMPEDANCE $Z_s$ ( $\Omega$ )	LOAD IMPEDANCE $Z_L$ ( $\Omega$ )
0.9	2.8 to 3.6	8.4 - 5.2j	15.1- 4.3j
1.8	2.8 to 3.6	6.3 - 16.4j	15.8- 6.9j
2.4	2.8 to 3.6	5.9 - 22.1j	15.2- 17.9j



f = 0.9 GHz



f = 1.8 GHz

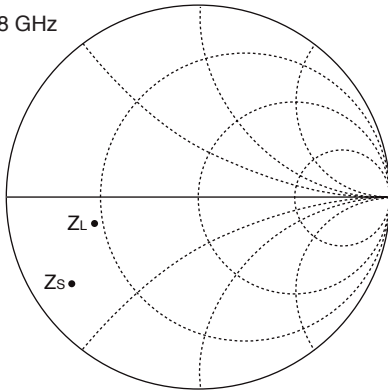

f = 2.4 GHz

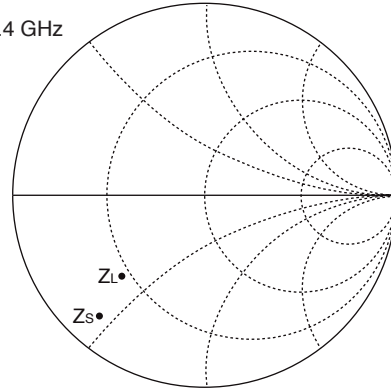

**TYPICAL SCATTERING PARAMETERS** (T<sub>A</sub> = 25°C)

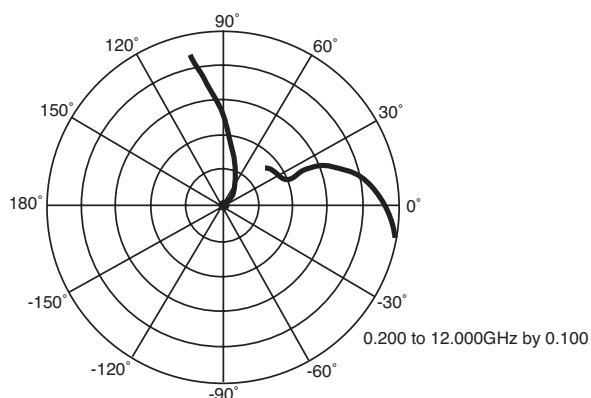
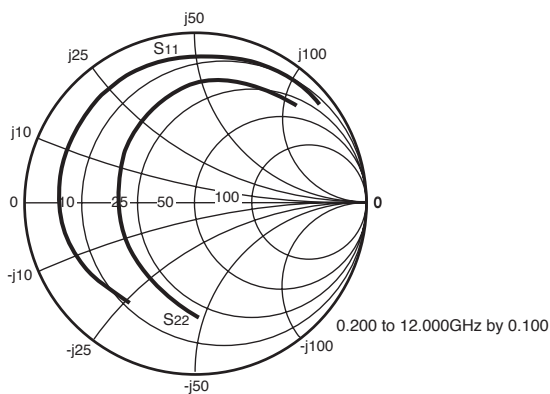

**NE664M04**

V<sub>c</sub> = 1 V, I<sub>c</sub> = 10 mA

FREQUENCY	S <sub>11</sub>		S <sub>21</sub>		S <sub>12</sub>		S <sub>22</sub>		K	MAG <sup>1</sup>
GHz	MAG	ANG	MAG	ANG	MAG	ANG	MAG	ANG		(dB)
0.50	0.784	-161.6	6.573	95.1	0.075	19.0	0.491	-138.6	0.32	19.44
1.00	0.801	178.1	3.389	77.6	0.081	16.3	0.454	-164.9	0.60	16.23
1.50	0.810	166.2	2.271	65.1	0.084	18.9	0.460	-178.3	0.85	14.33
2.00	0.812	157.2	1.710	54.4	0.090	18.1	0.467	172.5	1.03	11.77
2.50	0.820	149.0	1.378	44.3	0.097	20.8	0.476	165.3	1.16	9.14
3.00	0.827	141.5	1.163	35.2	0.109	20.6	0.482	158.0	1.20	7.60
3.50	0.834	133.6	1.013	26.1	0.119	18.7	0.498	151.0	1.22	6.47
4.00	0.838	125.9	0.901	17.1	0.133	16.2	0.508	143.9	1.22	5.49
4.50	0.845	118.0	0.816	8.6	0.146	11.6	0.525	136.4	1.19	4.84
5.00	0.850	110.4	0.743	0.1	0.160	8.6	0.546	128.9	1.17	4.15
5.50	0.855	102.3	0.678	- 7.5	0.170	5.7	0.570	121.9	1.19	3.40
6.00	0.861	95.2	0.624	- 14.9	0.175	0.9	0.599	115.4	1.18	2.93
6.50	0.866	88.6	0.573	- 21.9	0.190	- 3.9	0.625	108.6	1.15	2.44
7.00	0.874	82.3	0.530	- 28.0	0.195	- 7.7	0.650	102.4	1.14	2.05
7.50	0.881	76.5	0.485	- 34.0	0.198	- 12.6	0.676	95.6	1.14	1.58
8.00	0.889	72.0	0.451	- 38.9	0.203	- 17.2	0.696	89.6	1.13	1.29
8.50	0.898	67.3	0.422	- 44.1	0.211	- 21.6	0.716	83.0	1.09	1.14
9.00	0.905	63.5	0.391	- 48.5	0.205	- 25.6	0.733	76.4	1.11	0.76
9.50	0.911	60.2	0.360	- 52.4	0.208	- 30.2	0.740	70.9	1.11	0.34
10.00	0.916	56.1	0.337	- 56.3	0.208	- 33.9	0.768	63.4	1.12	0.01
10.50	0.917	52.2	0.321	- 60.0	0.209	- 38.7	0.782	58.1	1.12	- 0.24
11.00	0.926	48.4	0.305	- 64.1	0.210	- 42.2	0.793	53.2	1.09	- 0.27
11.50	0.923	44.4	0.295	- 66.4	0.208	- 46.5	0.811	49.2	1.11	- 0.52
12.00	0.931	40.0	0.290	- 69.9	0.221	- 50.7	0.816	46.3	1.06	- 0.27

Note:

1. Gain Calculations:

$$MAG = \frac{|S_{21}|}{|S_{12}|} \left( K \pm \sqrt{K^2 - 1} \right). \text{ When } K \leq 1, \text{ MAG is undefined and MSG values are used. } MSG = \frac{|S_{21}|}{|S_{12}|}, K = \frac{1 + |\Delta|^2 - |S_{11}|^2 - |S_{22}|^2}{2 |S_{12} S_{21}|}, \Delta = S_{11} S_{22} - S_{21} S_{12}$$

MAG = Maximum Available Gain

MSG = Maximum Stable Gain

TYPICAL SCATTERING PARAMETERS (T<sub>A</sub> = 25°C)

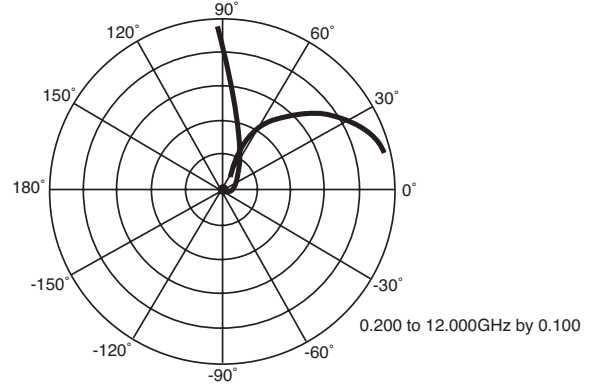
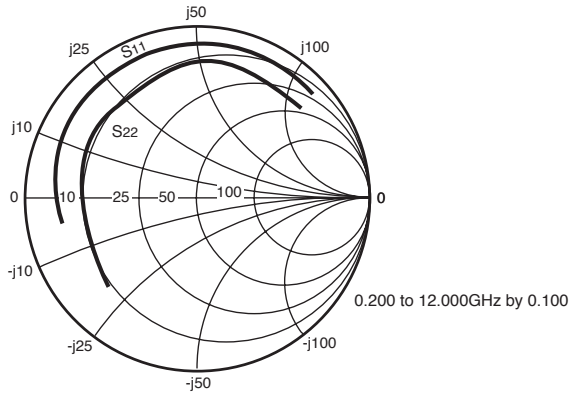

NE664M04

V<sub>c</sub> = 2 V, I<sub>c</sub> = 100 mA

FREQUENCY	S <sub>11</sub>		S <sub>21</sub>		S <sub>12</sub>		S <sub>22</sub>		K	MAG <sup>1</sup> (dB)
	MAG	ANG	MAG	ANG	MAG	ANG	MAG	ANG		
0.50	0.808	177.3	9.415	90.1	0.027	50.0	0.652	-167.8	0.87	25.50
1.00	0.812	167.0	4.762	77.9	0.046	62.1	0.650	176.3	1.04	18.88
1.50	0.819	158.7	3.176	68.6	0.065	57.6	0.657	166.5	1.07	15.33
2.00	0.822	151.3	2.387	60.0	0.083	53.6	0.662	158.5	1.08	12.85
2.50	0.830	143.8	1.925	51.6	0.106	48.0	0.666	151.4	1.06	11.12
3.00	0.831	137.2	1.616	43.8	0.123	43.3	0.670	144.1	1.07	9.60
3.50	0.834	129.9	1.410	36.0	0.140	37.1	0.669	137.0	1.07	8.45
4.00	0.837	122.8	1.256	27.7	0.159	30.9	0.672	129.3	1.06	7.52
4.50	0.836	115.1	1.138	19.7	0.175	25.2	0.680	121.7	1.06	6.61
5.00	0.843	107.7	1.035	12.1	0.188	18.1	0.691	114.7	1.06	5.96
5.50	0.843	100.1	0.945	4.4	0.197	11.6	0.701	108.2	1.06	5.25
6.00	0.851	93.1	0.868	- 2.5	0.207	6.4	0.715	101.9	1.06	4.71
6.50	0.857	86.5	0.800	- 9.0	0.212	- 0.2	0.731	95.8	1.06	4.23
7.00	0.865	80.8	0.742	- 15.3	0.222	- 4.7	0.745	90.2	1.06	3.80
7.50	0.866	75.4	0.688	- 21.2	0.225	- 10.8	0.751	84.5	1.07	3.29
8.00	0.874	70.6	0.641	- 26.6	0.225	- 15.7	0.761	78.7	1.07	2.94
8.50	0.883	66.5	0.591	- 32.4	0.227	- 19.8	0.772	72.4	1.07	2.56
9.00	0.891	62.6	0.551	- 37.1	0.231	- 25.9	0.774	66.3	1.06	2.24
9.50	0.900	59.2	0.517	- 43.0	0.221	- 30.6	0.788	60.8	1.06	2.17
10.00	0.902	55.6	0.491	- 47.2	0.226	- 34.5	0.796	54.7	1.07	1.80
10.50	0.914	51.8	0.456	- 52.1	0.219	- 39.4	0.805	49.5	1.06	1.69
11.00	0.918	48.1	0.435	- 56.2	0.219	- 43.8	0.810	45.5	1.05	1.54
11.50	0.917	44.1	0.419	- 60.1	0.219	- 47.4	0.822	41.9	1.06	1.31
12.00	0.917	39.7	0.413	- 63.7	0.229	- 50.6	0.822	38.8	1.05	1.13

Note:

1. Gain Calculations:

$$MAG = \frac{|S_{21}|}{|S_{12}|} \left( K \pm \sqrt{K^2 - 1} \right). \text{ When } K \leq 1, \text{ MAG is undefined and MSG values are used. } MSG = \frac{|S_{21}|}{|S_{12}|}, K = \frac{1 + |\Delta|^2 - |S_{11}|^2 - |S_{22}|^2}{2 |S_{12} S_{21}|}, \Delta = S_{11} S_{22} - S_{21} S_{12}$$

MAG = Maximum Available Gain

MSG = Maximum Stable Gain



**TYPICAL SCATTERING PARAMETERS** (T<sub>A</sub> = 25°C)

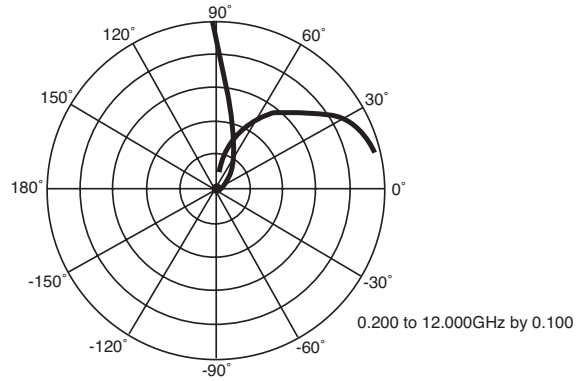
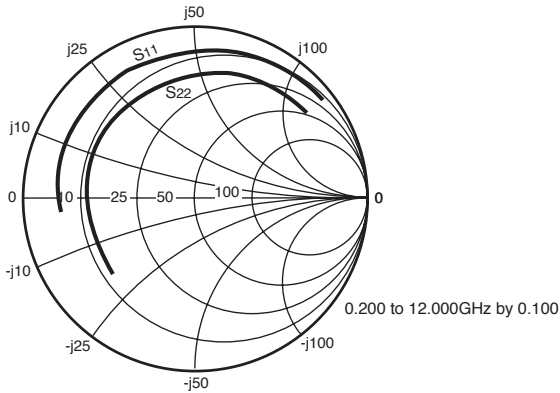

**NE664M04**

V<sub>c</sub> = 3 V, I<sub>c</sub> = 200 mA

FREQUENCY	S <sub>11</sub>		S <sub>21</sub>		S <sub>12</sub>		S <sub>22</sub>		K	MAG <sup>1</sup>
GHz	MAG	ANG	MAG	ANG	MAG	ANG	MAG	ANG		(dB)
0.50	0.801	175.9	9.856	89.7	0.024	66.8	0.624	-169.4	1.01	25.43
1.00	0.808	166.3	4.975	77.5	0.044	68.0	0.632	175.5	1.07	18.85
1.50	0.815	158.4	3.310	68.2	0.066	62.1	0.633	166.7	1.07	15.41
2.00	0.819	150.9	2.483	59.8	0.084	57.6	0.638	158.1	1.08	12.95
2.50	0.822	143.9	1.996	51.6	0.102	52.3	0.644	150.8	1.09	11.11
3.00	0.830	136.8	1.676	43.6	0.122	43.9	0.648	144.1	1.07	9.80
3.50	0.832	129.7	1.461	35.8	0.138	39.2	0.653	136.7	1.07	8.62
4.00	0.831	122.5	1.299	27.6	0.156	32.6	0.656	129.3	1.07	7.59
4.50	0.835	115.0	1.171	19.8	0.173	26.9	0.662	122.1	1.07	6.75
5.00	0.837	107.6	1.069	12.0	0.187	19.5	0.672	114.9	1.06	6.05
5.50	0.842	100.2	0.979	4.4	0.198	11.8	0.683	108.2	1.06	5.44
6.00	0.848	93.0	0.896	- 2.8	0.211	7.0	0.698	102.1	1.06	4.83
6.50	0.853	86.4	0.828	- 9.1	0.214	1.2	0.711	96.2	1.06	4.32
7.00	0.862	80.5	0.764	- 15.4	0.216	- 4.7	0.724	90.6	1.06	3.92
7.50	0.868	75.4	0.707	- 21.5	0.226	- 9.8	0.736	85.1	1.06	3.47
8.00	0.873	70.4	0.660	- 26.8	0.231	- 15.6	0.748	78.9	1.06	3.08
8.50	0.881	66.5	0.611	- 32.7	0.223	- 20.4	0.750	72.7	1.07	2.72
9.00	0.890	62.7	0.572	- 36.9	0.226	- 24.0	0.764	67.2	1.07	2.45
9.50	0.895	59.3	0.532	- 42.0	0.226	- 30.2	0.771	61.0	1.07	2.11
10.00	0.903	55.7	0.498	- 47.9	0.219	- 33.8	0.779	55.0	1.07	1.91
10.50	0.911	52.0	0.466	- 51.7	0.224	- 38.3	0.793	48.9	1.06	1.64
11.00	0.915	48.3	0.445	- 56.3	0.219	- 43.0	0.794	45.8	1.06	1.53
11.50	0.919	44.1	0.430	- 60.1	0.226	- 46.2	0.810	41.6	1.05	1.40
12.00	0.918	39.8	0.426	- 64.6	0.229	- 49.5	0.811	39.3	1.05	1.34

Note:

1. Gain Calculations:

$$MAG = \frac{|S_{21}|}{|S_{12}|} (K \pm \sqrt{K^2 - 1}). \text{ When } K \leq 1, \text{ MAG is undefined and MSG values are used. } MSG = \frac{|S_{21}|}{|S_{12}|}, K = \frac{1 + |\Delta|^2 - |S_{11}|^2 - |S_{22}|^2}{2 |S_{12} S_{21}|}, \Delta = S_{11} S_{22} - S_{21} S_{12}$$

MAG = Maximum Available Gain

MSG = Maximum Stable Gain

Life Support Applications

These NEC products are not intended for use in life support devices, appliances, or systems where the malfunction of these products can reasonably be expected to result in personal injury. The customers of CEL using or selling these products for use in such applications do so at their own risk and agree to fully indemnify CEL for all damages resulting from such improper use or sale.

**CEL** California Eastern Laboratories, Your source for NEC RF, Microwave, Optoelectronic, and Fiber Optic Semiconductor Devices.

4590 Patrick Henry Drive • Santa Clara, CA 95054-1817 • (408) 988-3500 • FAX (408) 988-0279 • www.cel.com

DATA SUBJECT TO CHANGE WITHOUT NOTICE

04/04/2003

Subject: Compliance with EU Directives

CEL certifies, to its knowledge, that semiconductor and laser products detailed below are compliant with the requirements of European Union (EU) Directive 2002/95/EC Restriction on Use of Hazardous Substances in electrical and electronic equipment (RoHS) and the requirements of EU Directive 2003/11/EC Restriction on Penta and Octa BDE.

CEL Pb-free products have the same base part number with a suffix added. The suffix –A indicates that the device is Pb-free. The –AZ suffix is used to designate devices containing Pb which are exempted from the requirement of RoHS directive (\*). In all cases the devices have Pb-free terminals. All devices with these suffixes meet the requirements of the RoHS directive.

This status is based on CEL’s understanding of the EU Directives and knowledge of the materials that go into its products as of the date of disclosure of this information.

Restricted Substance per RoHS	Concentration Limit per RoHS (values are not yet fixed)	Concentration contained in CEL devices	
		-A	-AZ
Lead (Pb)	< 1000 PPM	Not Detected	(*)
Mercury	< 1000 PPM	Not Detected	
Cadmium	< 100 PPM	Not Detected	
Hexavalent Chromium	< 1000 PPM	Not Detected	
PBB	< 1000 PPM	Not Detected	
PBDE	< 1000 PPM	Not Detected	

If you should have any additional questions regarding our devices and compliance to environmental standards, please do not hesitate to contact your local representative.

Important Information and Disclaimer: Information provided by CEL on its website or in other communications concerning the substance content of its products represents knowledge and belief as of the date that it is provided. CEL bases its knowledge and belief on information provided by third parties and makes no representation or warranty as to the accuracy of such information. Efforts are underway to better integrate information from third parties. CEL has taken and continues to take reasonable steps to provide representative and accurate information but may not have conducted destructive testing or chemical analysis on incoming materials and chemicals. CEL and CEL suppliers consider certain information to be proprietary, and thus CAS numbers and other limited information may not be available for release.

In no event shall CEL’s liability arising out of such information exceed the total purchase price of the CEL part(s) at issue sold by CEL to customer on an annual basis.

See CEL Terms and Conditions for additional clarification of warranties and liability.