

## 3 V, SILICON MMIC MEDIUM OUTPUT POWER AMPLIFIER FOR MOBILE COMMUNICATIONS

### FEATURES

- **SUPPLY VOLTAGE:**  
 $V_{CC} = 2.7$  to  $3.3$  V
- **CIRCUIT CURRENT:**  
 $I_{CC} = 23.0$  mA TYP at  $V_{CC} = 3.0$  V
- **POWER GAIN:**  
GP = 19.0 dB TYP at  $f = 0.9$  GHz  
GP = 21.0 dB TYP at  $f = 1.9$  GHz  
GP = 22.0 dB TYP at  $f = 2.4$  GHz
- **MEDIUM OUTPUT POWER:**  
 $PO_{(1dB)} = +8.0$  dBm TYP at  $f = 0.9$  GHz  
 $PO_{(1dB)} = +7.0$  dBm TYP at  $f = 1.9$  GHz  
 $PO_{(1dB)} = +7.0$  dBm TYP at  $f = 2.4$  GHz
- **UPPER LIMIT OPERATING FREQUENCY:**  
 $f_U = 4.0$  GHz TYP at 3 dB bandwidth (Standard value)
- **HIGH-DENSITY SURFACE MOUNTING:**  
6-pin super minimold package (2.0 x 1.25 x 0.9 mm)

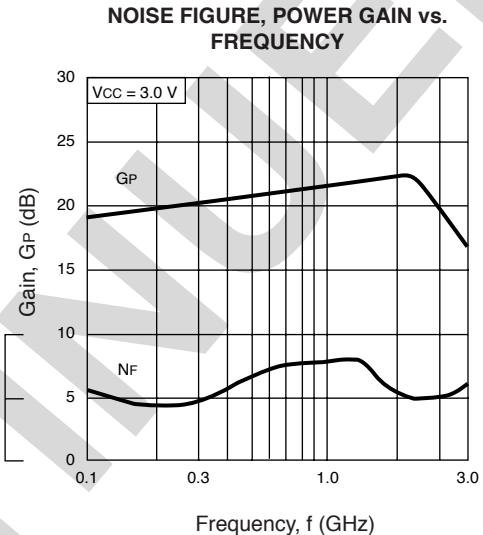

### DESCRIPTION

The UPC8181TB is a silicon Monolithic Microwave Integrated Circuit designed as an amplifier for mobile communications. This IC operates at 3 volts. The medium output power is suitable for RF-TX of mobile communication systems.

This IC is manufactured using the 30 GHz  $f_{max}$  UHSO (Ultra High Speed process) silicon bipolar process. This process uses direct silicon nitride passivation film and gold electrodes. These materials can protect the chip surface from pollution and prevent corrosion/migration. This IC has excellent performance, uniformity, and reliability.

Stringent quality assurance and test procedures ensure the highest reliability and performance.

### ELECTRICAL CHARACTERISTICS

( $T_A = 25^\circ\text{C}$ ,  $V_{CC} = V_{OUT} = 3.0$  V,  $Z_S = Z_L = 50\Omega$ )

PART NUMBER PACKAGE OUTLINE			UPC8181TB S06		
SYMBOLS	PARAMETERS AND CONDITIONS	UNITS	MIN	TYP	MAX
$I_{CC}$	Circuit Current (no signal)	mA	–	23.0	30.0
GP	Power Gain, $f = 0.9$ GHz $f = 1.9$ GHz $f = 2.4$ GHz	dB	16.0 18.0 19.0	19.0 21.0 22.0	22.0 24.0 25.0
NF	Noise Figure, $f = 0.9$ GHz $f = 1.9$ GHz $f = 2.4$ GHz	dB	– – –	4.5 4.5 4.5	6.0 6.0 6.0
$f_U$	Upper Limit Operating Frequency, 3 dB down below from gain at $f = 0.1$ GHz	GHz	–	4.0	–
ISL	Isolation, $f = 0.9$ GHz $f = 1.9$ GHz $f = 2.4$ GHz	dB	28.0 27.0 26.5	33.0 32.0 31.5	– – –

### APPLICATIONS

- Buffer amplifiers for 1.9 GHz to 2.4 GHz mobile communication systems.

**ELECTRICAL CHARACTERISTICS (cont.)**

(TA = 25°C, VCC = VOUT = 3.0 V, ZS = ZL = 50Ω)

PART NUMBER PACKAGE OUTLINE			UPC8181TB S06		
SYMBOLS	PARAMETERS AND CONDITIONS	UNITS	MIN	TYP	MAX
PO(1dB)	1 dB Gain Compression Output Level, f = 0.9 GHz f = 1.9 GHz f = 2.4 GHz	dBm	+5.5 +4.5 +4.5	+8.0 +7.0 +7.0	– – –
PO(SAT)	Saturated Output Power Level, f = 0.9 GHz, PIN = -5 dBm f = 1.9 GHz, PIN = -5 dBm f = 2.4 GHz, PIN = -5 dBm	dBm	– – –	+9.5 +9.0 +9.0	– – –
RLin	Input Return Loss, f = 0.9 GHz f = 1.9 GHz f = 2.4 GHz	dB	4.5 7.5 8.0	7.5 10.5 11.0	– – –
RLout	Output Return Loss, f = 0.9 GHz f = 1.9 GHz f = 2.4 GHz	dB	6.0 7.0 9.0	9.0 10.0 12.0	– – –

**ABSOLUTE MAXIMUM RATINGS<sup>1</sup>**

SYMBOLS	PARAMETERS	UNITS	RATINGS
VCC	Supply Voltage <sup>2</sup>	V	3.6
ICC	Total Circuit Current	mA	60
PD	Power Dissipation <sup>3</sup>	mW	270
TA	Operating Ambient Temperature	°C	-40 to +85
TSTG	Storage Temperature	°C	-55 to +150
PIN	Input Power <sup>4</sup>	dBm	+10

Notes:

1. Operation in excess of any one of these conditions may result in permanent damage.
2. TA = 25°C, pins 4 and 6.
3. Mounted on a double-sided copper clad 50x50x1.6 mm epoxy glass PWB, TA = +85°C.
4. TA = +25 °C

**RECOMMENDED OPERATING CONDITIONS**

SYMBOLS	PARAMETERS	UNITS	MIN	TYP	MAX
VCC	Supply Voltage <sup>1</sup>	V	2.7	3.0	3.3

Note:

1. Same voltage applied to pins 4 and 6

**TYPICAL PERFORMANCE CURVES** (Unless otherwise specified, TA = 25°C)

**CIRCUIT CURRENT vs. SUPPLY VOLTAGE**

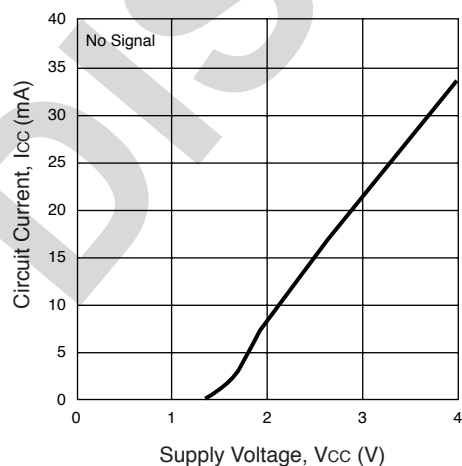

**CIRCUIT CURRENT vs. OPERATING AMBIENT TEMPERATURE**

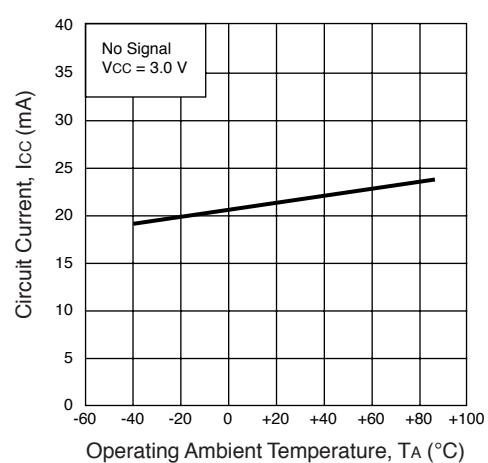

TYPICAL PERFORMANCE CURVES (Unless otherwise specified, TA = 25°C)

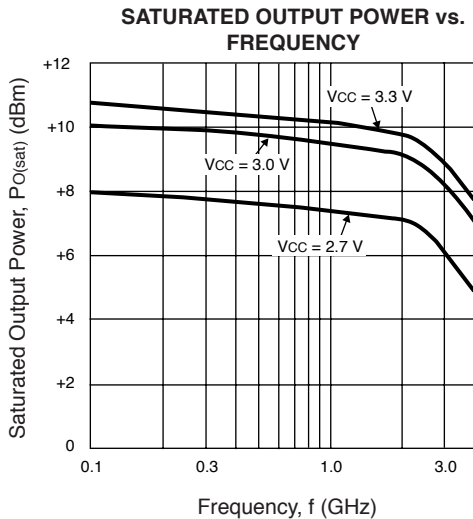
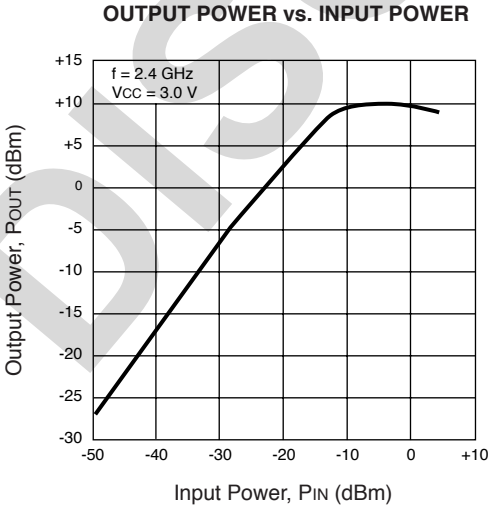
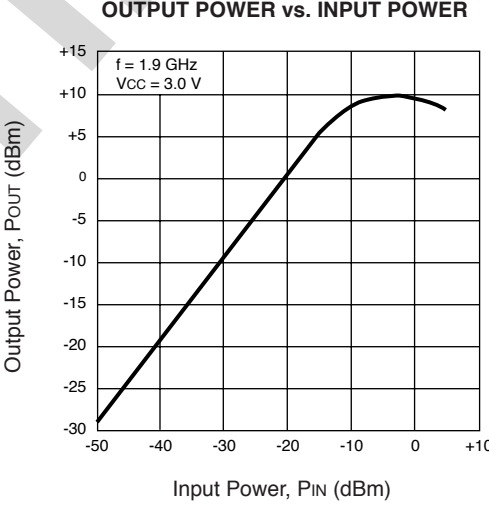
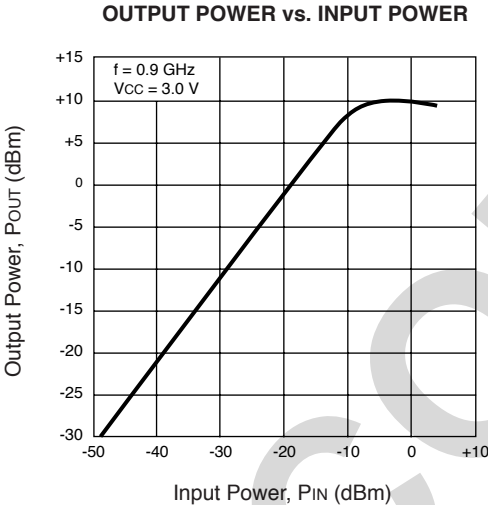
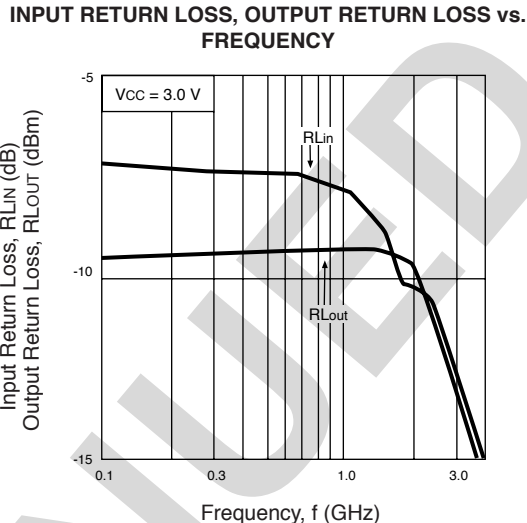
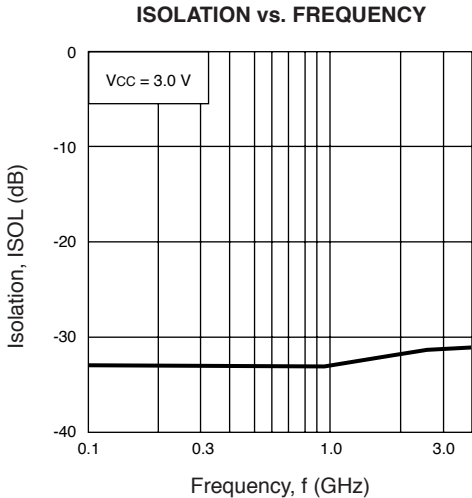

**TYPICAL PERFORMANCE CURVES** (Unless otherwise specified,  $T_A = 25^\circ\text{C}$ )

**THIRD ORDER INTERMODULATION DISTORTION vs. OUTPUT POWER OF EACH TONE**

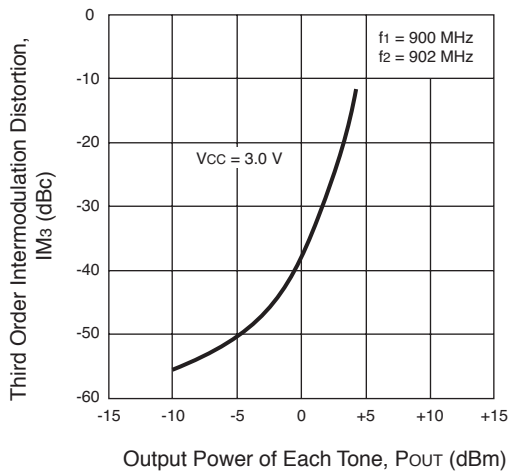

**THIRD ORDER INTERMODULATION DISTORTION vs. OUTPUT POWER OF EACH TONE**

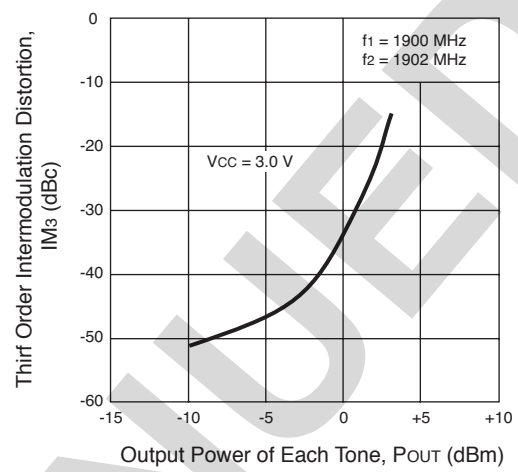

**THIRD ORDER INTERMODULATION DISTORTION vs. OUTPUT POWER OF EACH TONE**

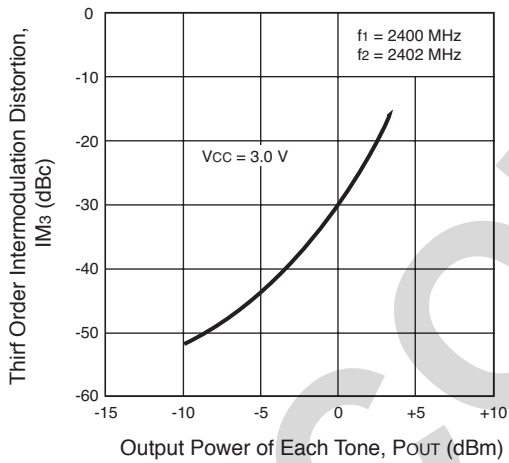

DISCONTINUED

**TYPICAL SCATTERING PARAMETERS** (TA = 25°C)

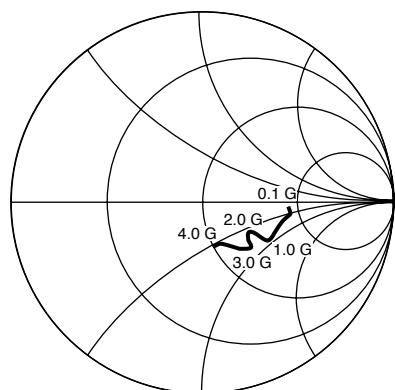

S11

Coordinates in Ohms  
Frequency in GHz  
Vcc = Vout = 3.0 V, Icc = 23

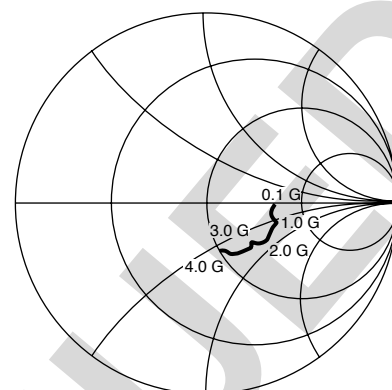

S22

Vcc = Vout = 3.0 V, Icc = 23.0 mA

FREQUENCY	S11		S21		S12		S22		K
GHz	MAG	ANG	MAG	ANG	MAG	ANG	MAG	ANG	
0.1	0.452	-2.7	9.078	-2.0	0.020	4.3	0.338	-1.6	1.89
0.2	0.467	-5.7	9.098	-4.9	0.021	4.2	0.346	-2.1	1.73
0.3	0.470	-7.5	9.143	-6.9	0.021	8.2	0.344	-1.0	1.72
0.4	0.460	-9.3	9.237	-10.1	0.021	9.8	0.335	-2.7	1.75
0.5	0.438	-11.5	9.284	-11.9	0.021	11.4	0.328	-4.8	1.84
0.6	0.415	-14.7	9.442	-14.6	0.022	8.1	0.337	-7.5	1.73
0.7	0.397	-18.6	9.670	-17.0	0.022	11.5	0.350	-7.9	1.72
0.8	0.395	-22.4	9.897	-19.7	0.022	16.3	0.354	-6.8	1.69
0.9	0.399	-25.6	10.166	-22.7	0.023	14.5	0.342	-6.0	1.56
1.0	0.404	-28.1	10.496	-26.0	0.022	13.4	0.331	-7.9	1.60
1.1	0.396	-29.0	10.903	-29.0	0.023	18.0	0.332	-10.8	1.48
1.2	0.394	-28.5	11.329	-32.8	0.025	16.6	0.353	-13.4	1.33
1.3	0.385	-28.0	11.895	-37.9	0.025	17.4	0.376	-14.3	1.26
1.4	0.368	-28.8	12.145	-42.4	0.024	22.0	0.374	-15.0	1.28
1.5	0.347	-29.5	12.356	-47.6	0.025	24.3	0.361	-16.3	1.28
1.6	0.335	-30.9	12.670	-51.8	0.026	20.6	0.356	-19.3	1.22
1.7	0.327	-31.5	12.966	-56.4	0.024	21.4	0.356	-22.0	1.29
1.8	0.328	-31.2	13.410	-61.4	0.026	23.2	0.366	-23.9	1.17
1.9	0.327	-29.4	13.722	-66.8	0.027	27.5	0.367	-25.6	1.11
2.0	0.325	-29.4	14.151	-72.3	0.026	24.6	0.369	-28.5	1.11
2.1	0.316	-28.5	14.412	-78.1	0.028	26.4	0.363	-31.7	1.05
2.2	0.295	-29.4	14.747	-84.1	0.027	26.5	0.361	-35.4	1.08
2.3	0.288	-30.8	15.144	-90.3	0.029	27.5	0.359	-37.1	1.02
2.4	0.291	-34.1	15.463	-97.4	0.029	27.1	0.346	-39.0	1.01
2.5	0.303	-38.3	15.264	-104.6	0.029	27.7	0.323	-40.6	1.04
2.6	0.317	-41.1	15.137	-112.6	0.028	25.5	0.303	-43.1	1.09
2.7	0.335	-41.3	14.774	-119.8	0.029	25.5	0.294	-43.9	1.07
2.8	0.349	-41.0	14.176	-127.7	0.031	25.0	0.299	-43.0	1.03
2.9	0.347	-39.4	13.710	-133.7	0.029	32.9	0.304	-41.3	1.09
3.0	0.345	-43.2	12.808	-139.8	0.029	24.8	0.317	-44.9	1.15
3.1	0.341	-45.4	12.313	-146.0	0.031	28.9	0.325	-46.7	1.13
3.2	0.331	-47.9	11.587	-149.3	0.029	31.6	0.318	-48.7	1.25
3.3	0.323	-49.8	11.003	-154.5	0.031	31.2	0.315	-52.1	1.27
3.4	0.311	-52.1	10.638	-157.7	0.031	29.5	0.307	-56.1	1.32
3.5	0.302	-52.6	10.228	-162.0	0.029	32.5	0.302	-60.0	1.44
3.6	0.289	-54.9	9.985	-166.5	0.030	31.4	0.303	-63.7	1.47
3.7	0.266	-56.5	9.543	-170.1	0.030	39.6	0.301	-65.1	1.54
3.8	0.253	-61.5	9.184	-174.5	0.031	34.1	0.294	-67.5	1.55
3.9	0.238	-65.6	8.816	-177.7	0.030	36.2	0.275	-68.8	1.71
4.0	0.238	-70.7	8.488	178.2	0.032	38.9	0.270	-71.0	1.70
4.1	0.244	-74.0	8.186	174.3	0.032	37.0	0.266	-75.1	1.75

# UPC8181TB

## PIN FUNCTIONS (Pin Voltage is measured at Vcc = 3.0 V)

Pin No.	Pin Name	Applied Voltage	Pin Voltage	Description	Equivalent Circuit
1	INPUT	—	0.99	Signal input pin. An internal matching circuit, configured with resistors, enables 50 Ω connection over a wide band. A multi-feedback circuit is designed to cancel the deviations of hFE and resistance. This pin must be coupled to signal source with capacitor for DC cut.	
2 3 5	GND	0	—	GND pin. This pin should be connected to the system ground with minimum inductance. Ground pattern on the board should be formed as wide as possible. All the ground pins must be connected together with wide ground pattern to decrease impedance difference.	
4	OUTPUT	Voltage as same as Vcc through external inductor	—	Signal output pin. The inductor must be attached between Vcc and output pins to supply current to the internal output transistors.	
6	Vcc	2.7 to 3.3	—	Power supply pin, which biases the internal input transistor. This pin should be externally equipped with bypass capacitor to minimize its impedance.	

## APPLICATION EXAMPLE (Digital Cellular Telephone)

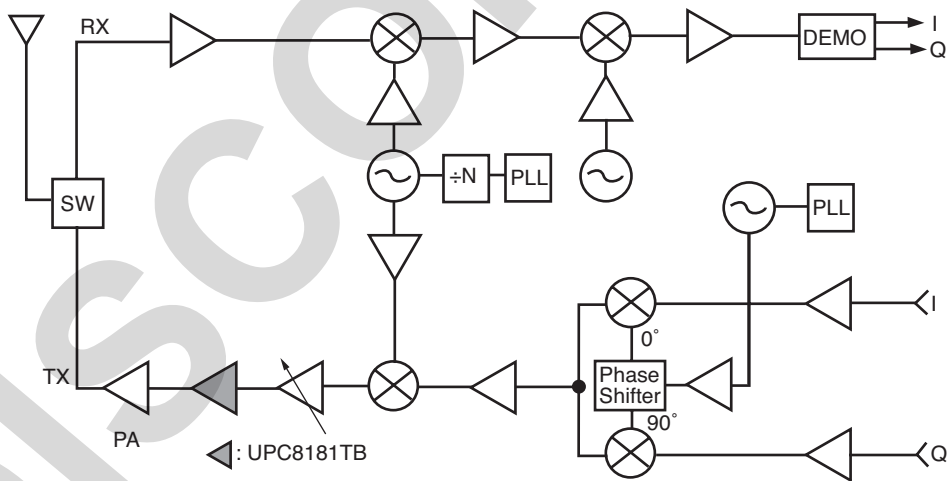

UPC8181TB

**OUTLINE DIMENSIONS** (Units in mm)

**6-PIN SUPER MINIMOLD**

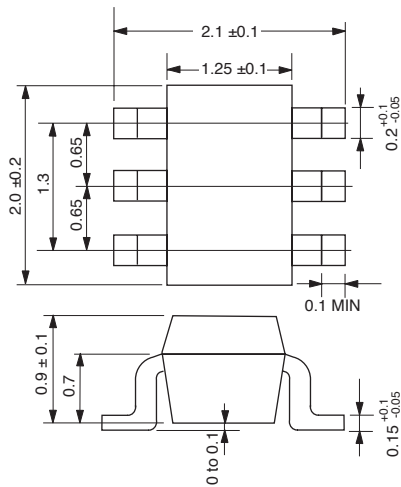

**LEAD CONNECTIONS**

(Top View)

(Bottom View)

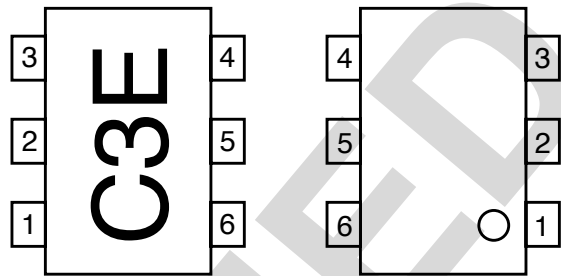

1. INPUT
2. GND
3. GND
4. OUTPUT
5. GND
6. Vcc

**ORDERING INFORMATION**

PART NUMBER	PACKAGE	QUANTITY
UPC8181TB-E3-A	6-pin super minimold	3kpcs/Reel

Note: Embossed tape 8 mm wide. Pins 1,2,3 face tape perforation side.

**TEST CIRCUIT**

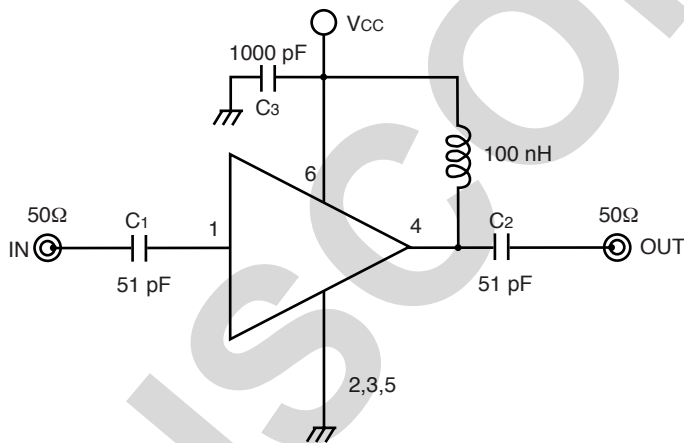

**APPLICATION BOARD**

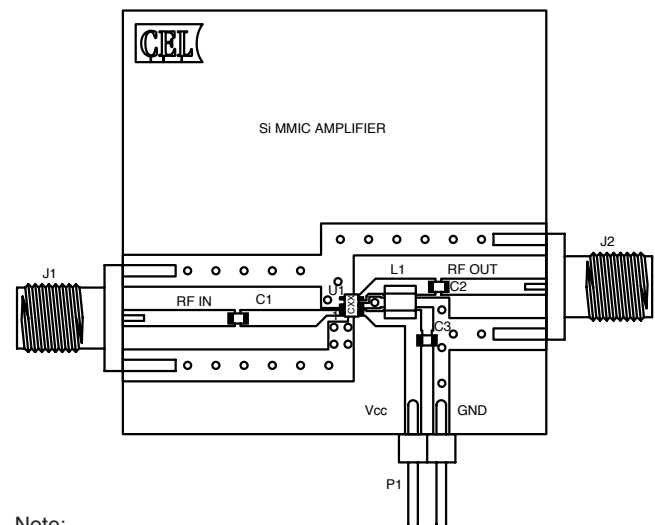

Note:

1. double sided copper clad GETEK board ( $H = .028$ ,  $\epsilon_r = 4.2$ .)
2. Back side: GND pattern.
3. Solder plated on patterns.
4. o O : Through holes.

EXCLUSIVE NORTH AMERICAN AGENT FOR RF, MICROWAVE & OPTOELECTRONIC SEMICONDUCTORS

**CEL CALIFORNIA EASTERN LABORATORIES** • Headquarters • 4590 Patrick Henry Drive • Santa Clara, CA 95054-1817 • (408) 988-3500 • Telex 34-6393 • FAX (408) 988-0279  
 DATA SUBJECT TO CHANGE WITHOUT NOTICE

Internet: <http://WWW.CEL.COM>

02/15/2002