

BUD	PART NAME	PTH SERIES NEMA 4X PLASTIC BOX STANDARD ORIENTATION (HINGED ON LONG SIDE)	PART No.	PTH-22422 THRU PTH-22422-C	PTH-22512 THRU PTH-22512-C	REV. DATE	6-12-19

DRAWING FOR REFERENCE
 WE RESERVE THE RIGHT TO MAKE CHANGES TO OUR
 STANDARD PRODUCTS. PLEASE CONSULT WITH BUD INDUSTRIES
 PRIOR TO USING THIS DRAWING FOR DESIGN PURPOSE.

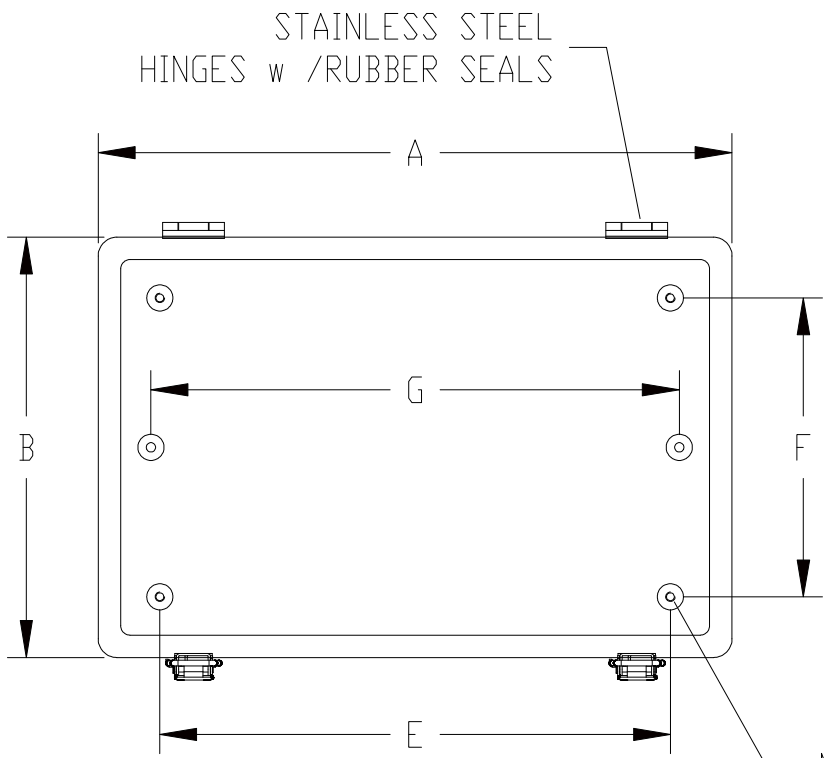

INSIDE VIEW OF BODY
COVER NOT SHOWN

NOTES:

- MATERIAL: BODY - GRAY POLYCARBONATE RESIN 10% GLASS FIBER FILLED
COVER - GRAY POLYCARBONATE OR CLEAR (-C SUFFIX) POLY-CARBONATE
- UL508 / NEMA TYPE 4X WITH IP-67 TUV RATING & UL-94 5VA
- CONTINUOUS Poured NEOPRENE GASKET IN COVER
- SUPPLIED WITH TWO OR FOUR M5 x 8mm LG. TRUSS HEAD ZINC PLATED STEEL SCREWS (ITEMS NOT SHOWN)
- DIMENSIONS ARE INCH [MM]
- OPTIONAL ACCESSORIES NOT INCLUDED:
INTERNAL MOUNTING PLATES 16 GA STEEL OR ABS
EXTERNAL MOUNTING BRACKETS NBX-10922 (STAINLESS STEEL) OR PIX-4117 (GRAY POLY-CARBONATE RESIN 10% GLASS FIBER FILLED)

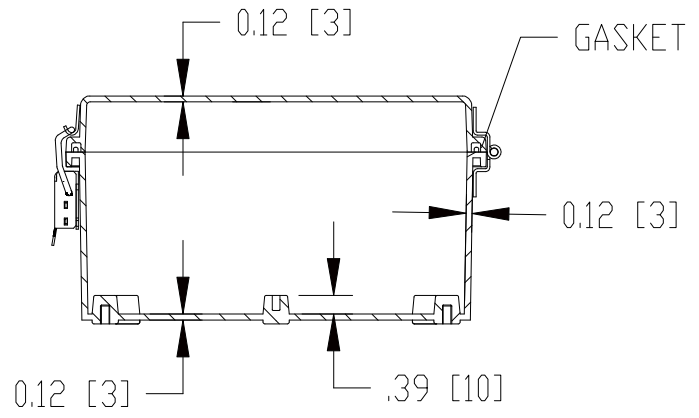
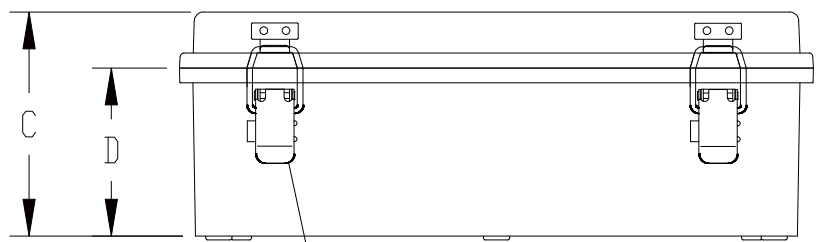

PART NO.		DIMENSIONS							LATCH QTY.
		A	B	C	D	E	F	G	
PTH-22422	PTH-22422-C	10.87 [276]	8.86 [225]	4.72 [120]	3.54 [90]	8.27 [210]	6.30 [160]	---	2
PTH-22426	PTH-22426-C	11.81 [300]	7.87 [200]	7.09 [180]	5.91 [150]	8.90 [226]	5.08 [129]	---	2
PTH-22428	PTH-22428-C	13.78 [350]	9.84 [250]	5.91 [150]	4.72 [120]	10.63 [270]	7.09 [180]	---	2
PTH-22430	PTH-22430-C	15.75 [400]	11.81 [300]	5.91 [150]	4.72 [120]	12.76 [324]	8.98 [228]	---	2
PTH-22432	PTH-22432-C	15.75 [400]	11.81 [300]	7.09 [180]	5.91 [150]	12.76 [324]	8.98 [228]	---	2
PTH-22436	PTH-22436-C	17.72 [450]	13.78 [350]	7.87 [200]	6.69 [170]	14.33 [364]	10.79 [274]	---	2
PTH-22438	PTH-22438-C	19.76 [502]	15.83 [402]	7.99 [203]	6.69 [170]	16.85 [428]	12.91 [328]	---	2
PTH-22440	PTH-22440-C	23.70 [602]	15.83 [402]	9.21 [234]	7.87 [200]	20.67 [525]	12.91 [328]	---	3
PTH-22442	PTH-22442-C	7.48 [190]	7.48 [190]	5.04 [128]	3.86 [98]	4.78 [121]	4.78 [121]	---	1
PTH-22446	PTH-22446-C	11.02 [280]	7.48 [190]	7.09 [180]	5.91 [150]	8.25 [209]	4.75 [121]	---	2
PTH-22448	PTH-22448-C	14.96 [380]	7.48 [190]	5.04 [128]	3.86 [98]	4.72 [120]	12.20 [310]	---	2
PTH-22450	PTH-22450-C	14.96 [380]	7.48 [190]	7.09 [180]	5.91 [150]	12.19 [309]	4.72 [120]	---	2
PTH-22456	PTH-22456-C	14.96 [380]	11.02 [280]	7.01 [178]	5.83 [148]	12.24 [311]	8.27 [210]	---	2
PTH-22458	PTH-22458-C	22.05 [560]	11.02 [280]	5.12 [130]	3.94 [100]	19.29 [490]	8.27 [210]	---	3
PTH-22460	PTH-22460-C	16.93 [430]	13.00 [330]	7.09 [180]	5.91 [150]	14.17 [360]	10.22 [260]	14.75 [375]	2
PTH-22462	PTH-22462-C	22.05 [560]	14.96 [380]	7.01 [178]	5.83 [148]	19.29 [490]	12.20 [310]	---	2
PTH-22480	PTH-22480-C	9.84 [250]	3.15 [80]	3.35 [85]	1.97 [50]	7.87 [200]	1.59 [40]	8.65 [220]	2
PTH-22490	PTH-22490-C	6.70 [170]	5.51 [140]	3.74 [95]	2.95 [75]	4.54 [115]	1.97 [50]	5.12 [130]	2
PTH-22492	PTH-22492-C	9.06 [230]	5.51 [140]	3.74 [95]	2.95 [75]	6.90 [175]	3.94 [100]	7.50 [190]	2
PTH-22496	PTH-22496-C	7.87 [200]	5.91 [150]	2.95 [75]	2.17 [55]	---	---	6.30 [160]	2
PTH-22498	PTH-22498-C	7.87 [200]	5.91 [150]	3.94 [100]	3.15 [80]	---	---	6.30 [160]	2
PTH-22502	PTH-22502-C	7.87 [200]	5.91 [150]	6.30 [160]	4.33 [110]	---	---	6.30 [160]	2
PTH-22506	PTH-22506-C	9.84 [250]	5.91 [150]	5.12 [130]	3.15 [80]	---	---	8.27 [210]	2
PTH-22510	PTH-22510-C	7.87 [200]	7.87 [200]	6.30 [160]	5.51 [140]	5.91 [150]	4.75 [121]	6.30 [160]	2
PTH-22512	PTH-22512-C	9.06 [230]	8.27 [210]	3.94 [100]	3.15 [80]	7.09 [180]	6.30 [160]	7.09 [180]	1