

MGA-13516

High Gain, High Linearity, Active Bias,
Low Noise Amplifier



Data Sheet

Description

Avago Technologies' MGA-13516 is a two stage, easy-to-use GaAs MMIC Low Noise Amplifier (LNA) with active bias. The LNA has low noise with good input return loss and high linearity achieved through the use of Avago Technologies' proprietary 0.5um and 0.25um GaAs Enhancement-mode pHEMT process. Both LNAs inside have extra feature that allows a designer to adjust supply current. The first stage has an additional feature where the gain can be adjusted externally without affecting noise figure. Minimum matching needed for input, output and the inter-stage between the two LNA.

It is designed for optimum use between 400MHz to 1.5GHz. For optimum performance at higher frequency from 1.4GHz to 2.7GHz, the MGA-14516 is recommended. Both MGA-13516 & MGA-14516 share the same package and pinout.

Pin Configuration and Package Marking

4.0 x 4.0 x 0.85 mm³ 16-lead QFN

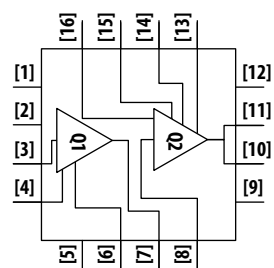
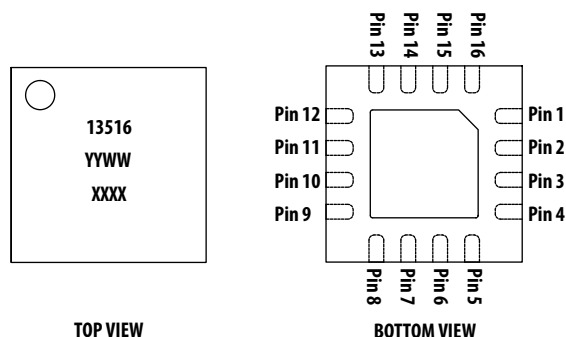

Pin	Description	Pin	Description
1	Not Used	9	Not Used
2	Gnd	10	RFout
3	RFin	11	RFout
4	RFgnd1	12	Not Used
5	Vbias1	13	Vg
6	FB1	14	RFgnd2
7	RFout1	15	Vm
8	RFin2	16	Vbias

Features

- Low noise figure
- High gain
- Good IRL
- High linearity performance
- High reverse isolation
- Externally adjustable supply current
- Externally adjustable gain
- GaAs E-pHEMT Technology [1]
- Low cost QFN package
- Excellent uniformity in product specifications

Specifications

900MHz ; Q1 : 5V, 45mA (typ) Q2 : 5V, 110mA

- 31.8 dB Gain
- 0.66 dB Noise Figure
- 13 dB IRL
- 38 dBm Output IP3
- 23.5 dBm Output Power at 1dB gain compression

Applications

- Low noise amplifier for cellular infrastructure including GSM, CDMA and W-CDMA.
- Other very low noise applications.

Note:

1. Enhancement mode technology employs positive Vgs, thereby eliminating the need of negative gate voltage associated with conventional depletion mode devices.



Attention: Observe precautions for handling electrostatic sensitive devices
 ESD Machine Model = 40 V
 ESD Human Body Model = 200 V
 Refer to Avago Application Note A004R: *Electrostatic Discharge, Damage and Control.*

Notes:

Package marking provides orientation and identification "13516" is the Product Identification, "YYWW" is the Date Code, "XXXX" is the last 4 digits of the lot number.

MGA-13516 Absolute Maximum Rating [1]

Symbol	Parameter	Units	Absolute Max.
Vdd1	Device Supply Voltage	V	5.5
Vbias1	Control Voltage	V	3.5
Vdd2	Device Voltage, RF output to ground	V	6
Vbias	Control Voltage	V	6
Idd2	Device Drain Current	mA	150
P _{in,max}	CW RF Input Power (Vdd1 = 5.0V, Idd1=45mA)	dBm	20
P _{diss}	Total Power Dissipation [3]	W	1.30
T _j	Junction Temperature	°C	150
T _{STG}	Storage Temperature	°C	-65 to 150

Thermal Resistance [1-3] (V_{dd1}=V_{dd2}=V_{bias}=5V), $\theta_{jc} = 36 \text{ }^\circ\text{C/W}$

Notes:

1. Operation of this device in excess of any of these limits may cause permanent damage.
2. Thermal resistance measured using Infra-Red Microscopy Technique.
3. Board temperature T_B is 25 °C. Derate 28mW/°C for T_B>120 °C.

Product Consistency Distribution Charts[4]

T_A = 25 °C, 900MHz, Vdd1=5V, Vdd2=5V, Vbias=5V, F_{RF}=900MHz, unless stated otherwise.

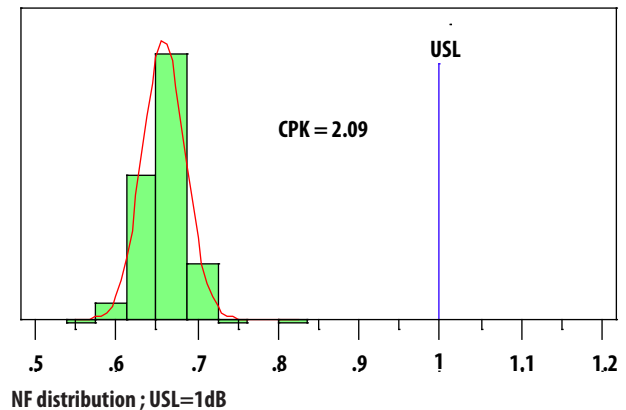
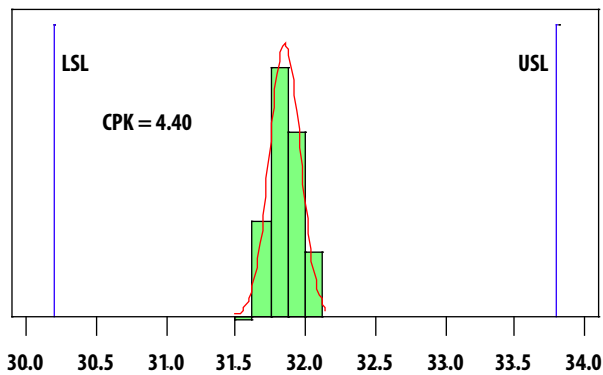
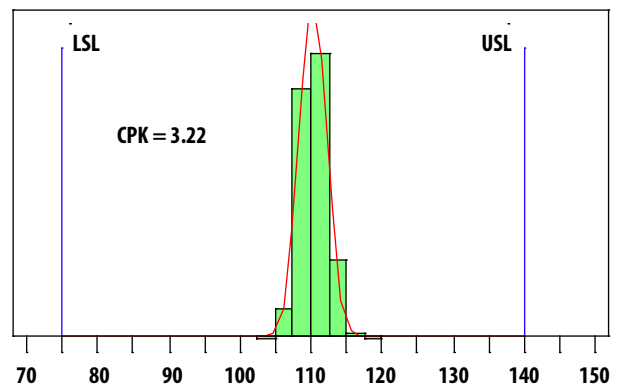
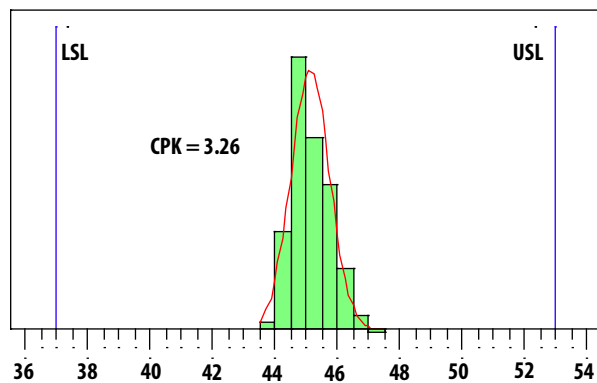

Notes::

4. Distribution data sample size is 500 samples taken from 3 different wafer lots. Future wafer allocated to this product may have nominal values anywhere between the upper and lower limits. Circuit losses have not been de-embedded from actual measurements.

Demo Board Layout

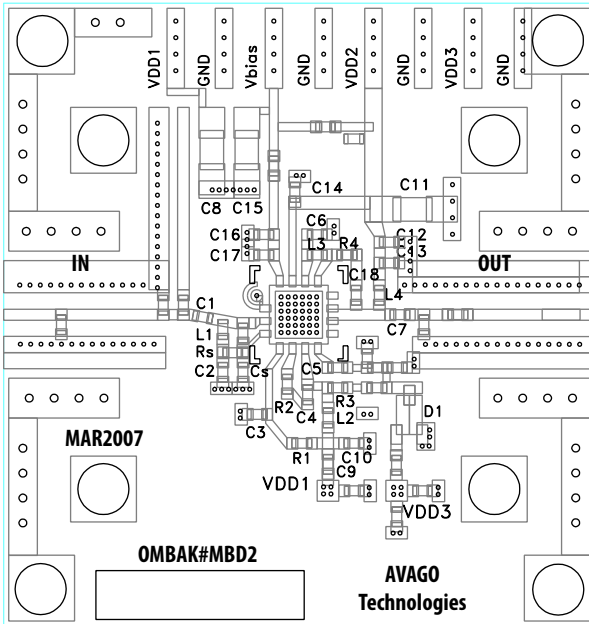

Notes:

- Recommended PCB material is 10 mils Rogers RO4350.
- Suggested component values may vary according to layout and PCB material.
- L1 and C1 form the input matching network.
- L4 and C7 form the output matching network.
- L2, L3, C5 form the inter-stage matching network.
- R2 and C4 form the network for externally gain adjustment feature. (optional)
- R4 and C18 form the network for externally gain adjustment feature. (optional)
- Cs, C6, C13 are RF bypass capacitor.
- C16 mitigates the effect of external noise pickup on the Vbias line.
- R1 is bias resistor for Q1.

Figure 5. Demo Board Layout

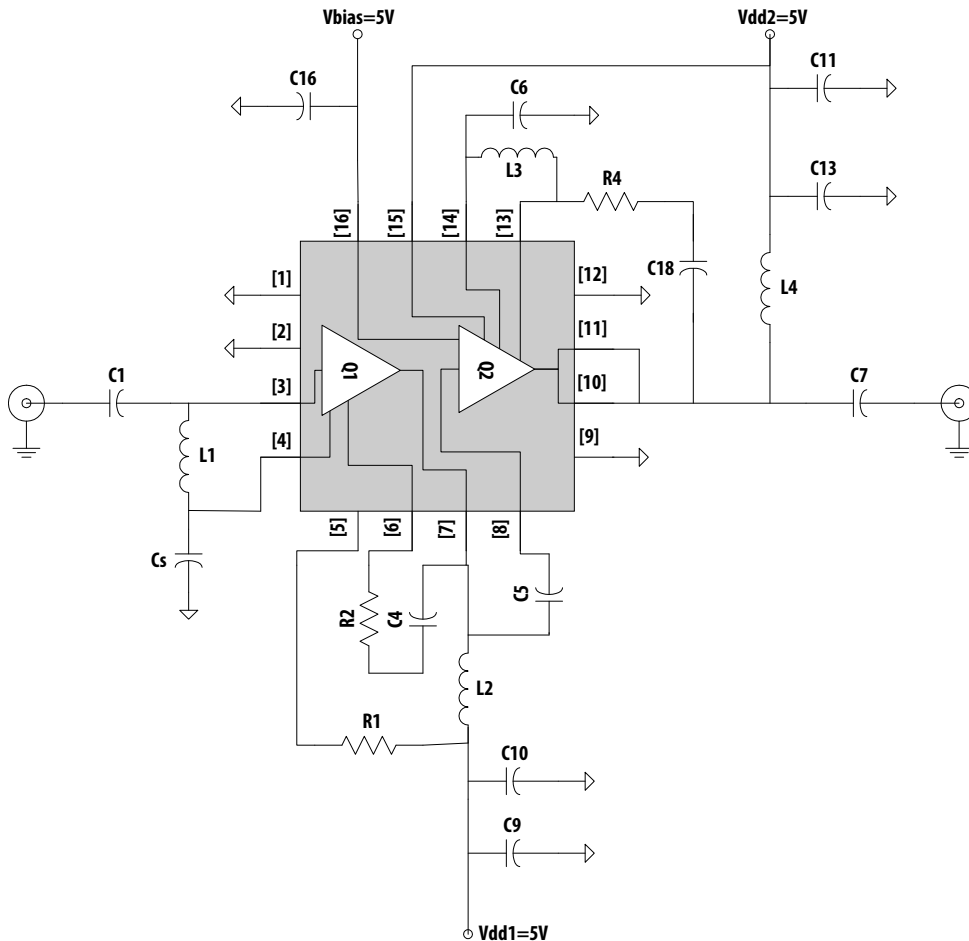

Figure 6. Demo Board Schematic

Table 1. 900MHz Matching Components

Demo board (shown in Figure 5) component values used for demo board schematic shown in Figure 6. These component values are used when measuring Electrical Specifications and plots of Figure 7 to Figure 15.

Part	Size	Value	Description
Cs	0402	33pF	Rohm MCH155A330JK
C1	0402	4.3pF	Rohm MCH155A4R3CK
C4	0402	33pF	Rohm MCH155A330JK
C5	0402	2.4pF	Kyocera CM05CH240J50AHF
C6	0402	33pF	Rohm MCH155A330JK
C7	0402	11pF	Rohm MCH155A110JK
C10	0402	100pF	Kyocera CM05CH101J50AHF
C13	0402	33pF	Rohm MCH155A330JK
C16	0402	33pF	Rohm MCH155A330JK
C18	0402	33pF	Rohm MCH155A330JK
L1	0402	11nH	Coilcraft 0402CS11NXJBW
L2	0402	3.9nH	Toko LL1005-FHL3N9S
L3	0402	100nH	Toko LL1005-FHLR10J
L4	0402	18nH	Toko LL1005-FHL18NJ
R1	0402	1.8kohm	Rohm MCR01MZSJ182
R2	0402	82ohm	Rohm MCR01MZSJ820
R4	0402	680ohm	Rohm MCR01MZSJ681

Electrical Specifications [5, 6]

$T_A = 25^\circ\text{C}$, $V_{dd1}=5\text{V}$, $V_{dd2}=5\text{V}$, $V_{bias}=5\text{V}$, $F_{RF}=900\text{MHz}$, unless stated otherwise.

Symbol	Parameter and Test Condition	Units	Min.	Typ.	Max.
I _{dd1}	Current at Q1	mA	37	45	53
I _{dd2}	Current at Q2	mA	75	110	140
I _{bias}	Bias Current for Q2	mA		5	
Gain	Associated Gain	dB	30.2	31.8	33.8
NF	Noise Figure	dB		0.66	1.0
OIP3	Output Third Order Intercept Point (2-tone @ $F_{RF} \pm 1\text{MHz}$, $P_{in} = -25\text{dBm}$)	dBm		38	
OP1dB	Output Power at 1dB Gain Compression	dBm		23.5	
IRL	Input Return Loss	dB		13	
ORL	Output Return Loss	dB		15	
S12	Reverse Isolation	dB		-50	

Notes:

- Measurements obtained using demo board described in Figure 5 with component list in Table 1. Input and Output trace loss is not de-embedded from the measurement.
- Guaranteed specifications are 100% tested in production test circuit.

MGA-13516 Typical Performance

$T_A = 25^\circ\text{C}$, $V_{dd1}=5\text{V}$, $V_{dd2}=5\text{V}$, $V_{bias}=5\text{V}$ unless stated otherwise. Measured on demo board in Fig. 5 with component list in Table 1 for 900MHz matching.

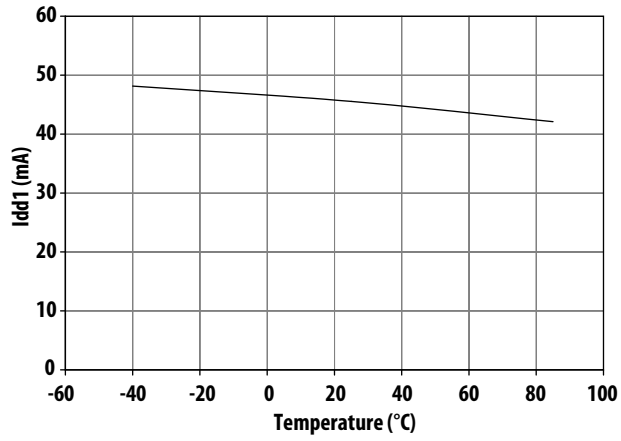

Figure 7. I_{dd1} vs. Temperature

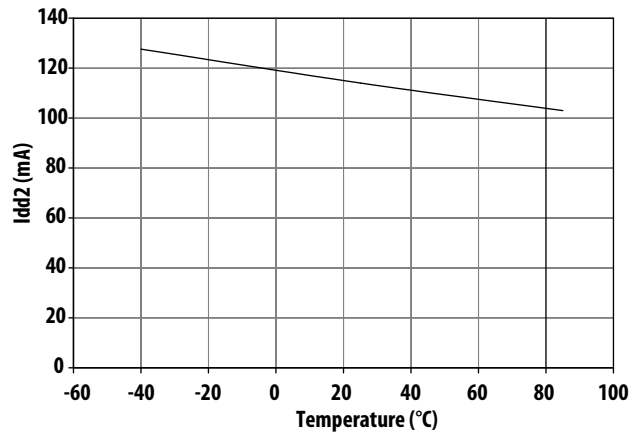

Figure 8. I_{dd2} vs. Temperature

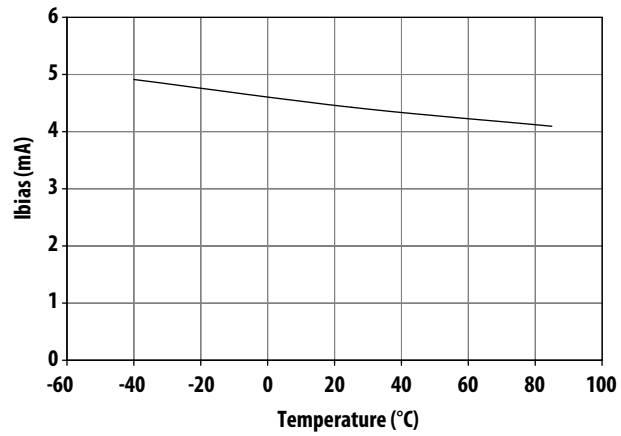

Figure 9. I_{bias} vs. Temperature

MGA-13516 Typical Performance

$T_A = 25^\circ\text{C}$, $V_{dd1}=5\text{V}$, $V_{dd2}=5\text{V}$, $V_{bias}=5\text{V}$ unless stated otherwise. Measured on demo board in Fig. 5 with component list in Table 1 for 900MHz matching.

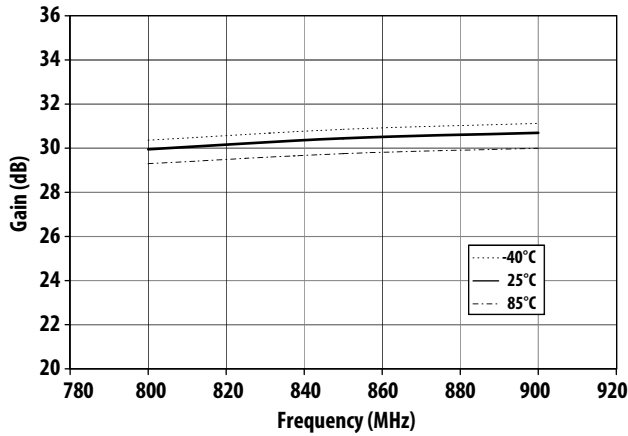

Figure 10. Gain vs. Frequency and Temperature

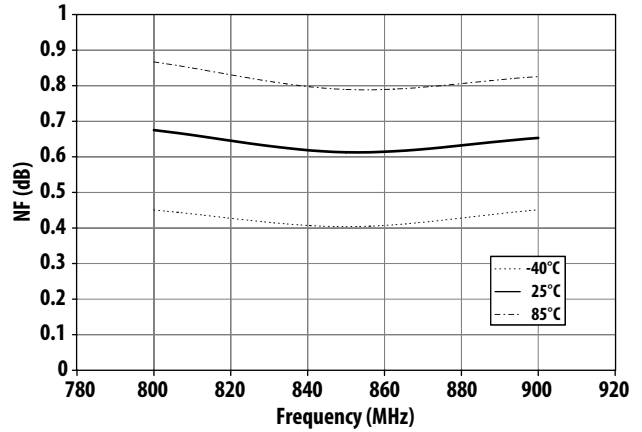

Figure 11. NF vs. Frequency and Temperature

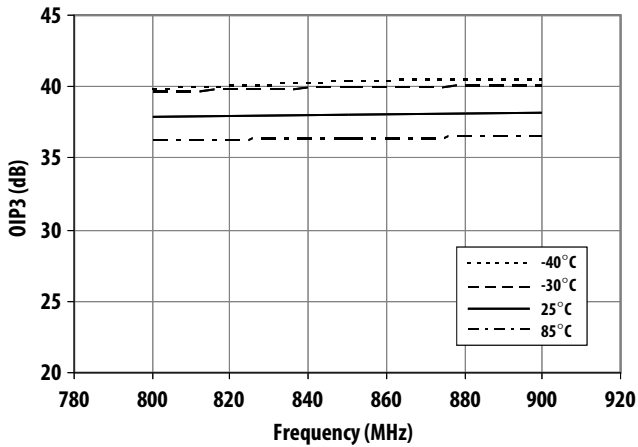

Figure 12. OIP3 vs. Frequency and Temperature

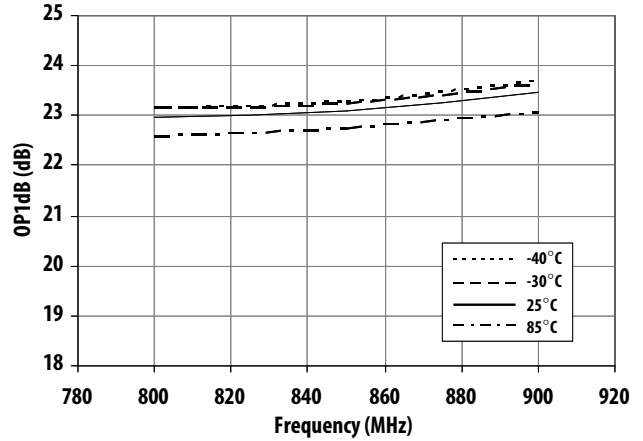

Figure 13. OP1dB vs. Frequency and Temperature

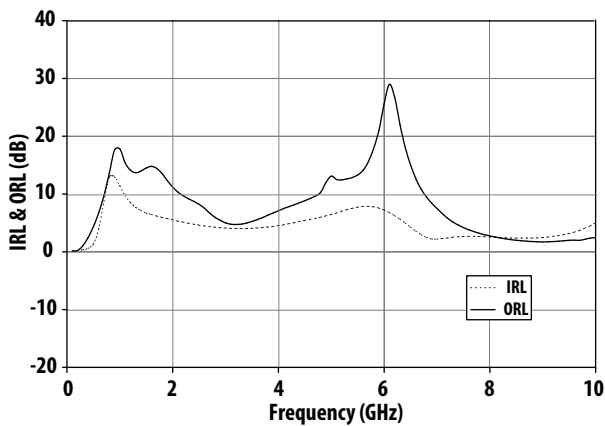

Figure 14. IRL & ORL vs. Frequency

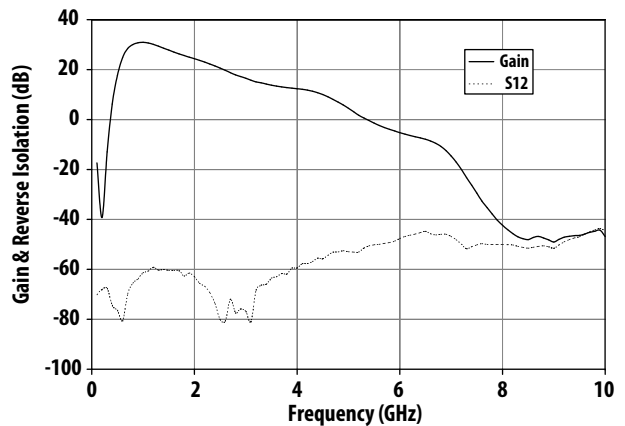
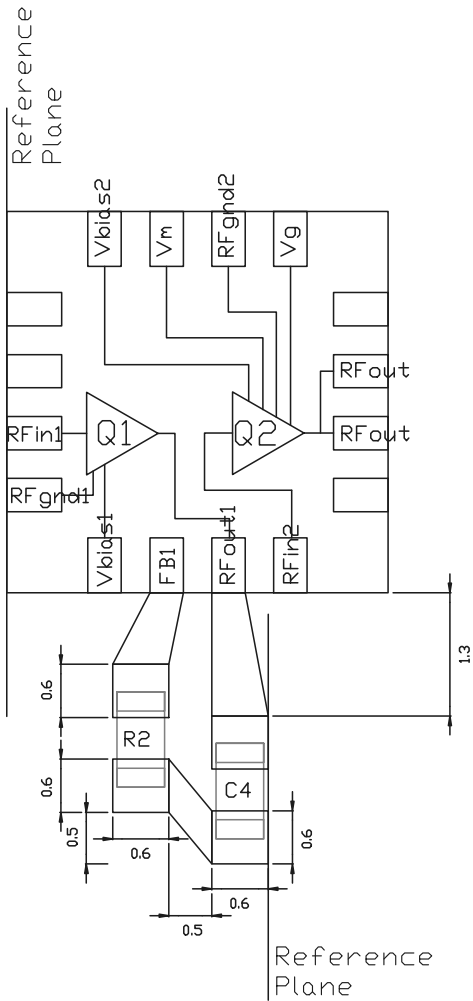

Figure 15. Gain & S12 vs. Frequency

MGA-13516 Scattering Parameter and Noise Parameter Test Setup



Note: All dimensions are in millimeters.
PCB material is 10 mils Rogers RD4350.

Figure 16. Test setup for Q1 S & Noise Parameters data. R2=82ohm (Rohm MCR01MZSJ820) and C4=33pF (Rohm MCH155A330JK).

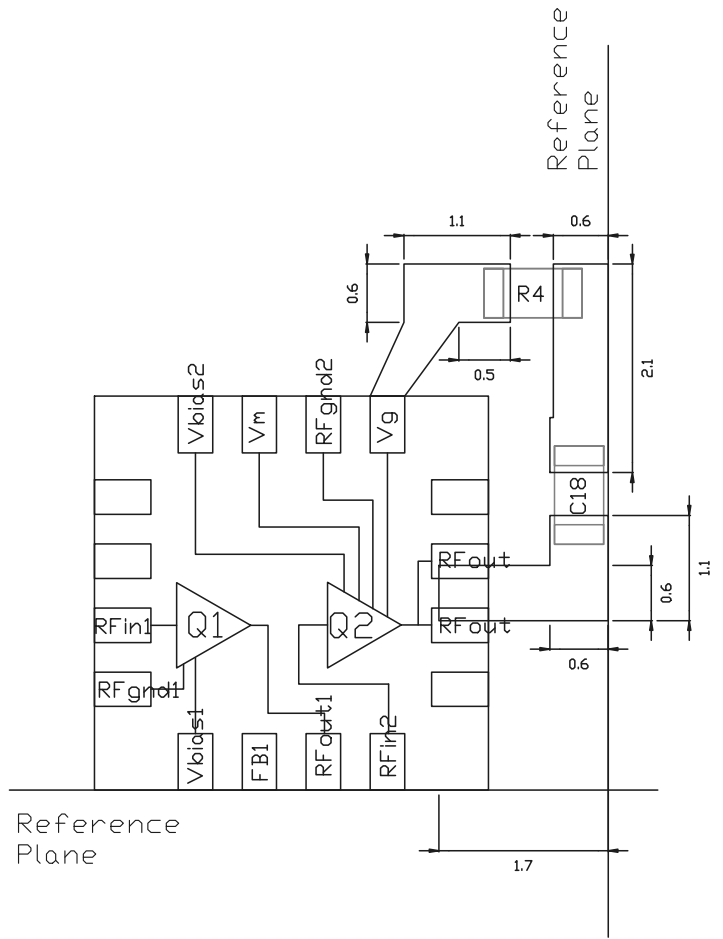

Note: All dimensions are in millimeters.
PCB material is 10 mils Rogers RD4350.

Figure 17. Test setup for Q2 S & Noise Parameters data. C18=33pF (Rohm MCH155A330JK) and R4=680Ω (Rohm MCR01MZSJ681).

MGA-13516 Q1 Typical Scattering Parameters, Vdd1=5V, Idd1=45mA

Freq (GHz)	S11		S21		S12		S22	
	Mag	Ang	Mag	Ang	Mag	Ang	Mag	Ang
0.1	0.94	-12.3	21.09	152.4	0.005	61.3	0.48	-39.9
0.5	0.61	-23.5	9.89	120.4	0.013	26.6	0.16	-69.9
0.9	0.53	-23.3	6.68	106.1	0.014	12.8	0.16	-64.8
1	0.53	-22.9	6.19	103.6	0.014	11	0.16	-64.6
1.5	0.52	-26.5	4.46	92.8	0.014	1.6	0.23	-67.1
1.9	0.51	-29.3	3.6	86.5	0.013	-1.5	0.29	-69.3
2	0.52	-30.1	3.44	85.2	0.013	-1.7	0.3	-69.7
2.5	0.53	-32.7	2.87	78.8	0.011	-1.8	0.36	-69.9
3	0.55	-33.3	2.56	73.5	0.011	-1.1	0.39	-70
3.5	0.55	-31.8	2.34	67.5	0.009	3.9	0.37	-75.1
4	0.55	-30.1	2.25	59.8	0.008	11.1	0.35	-90
5	0.47	-32.4	2.1	38.8	0.009	50.1	0.41	-140
6	0.4	-68.8	1.9	14.6	0.021	74.3	0.53	-162.5
7	0.63	-109	1.74	-20.8	0.056	49.2	0.29	156.3
8	0.75	-117.1	0.72	-65.8	0.085	20.6	0.58	15.7
9	0.75	-102.6	0.34	-58.8	0.058	-16.5	0.82	24.9
10	0.56	-105.5	0.37	-56.7	0.108	-38	0.65	35.8

Note: S-parameters are measured on PCB. The PCB material is 10 mils Rogers RO4350. Figure 16 shows the input and output reference planes.

MGA-13516 Q1 Typical Noise Parameter, Vdd1=5V, Idd1=45mA

Freq (GHz)	Fmin(dB)	Γ_{opt}		Rn/50
		mag	ang.	
0.8	0.37	0.49	35.52	0.09
0.9	0.39	0.47	41.64	0.10
1.0	0.38	0.46	46.11	0.11
1.5	0.68	0.38	57.89	0.15
1.7	0.78	0.35	61.08	0.17

Note: Noise parameters are measured on PCB. The PCB material is 10 mils Rogers RO4350. Figure 16 shows the input and output reference planes.

MGA-13516 Q2 Typical Scattering Parameters, Vdd2=5V, Vbias=5V, IDD2=110mA

Freq (GHz)	S11		S21		S12		S22	
	Mag	Ang	Mag	Ang	Mag	Ang	Mag	Ang
0.1	0.12	-37.7	11.19	165.1	0.038	0.3	0.35	-179
0.5	0.13	-128.1	8.61	126.9	0.037	-0.7	0.31	176.4
0.9	0.18	175.2	6.57	99.9	0.04	-1.8	0.27	179.3
1	0.18	165.2	6.23	94.4	0.041	-2.2	0.26	-180
1.5	0.19	126.8	5.13	69.4	0.05	-10.7	0.2	-161.7
1.9	0.13	84.4	4.69	48.3	0.056	-24.4	0.2	-131.8
2	0.12	65.9	4.62	42.5	0.058	-29.4	0.22	-125.2
2.5	0.2	-52.9	4.19	8.8	0.062	-61.5	0.33	-115.5
3	0.42	-104.3	3.39	-28.3	0.05	-103.6	0.3	-123.1
3.5	0.55	-140.7	2.31	-62.3	0.029	-140.5	0.27	-100.4
4	0.6	-170.9	1.5	-89.8	0.02	-166.3	0.36	-112.5
5	0.68	141.8	0.65	-132.1	0.021	125.6	0.3	-156.7
6	0.7	107.4	0.33	-167.5	0.026	80.7	0.2	-173.7
7	0.65	35.5	0.18	139	0.025	29.5	0.13	-61.4
8	0.85	-33.2	0.04	85.7	0.007	-48.3	0.49	-38.1
9	0.69	-21.5	0.02	93.3	0.013	94.9	0.69	-24.1
10	0.51	28	0.02	157.1	0.021	160	0.73	-4.8

Note: S-parameters are measured on PCB. The PCB material is 10 mils Rogers RO4350. Figure 17 shows the input and output reference planes.

MGA-13516 Q2 Typical Noise Parameter, Vdd2=5V, Idd2=110mA

Freq (GHz)	Fmin(dB)	Γ_{opt}		Rn/50
		mag	ang.	
0.8	2.01	0.29	8.11	0.29
0.9	2.22	0.31	12.80	0.30
1.0	2.32	0.26	15.20	0.26
1.5	2.75	0.18	35.27	0.24
1.7	2.95	0.15	68.10	0.32

Note: Noise parameters are measured on PCB. The PCB material is 10 mils Rogers RO4350. Figure 17 shows the input and output reference planes.

Part Number Ordering Information

Part Number	No. of Devices	Container
MGA-13516-TR1G	1000	7" Reel
MGA-13516-TR2G	3000	13" Reel
MGA-13516-BLKG	100	antistatic bag

SLP4X4 Package Dimension

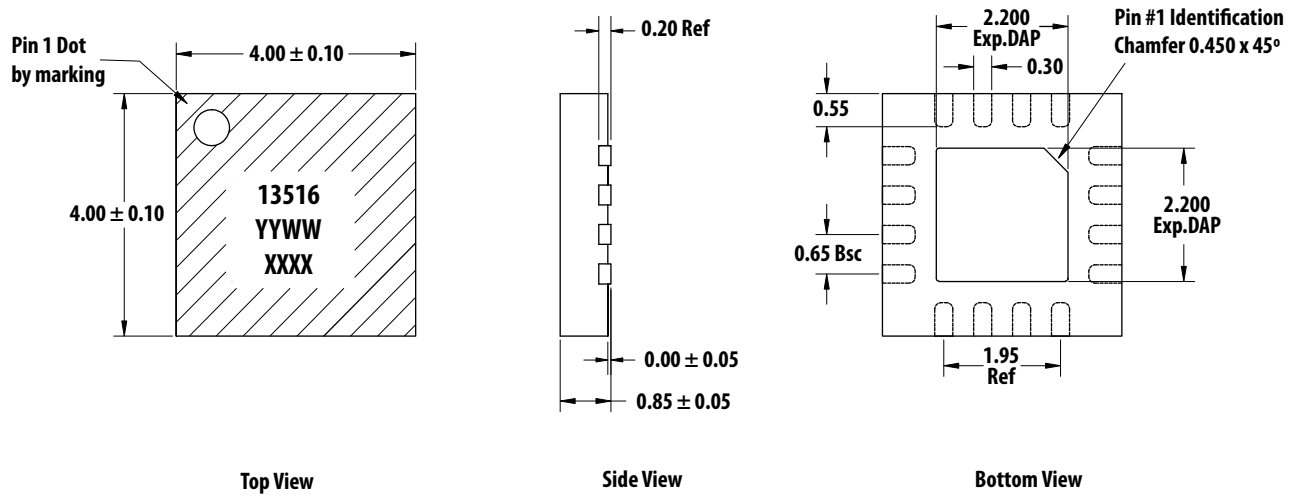

Notes:

1. All dimensions are in millimeters.
2. Dimensions are inclusive of plating.
3. Dimensions are exclusive of mold ash and metal burr.

PCB Land Pattern and Stencil Design

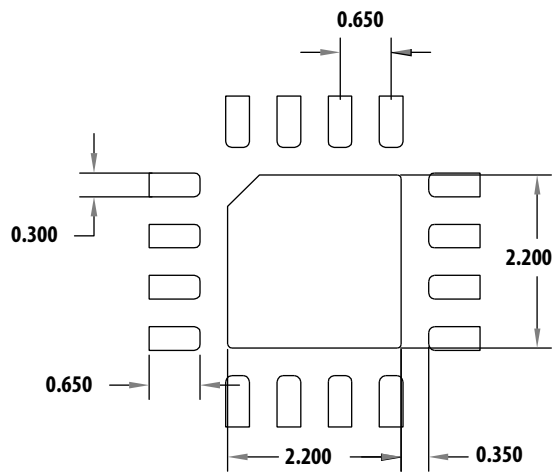

PCB Land Pattern (Top View)

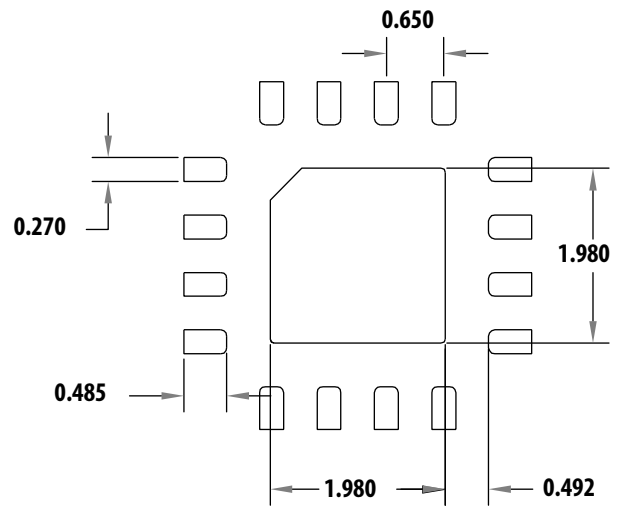

Stencil Outline

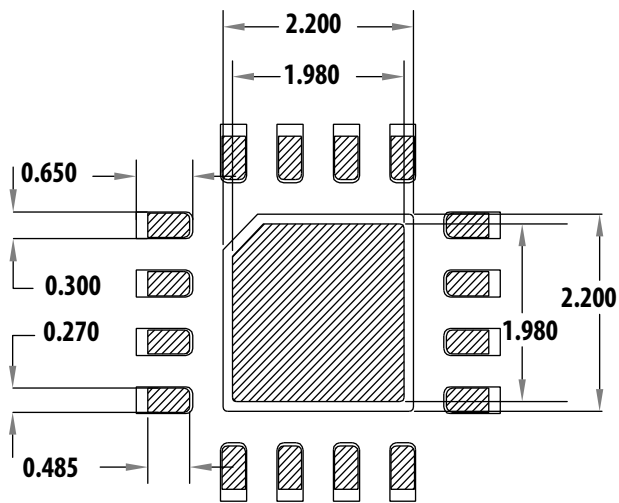

Combines PCB & Stencil Layouts
All Dimension are in millimeters

Device Orientation

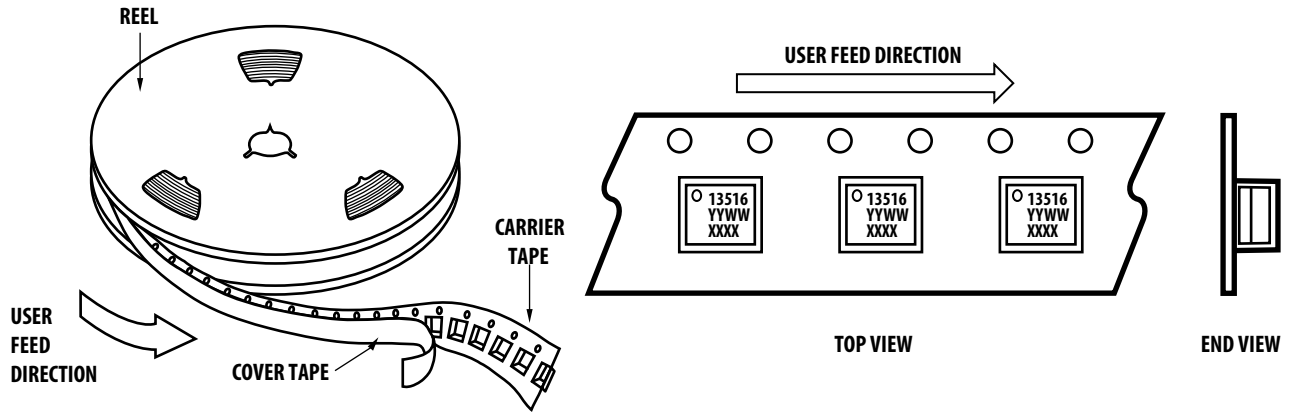

Tape Dimensions

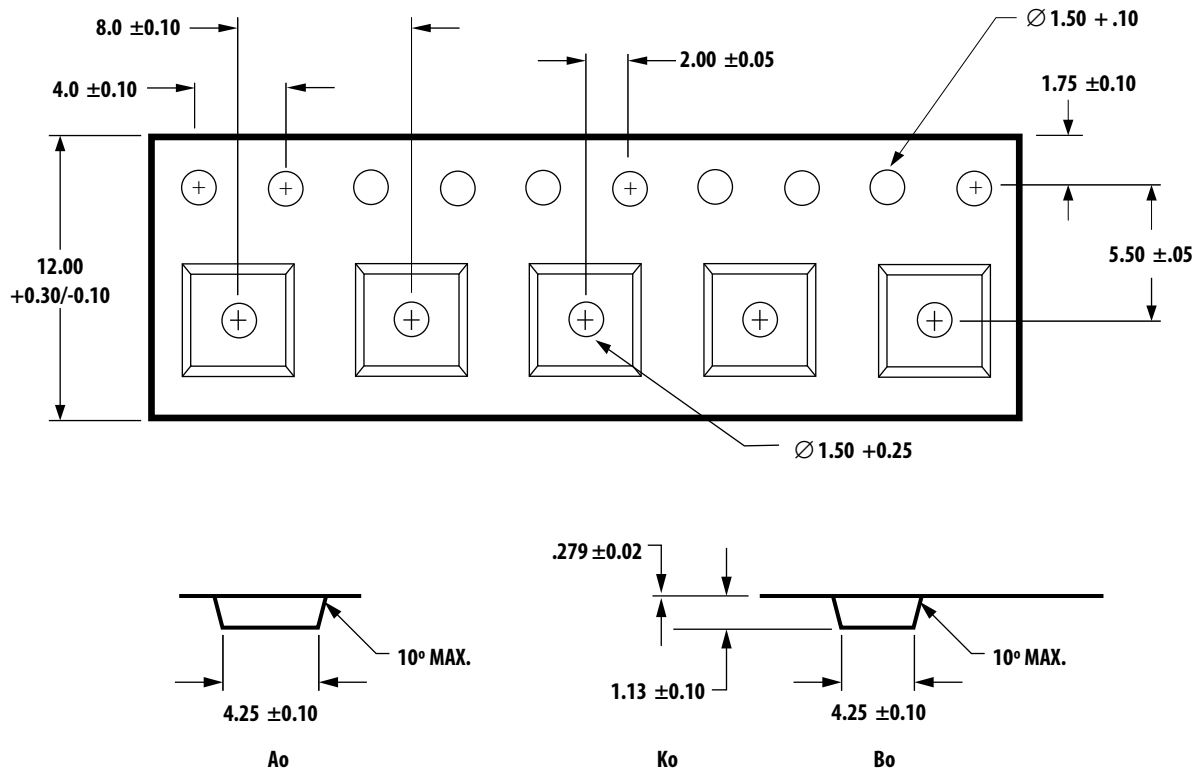

Reel Dimension - 7 Inch

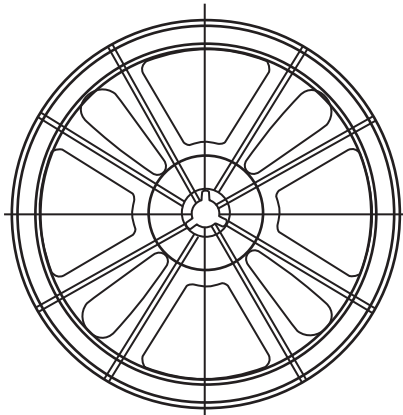

FRONT VIEW

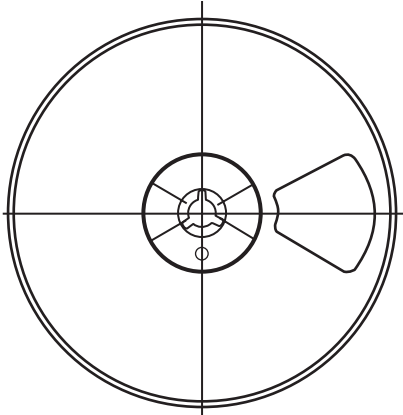

BACK VIEW

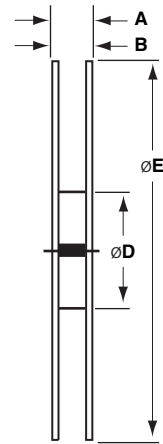

SIDE VIEW

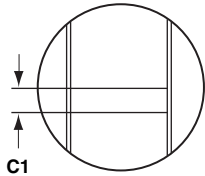

C1

TAPE SLOT
PLANE VIEW

SPECIFICATION								
TAPE WIDTH	A MAX	B +1.5-0.0	C1 ±0.5	∅D ±0.5	∅E (max)	F (min)	∅G ±0.2	∅H (min)
12mm	18.00	12.4	4.40	55.0	178	1.50	13.50	20.20

Note: Surface resistivity to be $<10^{12}$ Ohms/square

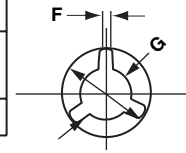

ARBOR HOLE

Reel Dimension - 13 Inch

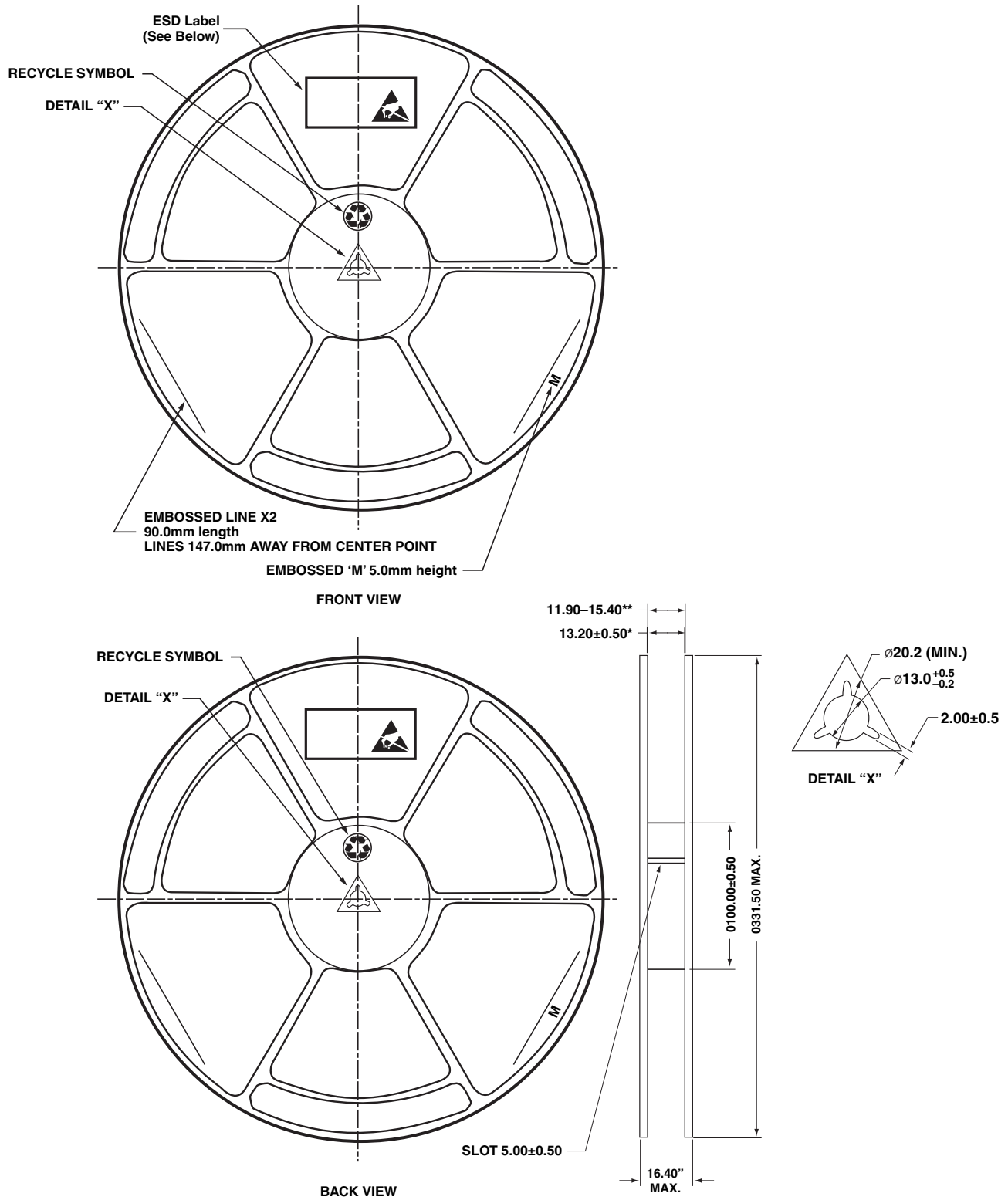

For product information and a complete list of distributors, please go to our web site: www.avagotech.com

Avago, Avago Technologies, and the A logo are trademarks of Avago Technologies in the United States and other countries. Data subject to change. Copyright © 2005-2008 Avago Technologies. All rights reserved. AV02-1048EN - July 3, 2008

