

HLMP-ELxx, HLMP-EHxx, HLMP-EJxx, HLMP-EGxx

T-1³/₄ (5 mm) Precision Optical Performance

AllnGaP LED Lamps



Data Sheet



Lead (Pb) Free
RoHS 6 fully
compliant



Description

These Precision Optical Performance AllnGaP LEDs provide superior light output for excellent readability in sunlight and are extremely reliable. AllnGaP LED technology provides extremely stable light output over long periods of time. Precision Optical Performance lamps utilize the aluminum indium gallium phosphide (AllnGaP) technology.

These LED lamps are untinted, nondiffused, T-1³/₄ packages incorporating second generation optics producing well defined spatial radiation patterns at specific viewing cone angles.

These lamps are made with an advanced optical grade epoxy, offering superior high temperature and high moisture resistance performance in outdoor signal and sign applications. The high maximum LED junction temperature limit of +130°C enables high temperature operation in bright sunlight conditions. The package epoxy contains both uv-a and uv-b inhibitors to reduce the effects of long term exposure to direct sunlight.

These lamps are available in two package options to give the designer flexibility with device mounting.

Benefits

- Viewing angles match traffic management sign requirements
- Colors meet automotive and pedestrian signal specifications
- Superior performance in outdoor environments
- Suitable for autoinsertion onto PC boards

Features

- Well defined spatial radiation patterns
- Viewing angles: 8°, 15°, 23°, 30°
- High luminous output
- Colors:
 - 590 nm amber
 - 605 nm orange
 - 615 nm reddish-orange
 - 626 nm red
- High operating temperature: $T_{JLED} = +130^{\circ}\text{C}$
- Superior resistance to moisture
- Package options:
 - With or without lead stand-offs

Applications

- Traffic management:
 - Traffic signals
 - Pedestrian signals
 - Work zone warning lights
 - Variable message signs
- Commercial outdoor advertising:
 - Signs
 - Marquees
- Automotive:
 - Exterior and interior lights

Device Selection Guide

| Typical Viewing Angle $2\theta_{1/2}$ (Deg.) ^[4] | Color and Dominant Wavelength (nm), Typ. ^[3] | Lamps without Standoffs on Leads (Outline Drawing A) | Lamps with Standoffs on Leads (Outline Drawing B) | Luminous Intensity I _v (mcd) ^[1,2,5] @ 20 mA | |
|--|---|--|---|---|-------|
| | | | | Min. | Max. |
| 8° | Amber 590 | HLMP-EL08-T0000 | HLMP-EL10-T0000 | 2500 | – |
| | | HLMP-EL08-VY000 | HLMP-EL10-VY000 | 4200 | 12000 |
| | | HLMP-EL08-VYK00 | | 4200 | 12000 |
| | | HLMP-EL08-WZ000 | HLMP-EL10-WZ000 | 5500 | 16000 |
| | | HLMP-EL08-X1K00 | HLMP-EL10-X1K00 | 7200 | 21000 |
| | | HLMP-EL08-X1000 | HLMP-EL10-X1000 | 7200 | 21000 |
| | Orange 605 | HLMP-EJ08-WZ000 | | 5500 | 16000 |
| | | HLMP-EJ08-X1000 | HLMP-EJ10-X1000 | 7200 | 21000 |
| | | HLMP-EJ08-Y2000 | | 9300 | 27000 |
| | Red-Orange 615 | HLMP-EH08-UX000 | HLMP-EH10-UX000 | 3200 | 9300 |
| | | HLMP-EH08-WZ000 | HLMP-EH10-WZ000 | 5500 | 16000 |
| | | HLMP-EH08-X1000 | HLMP-EH10-X1000 | 7200 | 21000 |
| | | HLMP-EH08-Y2000 | HLMP-EH10-Y2000 | 9300 | 27000 |
| | Red 626 | HLMP-EG08-T0000 | HLMP-EG10-T0000 | 2500 | – |
| | | HLMP-EG08-VY000 | | 4200 | 12000 |
| | | HLMP-EG08-WZ000 | HLMP-EG10-WZ000 | 5500 | 16000 |
| | | HLMP-EG08-X1000 | HLMP-EG10-X1000 | 7200 | 21000 |
| | | HLMP-EG08-YZ000 | | 9300 | 16000 |
| | | HLMP-EG08-Y2000 | HLMP-EG10-Y2000 | 9300 | 27000 |

Notes:

1. The luminous intensity is measured on the mechanical axis of the lamp package.
2. The optical axis is closely aligned with the package mechanical axis.
3. The dominant wavelength, λ_d , is derived from the CIE Chromaticity Diagram and represents the color of the lamp.
4. $\theta_{1/2}$ is the off-axis angle where the luminous intensity is half the on-axis intensity.
5. Tolerance for each intensity bin limit is $\pm 15\%$.

Device Selection Guide

| Typical Viewing Angle 2 $\theta_{1/2}$ (Deg.) ^[4] | Color and Dominant Wavelength (nm), Typ. ^[3] | Lamps without Standoffs on Leads (Outline Drawing A) | Lamps with Standoffs on Leads (Outline Drawing B) | Luminous Intensity I _v (mcd) ^[1,2,5] @ 20 mA | | |
|---|---|--|---|--|-------|------|
| | | | | Min. | Max. | |
| 15° | Amber 590 | | HLMP-EL17-M0000 | 520 | – | |
| | | HLMP-EL15-PS000 | | 880 | 2500 | |
| | | HLMP-EL15-QSK00 | | 1150 | 2500 | |
| | | HLMP-EL15-QT000 | | 1150 | 3200 | |
| | | HLMP-EL15-RU000 | | 1500 | 4200 | |
| | | HLMP-EL15-TW000 | HLMP-EL17-TW000 | 2500 | 7200 | |
| | | HLMP-EL15-TWK00 | | 2500 | 7200 | |
| | | HLMP-EL15-UX000 | HLMP-EL17-UX000 | 3200 | 9300 | |
| | | HLMP-EL15-VY000 | HLMP-EL17-VY000 | 4200 | 12000 | |
| | | HLMP-EL15-VYK00 | | 4200 | 12000 | |
| | HLMP-EL15-VW000 | | 4200 | 7200 | | |
| | Orange 605 | | | HLMP-EJ17-QT000 | 1150 | 3200 |
| | | HLMP-EJ15-PS000 | | | 880 | 2500 |
| | | HLMP-EJ15-RU000 | | | 1500 | 4200 |
| | | HLMP-EJ15-SV000 | HLMP-EJ17-SV000 | | 1900 | 5500 |
| | Red-Orange 615 | HLMP-EH15-QT000 | | | 1150 | 3200 |
| | | HLMP-EH15-RU000 | | | 1500 | 4200 |
| | | HLMP-EH15-TW000 | HLMP-EH17-TW000 | | 2500 | 7200 |
| | | HLMP-EH15-UX000 | HLMP-EH17-UX000 | | 3200 | 9300 |
| | Red 626 | HLMP-EG15-N0000 | | HLMP-EG17-N0000 | 680 | – |
| | | HLMP-EG15-PS000 | | | 880 | 2500 |
| | | HLMP-EG15-QT000 | HLMP-EG17-QT000 | | 1150 | 3200 |
| | | HLMP-EG15-RU000 | HLMP-EG17-RU000 | | 1500 | 4200 |
| | | HLMP-EG15-UX000 | HLMP-EG17-UX000 | | 3200 | 9300 |
| | | HLMP-EG15-TW000 | HLMP-EG17-TW000 | | 2500 | 7200 |

Notes:

1. The luminous intensity is measured on the mechanical axis of the lamp package.
2. The optical axis is closely aligned with the package mechanical axis.
3. The dominant wavelength, λ_d , is derived from the CIE Chromaticity Diagram and represents the color of the lamp.
4. $\theta_{1/2}$ is the off-axis angle where the luminous intensity is half the on-axis intensity.
5. Tolerance for each intensity bin limit is $\pm 15\%$.

Device Selection Guide

| Typical Viewing Angle $2\theta_{1/2}$ (Deg.) ^[4] | Color and Dominant Wavelength (nm), Typ. ^[3] | Lamps without Standoffs on Leads (Outline Drawing A) | Lamps with Standoffs on Leads (Outline Drawing B) | Luminous Intensity I _v (mcd) ^[1,2,5] @ 20 mA | |
|--|---|--|---|---|------|
| | | | | Min. | Max. |
| 23° | Amber 590 | HLMP-EL24-L0000 | HLMP-EL26-L0000 | 400 | – |
| | | HLMP-EL24-MQ000 | | 520 | 1500 |
| | | HLMP-EL24-NR000 | | 680 | 1900 |
| | | HLMP-EL24-PS000 | HLMP-EL26-PS000 | 880 | 2500 |
| | | HLMP-EL24-QR000 | | 1150 | 1900 |
| | | HLMP-EL24-QRK00 | | 1150 | 1900 |
| | | HLMP-EL24-QS400 | | 1150 | 2500 |
| | | HLMP-EL24-QT000 | HLMP-EL26-QT000 | 1150 | 3200 |
| | | HLMP-EL24-RU000 | HLMP-EL26-RU000 | 1150 | 4200 |
| | | HLMP-EL24-RUK00 | | 1150 | 4200 |
| | | HLMP-EL24-SV000 | HLMP-EL26-SV000 | 1900 | 5500 |
| | | HLMP-EL24-SUK00 | | 1900 | 4200 |
| | | HLMP-EL24-SU400 | | 1900 | 4200 |
| | | HLMP-EL24-SVK00 | | 1900 | 5500 |
| | | HLMP-EL24-TW000 | HLMP-EL26-TW000 | 2500 | 7200 |
| | | HLMP-EL24-TWK00 | | 2500 | 7200 |
| | Orange 605 | HLMP-EJ24-QT000 | | 1150 | 3200 |
| | Red-Orange 615 | HLMP-EH24-PS000 | HLMP-EH26-PS000 | 880 | 2500 |
| | | HLMP-EH24-QT000 | | 1150 | 3200 |
| | | HLMP-EH24-RU000 | | 1500 | 4200 |
| | | HLMP-EH24-SV000 | HLMP-EH26-SV000 | 1900 | 5500 |
| | Red 626 | HLMP-EG24-M0000 | HLMP-EG26-M0000 | 520 | – |
| | | HLMP-EG24-PS000 | HLMP-EG26-PS000 | 880 | 2500 |
| | | HLMP-EG24-QT000 | | 1150 | 4200 |
| | | HLMP-EG24-RU000 | HLMP-EG26-RU000 | 1500 | 4200 |

Notes:

1. The luminous intensity is measured on the mechanical axis of the lamp package.
2. The optical axis is closely aligned with the package mechanical axis.
3. The dominant wavelength, λ_d , is derived from the CIE Chromaticity Diagram and represents the color of the lamp.
4. $\theta_{1/2}$ is the off-axis angle where the luminous intensity is half the on-axis intensity.
5. Tolerance for each intensity bin limit is $\pm 15\%$.

Device Selection Guide

| Typical Viewing Angle $2\theta_{1/2}$ (Deg.) ^[4] | Color and Dominant Wavelength (nm), Typ. ^[3] | Lamps without Standoffs on Leads (Outline Drawing A) | Lamps with Standoffs on Leads (Outline Drawing B) | Luminous Intensity I _v (mcd) ^[1,2,5] @ 20 mA | |
|--|---|--|---|---|------|
| | | | | Min. | Max. |
| 30° | Amber 590 | HLMP-EL30-K0000 | HLMP-EL32-K0000 | 310 | – |
| | | HLMP-EL30-MQ000 | | 520 | 1500 |
| | | | HLMP-EL32-NR000 | 680 | 1900 |
| | | HLMP-EL30-PQ000 | | 880 | 1500 |
| | | HLMP-EL30-PR400 | | 880 | 1900 |
| | | HLMP-EL30-PS000 | HLMP-EL32-PS000 | 880 | 2500 |
| | | HLMP-EL30-PSK00 | | 880 | 2500 |
| | | HLMP-EL30-QT000 | HLMP-EL32-QT000 | 1150 | 3200 |
| | | HLMP-EL30-QTK00 | | 1150 | 3200 |
| | | HLMP-EL30-ST000 | | 1900 | 3200 |
| | | HLMP-EL30-SU400 | | 1900 | 4200 |
| | | HLMP-EL30-SUK00 | | 1900 | 4200 |
| | | HLMP-EL30-STK00 | | 1900 | 3200 |
| | | HLMP-EL30-SV000 | HLMP-EL32-SV000 | 1900 | 5500 |
| | | HLMP-EL30-SVK00 | | 1900 | 5500 |
| | Orange 605 | HLMP-EJ30-NR000 | | 680 | 1900 |
| | | HLMP-EJ30-PS000 | HLMP-EJ32-PS000 | 880 | 2500 |
| | Red-Orange 615 | HLMP-EH30-MQ000 | HLMP-EH32-MQ000 | 520 | 1500 |
| | | HLMP-EH30-NR000 | HLMP-EH32-NR000 | 680 | 1900 |
| | | HLMP-EH30-PS000 | HLMP-EH32-PS000 | 880 | 2500 |
| | | HLMP-EH30-QT000 | HLMP-EH32-QT000 | 1150 | 4200 |
| | | HLMP-EH30-RU000 | HLMP-EH32-RU000 | 1500 | 4200 |
| | Red 626 | HLMP-EG30-K0000 | HLMP-EG32-K0000 | 270 | – |
| | | HLMP-EG30-KN000 | | 310 | 880 |
| | | HLMP-EG30-MQ000 | HLMP-EG32-MQ000 | 520 | 1500 |
| | | HLMP-EG30-NQ000 | | 680 | 1500 |
| | | HLMP-EG30-NR000 | HLMP-EG32-NR000 | 680 | 1900 |
| | | HLMP-EG30-PQ000 | | 880 | 1500 |
| | | HLMP-EG30-PR000 | | 880 | 1900 |
| | | HLMP-EG30-PS000 | | 880 | 2500 |
| | HLMP-EG30-QT000 | HLMP-EG32-QT000 | 1150 | 3200 | |

Notes:

1. The luminous intensity is measured on the mechanical axis of the lamp package.
2. The optical axis is closely aligned with the package mechanical axis.
3. The dominant wavelength, λ_d , is derived from the CIE Chromaticity Diagram and represents the color of the lamp.
4. $\theta_{1/2}$ is the off-axis angle where the luminous intensity is half the on-axis intensity.
5. Tolerance for each intensity bin limit is $\pm 15\%$.

Part Numbering System

HLMP - X X XX - X X X XX

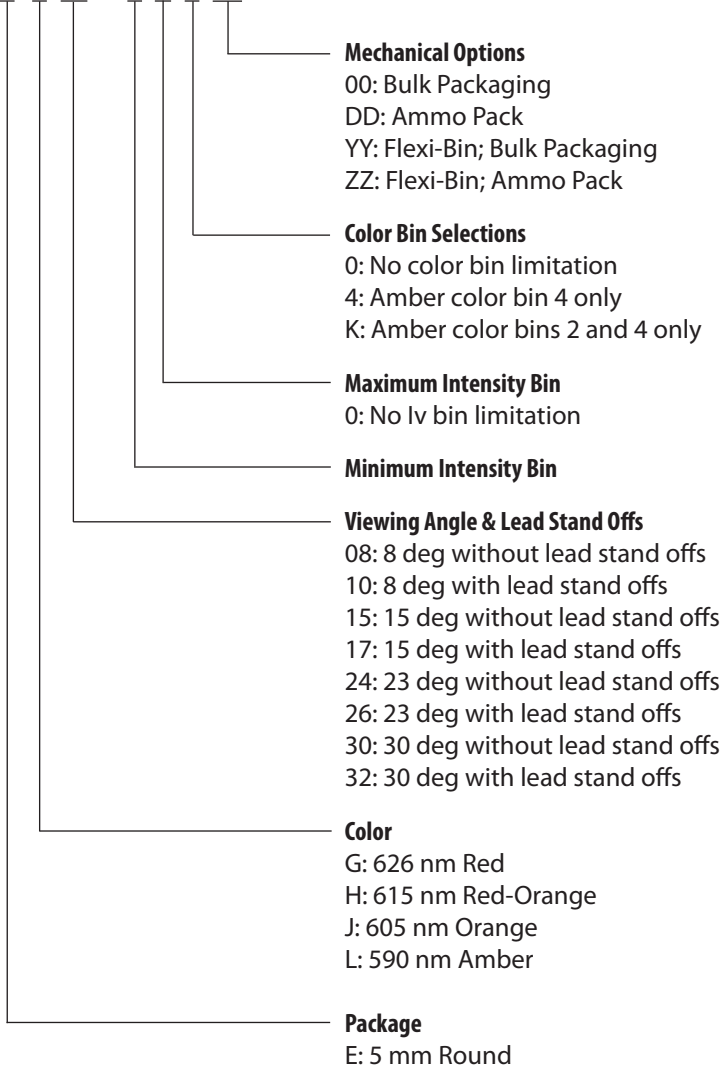

Note: Please refer to AB 5337 for complete information on part numbering system.

Package Dimensions

A

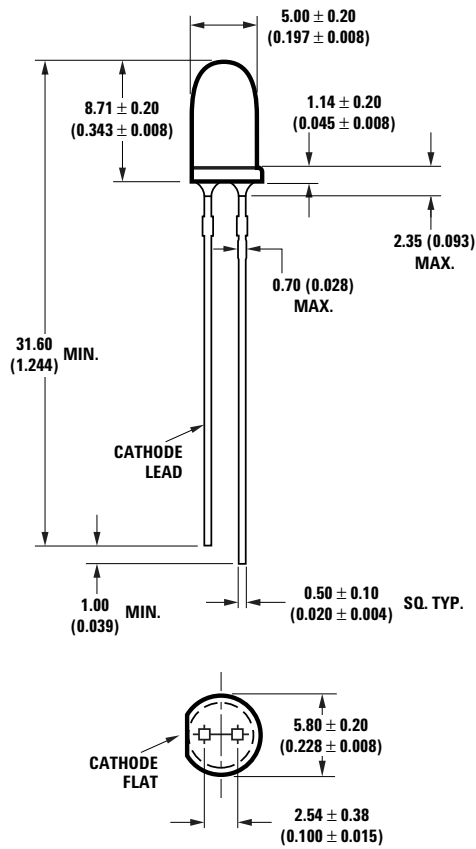

B

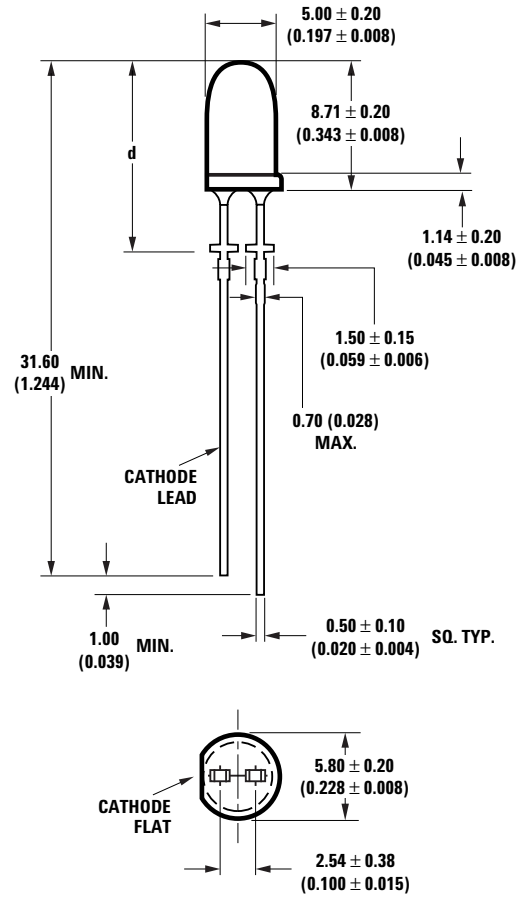

NOTES:

1. ALL DIMENSIONS ARE IN MILLIMETERS (INCHES).
2. TAPERS SHOWN AT TOP OF LEADS (BOTTOM OF LAMP PACKAGE) INDICATE AN EPOXY MENISCUS THAT MAY EXTEND ABOUT 1 mm (0.040 in.) DOWN THE LEADS.
3. FOR DOME HEIGHTS ABOVE LEAD STAND-OFF SEATING PLANE, d, LAMP PACKAGE B, SEE TABLE.

| PART NO. | d |
|-----------|---------------------------------|
| HLMP-XX10 | 12.37 ± 0.25 (0.487 ± 0.010) |
| HLMP-XX17 | 12.42 ± 0.25 (0.489 ± 0.010) |
| HLMP-XX26 | 12.52 ± 0.25 (0.493 ± 0.010) |
| HLMP-XX32 | 11.96 ± 0.25 (0.471 ± 0.010) |

Absolute Maximum Ratings at $T_A = 25^\circ\text{C}$

| | |
|--|-----------------|
| DC Forward Current ^[1,2,3] | 50 mA |
| Peak Pulsed Forward Current ^[2,3] | 100 mA |
| Average Forward Current ^[3] | 30 mA |
| Reverse Voltage ($I_R = 100 \mu\text{A}$) | 5 V |
| LED Junction Temperature | 130°C |
| Operating Temperature | -40°C to +100°C |
| Storage Temperature | -40°C to +100°C |

Notes:

- Derate linearly as shown in Figure 4.
- For long term performance with minimal light output degradation, drive currents between 10 mA and 30 mA are recommended. For more information on recommended drive conditions, please refer to Application Brief I-024.
- Operating at currents below 1 mA is not recommended. Please contact your local representative for further information.

Electrical/Optical Characteristics at $T_A = 25^\circ\text{C}$

| Parameter | Symbol | Min. | Typ. | Max. | Units | Test Conditions |
|---|--------------------------|------|------|------|--------------------|--|
| Forward Voltage | | | | | | $I_F = 20 \text{ mA}$ |
| Amber ($\lambda_d = 590 \text{ nm}$) | V_F | | 2.02 | 2.4 | V | |
| Orange ($\lambda_d = 605 \text{ nm}$) | | 1.98 | | | | |
| Red-Orange ($\lambda_d = 615 \text{ nm}$) | | 1.94 | | | | |
| Red ($\lambda_d = 626 \text{ nm}$) | | 1.90 | | | | |
| Reverse Voltage | V_R | 5 | 20 | | V | $I_F = 100 \mu\text{A}$ |
| Peak Wavelength: | | | | | | Peak of Wavelength of Spectral Distribution at $I_F = 20 \text{ mA}$ |
| Amber ($\lambda_d = 590 \text{ nm}$) | λ_{PEAK} | | 592 | | nm | |
| Orange ($\lambda_d = 605 \text{ nm}$) | | 609 | | | | |
| Red-Orange ($\lambda_d = 615 \text{ nm}$) | | 621 | | | | |
| Red ($\lambda_d = 626 \text{ nm}$) | | 635 | | | | |
| Spectral Halfwidth | $\Delta\lambda_{1/2}$ | | 17 | | nm | Wavelength Width at Spectral Distribution $1/2$ Power Point at $I_F = 20 \text{ mA}$ |
| Speed of Response | τ_s | | 20 | | ns | Exponential Time Constant, e^{-t/τ_s} |
| Capacitance | C | | 40 | | pF | $V_F = 0, f = 1 \text{ MHz}$ |
| Thermal Resistance | $R\theta_{\text{J-PIN}}$ | | 240 | | $^\circ\text{C/W}$ | LED Junction-to-Cathode Lead |
| Luminous Efficacy ^[1] | | | | | | Emitted Luminous Power/Emitted Radiant Power |
| Amber ($\lambda_d = 590 \text{ nm}$) | η_v | | 480 | | lm/W | |
| Orange ($\lambda_d = 605 \text{ nm}$) | | 370 | | | | |
| Red-Orange ($\lambda_d = 615 \text{ nm}$) | | 260 | | | | |
| Red ($\lambda_d = 626 \text{ nm}$) | | 150 | | | | |
| Luminous Flux | ϕ_v | | 500 | | mIm | $I_F = 20 \text{ mA}$ |
| Luminous Efficiency ^[2] | η_e | | | | lm/W | Emitted Luminous Flux/Electrical Power |
| Amber | | | 12 | | | |
| Orange | | 13 | | | | |
| Red-Orange | | 13 | | | | |
| Red | | 13 | | | | |

Note:

- The radiant intensity, I_e , in watts per steradian, may be found from the equation $I_e = I_v / \eta_v$, where I_v is the luminous intensity in candelas and η_v is the luminous efficacy in lumens/watt.
- $\eta_e = \phi_v / I_F \times V_F$, where ϕ_v is the emitted luminous flux, I_F is electrical forward current and V_F is the forward voltage.

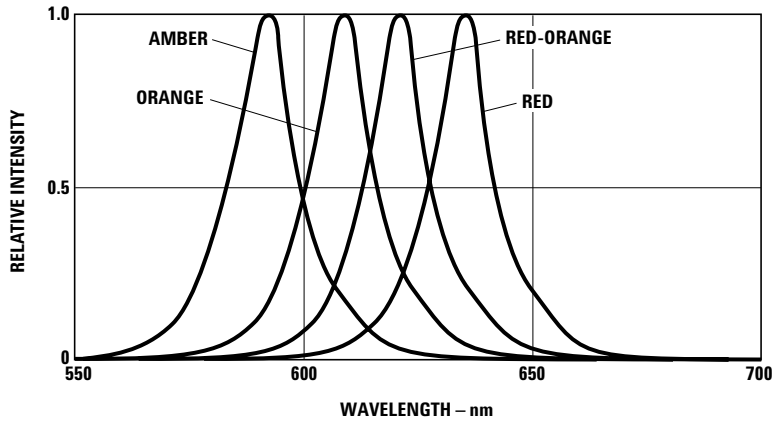

Figure 1. Relative intensity vs. peak wavelength

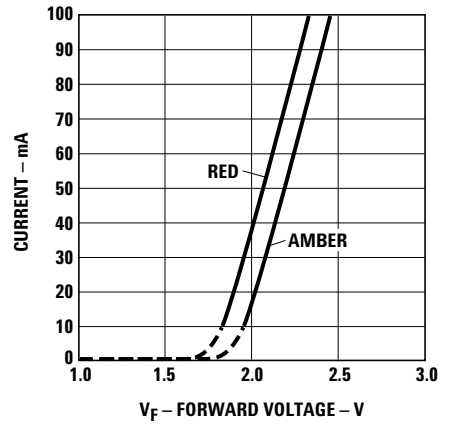

Figure 2. Forward current vs. forward voltage

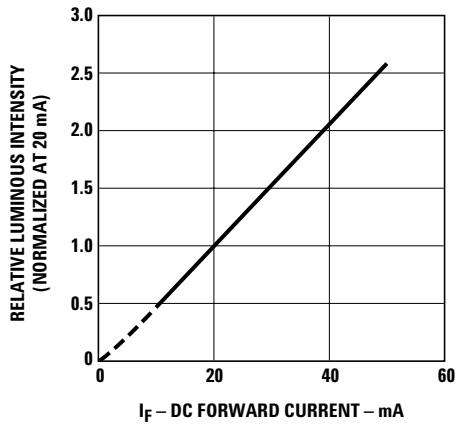

Figure 3. Relative luminous intensity vs. forward current

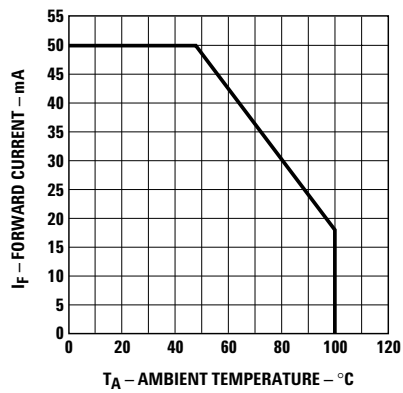

Figure 4. Maximum forward current vs. ambient temperature

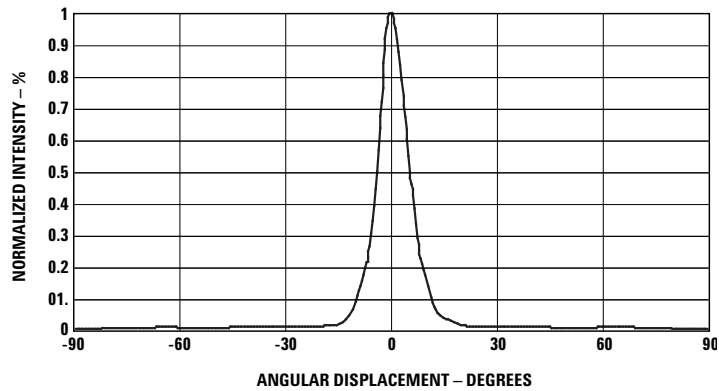

Figure 5. Representative spatial radiation pattern for 8° viewing angle lamps

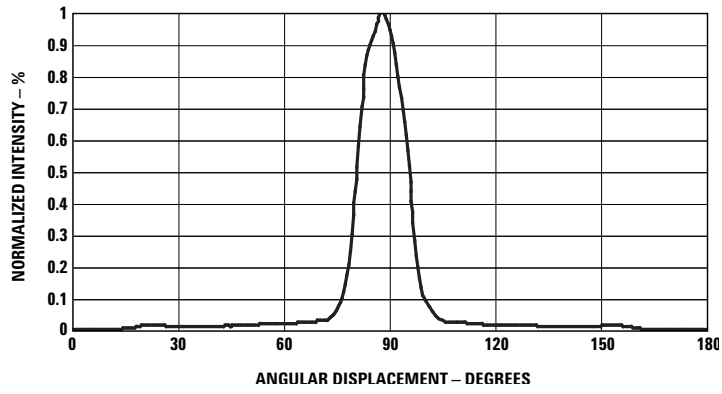

Figure 6. Representative spatial radiation pattern for 15° viewing angle lamps

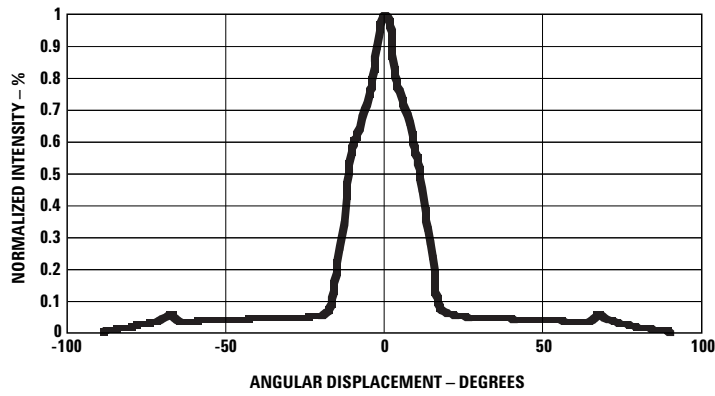

Figure 7. Representative spatial radiation pattern for 23° viewing angle lamps

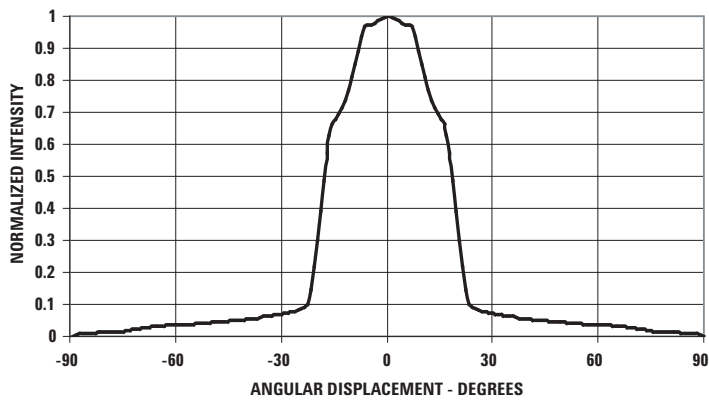

Figure 8. Representative spatial radiation pattern for 30° viewing angle lamps

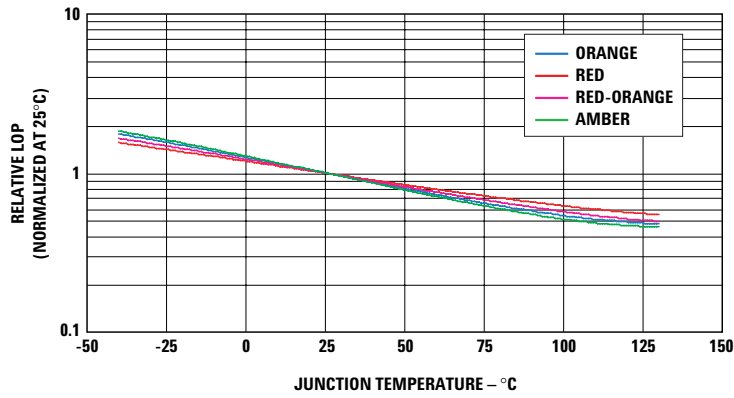

Figure 9. Relative light output vs. junction temperature

Intensity Bin Limits (mcd at 20 mA)

| Bin Name | Min. | Max. |
|----------|-------|-------|
| K | 310 | 400 |
| L | 400 | 520 |
| M | 520 | 680 |
| N | 680 | 880 |
| P | 880 | 1150 |
| Q | 1150 | 1500 |
| R | 1500 | 1900 |
| S | 1900 | 2500 |
| T | 2500 | 3200 |
| U | 3200 | 4200 |
| V | 4200 | 5500 |
| W | 5500 | 7200 |
| X | 7200 | 9300 |
| Y | 9300 | 12000 |
| Z | 12000 | 16000 |
| 1 | 16000 | 21000 |
| 2 | 21000 | 27000 |

Tolerance for each bin limit is $\pm 15\%$.

Amber Color Bin Limits (nm at 20 mA)

| Bin Name | Min. | Max. |
|----------|-------|-------|
| 1 | 584.5 | 587.0 |
| 2 | 587.0 | 589.5 |
| 4 | 589.5 | 592.0 |
| 6 | 592.0 | 594.5 |

Tolerance for each bin limit is ± 0.5 nm.

Note:

1. Bin categories are established for classification of products. Products may not be available in all bin categories.

Precautions:

Lead Forming:

- The leads of an LED lamp may be preformed or cut to length prior to insertion and soldering on PC board.
- For better control, it is recommended to use proper tool to precisely form and cut the leads to applicable length rather than doing it manually.
- If manual lead cutting is necessary, cut the leads after the soldering process. The solder connection forms a mechanical ground which prevents mechanical stress due to lead cutting from traveling into LED package. This is highly recommended for hand solder operation, as the excess lead length also acts as small heat sink.

Soldering and Handling:

- Care must be taken during PCB assembly and soldering process to prevent damage to the LED component.
- LED component may be effectively hand soldered to PCB. However, it is only recommended under unavoidable circumstances such as rework. The closest manual soldering distance of the soldering heat source (soldering iron's tip) to the body is 1.59mm. Soldering the LED using soldering iron tip closer than 1.59mm might damage the LED.

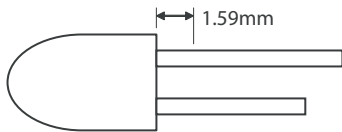

- ESD precaution must be properly applied on the soldering station and personnel to prevent ESD damage to the LED component that is ESD sensitive. Do refer to Avago application note AN 1142 for details. The soldering iron used should have grounded tip to ensure electrostatic charge is properly grounded.
- Recommended soldering condition:

| | Wave Soldering [1, 2] | Manual Solder Dipping |
|----------------------|-----------------------|-----------------------|
| Pre-heat temperature | 105 °C Max. | - |
| Preheat time | 60 sec Max | - |
| Peak temperature | 250 °C Max. | 260 °C Max. |
| Dwell time | 3 sec Max. | 5 sec Max |

Note:

- 1) Above conditions refers to measurement with thermocouple mounted at the bottom of PCB.
 - 2) It is recommended to use only bottom preheaters in order to reduce thermal stress experienced by LED.
- Wavesoldering parameters must be set and maintained according to the recommended temperature and dwell time. Customer is advised to perform daily check on the soldering profile to ensure that it is always conforming to recommended soldering conditions.

Note:

1. PCB with different size and design (component density) will have different heat mass (heat capacity). This might cause a change in temperature experienced by the board if same wave soldering setting is used. So, it is recommended to re-calibrate the soldering profile again before loading a new type of PCB.
2. Avago Technologies' high brightness LED are using high efficiency LED die with single wire bond as shown below. Customer is advised to take extra precaution during wave soldering to ensure that the maximum wave temperature does not exceed 250°C and the solder contact time does not exceeding 3sec. Over-stressing the LED during soldering process might cause premature failure to the LED due to delamination.

Avago Technologies LED configuration

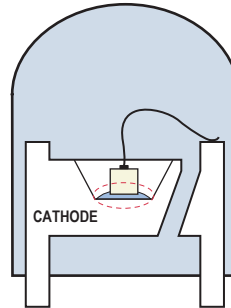

Note: Electrical connection between bottom surface of LED die and the lead frame is achieved through conductive paste.

- Any alignment fixture that is being applied during wave soldering should be loosely fitted and should not apply weight or force on LED. Non metal material is recommended as it will absorb less heat during wave soldering process.
- At elevated temperature, LED is more susceptible to mechanical stress. Therefore, PCB must allowed to cool down to room temperature prior to handling, which includes removal of alignment fixture or pallet.
- If PCB board contains both through hole (TH) LED and other surface mount components, it is recommended that surface mount components be soldered on the top side of the PCB. If surface mount need to be on the bottom side, these components should be soldered using reflow soldering prior to insertion the TH LED.
- Recommended PC board plated through holes (PTH) size for LED component leads.

| LED component lead size | Diagonal | Plated through hole diameter |
|---------------------------------------|--------------------------|--|
| 0.45 x 0.45 mm (0.018x 0.018 inch) | 0.636 mm (0.025 inch) | 0.98 to 1.08 mm (0.039 to 0.043 inch) |
| 0.50 x 0.50 mm (0.020x 0.020 inch) | 0.707 mm (0.028 inch) | 1.05 to 1.15 mm (0.041 to 0.045 inch) |

- Over-sizing the PTH can lead to twisted LED after clinching. On the other hand under sizing the PTH can cause difficulty inserting the TH LED.

Refer to application note AN5334 for more information about soldering and handling of high brightness TH LED lamps.

Example of Wave Soldering Temperature Profile for TH LED

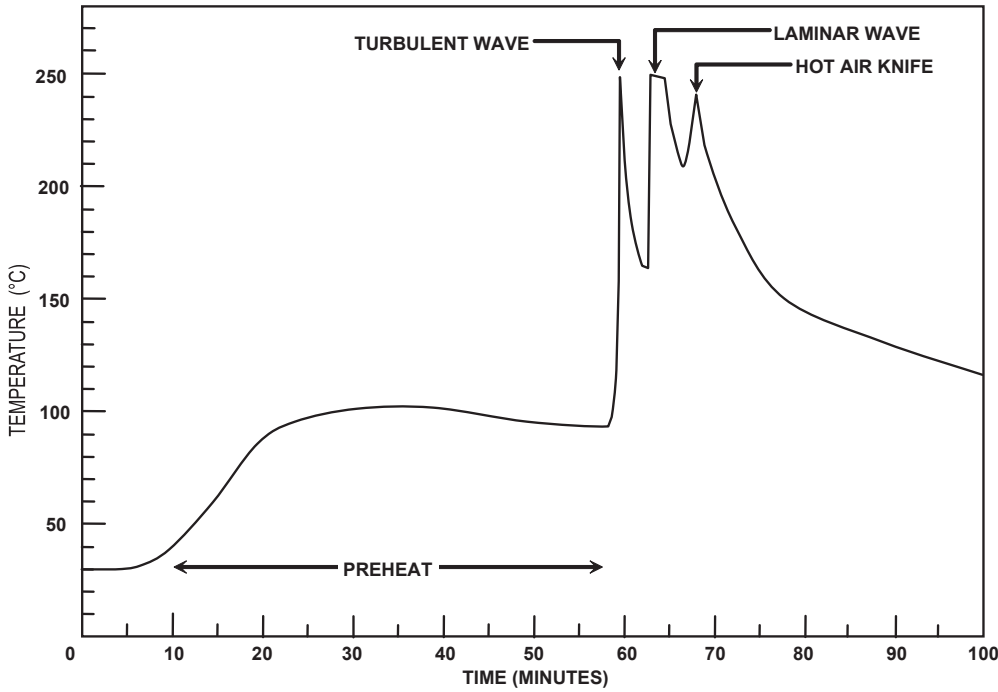

Recommended solder:
 Sn63 (Leaded solder alloy)
 SAC305 (Lead free solder alloy)

Flux: Rosin flux

Solder bath temperature:
 245°C ± 5°C (maximum peak
 temperature = 250°C)

Dwell time: 1.5 sec - 3.0 sec
 (maximum = 3sec)

Note: Allow for board to be sufficiently cooled to room temperature before exerting mechanical force.

Figure 10. Recommended wave soldering profile

Ammo Pack Drawing

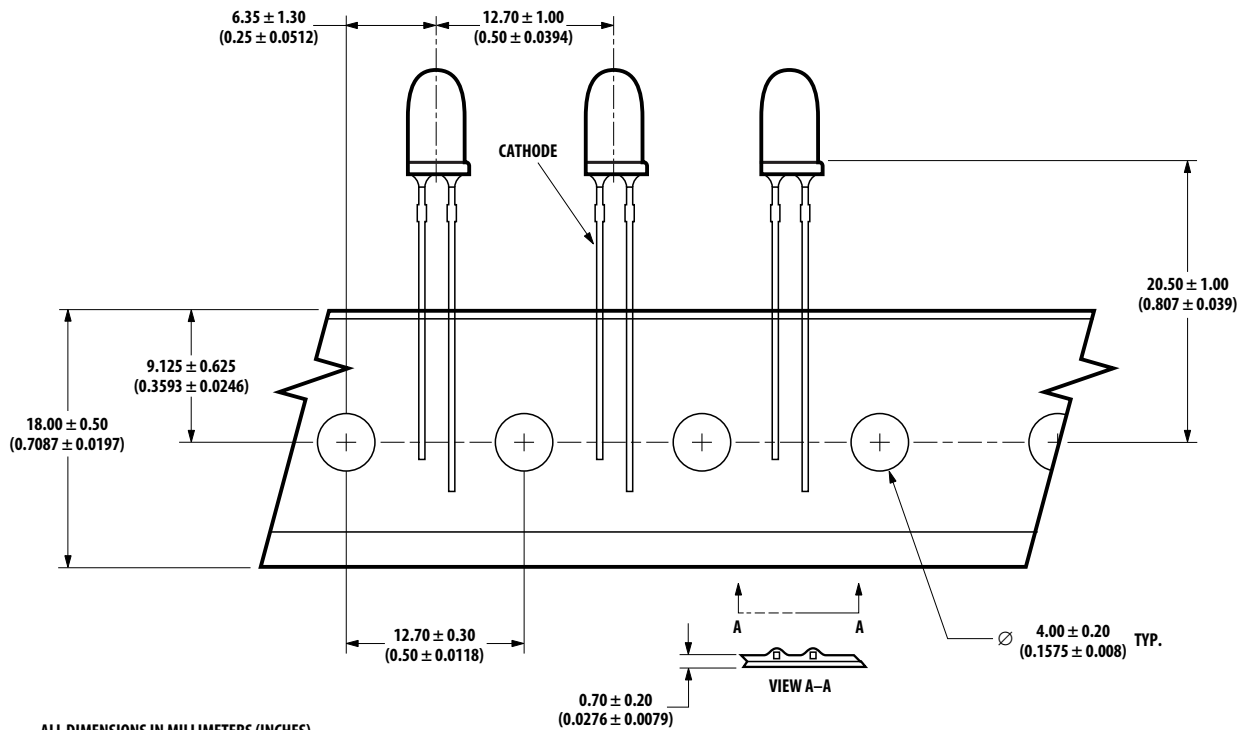

ALL DIMENSIONS IN MILLIMETERS (INCHES).

NOTE: THE AMMO-PACKS DRAWING IS APPLICABLE FOR PACKAGING OPTION -DD & -ZZ AND REGARDLESS OF STANDOFF OR NON-STANDOFF.

Packaging Box for Ammo Packs

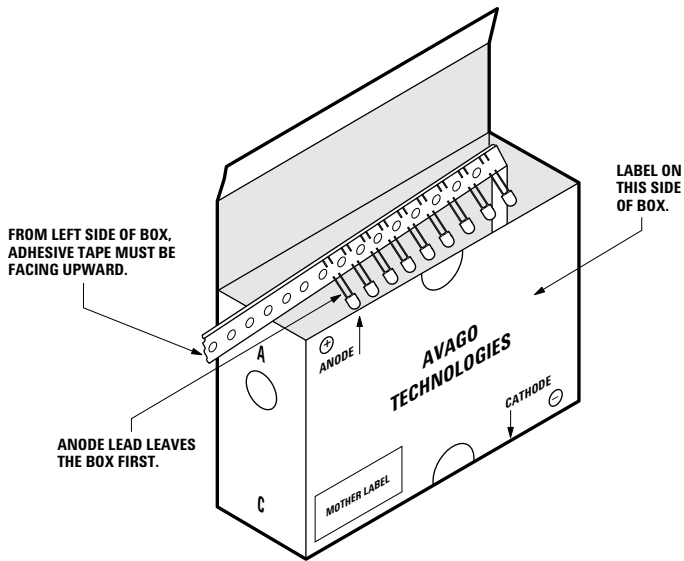











NOTE:
THE DIMENSION FOR AMMO PACK IS APPLICABLE FOR THE DEVICE WITH STANDOFF AND WITHOUT STANDOFF.

Packaging Label:

(i) Avago Mother Label: (Available on packaging box of ammo pack and shipping box)

| | |
|---|--|
| <p>Avago TECHNOLOGIES</p> <p>STANDARD LABEL LS0002 RoHS Compliant e3 max temp 250C</p> | |
| <p>(1P) Item: Part Number </p> | <p>(Q) QTY: Quantity </p> |
| <p>(1T) Lot: Lot Number </p> | <p>CAT: Intensity Bin </p> |
| <p>LPN: </p> | <p>BIN: Refer to below information</p> |
| <p>(9D)MFG Date: Manufacturing Date </p> | |
| <hr/> | |
| <p>(P) Customer Item: </p> | |
| <p>(V) Vendor ID: </p> | <p>(9D) Date Code: Date Code </p> |
| <p>DeptID: </p> | <p>Made In: Country of Origin </p> |

(ii) Avago Baby Label (Only available on bulk packaging)

| | | |
|---|---|------------------------------------|
|  Avago TECHNOLOGIES | | RoHS Compliant e3 max temp 250C |
| Lamps Baby Label | | |
| (1P) PART #: Part Number | | |
|  | | |
| (1T) LOT #: Lot Number | | |
|  | | |
| (9D)MFG DATE: Manufacturing Date | QUANTITY: Packing Quantity | |
|  |  | |
| C/O: Country of Origin | | |
| Customer P/N: | CAT: Intensity Bin | |
|  |  | |
| Supplier Code: | BIN: Refer to below information | |
|  |  | |
| | DATECODE: Date Code | |
| |  | |

Acronyms and Definition:

BIN:

(i) Color bin only or VF bin only

(Applicable for part number with color bins but without VF bin OR part number with VF bins and no color bin)

OR

(ii) Color bin incorporated with VF Bin

(Applicable for part number that have both color bin and VF bin)

Example:

(i) Color bin only or VF bin only

BIN: 2 (represent color bin 2 only)

BIN: VB (represent VF bin "VB" only)

(ii) Color bin incorporate with VF Bin

BIN: 2VB



DISCLAIMER: AVAGO'S PRODUCTS AND SOFTWARE ARE NOT SPECIFICALLY DESIGNED, MANUFACTURED OR AUTHORIZED FOR SALE AS PARTS, COMPONENTS OR ASSEMBLIES FOR THE PLANNING, CONSTRUCTION, MAINTENANCE OR DIRECT OPERATION OF A NUCLEAR FACILITY OR FOR USE IN MEDICAL DEVICES OR APPLICATIONS. CUSTOMER IS SOLELY RESPONSIBLE, AND WAIVES ALL RIGHTS TO MAKE CLAIMS AGAINST AVAGO OR ITS SUPPLIERS, FOR ALL LOSS, DAMAGE, EXPENSE OR LIABILITY IN CONNECTION WITH SUCH USE.

For product information and a complete list of distributors, please go to our website: www.avagotech.com

Avago, Avago Technologies, and the A logo are trademarks of Avago Technologies in the United States and other countries. Data subject to change. Copyright © 2005–2008 Avago Technologies. All rights reserved. Obsoletes 5989-4368EN AV02-0373EN - September 2, 2008

