

# ASMT-Jx32

## 3W Mini Power LED Light Source



### Data Sheet



#### Description

The 3W Mini Power LED Light Source is a high performance energy efficient device which can handle high thermal and high driving current. The metal slug is electrically isolated.

The White Mini Power LED is available in the range of color temperature from 2700K to 10000K.

The low profile package design and ultra small footprint is suitable for a wide variety of applications especially where space and height is a constraint.

The package is compatible with reflow soldering process. To facilitate easy pick & place assembly, the LEDs are packed in EIA-compliant tape and reel.

#### Features

- Available in Cool White, Neutral White and Warm White
- Small footprint and low profile
- Symmetrical outline
- Energy efficient
- Direct heat transfer from metal slug to mother board
- Compatible with reflow soldering process
- High current operation
- Long operation life
- Wide viewing angle
- Silicone encapsulation
- Non-ESD sensitive (threshold > 16kV)
- MSL 1 products

#### Applications

- Sign backlight
- Safety, exit and emergency sign lightings
- Specialty lighting such as task lighting and reading lights
- Retail display
- Commercial lighting
- Accent or marker lightings, strip or step lightings
- Portable lightings, bicycle head lamp, torch lights
- Decorative lighting
- Architectural lighting
- Pathway lighting
- Street lighting
- Pedestrian street lighting
- Tunnel lighting

**CAUTION:** Customer is advised to keep the LEDs in the MBB when not in use as prolonged exposure to environment might cause the silver plated leads to tarnish, which might cause difficulties in soldering.

## Package Dimensions

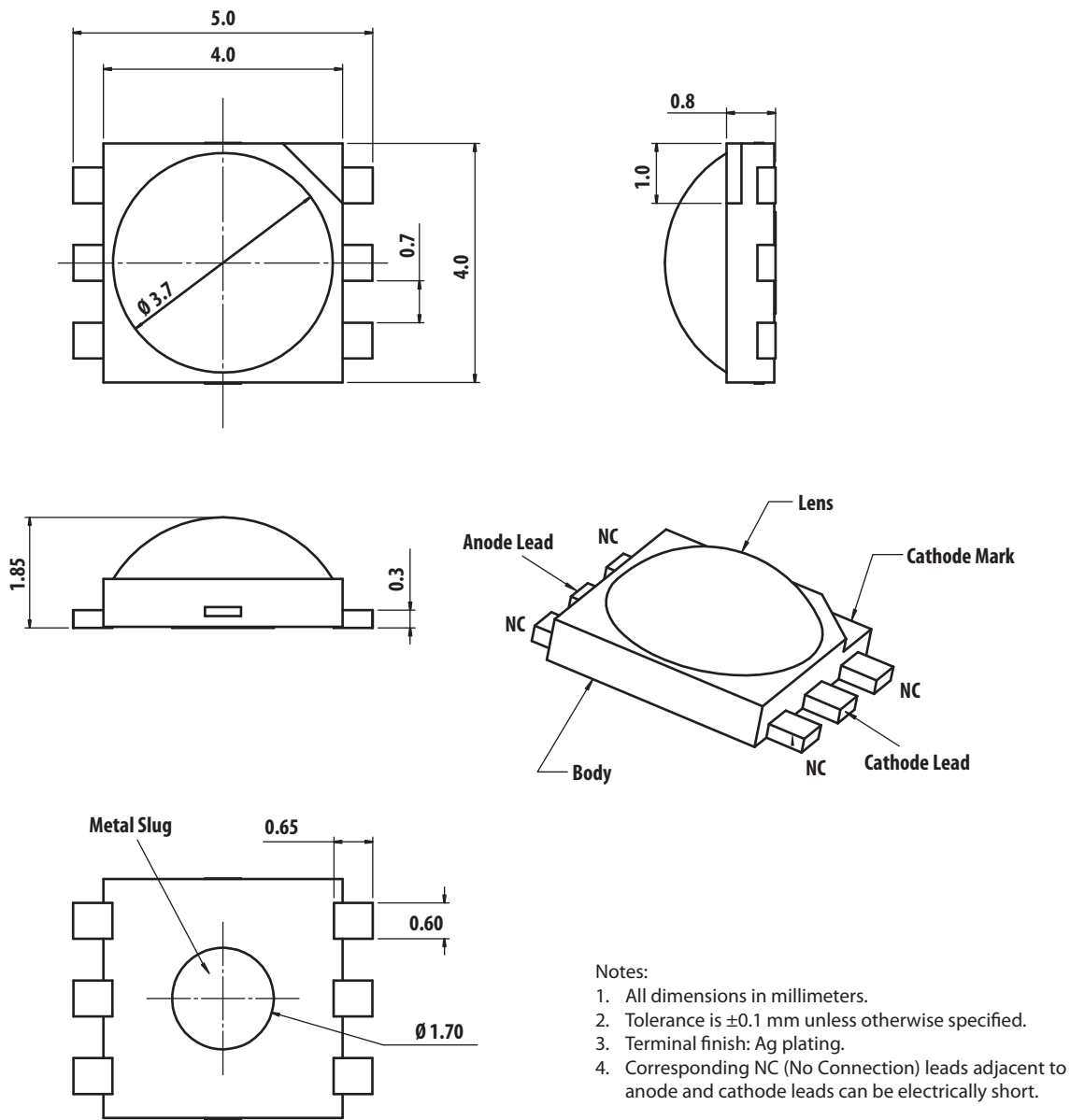
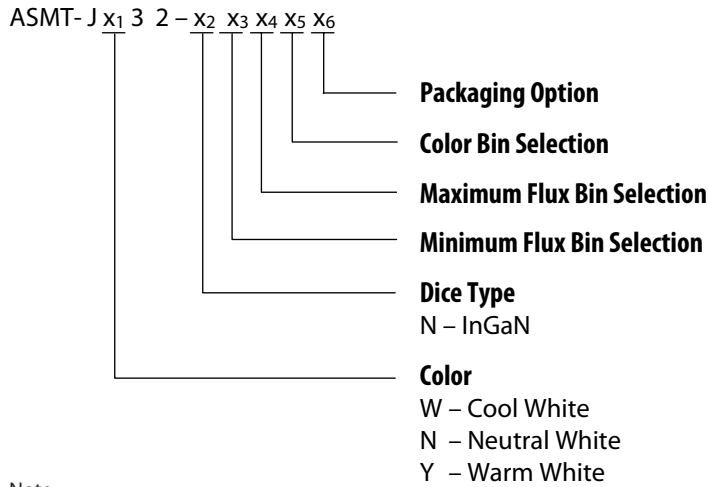

Figure 1. ASMT-Jx32 package outline drawing

## Part Numbering System



Note:

1. Please refer to Page 8 for selection details.

## Device Selection Guide (T<sub>J</sub> = 25°C)

Part Number	Color	Luminous Flux (lm), $\Phi_V^{[1,2]}$			Test Current (mA)	Dice Technology	Electrically Isolated Metal Slug
		Min.	Typ.	Max.			
ASMT-JW32-NUV01	Cool White	87.4	100.0	113.6	350	InGaN	Yes
ASMT-JW32-NVV01		99.6	105.0	113.6	350	InGaN	Yes
ASMT-JW32-NVW01		99.6	110.0	129.5	350	InGaN	Yes
ASMT-JW32-NWX01		113.6	125.0	147.7	350	InGaN	Yes
ASMT-JN32-NUV01	Neutral White	87.4	100.0	113.6	350	InGaN	Yes
ASMT-JN32-NVV01		99.6	105.0	113.6	350	InGaN	Yes
ASMT-JN32-NVW01		99.6	110.0	129.5	350	InGaN	Yes
ASMT-JN32-NWX01		113.6	125.0	147.7	350	InGaN	Yes
ASMT-JY32-NTV01	Warm White	67.2	90.0	113.6	350	InGaN	Yes
ASMT-JY32-NUW01		87.4	105.0	129.5	350	InGaN	Yes

Notes:

1.  $\Phi_V$  is the total luminous flux output as measured with an integrating sphere at 25ms mono pulse condition.
2. Flux tolerance is  $\pm 10\%$

## Absolute Maximum Ratings

Parameter	ASMT-Jx32	Units
DC Forward Current <sup>[1]</sup>	700	mA
Peak Pulsing Current	2400	mA
Power Dissipation	2730	mW
LED Junction Temperature	135	°C
Operating Metal Slug Temperature Range at 350 mA	-40 to +120	°C
Operating Metal Slug Temperature Range at 700 mA	-40 to +105	°C
Storage Temperature Range	-40 to + 120	°C
Soldering Temperature	Refer to Figure 15	
Reverse Voltage <sup>[2]</sup>	Not recommended	

Notes:

1. Derate linearly based on Figure 11.
2. Not designed for reverse bias operation.

### Optical Characteristics at 350 mA (T<sub>J</sub> = 25°C)

Part Number	Color	Correlated Color Temperature, CCT (Kelvin)		Viewing Angle, 2θ <sub>1/2</sub> <sup>[1]</sup> (°)	Luminous Efficiency (lm/W)
		Min.	Max.	Typ.	Typ.
ASMT-JW32-NUV01	Cool White	4500	10000	140	89
ASMT-JW32-NVV01		4500	10000	140	94
ASMT-JW32-NVW01		4500	10000	140	98
ASMT-JW32-NWX01		4500	10000	140	112
ASMT-JN32-NUV01	Neutral White	3500	4500	140	89
ASMT-JN32-NVV01		3500	4500	140	94
ASMT-JN32-NVW01		3500	4500	140	98
ASMT-JN32-NWX01		3500	4500	140	112
ASMT-JY32-NTV01	Warm White	2700	3500	140	80
ASMT-JY32-NUW01		2700	3500	140	94

Note:

1. θ<sub>1/2</sub> is the off-axis angle where the luminous intensity is 1/2 the peak intensity.

### Electrical Characteristic at 350 mA (T<sub>J</sub> = 25°C)

Dice Type	Forward Voltage, V <sub>F</sub> (Volts)			Thermal Resistance, R <sub>θJ-MS</sub> (°C/W) <sup>[1]</sup>
	Min.	Typ	Max.	Typ.
InGaN	2.8	3.2	3.5	9

Note:

1. R<sub>θJ-MS</sub> is Thermal Resistance from LED junction to metal slug.

### Optical and Electrical Characteristic at 700 mA (T<sub>J</sub> = 25°C)

Part Number	Color	Luminous Flux (lm), Φ <sub>v</sub>	Forward Voltage, V <sub>F</sub> (Volts)
		Typ.	Typ.
ASMT-JW32-NUV01	Cool White	175.0	3.6
ASMT-JW32-NVV01		180.0	3.6
ASMT-JW32-NVW01		187.0	3.6
ASMT-JW32-NWX01		213.0	3.6
ASMT-JN32-NUV01	Neutral White	175.0	3.6
ASMT-JN32-NVV01		180.0	3.6
ASMT-JN32-NVW01		187.0	3.6
ASMT-JN32-NWX01		213.0	3.6
ASMT-JY32-NTV01	Warm White	153.0	3.6
ASMT-JY32-NUW01		179	3.6

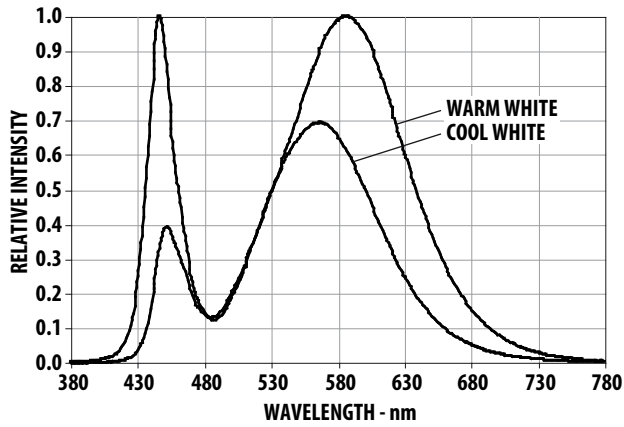

Figure 2. Relative Intensity vs. Wavelength for Cool White and Warm White

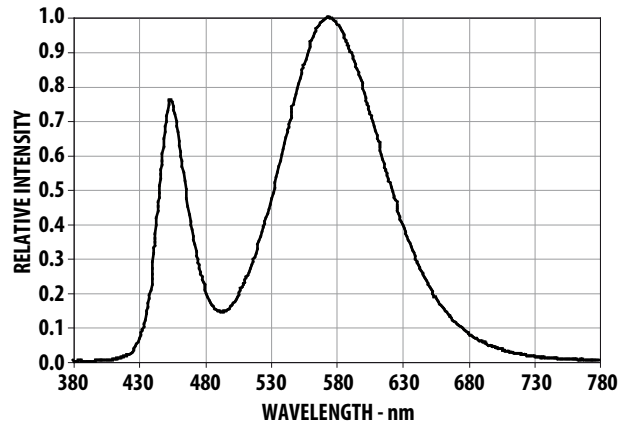

Figure 3. Relative Intensity vs. Wavelength for Neutral White

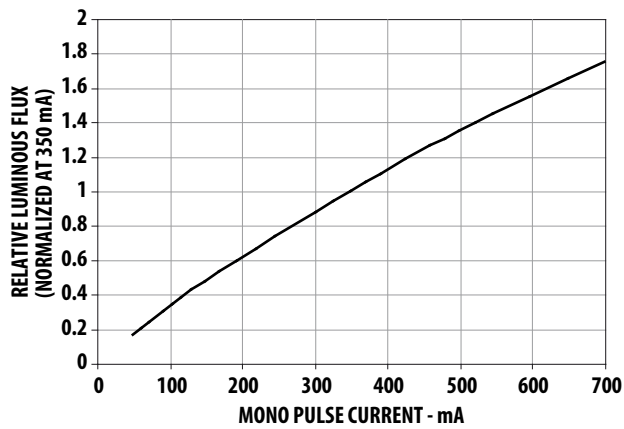

Figure 4. Relative Luminous Flux vs. Mono Pulse Current

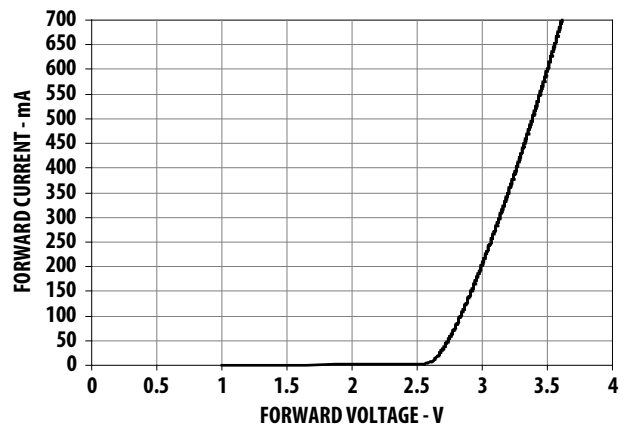

Figure 5. Forward Current vs. Forward Voltage

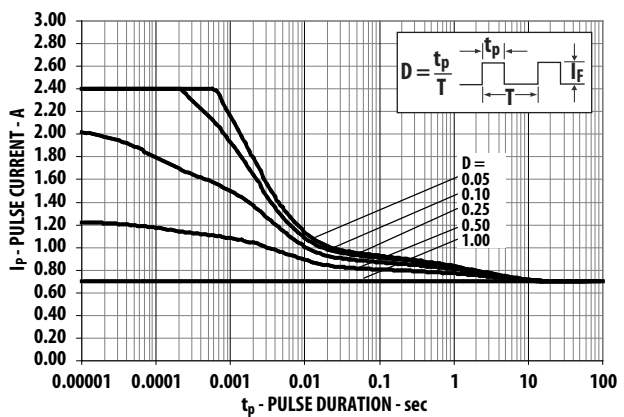

Figure 6. Maximum pulse current vs. pulse duration  
Derated based on  $T_A = 25^\circ\text{C}$ ,  $R\theta_{J-A} = 30^\circ\text{C/W}$ .

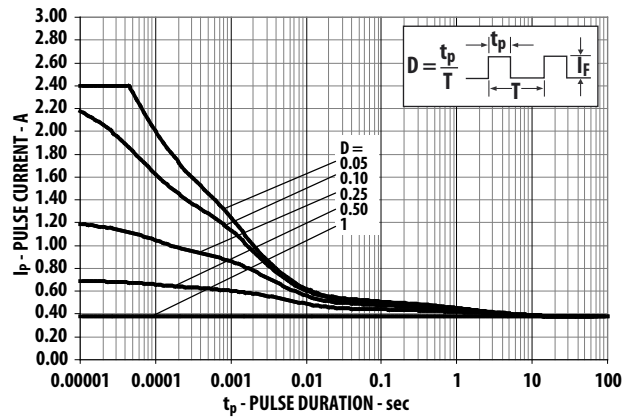

Figure 7. Maximum pulse current vs. pulse duration  
Derated based on  $T_A = 85^\circ\text{C}$ ,  $R\theta_{J-A} = 30^\circ\text{C/W}$ .

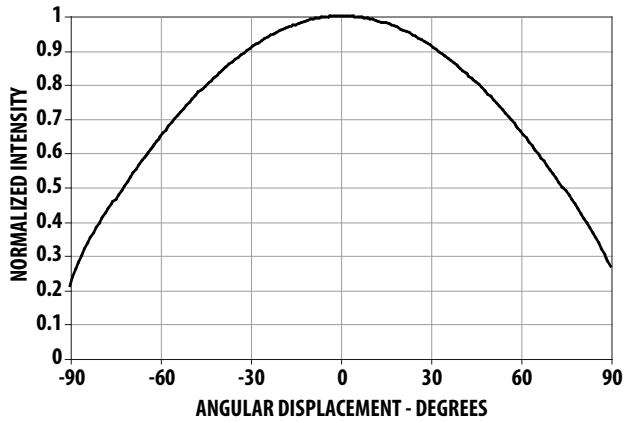

Figure 8. Radiation Pattern for Cool White, Warm White and Neutral White

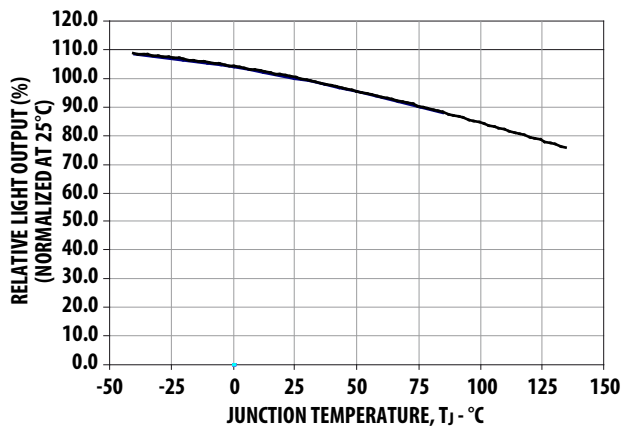

Figure 9. Relative Light Output vs. Junction Temperature

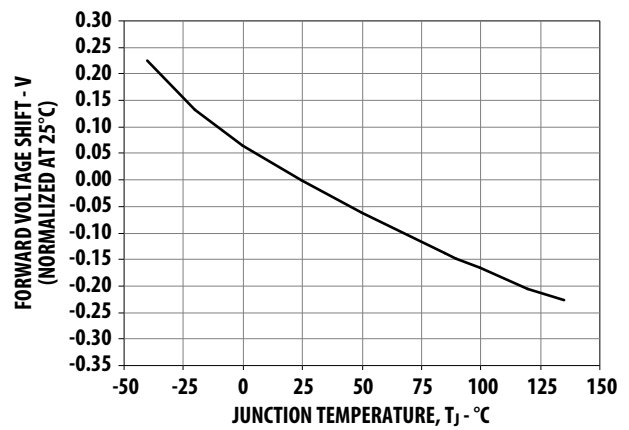

Figure 10. Forward Voltage Shift vs. Junction Temperature

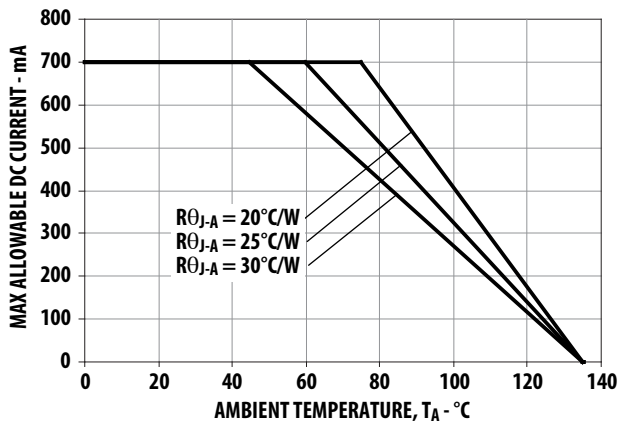

Figure 11. Maximum Forward Current vs. Ambient Temperature. Derated based on  $T_{JMAX} = 135^\circ\text{C}$ ,  $R_{\theta J-A} = 20^\circ\text{C/W}$ ,  $25^\circ\text{C/W}$  and  $30^\circ\text{C/W}$

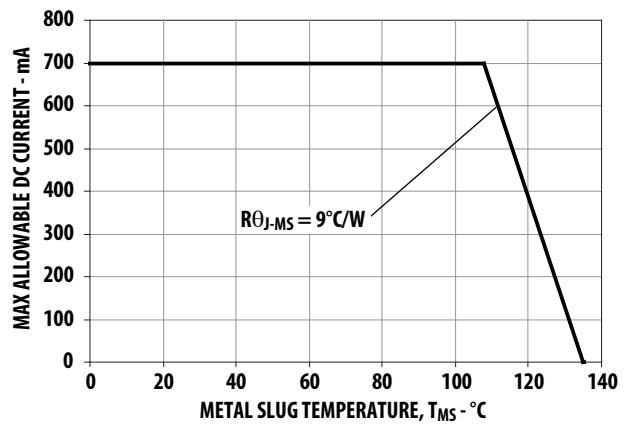

Figure 12. Maximum Forward Current vs. Metal Slug Temperature. Derated based on  $T_{JMAX} = 135^\circ\text{C}$ ,  $R_{\theta J-MS} = 9^\circ\text{C/W}$

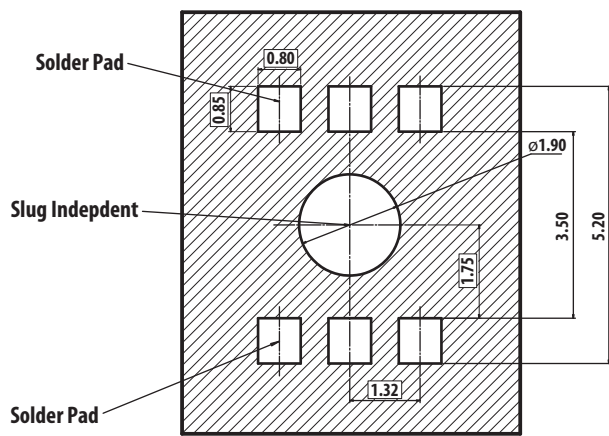

Figure 13. Recommended soldering land pattern

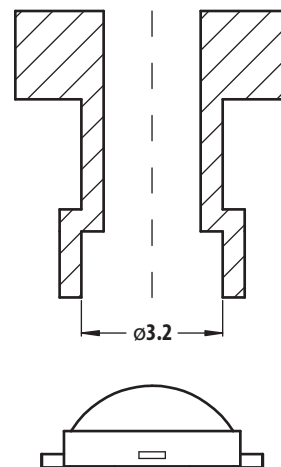

Figure 14. Recommended pick and place nozzle tip. Inner diameter = 3.2 mm

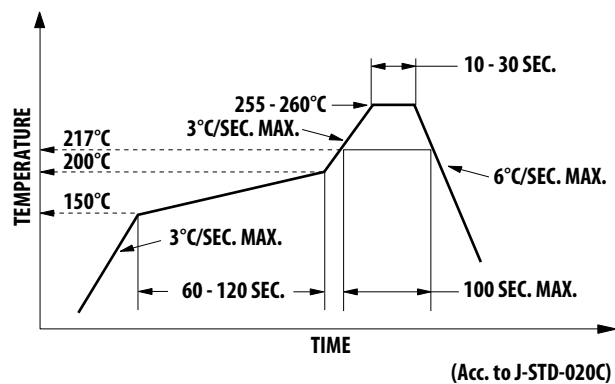

Figure 15. Recommended Reflow Soldering Profile

Note:

For detail information on reflow soldering of Avago surface mount LEDs, do refer to Avago Application Note AN1060 Surface Mounting SMT LED Indicator Components.

## Option Selection Details

### ASMT-J x<sub>1</sub> 3 2 – x<sub>2</sub> x<sub>3</sub> x<sub>4</sub> x<sub>5</sub> x<sub>6</sub>

x<sub>3</sub> – Minimum Flux Bin Selection

x<sub>4</sub> – Maximum Flux Bin Selection

x<sub>5</sub> – Color Bin Selection

x<sub>6</sub> – Packaging Option

## Flux Bin Limit [x<sub>3</sub>, x<sub>4</sub>]

Bin ID	Luminous Flux (lm) at 350 mA	
	Min.	Max.
T	67.2	87.4
U	87.4	99.6
V	99.6	113.6
W	113.6	129.5
X	129.5	147.7

## Color Bin Selection [x<sub>5</sub>]

Individual reel will contain parts from one color bin selection only.

### Cool White

Selection	Bin ID
0	Full Distribution
E	VM, UM, VN and UN
F	WM, VM, WN and VN
G	XM, WM, XN and WN
H	UN, VN, U0 and V0
J	WN, VN, W0 and V0
K	XN, WN, X0 and W0
L	V0, U0, VP and UP
M	W0, V0, WP, VP and WQ
N	X0, W0, XP, WP and WQ
P	Y0
Q	YA

### Warm White

Selection	Bin ID
0	Full Distribution
E	NM, MM, N1 and M1
F	PM, NM, P1 and N1
G	QM, PM, Q1 and P1
H	M1, N1, M0 and N0
J	P1, N1, P0 and N0
K	Q1, P1, Q0 and P0
L	N0, M0, NA and MA
M	P0, N0, PA and NA
N	Q0, P0, QA and PA

### Neutral White

Selection	Bin ID
0	Full Distribution
E	SM, RM, S1 and R1
F	TM, SM, TN and S1
G	S1, R1, S0 and R0
H	TN, S1, T0 and S0
J	S0, R0, SA and RA
K	T0, S0, TP and SA



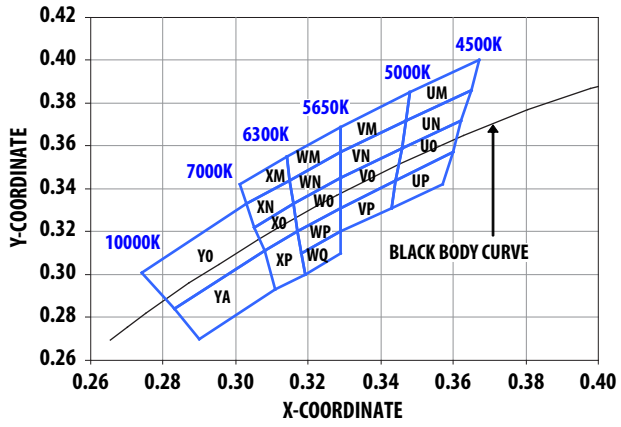

Figure 16. Color bin Structure for Cool White

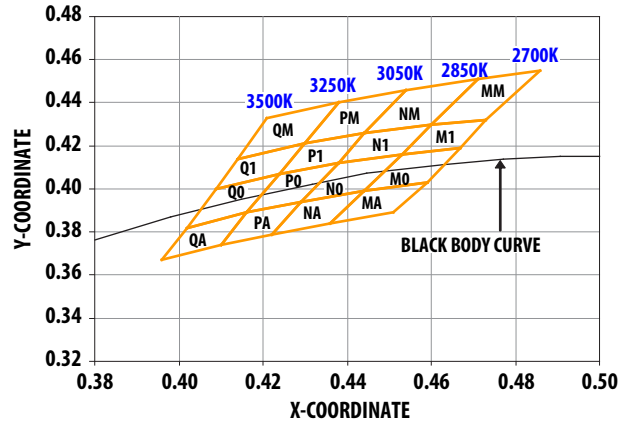

Figure 17. Color bin structure for Warm White

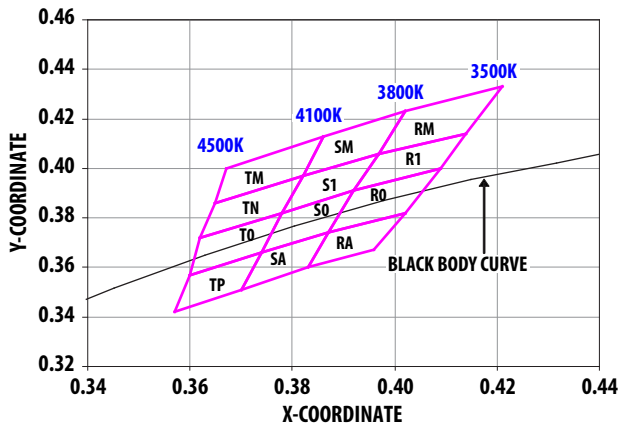

Figure 18. Color bin structure for Neutral White

## Color Bin Limits

Cool White	Color Limits (Chromaticity Coordinates)				
		x	y	z	w
Bin UM	x	0.365	0.367	0.348	0.347
	y	0.386	0.400	0.385	0.372
Bin UN	x	0.365	0.362	0.346	0.347
	y	0.386	0.372	0.359	0.372
Bin U0	x	0.362	0.360	0.344	0.346
	y	0.372	0.357	0.344	0.359
Bin UP	x	0.360	0.357	0.343	0.344
	y	0.357	0.342	0.331	0.344
Bin VM	x	0.329	0.329	0.348	0.347
	y	0.357	0.369	0.385	0.372
Bin VN	x	0.329	0.329	0.347	0.346
	y	0.345	0.357	0.372	0.359
Bin V0	x	0.329	0.329	0.346	0.344
	y	0.331	0.345	0.359	0.344
Bin VP	x	0.329	0.344	0.343	0.329
	y	0.331	0.344	0.331	0.320
Bin WM	x	0.329	0.329	0.315	0.314
	y	0.369	0.357	0.344	0.355
Bin WN	x	0.329	0.316	0.315	0.329
	y	0.345	0.333	0.344	0.357
Bin W0	x	0.329	0.329	0.317	0.316
	y	0.345	0.331	0.320	0.333
Bin WP	x	0.329	0.329	0.318	0.317
	y	0.331	0.320	0.310	0.320
Bin WQ	x	0.329	0.329	0.319	0.318
	y	0.320	0.310	0.300	0.310
Bin XM	x	0.301	0.314	0.315	0.303
	y	0.342	0.355	0.344	0.333
Bin XN	x	0.305	0.303	0.315	0.316
	y	0.322	0.333	0.344	0.333
Bin XO	x	0.308	0.305	0.316	0.317
	y	0.311	0.322	0.333	0.320
Bin XP	x	0.308	0.317	0.319	0.311
	y	0.311	0.320	0.300	0.293
Bin YO	x	0.308	0.283	0.274	0.303
	y	0.311	0.284	0.301	0.333
Bin YA	x	0.308	0.311	0.290	0.283
	y	0.311	0.293	0.270	0.284

Tolerance:  $\pm 0.01$

Warm White	Color Limits (Chromaticity Coordinates)				
		x	y	z	w
Bin MM	x	0.471	0.460	0.473	0.486
	y	0.451	0.430	0.432	0.455
Bin M1	x	0.460	0.453	0.467	0.473
	y	0.430	0.416	0.419	0.432
Bin M0	x	0.453	0.444	0.459	0.467
	y	0.416	0.399	0.403	0.419
Bin MA	x	0.459	0.444	0.436	0.451
	y	0.403	0.399	0.384	0.389
Bin NM	x	0.454	0.444	0.460	0.471
	y	0.446	0.426	0.430	0.451
Bin N1	x	0.444	0.438	0.453	0.460
	y	0.426	0.412	0.416	0.430
Bin N0	x	0.438	0.429	0.444	0.453
	y	0.412	0.394	0.399	0.416
Bin NA	x	0.444	0.429	0.422	0.436
	y	0.399	0.394	0.379	0.384
Bin PM	x	0.438	0.430	0.444	0.454
	y	0.440	0.421	0.426	0.446
Bin P1	x	0.430	0.424	0.438	0.444
	y	0.421	0.407	0.412	0.426
Bin P0	x	0.424	0.416	0.429	0.438
	y	0.407	0.389	0.394	0.412
Bin PA	x	0.429	0.416	0.410	0.422
	y	0.394	0.389	0.374	0.379
Bin QM	x	0.421	0.414	0.430	0.438
	y	0.433	0.414	0.421	0.440
Bin Q1	x	0.414	0.409	0.424	0.430
	y	0.414	0.400	0.407	0.421
Bin Q0	x	0.409	0.402	0.416	0.424
	y	0.400	0.382	0.389	0.407
Bin QA	x	0.416	0.402	0.396	0.410
	y	0.389	0.382	0.367	0.374

Tolerance:  $\pm 0.01$

Neutral White	Color Limits (Chromaticity Coordinates)				
		x	y	z	u
Bin RM	x	0.421	0.414	0.397	0.402
	y	0.433	0.414	0.406	0.423
Bin R1	x	0.414	0.409	0.392	0.397
	y	0.414	0.400	0.391	0.406
Bin R0	x	0.392	0.387	0.402	0.409
	y	0.391	0.374	0.382	0.400
Bin RA	x	0.387	0.383	0.396	0.402
	y	0.374	0.360	0.367	0.382
Bin SM	x	0.402	0.397	0.382	0.386
	y	0.423	0.406	0.397	0.413
Bin S1	x	0.397	0.392	0.378	0.382
	y	0.406	0.391	0.382	0.397
Bin S0	x	0.392	0.387	0.374	0.378
	y	0.391	0.374	0.366	0.382
Bin SA	x	0.387	0.383	0.370	0.374
	y	0.374	0.360	0.351	0.366
Bin TM	x	0.386	0.382	0.365	0.367
	y	0.413	0.397	0.386	0.400
Bin TN	x	0.382	0.378	0.362	0.365
	y	0.397	0.382	0.372	0.386
Bin T0	x	0.378	0.374	0.360	0.362
	y	0.382	0.366	0.357	0.372
Bin TP	x	0.374	0.370	0.357	0.360
	y	0.366	0.351	0.342	0.357

Tolerance:  $\pm 0.01$

### Packaging Option [x<sub>6</sub>]

Selection	Option
1	Tape and Reel

### Example

#### ASMT-JW32-NUV01

ASMT-JW32-Nxxxx – Cool White, InGaN,  
Electrically isolated Heat Sink

- X<sub>3</sub> = U – Minimum Flux Bin U
- X<sub>4</sub> = V – Maximum Flux Bin V
- X<sub>5</sub> = 0 – Full Distribution
- X<sub>6</sub> = 1 – Tape and Reel Option

### Tape and Reel – Option 1

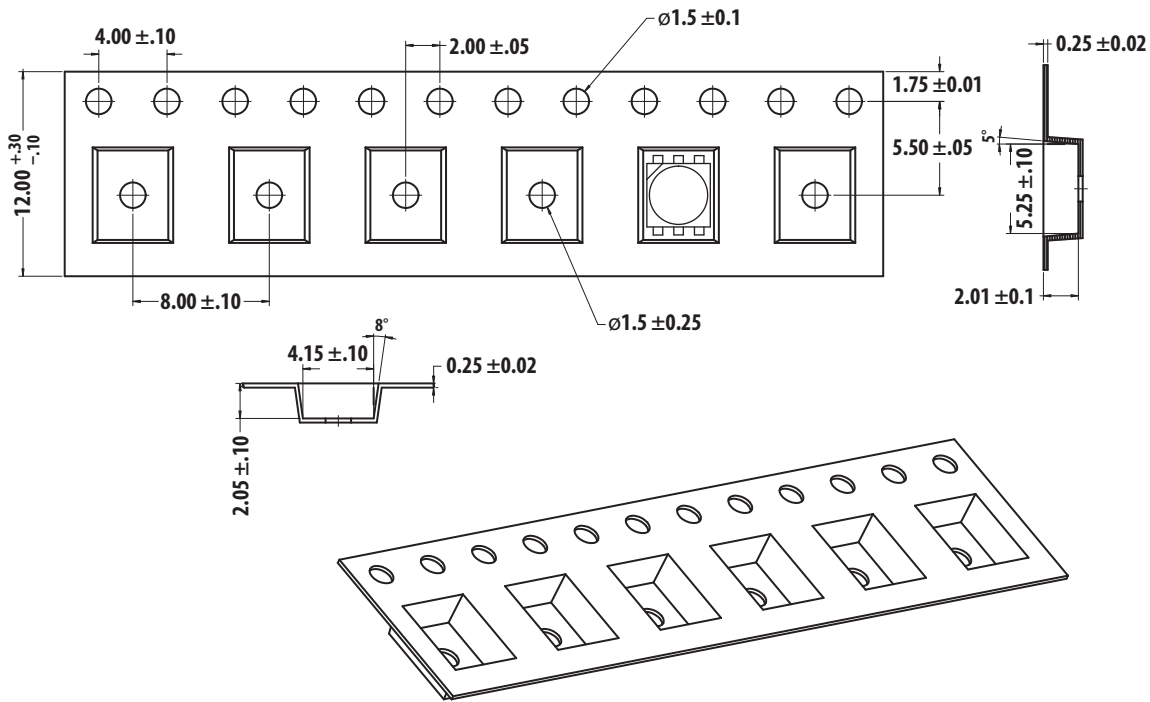
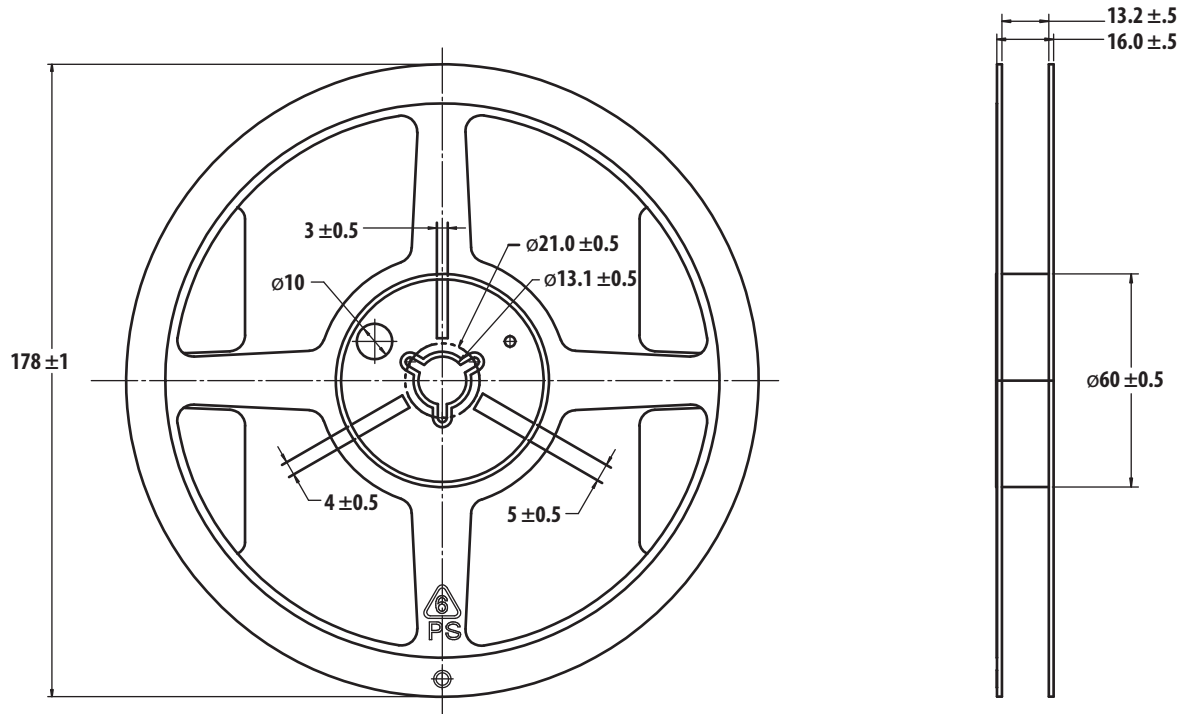

Figure 19. Carrier Tape Dimensions



Notes:

1. Empty component pockets sealed with top cover tape.
2. 250 or 500 pieces per reel.
3. Drawing not to scale.
4. All dimensions are in millimeters.

Figure 20. Reel dimensions

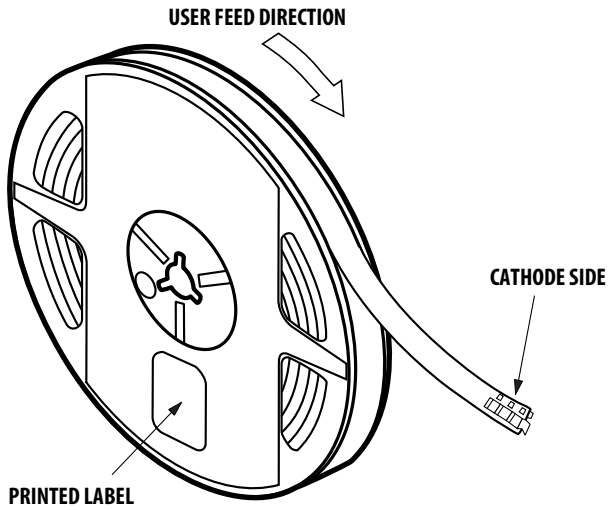

Figure 21. Reeling Orientation

**DISCLAIMER:** Avago's products and software are not specifically designed, manufactured or authorized for sale as parts, components or assemblies for the planning, construction, maintenance or direct operation of a nuclear facility or for use in medical devices or applications. Customer is solely responsible, and waives all rights to make claims against avago or its suppliers, for all loss, damage, expense or liability in connection with such use.

For product information and a complete list of distributors, please go to our web site: [www.avagotech.com](http://www.avagotech.com)

Avago, Avago Technologies, and the A logo are trademarks of Avago Technologies in the United States and other countries. Data subject to change. Copyright © 2005-2011 Avago Technologies. All rights reserved. AV02-2428EN - August 25, 2011

**Avago**  
TECHNOLOGIES