

BMA280 Shuttle Board

GENERAL DESCRIPTION

The Bosch Sensortec BMA280 shuttle-board is a PCB with a BMA280 acceleration sensor mounted on it. It allows easy access to the sensors pins via a simple socket. As all Bosch Sensortec sensor shuttle boards have identical footprint, they can be plugged into Bosch Sensortec's advanced development tools (e.g. the Development Board). Of course, the BMA280 shuttle board can also be used for customer's own implementations.

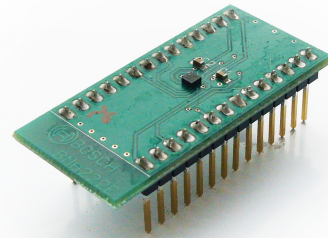

Note: Product photo may differ from real product's appearance.

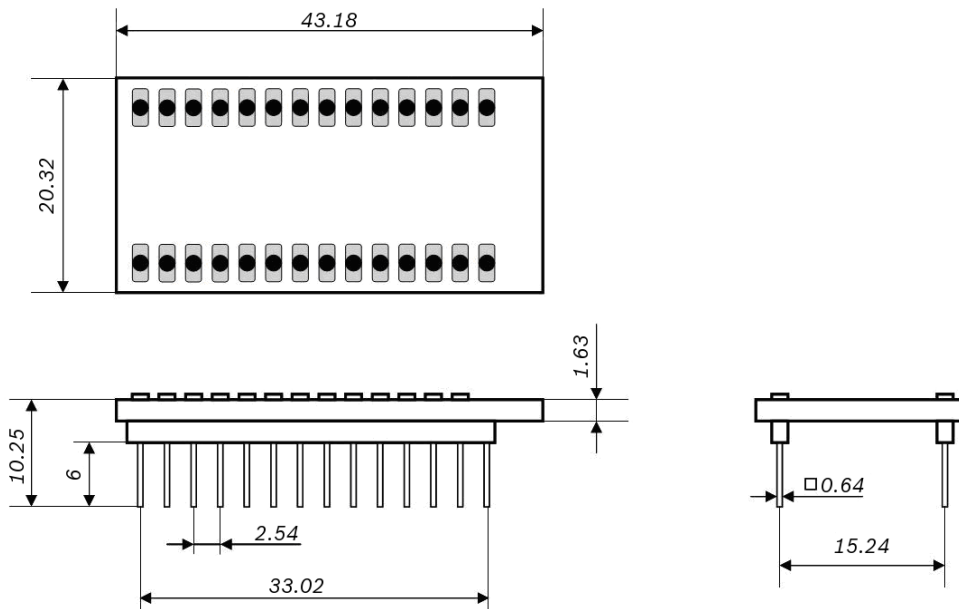

Shuttle board outline dimensions (all dimensions in mm)

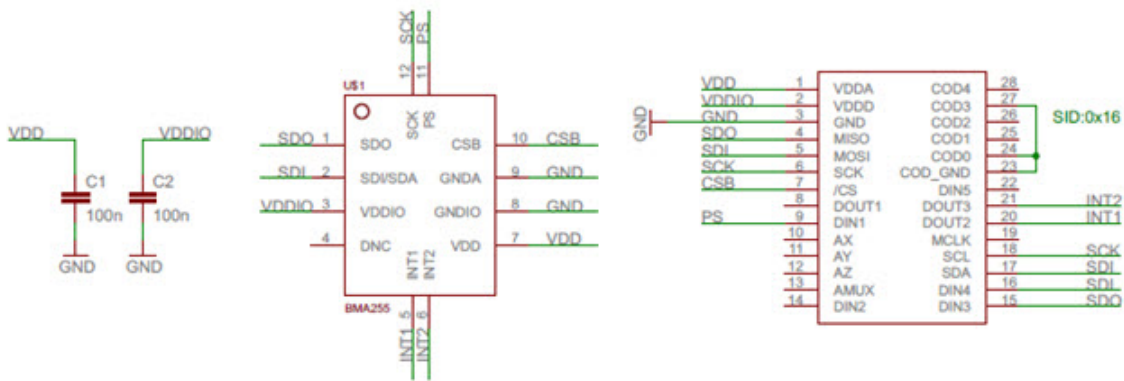

BMA280 shuttle board electrical layout

DELIVERABLES

- ▶ BMA280 shuttle board

Headquarters
Bosch Sensortec GmbH

Gerhard-Kindler-Strasse 9
72770 Reutlingen · Germany
Telephone +49 7121 3535 900
Fax +49 7121 3535 909

www.bosch-sensortec.com