

User Manual

EKI-5000 Series

ProView Series Ethernet Switches

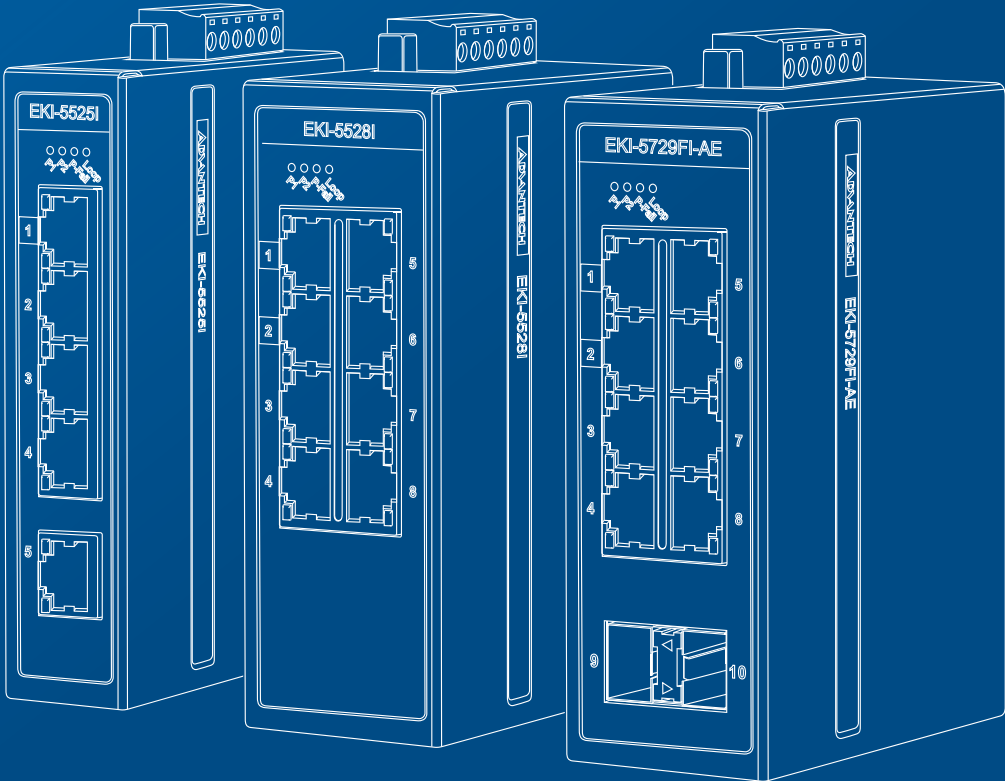

P/N: 2015-EKI-5000-01
Version: Edition 4 , 2015/06



Enabling an Intelligent Planet

Content

Chapter 1 Product Overview

1.1.	Supported Models	1
1.2.	Specifications	2
1.3.	Hardware Views	8
1.3.1	Front View.....	8
1.3.2	Rear View	24
1.3.3	Top View.....	28
1.3.4	Bottom View.....	31
1.4.	Packing List	33

Chapter 2 Switch Installation

2.1.	Installation Guidelines	35
2.1.1	Connecting Hardware.....	35
2.2.	Verifying Switch Operation	35
2.3.	Installing the Switch.	36
2.3.1	DIN Rail Mounting.....	36
2.3.2	Wall-Mounting.....	37
2.4.	Installing and Removing SFP Modules	39
2.4.1	Installing SFP Modules.....	40
2.4.2	Removing SFP Modules.....	41
2.5.	Connecting the Switch to Ethernet Ports.	42
2.5.1	RJ45 Ethernet Cable Wiring.....	42
2.6.	Power Supply Installation	43
2.6.1	Overview.....	43
2.6.2	Considerations.....	43
2.6.3	Grounding the Device.....	44
2.6.4	Wiring a Relay Contact.....	45
2.6.5	Wiring the Power Inputs.....	45

Chapter 3 Configuration Utility

3.1.	Overview	49
3.2.	Enabling ProView Function	49
3.3.	Installing the Configuration Utility	50

3.4.	Utility Menu Map	53
3.5.	Menu Bar	54
	3.5.1 View Menu	54
	3.5.2 Management Menu	56
	3.5.3 Help Menu	56
3.6.	Tool Bar	57
3.7.	TreeView	57
3.8.	Information Panel	57
3.9.	Status Bar	57
3.10.	Configuration Area.	57

Chapter 4 Managing Switch

4.1.	Discovering Switches	59
	4.1.1 First Time Installation	59
	4.1.2 Discovering Switches	61
	4.1.3 Group Management	62
	4.1.4 Configuring the System	67
4.2.	Modbus/TCP Mapping	70
	4.2.1 Modbus/TCP Mapping Table	71

Federal Communication Commission Interference Statement

For further certification information, please go to www.advantech.com

Declaration of Conformity

CE

This product has passed the CE test for environmental specifications when shielded cables are used for external wiring. We recommend the use of shielded cables. This kind of cable is available from Advantech. Please contact your local supplier for ordering information.

This product has passed the CE test for environmental specifications. Test conditions for passing included the equipment being operated within an industrial enclosure. In order to protect the product from being damaged by ESD (Electrostatic Discharge) and EMI leakage, we strongly recommend the use of CE-compliant industrial enclosure products.

FCC Class A

This equipment has been tested and found to comply with the limits for a Class A digital device, pursuant to part 15 of the FCC Rules. These limits are designed to provide reasonable protection against harmful interference when the equipment is operated in a commercial environment. This equipment generates, uses, and can radiate radio frequency energy and, if not installed and used in accordance with the instruction manual, may cause harmful interference to radio communications. Operation of this equipment in a residential area is likely to cause harmful interference in which case the user will be required to correct the interference at his own expense.

Warnings for Class 1 Division 2

The following statements are required to appear for Class 1 Division 2 requirements

These devices are open-type devices that are to be installed in an enclosure with tool removable cover/door that is suitable for the environment.

WARNING - This equipment is suitable for use in Class I, Division 2, Groups A, B, C, and D or non-hazardous locations only.

WARNING - EXPLOSION HAZARD - Do not connect or disconnect equipment unless power has been removed or the area is known to be non-hazardous."

WARNING - EXPLOSION HAZARD - Substitution of any components may impair suitability for Class I, Division 2."

AVERTISSEMENT - Ce équipement est adapté à une utilisation en Classe I, Division 2, Groupes A, B, C, et D ou non dangereux.

AVERTISSEMENT - RISQUE D'EXPLOSION - Ne pas brancher ou débrancher l'équipement que l'alimentation a été retiré ou la région est connue pour être non dangereux ".

AVERTISSEMENT - RISQUE D'EXPLOSION - Remplacement de tous les composants peut nuire à la conformité de Classe I, Division 2."

ATEX Information

ATEX Directive 94/9/EC (as amended relating to Group II, Category 3 locations)



Standard: EN 60079-0:2012+A11:2013; EN 60079-15:2010

Conditions of safe use:

- The equipment shall only be used in an area of not more than pollution degree 2, as defined in IEC 60664-1.
- The equipment shall be installed in an enclosure that provides a degree of protection not less than IP 54 in accordance with EN 60079-15 and accessible only by the use of a tool.
- Transient protection shall be provided that is set at a level not exceeding 140 % of the peak rated voltage value at the supply terminals to the equipment.

Safety Instructions

- Read these safety instructions carefully.
- Keep this user manual for later reference.
- Disconnect this equipment from any AC outlet before cleaning. Use damp cloth. Do not use liquid or spray detergents for cleaning.
- For plug-in equipment, the power outlet socket must be located near the equipment and must be easily accessible.
- Keep this equipment away from humidity.
- Put this equipment on a reliable surface during installation. Dropping it or letting it fall may cause damage.
- The openings on the enclosure are for air convection. Protect the equipment from overheating. **DO NOT COVER THE OPENINGS.**
- Make sure the voltage of the power source is correct before connecting the equipment to the power outlet.
- Position the power cord so that people cannot step on it. Do not place anything over the power cord.
- All cautions and warning on the equipment should be noted.
- If the equipment is not used for a long time, disconnect it from the power source to avoid damage by transient over voltage.
- Never pour any liquid into an opening. This may cause fire or electrical shock.
- Never open the equipment. For safety reasons, the equipment should be opened only by qualified service personnel.

- If one of the following situations arises, get the equipment checked by service personnel:
 - The power cord or plug is damaged.
 - Liquid has peretrated into the equipment.
 - The equipment has been exposed to moisture.
 - The equipment does not work well, or you cannot get it to work according to the user manual
 - The equipment has been dropped and damaged.
 - The equipment has obvious signs of breakage.
- Instructions for installation in a pollution Degree 2 environment or equivalent statement.
- PoE requirements:
This product was in-door used and not connected to outside plant, so user manual shall have the description as below or equivalent: “The equipment is to be connected only to PoE networks without routing to the outside plant.”
- Do NOT LEAVE THIS EQUIPMENT IN AN ENVIRONMENT WHERE THE STORAGE TEMPERATURE MAY GO BELOW -40°C(-40°F) OR ABOVE 75°C(167°F) THIS COULD DAMAGE THE EQUIPMENT. THE EQUIPMENT SHOULD BE IN A CONTROLLED ENVIRONMENT.

Product Warranty (5 years)

Company Address:

ADVANTECH CO.,LTD. (研華股份有限公司)

1 ALY 20 LN 26 RUEIGUANG RD NEIHU DISTRICT TAIPEI 114 TAIWAN

Advantech warrants to you, the original purchaser, that each of its products will be free from defects in materials and workmanship for five years from the date of purchase.

This warranty does not apply to any products which have been repaired or altered by persons other than repair personnel authorized by Advantech, or which have been subject to misuse, abuse, accident or improper installation. Advantech assumes no liability under the terms of this warranty as a consequence of such events.

Because of Advantech’s high quality-control standards and rigorous testing, most of our customers never need to use our repair service. If an Advantech product is defective, it will be repaired or replaced at no charge during the warranty period. For out of-warranty repairs, you will be billed according to the cost of replacement materials, service time and freight. Please consult your dealer for more details.

If you think you have a defective product, follow these steps:

1. Collect all the information about the problem encountered. (For example, CPU speed, Advantech products used, other hardware and software used, etc.) Note anything abnormal and list any on screen messages you get when the problem occurs.
2. Call your dealer and describe the problem. Please have your manual, product, and any helpful information readily available.

-
3. If your product is diagnosed as defective, obtain an RMA (return merchandise authorization) number from your dealer. This allows us to process your return more quickly.
 4. Carefully pack the defective product, a fully-completed Repair and Replacement Order Card and a photocopy proof of purchase date (such as your sales receipt) in a shippable container. A product returned without proof of the purchase date is not eligible for warranty service.
 5. Write the RMA number visibly on the outside of the package and ship it prepaid to your dealer.

Conventions



Warning signs are used to identify immediate hazards for property damage, injury or death.



CAUTION SIGNS ARE USED TO WARN AGAINST POTENTIAL HAZARDS OR TO CAUTION AGAINST UNSAFE PRACTICES.



Note signs are used to provide additional information for the device or settings.

Copyright

Copyright © 2015 Advantech Inc. All rights reserved. No part of this publication may be reproduced, adapted, stored in a retrieval system, translated into any language, or transmitted in any form or by any means without the written permission of the manufacturer.

Technical Support and Assistance

1. Visit the Advantech web site at www.advantech.com/support where you can find the latest information about the product.
2. Contract your distributor, sales representative, or Advantech's customer service center for technical support if you need additional assistance. Please have the following information ready before you call:
 - Product name and serial number
 - Description of your peripheral attachment
 - Description of your software (operating system, version, application software, etc.)
 - A complete description of the problem
 - The exact wording of any error messages

Regional Service & Customization Centers

China Kunshan 86-512-5777-5666	Taiwan Taipei 886-2-2792-7818	Netherlands Eindhoven 31-40-267-7000	Poland Warsaw 48-22-33-23-740 / 41	USA/ Canada Milpitas, CA 1-408-519-3898
---	--	---	---	--

Worldwide Offices

Greater China

China	
Toll Free	800-810-0345
Beijing	86-10-6298-4346
Shanghai	86-21-3632-1616
Shenzhen	86-755-8212-4222
Chengdu	86-28-8545-0198
Hong Kong	852-2720-5118
Taiwan	
Toll Free	0800-777-111
Neihu	886-2-2792-7818
Xindian	886-2-2218-4567
Taichung	886-4-2378-6250
Kaohsiung	886-7-229-3600

Asia Pacific

Japan	
Toll Free	0800-500-1055
Tokyo	81-3-6802-1021
Osaka	81-6-6267-1887
Korea	
Toll Free	080-363-9494
Seoul	82-2-3663-9494
Singapore	
Singapore	65-6442-1000
Malaysia	
Toll Free	1800-88-1809
Kuala Lumpur	60-3-7725-4188
Penang	60-4-537-9188
Indonesia	
Jakarta	62-21-769-0525
Thailand	
Bangkok	66-2-248-3140
India	
Toll Free	1-800-425-5070
Pune	91-20-39482075
Bangalore	91-80-2545-0206
Australia	
Toll Free	1300-308-531
Melbourne	61-3-9797-0100
Sydney	61-2-9476-9300

Europe

Toll Free	00800-2426-8080
Germany	
Munich	49-89-12599-0
Hilden / D'dorf	49-2103-97-885-0
France	
Paris	33-1-4119-4666
Italy	
Milano	39-02-9544-961
Benelux & Nordics	
Breda	31-76-5233-100
UK	
Reading	44-0118-929-4540
Poland	
Warsaw	48-22-33-23-740 / 41
Russia	
Toll Free	8-800-550-01-50
Moscow	7-495-232-1692

Americas

North America	
Toll Free	1-888-576-9668
Cincinnati	1-513-742-8895
Milpitas	1-408-519-3898
Irvine	1-949-420-2500
Brazil	
Toll Free	0800-770-5355
Saude-São Paulo	55-11-5592-5355
Mexico	
Toll Free	1-800-467-2415
Mexico City	52-55-6275-2777

About This Manual

This user manual is intended to guide professional installers in installing and configuring the ProView Series Ethernet Switches. It includes technical specifications, software utility introduction, as well as procedures for the use of the software utility to self-manage the devices.

Product Overview

Chapter 1

1.1. Supported Models

Standard Models:

Table 1-1. Standard Models

EKI-5525S	EKI-5525M	EKI-5525S-ST
EKI-5525M-ST	EKI-5524SS	EKI-5524MM
EKI-5524SS-ST	EKI-5524MM-ST	EKI-5525
EKI-5725	EKI-5728	EKI-5729F
EKI-5725FP	EKI-5528	EKI-5526
EKI-5726	EKI-5726F	EKI-5629C
EKI-5626C	EKI-5624P	EKI-5729P

Wide Temperature Models:

Table 1-2. Wide Temperature Models

EKI-5525SI	EKI-5525MI	EKI-5525SI-ST
EKI-5525MI-ST	EKI-5524SSI	EKI-5524MMI
EKI-5524SSI-ST	EKI-5524MMI-ST	EKI-5525I
EKI-5725I	EKI-5728I	EKI-5729FI
EKI-5725FPI	EKI-5528I	EKI-5526I
EKI-5726I	EKI-5726FI	EKI-5629CI
EKI-5626CI	EKI-5624PI	EKI-5729PI

1.2. Specifications

Table 1-3. Specifications

Specifications	Description	
Interface	I/O Port	<ul style="list-style-type: none"> • EKI-5525S/EKI-5525SI: 4 x RJ45 + 1 x SC (single mode) • EKI-5525M/EKI-5525MI: 4 x RJ45 + 1 x SC (multi mode) • EKI-5525S-ST/EKI-5525SI-ST: 4 x RJ45 + 1 x ST (single mode) • EKI-5525M-ST/EKI-5525MI-ST: 4 x RJ45 + 1 x ST (multi mode) • EKI-5524SS/EKI-5524SSI: 4 x RJ45 + 2 x SC (single mode) • EKI-5524MM/EKI-5524MMI: 4 x RJ45 + 2 x SC (multi mode) • EKI-5524SS-ST/EKI-5524SSI-ST: 4 x RJ45 + 2 x ST (single mode) • EKI-5524MM-ST/EKI-5524MMI-ST: 4 x RJ45 + 2 x ST (multi mode) • EKI-5525/EKI-5525I: 5 x 10/100BaseT(X) • EKI-5725/EKI-5725I: 5 x 10/100/1000BaseT(X) • EKI-5728/EKI-5728I: 8 x 10/100/1000BaseT(X) • EKI-5729F/EKI-5729FI: 8 x 10/100/1000BaseT(X) + 2 x 100/1000Base-FX SFP • EKI-5725FP/EKI-5725FPI: 4 x 10/100/1000BaseT(X) with PoE + 1 x 100/1000Base-FX SFP • EKI-5528/EKI-5528I: 8 x 10/100BaseT(X) • EKI-5526/EKI-5526I: 16 x 10/100BaseT(X) • EKI-5726/EKI-5726I: 16 x 10/100/1000BaseT(X) • EKI-5726F/EKI-5726FI: 16 x 10/100/1000BaseT(X) + 2 x 100/1000Base-FX SFP • EKI-5629C/EKI-5629CI: 8 x 10/100BaseT(X) + 2 x 10/100/1000Base-T(X) or 100/1000Base-FX SFP • EKI-5626C/EKI-5626CI: 16 x 10/100BaseT(X) + 2 x 10/100/1000Base-T(X) or 100/1000Base-FX SFP • EKI-5624P/EKI-5624PI: 4 x 10/100BaseT(X) with PoE + 2 x 10/100/1000BaseT(X) • EKI-5729P/EKI-5729PI: 8 x 10/100/1000BaseT(X) with PoE + 2 x 10/100/1000BaseT(X)
	Power Connector	6-pin screw Terminal Block (including relay)

Table 1-3. Specifications (Continued)

Specifications	Description	
Physical	Enclosure	Metal Shell
	Protection Class	IP30
	Installation	DIN-Rail and Wall-Mount
	Dimensions (W x H x D)	<ul style="list-style-type: none"> • EKI-5525S/EKI-5525SI: 27mm x 120mm x 84mm • EKI-5525M/EKI-5525MI: 27mm x 120mm x 84mm • EKI-5525S-ST/EKI-5525SI-ST: 27mm x 120mm x 84mm • EKI-5525M-ST/EKI-5525MI-ST: 27mm x 120mm x 84mm • EKI-5524SS: 28.5mm x 120mm x 85.3mm • EKI-5524SSI: 28.5mm x 120mm x 85.3mm • EKI-5524MM/EKI-5524MMI: 28.5mm x 120mm x 85.3mm • EKI-5524SS-ST/EKI-5524SSI-ST: 28.5mm x 120mm x 85.3mm • EKI-5524MM-ST/EKI-5524MMI-ST: 28.5mm x 120mm x 85.3mm • EKI-5525/EKI-5525I: 27mm x 120mm x 84mm • EKI-5725/EKI-5725I: 27mm x 120mm x 84mm • EKI-5728/EKI-5728I: 43mm x 120mm x 84mm • EKI-5729F/EKI-5729FI: 43mm x 120mm x 84mm • EKI-5725FP/EKI-5725FPI: 74mm x 152mm x 105mm • EKI-5528/EKI-5528I: 43mm x 120mm x 84mm • EKI-5526/EKI-5526I: 74mm x 120mm x 84mm • EKI-5726/EKI-5726I: 74mm x 120mm x 84mm • EKI-5726F/EKI-5726FI: 74mm x 120mm x 84mm • EKI-5629C/EKI-5629CI: 74mm x 120mm x 84mm • EKI-5626C/EKI-5626CI: 74mm x 120mm x 84mm • EKI-5624P/EKI-5624PI: 74mm x 152mm x 105mm • EKI-5729P/EKI-5729PI: 74mm x 152mm x 105mm
LED Display	System LED	PWR1, PWR2, P-Fail, Loop detection PoE (only for EKI-5725FP/EKI-5725FPI)
	Port LED	Link / Speed / Activity PoE (only for EKI-5725FP/EKI-5725FPI, EKI-5624P/ EKI-5624PI and EKI-5729P/EKI-5729PI)

Table 1-3. Specifications (Continued)

Specifications	Description	
Environment	Operating Temperature	<ul style="list-style-type: none"> ● Wide Temperature: -40°C ~ 75°C (-40°F ~ 167°F) ● Standard Temperature: <ul style="list-style-type: none"> ● Non PoE Models: -10°C ~ 60°C (14°F ~ 140°F) ● PoE Models: -25°C ~ 60°C(-4°F ~ 140°F)
	Storage Temperature	-40°C ~ 85° C (-40°F ~ 185° F)
	Ambient Relative Humidity	10 ~ 95% (non-condensing)
Switch Properties	MAC Address	<ul style="list-style-type: none"> ● EKI-5525S/EKI-5525SI: 2K entries ● EKI-5525M/EKI-5525MI: 2K entries ● EKI-5525S-ST/EKI-5525SI-ST: 2K entries ● EKI-5525M-ST/EKI-5525MI-ST: 2K entries ● EKI-5524SS/EKI-5524SSI: 2K entries ● EKI-5524MM/EKI-5524MMI: 2K entries ● EKI-5524SS-ST/EKI-5524SSI-ST: 2K entries ● EKI-5524MM-ST/EKI-5524MMI-ST: 2K entries ● EKI-5525/EKI-5525I: 2K entries ● EKI-5725/EKI-5725I: 2K entries ● EKI-5728/EKI-5728I: 8K entries ● EKI-5729F/EKI-5729FI: 8K entries ● EKI-5725FP/EKI-5725FPI: 2K entries ● EKI-5528/EKI-5528I: 8K entries ● EKI-5526/EKI-5526I: 8K entries ● EKI-5726/EKI-5726I: 8K entries ● EKI-5726F/EKI-5726FI: 8K entries ● EKI-5629C/EKI-5629CI: 8K entries ● EKI-5626C/EKI-5626CI: 8K entries ● EKI-5624P/EKI-5624PI: 2K entries ● EKI-5729P/EKI-5729PI: 8K entries

Table 1-3. Specifications (Continued)

Specifications	Description	
Switch Properties	Switching Bandwidth	<ul style="list-style-type: none"> ● EKI-5525S/EKI-5525SI: 1 Gbps ● EKI-5525M/EKI-5525MI: 1 Gbps ● EKI-5525S-ST/EKI-5525SI-ST: 1 Gbps ● EKI-5525M-ST/EKI-5525MI-ST: 1 Gbps ● EKI-5524SS/EKI-5524SSI: 1.2 Gbps ● EKI-5524MM/EKI-5524MMI: 1.2 Gbps ● EKI-5524SS-ST/EKI-5524SSI-ST: 1.2 Gbps ● EKI-5524MM-ST/EKI-5524MMI-ST: 1.2 Gbps ● EKI-5525/EKI-5525I: 1 Gbps ● EKI-5725/EKI-5725I: 10 Gbps ● EKI-5728/EKI-5728I: 16 Gbps ● EKI-5729F/EKI-5729FI: 20 Gbps ● EKI-5725FP/EKI-5725FPI: 10 Gbps ● EKI-5528/EKI-5528I: 1.6 Gbps ● EKI-5526/EKI-5526I: 3.2 Gbps ● EKI-5726/EKI-5726I: 32 Gbps ● EKI-5726F/EKI-5726FI: 36 Gbps ● EKI-5629C/EKI-5629CI: 5.6 Gbps ● EKI-5626C/EKI-5626CI: 7.2 Gbps ● EKI-5624P/EKI-5624PI: 4.8Gbps ● EKI-5729P/EKI-5729PI: 20Gbps

Table 1-3. Specifications (Continued)

Specifications	Description	
Power	Power Consumption	<ul style="list-style-type: none"> ● EKI-5525S/EKI-5525SI: 2.8 watts ● EKI-5525M/EKI-5525MI: 2.8 watts ● EKI-5525S-ST/EKI-5525SI-ST: 2.8 watts ● EKI-5525M-ST/EKI-5525MI-ST: 2.8 watts ● EKI-5524SS/EKI-5524SSI: 4 watts ● EKI-5524MM/EKI-5524MMI: 4 watts ● EKI-5524SS-ST/EKI-5524SSI-ST: 4 watts ● EKI-5524MM-ST/EKI-5524MMI-ST: 4 watts ● EKI-5525/EKI-5525I: 2 watts ● EKI-5725/EKI-5725I: 2 watts ● EKI-5728/EKI-5728I: 5.2 watts ● EKI-5729F/EKI-5729FI: 6.8 watts ● EKI-5725FP/EKI-5725FPI: 89 watts ● EKI-5528/EKI-5528I: 3.6 watts ● EKI-5526/EKI-5526I: 3.84 watts ● EKI-5726/EKI-5726I: 8 watts ● EKI-5726F/EKI-5726FI: 9.6 watts ● EKI-5629C/EKI-5629CI: 5.8 watts ● EKI-5626C/EKI-5626CI: 8.2 watts ● EKI-5624P/EKI-5624PI: 60 watts ● EKI-5729P/EKI-5729PI: 65 watts
	Power Input	<ul style="list-style-type: none"> ● 12V ~ 48V (8.4V ~ 52.8V), redundant dual inputs ● 24V ~ 48V (16.8V ~ 62.4V): only for EKI-5725FP/EKI-5725FPI ● 12V ~ 24V (9V ~ 36V): only for EKI-5624P/EKI-5624PI and EKI-5729P/EKI-5729PI

Table 1-3. Specifications (Continued)

Specifications	Description	
Certifications	Safety	<ul style="list-style-type: none"> ● IEC/EN 60950-1, UL508 ● UL61010-1+UL61010-2-201 (Only for EKI-5729P/EKI-5729PI, EKI-5624P/EKI-5624PI and EKI-5725FP/EKI-5725FPI) ● Class 1 Division 2, IECEx , ATEX
	EMC	<ul style="list-style-type: none"> ● CE, FCC ● e-Mark (Only for EKI-5728/EKI-5728I, EKI-5729F, EKI-5729FI)
	EMI	EN 55011/ 55022 Class A, EN 61000-6-4, FCC Part 15 Subpart B Class A
	EMS	<ul style="list-style-type: none"> ● EN 55024/ EN 61000-6-2 ● EN 61000-4-2 (ESD) Level 3 ● EN 61000-4-3 (RS) Level 3; ● EN 61000-4-4 (EFT) Level 3 ● EN 61000-4-5 (Surge) Level 3; ● EN 61000-4-6 (CS) Level 3 ● EN 61000-4-8 (Magnetic Field) Level 3
	Shock	IEC 60068-2-27
	Freefall	IEC 60068-2-32
	Vibration	IEC 60068-2-6

1.3. Hardware Views

1.3.1 Front View

The following view applies to EKI-5525, EKI-5525I, EKI-5725 and EKI-5725I.

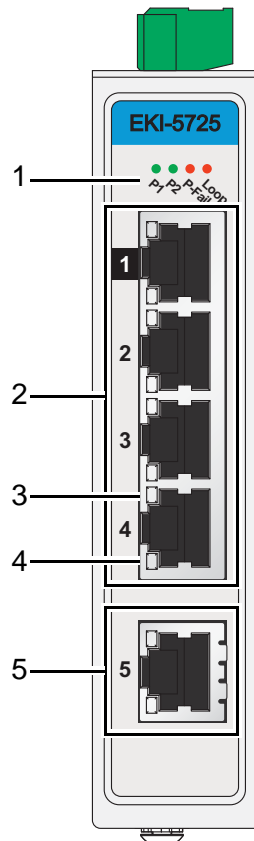

Figure 1-1. Front View

Table 1-4. Front View

No.	Item	Description
1	System LED panel	See "System LED Panel" on page 22 for further details.
2	ETH port	EKI-5525/EKI-5525I: Four 10/100BaseT(X) ports. EKI-5725/EKI-5725I: Four 10/100/1000BaseT(X) ports. Port numbers in black are designated for port based Quality of Service (QoS) functionality.
3	LNK/ACT LED	Link activity LED.

Table 1-4. Front View (Continued)

No.	Item	Description
4	Speed LED	<ul style="list-style-type: none"> Gigabit Ethernet: <ul style="list-style-type: none"> Green: 1000M Amber: 100M Off: 10M Fast Ethernet: <ul style="list-style-type: none"> Amber: 100M Off: 10M
5	ETH port	EKI-5525/EKI-5525I: One 10/100BaseT(X) port. EKI-5725/EKI-5725I: One 10/100/1000BaseT(X) port.

The following view applies to EKI-5528, EKI-5528I, EKI-5728 and EKI-5728I.

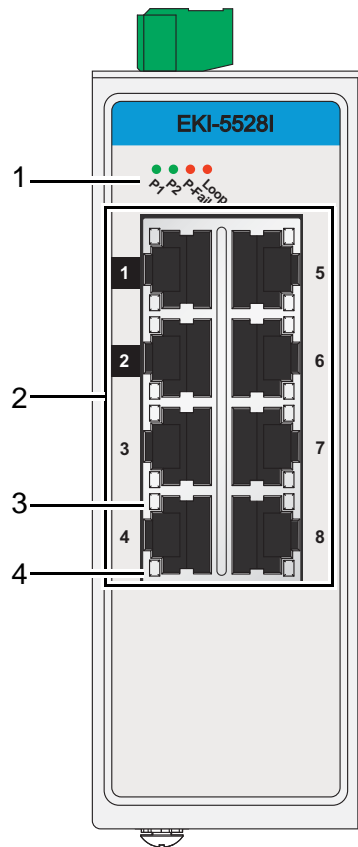

Figure 1-2. Front View

Table 1-5. Front View

No.	Item	Description
1	System LED panel	See "System LED Panel" on page 22 for further details.

Table 1-5. Front View (Continued)

No.	Item	Description
2	ETH port	EKI-5528/EKI-5528I: Eight 10/100BaseT(X) ports. EKI-5728/EKI-5728I: Eight 10/100/1000BaseT(X) ports. Port numbers in black are designated for port based Quality of Service (QoS) functionality.
3	LNK/ACT LED	Link activity LED.
4	Speed LED	<ul style="list-style-type: none"> • Gigabit Ethernet: <ul style="list-style-type: none"> • Green: 1000M • Amber: 100M • Off: 10M • Fast Ethernet: <ul style="list-style-type: none"> • Amber: 100M • Off: 10M

The following view applies to EKI-5729F and EKI-5729FI.

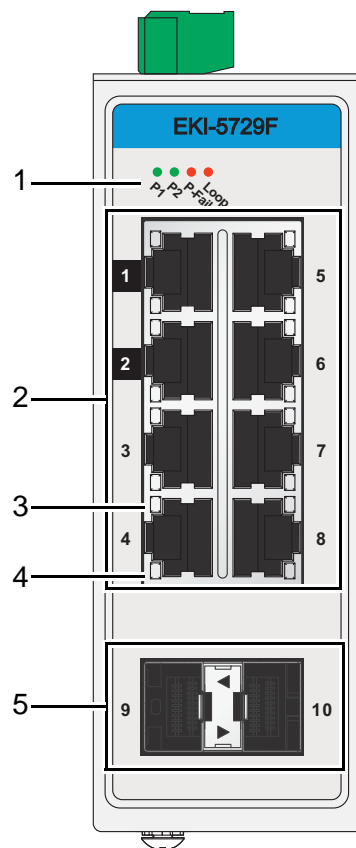

Figure 1-3. Front View

Table 1-6. Front View

No.	Item	Description
1	System LED panel	See "System LED Panel" on page 22 for further details.

Table 1-6. Front View (Continued)

No.	Item	Description
2	ETH port	Eight 10/100/1000BaseT(X) ports. Port numbers in black are designated for port based Quality of Service (QoS) functionality.
3	LNK/ACT LED	Link activity LED.
4	Speed LED	Gigabit Ethernet: <ul style="list-style-type: none"> • Green: 1000M • Amber: 100M • Off: 10M
5	ETH port	Two 100/1000Base-FX SFP ports.

The following view applies to EKI-5525S, EKI-5525SI, EKI-5525M and EKI-5525MI.

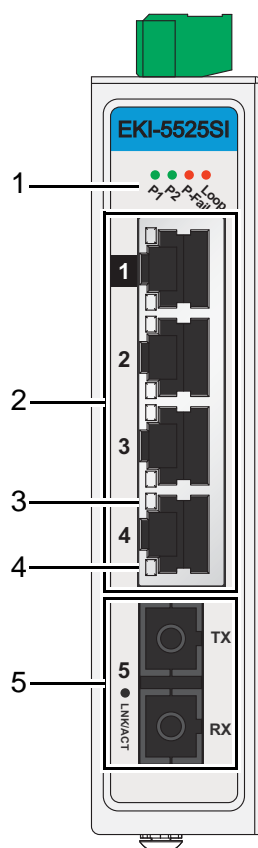

Figure 1-4. Front View

Table 1-7. Front View

No.	Item	Description
1	System LED panel	See “System LED Panel” on page 22 for further details.
2	ETH port	Four RJ45 ports. Port numbers in black are designated for port based Quality of Service (QoS) functionality.

Table 1-7. Front View (Continued)

No.	Item	Description
3	LNK/ACT LED	Link activity LED.
4	Speed LED	Fast Ethernet: <ul style="list-style-type: none"> • Amber: 100M • Off: 10M
5	SC port	EKI-5525S/EKI-5525SI: One SC (single mode) port EKI-5525M/EKI-5525MI: One SC (multi mode) port

The following view applies to EKI-5525S-ST, EKI-5525SI-ST, EKI-5525M-ST and EKI-5525MI-ST.

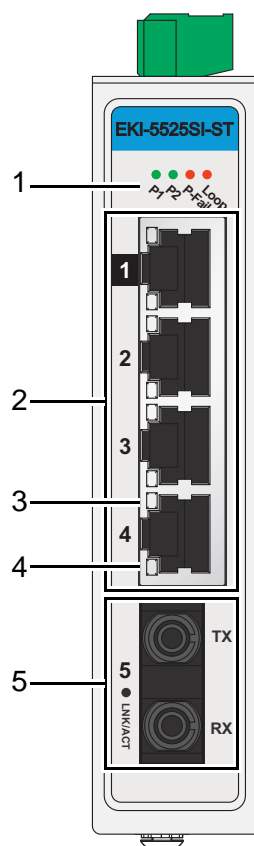

Figure 1-5. Front View

Table 1-8. Front View

No.	Item	Description
1	System LED panel	See “System LED Panel” on page 22 for further details.
2	ETH port	Four RJ45 ports. Port numbers in black are designated for port based Quality of Service (QoS) functionality.
3	LNK/ACT LED	Link activity LED.

Table 1-8. Front View (Continued)

No.	Item	Description
4	Speed LED	Fast Ethernet: <ul style="list-style-type: none"> • Amber: 100M • Off: 10M
5	ST port	EKI-5525S-ST/EKI-5525SI-ST: One ST (single mode) port. EKI-5525M-ST/EKI-5525MI-ST: One ST (multi mode) port.

The following view applies to EKI-5524SS, EKI-5524SSI, EKI-5524MM and EKI-5524MMI.

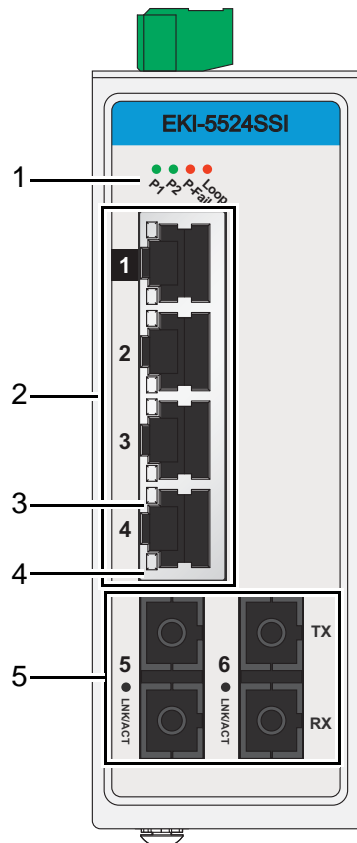

Figure 1-6. Front View

Table 1-9. Front View

No.	Item	Description
1	System LED panel	See “System LED Panel” on page 22 for further details.
2	ETH port	Four RJ45 ports. Port numbers in black are designated for port based Quality of Service (QoS) functionality.
3	LNK/ACT LED	Link activity LED.

Table 1-9. Front View (Continued)

No.	Item	Description
4	Speed LED	Fast Ethernet: <ul style="list-style-type: none"> • Amber: 100M • Off: 10M
5	ST port	EKI-5524SS/EKI-5524SSI: Two SC (single mode) ports. EKI-5524MM/EKI-5524MMI: Two SC (multi mode) ports.

The following view applies to EKI-5524SS-ST, EKI-5524SSI-ST, EKI-5524MM-ST and EKI-5524MMI-ST.

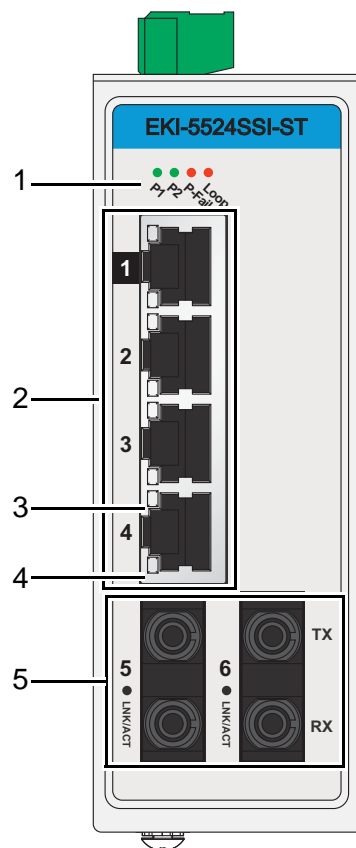

Figure 1-7. Front View

Table 1-10. Front View

No.	Item	Description
1	System LED panel	See “System LED Panel” on page 22 for further details.
2	ETH port	Four RJ45 ports. Port numbers in black are designated for port based Quality of Service (QoS) functionality.
3	LNK/ACT LED	Link activity LED.

Table 1-10. Front View (Continued)

No.	Item	Description
4	Speed LED	Fast Ethernet: <ul style="list-style-type: none"> • Amber: 100M • Off: 10M
5	ST port	EKI-5524SS-ST/EKI-5524SSI-ST: Two ST (single mode) ports. EKI-5524MM-ST/EKI-5524MMI-ST: Two ST (multi mode) ports.

The following view applies to EKI-5526, EKI-5526I, EKI-5726 and EKI-5726I.

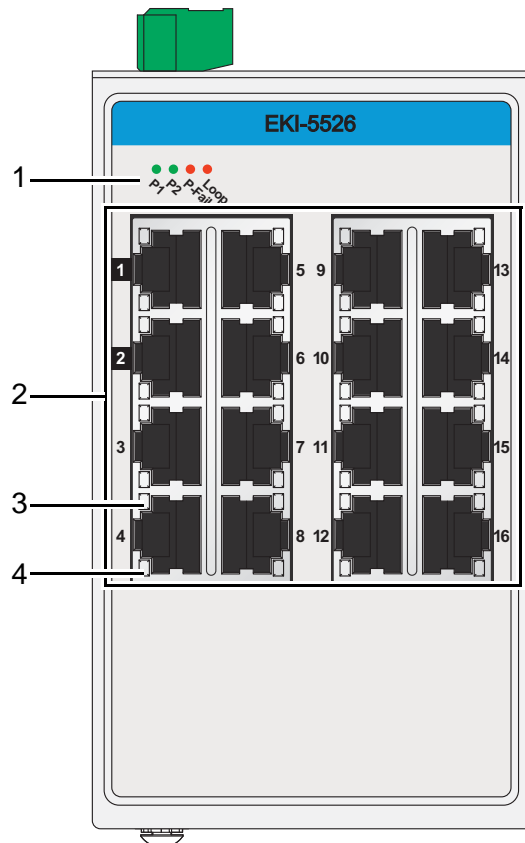

Figure 1-8. Front View

Table 1-11. Front View

No.	Item	Description
1	System LED panel	See “System LED Panel” on page 22 for further details.
2	ETH port	EKI-5526/EKI-5526I: Sixteen 10/100BaseT(X) ports. EKI-5726/EKI-5726I: Sixteen 10/100/1000BaseT(X) ports. Port numbers in black are designated for port based Quality of Service (QoS) functionality.
3	LNK/ACT LED	Link activity LED.

Table 1-11. Front View (Continued)

No.	Item	Description
4	Speed LED	Fast Ethernet: <ul style="list-style-type: none"> • Amber: 100M • Off: 10M

The following view applies to EKI-5629C and EKI-5629CI.

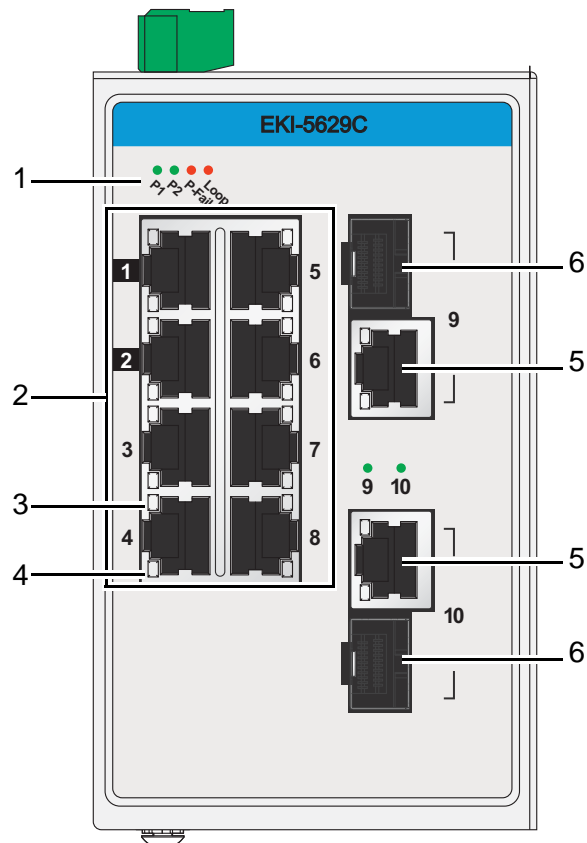

Figure 1-9. Front View

Table 1-12. Front View

No.	Item	Description
1	System LED panel	See “System LED Panel” on page 22 for further details.
2	ETH port	Eight 10/100BaseT(X) ports. Port numbers in black are designated for port based Quality of Service (QoS) functionality.
3	LNK/ACT LED	Link activity LED.
4	Speed LED	Fast Ethernet: <ul style="list-style-type: none"> • Amber: 100M • Off: 10M
5	ETH port	Two 10/100/1000BaseT(X) ports.

Table 1-12. Front View (Continued)

No.	Item	Description
6	ETH port	Two 100/1000Base-FX SFP ports.

The following view applies to EKI-5626C and EKI-5626CI.

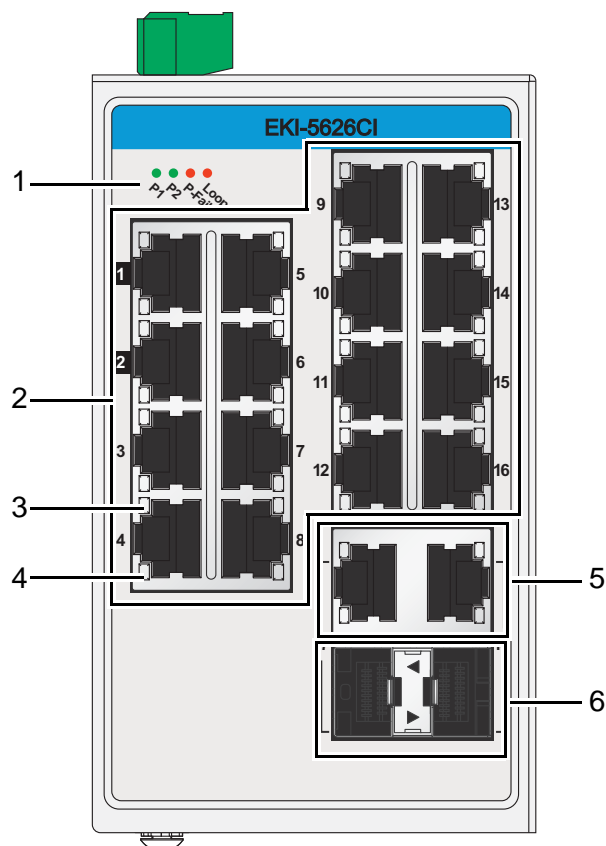

Figure 1-10. Front View

Table 1-13. Front View

No.	Item	Description
1	System LED panel	See “System LED Panel” on page 22 for further details.
2	ETH port	Sixteen 10/100BaseT(X) ports. Port numbers in black are designated for port based Quality of Service (QoS) functionality.
3	LNK/ACT LED	Link activity LED.
4	Speed LED	Fast Ethernet: <ul style="list-style-type: none"> • Amber: 100M • Off: 10M
5	ETH port	Two 10/100/1000BaseT(X) ports.
6	ETH port	Two 100/1000Base-FX SFP ports.

The following view applies to EKI-5726F and EKI-5726FI.

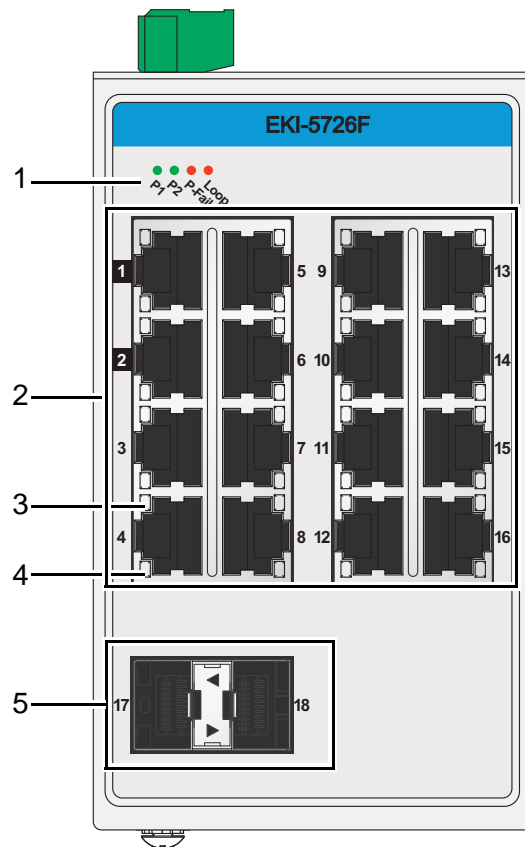

Figure 1-11. Front View

Table 1-14. Front View

No.	Item	Description
1	System LED panel	See “System LED Panel” on page 22 for further details.
2	ETH port	Sixteen 10/100/1000BaseT(X) ports. Port numbers in black are designated for port based Quality of Service (QoS) functionality.
3	LNK/ACT LED	Link activity LED.
4	Speed LED	Gigabit Ethernet: <ul style="list-style-type: none"> • Green: 1000M • Amber: 100M • Off: 10M
5	ETH port	Two 100/1000Base-FX SFP ports.

The following view applies to EKI-5725FP and EKI-5725FPI.

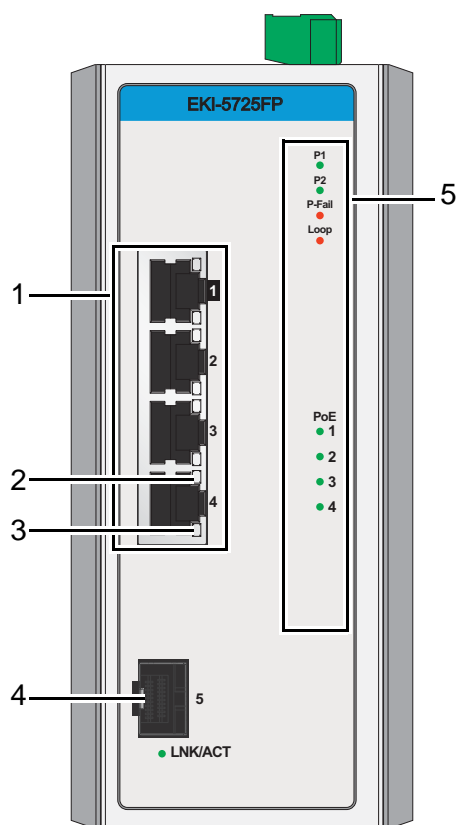

Figure 1-12. Front View

Table 1-15. Front View

No.	Item	Description
1	ETH port	Four 10/100/1000BaseT(X) with PoE ports.
2	LNK/ACT LED	Link activity LED.
3	Speed LED	Gigabit Ethernet: <ul style="list-style-type: none"> ● Green: 1000M ● Amber: 100M ● Off: 10M
4	ETH port	One 100/1000Base-FX, SFP port.
5	System LED panel	See “System LED Panel (only for EKI-5725FP/EKI-5725FPI, EKI-5624P/EKI-5624PI and EKI-5729P/EKI-5729PI)” on page 23 for further details.

The following view applies to EKI-5624P and EKI-5624PI.

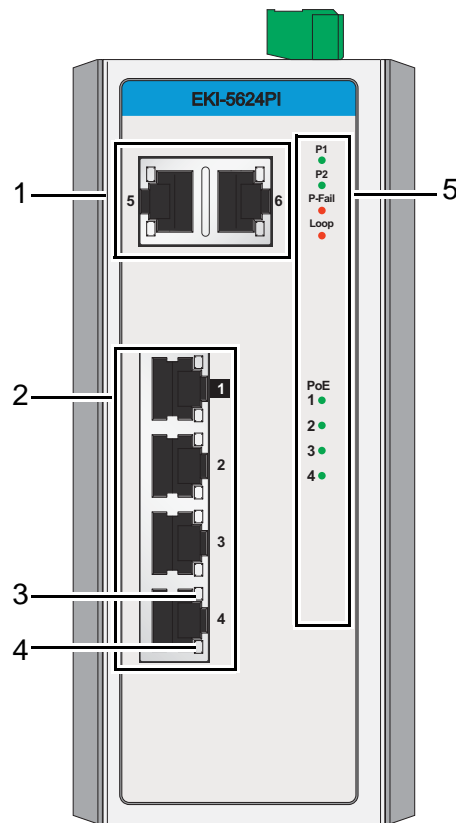

Figure 1-13. Front View

Table 1-16. Front View

No.	Item	Description
1	ETH port	Two 10/100/1000BaseT(X) ports.
2	ETH port	Four 10/100BaseT(X) with PoE ports.
3	LNK/ACT LED	Link activity LED.
4	Speed LED	Fast Ethernet: <ul style="list-style-type: none"> ● Amber: 100M ● Off: 10M
5	System LED panel	See “System LED Panel (only for EKI-5725FP/EKI-5725FPI, EKI-5624P/EKI-5624PI and EKI-5729P/EKI-5729PI)” on page 23 for further details.

The following view applies to EKI-5729P and EKI-5729PI.

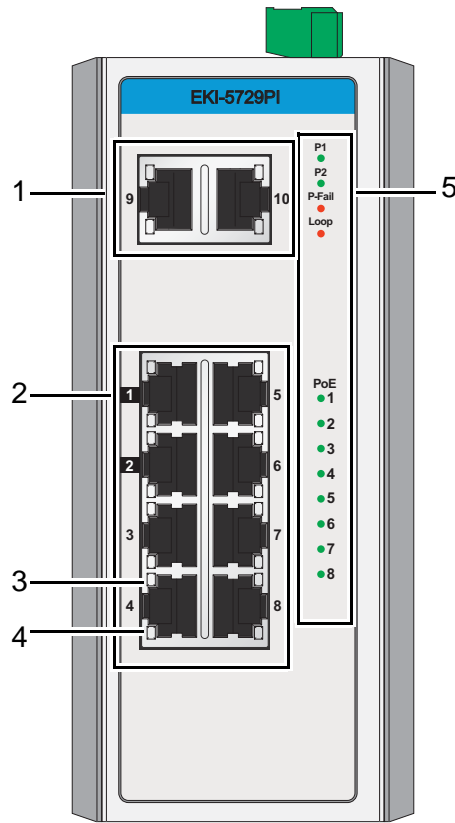

Figure 1-14. Front View

Table 1-17. Front View

No.	Item	Description
1	ETH port	Two 10/100/1000BaseT(X) ports.
2	ETH port	Eight 10/100/1000BaseT(X) with PoE ports.
3	LNK/ACT LED	Link activity LED.
4	Speed LED	Gigabit Ethernet: <ul style="list-style-type: none"> ● Green: 1000M ● Amber: 100M ● Off: 10M
5	System LED panel	See “System LED Panel (only for EKI-5725FP/EKI-5725FPI, EKI-5624P/EKI-5624PI and EKI-5729P/EKI-5729PI)” on page 23 for further details.

System LED Panel

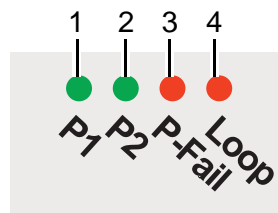

Figure 1-15. System LED Panel

Table 1-18. System LED Panel

No.	LED Name	LED Color	Description
1	PW1 LED	Solid green	Powered up.
		Off	Powered down or not installed.
2	PW2 LED	Solid green	Powered up.
		Off	Powered down or not installed.
3	P-Fail	Solid red	When PW1 or PW2 is disconnected, the LED lights.
		Off	When PW1 and PW2 is connected, the LED is off.
4	Loop	Solid red	When loop detected, the LED lights.
		Off	No loop detected.

System LED Panel (only for EKI-5725FP/EKI-5725FPI, EKI-5624P/EKI-5624PI and EKI-5729P/EKI-5729PI)

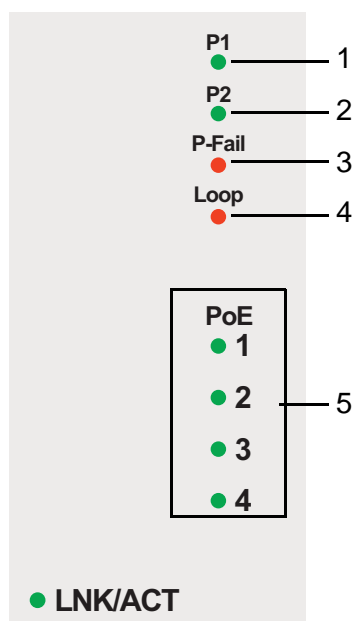

Figure 1-16. System LED Panel

Table 1-19. System LED Panel

No.	LED Name	LED Color	Description
1	PW1 LED	Solid green	Powered up.
		Off	Powered down or not installed.
2	PW2 LED	Solid green	Powered up.
		Off	Powered down or not installed.
3	P-Fail	Solid red	When PW1 or PW2 is disconnected, the LED lights.
		Off	When PW1 and PW2 is connected, the LED is off.
4	Loop	Solid red	When loop detected, the LED lights.
		Off	No loop detected.
5	PoE (depending the PoE ports)	Solid green	PoE activated.
		Off	PoE non-working.
	SFP (only for EKI-5725FP/EKI-5725FPI)	Solid green	SFP activated.
		Blinking	Data is being transmitted.
		Off	SFP non-working.

1.3.2 Rear View

The following view applies to EKI-5525S, EKI-5525SI, EKI-5525M, EKI-5525MI, EKI-5525S-ST, EKI-5525SI-ST, EKI-5525M-ST, EKI-5525MI-ST, EKI-5525, EKI-5525I, EKI-5725 and EKI-5725I.

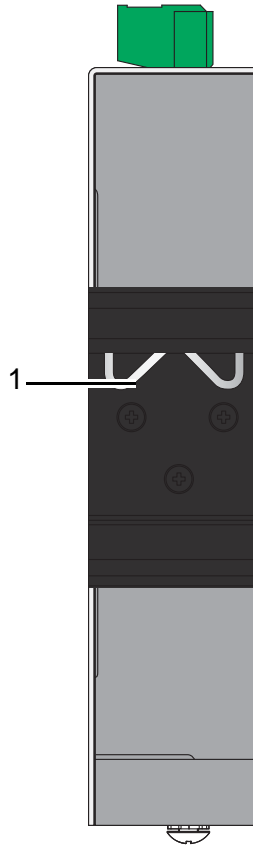

Figure 1-17. Rear View

Table 1-20. Rear View

No.	Item	Description
1	DIN-Rail mounting plate	Mounting plate used for the installation to a standard DIN rail.

The following view applies to EKI-5728, EKI-5728I, EKI-5729F, EKI-5729FI, EKI-5528, EKI-5528I, EKI-5524SS, EKI-5524SSI, EKI-5524MM, EKI-5524MMI, EKI-5524SS-ST, EKI-5524SSI-ST, EKI-5524MM-ST and EKI-5524MMI-ST.

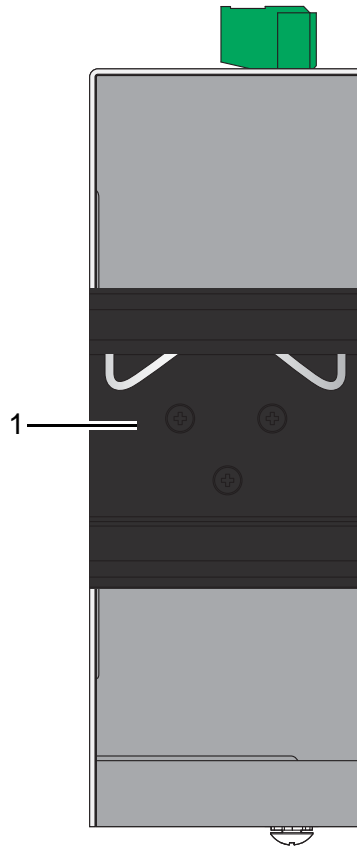

Figure 1-18. Rear View

Table 1-21. Rear View

No.	Item	Description
1	DIN-Rail mounting plate	Mounting plate used for the installation to a standard DIN rail.

The following view applies to EKI-5526, EKI-5526I, EKI-5629C, EKI-5629CI, EKI-5626C, EKI-5626CI, EKI-5726, EKI-5726I, EKI-5726F and EKI-5726FI.

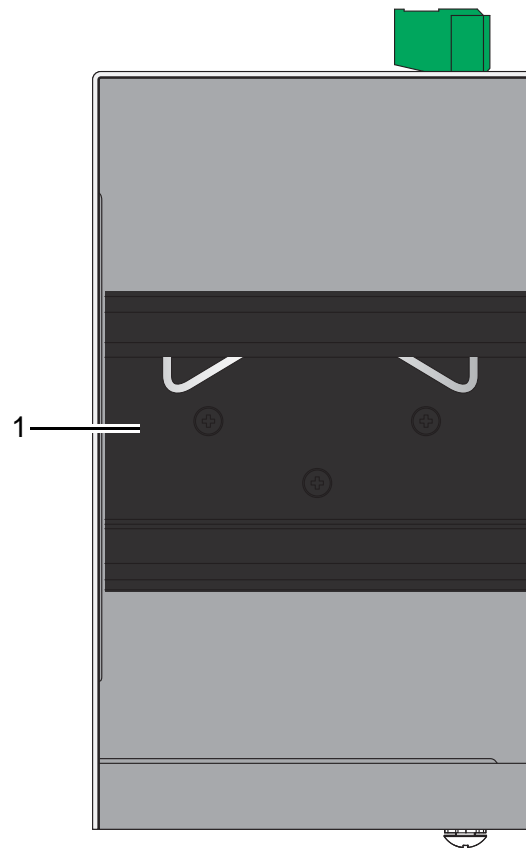

Figure 1-19. Rear View

Table 1-22. Rear View

No.	Item	Description
1	DIN-Rail mounting plate	Mounting plate used for the installation to a standard DIN rail.

The following view applies to EKI-5725FP, EKI-5725FPI, EKI-5624P, EKI-5624PI, EKI-5729P and EKI-5729PI

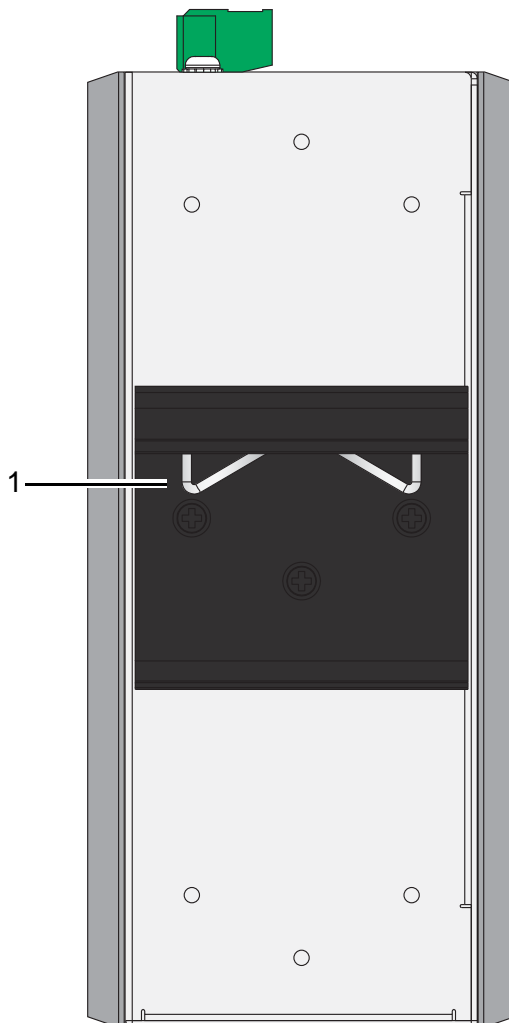

Figure 1-20. Rear View

Table 1-23. Rear View

No.	Item	Description
1	DIN-Rail mounting plate	Mounting plate used for the installation to a standard DIN rail.

1.3.3 Top View

The following view applies to EKI-5525S, EKI-5525SI, EKI-5525M, EKI-5525MI, EKI-5525S-ST, EKI-5525SI-ST, EKI-5525M-ST, EKI-5525MI-ST, EKI-5525, EKI-5525I, EKI-5725 and EKI-5725I.

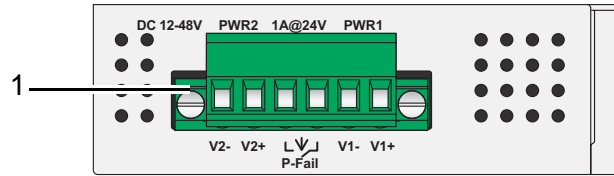

Figure 1-21. Top View

Table 1-24. Top View

No.	Item	Description
1	Terminal block	Connect cabling for power and alarm wiring.

The following view applies to EKI-5728, EKI-5728I, EKI-5729F, EKI-5729FI, EKI-5528, EKI-5528I, EKI-5524SS, EKI-5524SSI, EKI-5524MM, EKI-5524MMI, EKI-5524SS-ST, EKI-5524SSI-ST, EKI-5524MM-ST and EKI-5524MMI-ST.

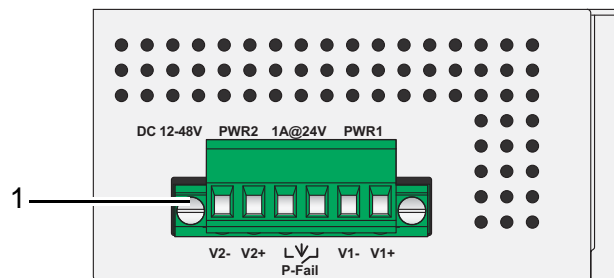

Figure 1-22. Top View

Table 1-25. Top View

No.	Item	Description
1	Terminal block	Connect cabling for power and alarm wiring.

The following view applies to EKI-5526, EKI-5526I, EKI-5629C, EKI-5629CI, EKI-5626C and EKI-5626CI.

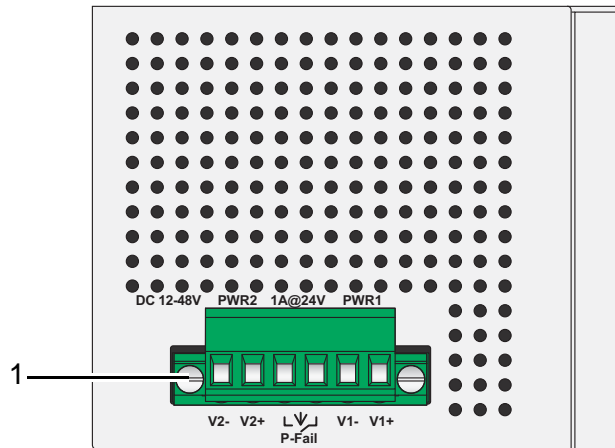

Figure 1-23. Top View

Table 1-26. Top View

No.	Item	Description
1	Terminal block	Connect cabling for power and alarm wiring.

The following view applies to EKI-5726, EKI-5726I, EKI-5726I and EKI-5726FI.

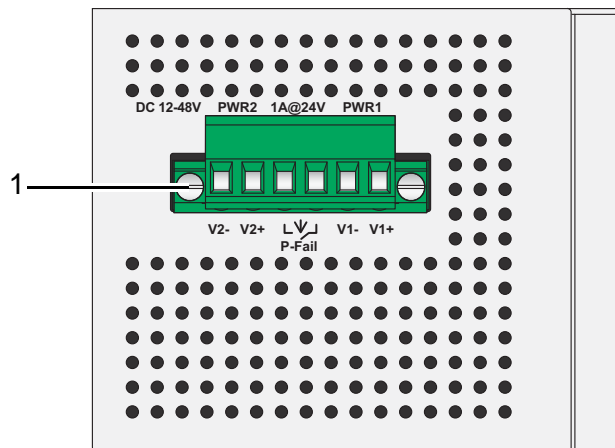

Figure 1-24. Top View

Table 1-27. Top View

No.	Item	Description
1	Terminal block	Connect cabling for power and alarm wiring.

The following view applies to EKI-5725FP and EKI-5725FPI.

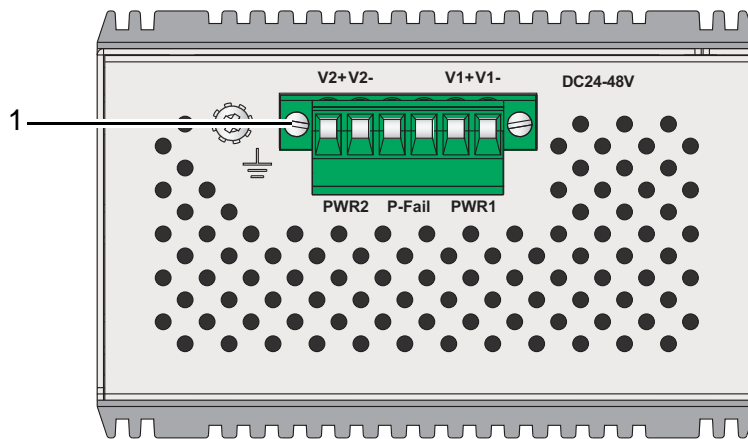

Figure 1-25. Top View

Table 1-28. Top View

No.	Item	Description
1	Terminal block	Connect cabling for power and alarm wiring.

The following view applies to EKI-5624P, EKI-5624PI, EKI-5729P and EKI-5729PI.

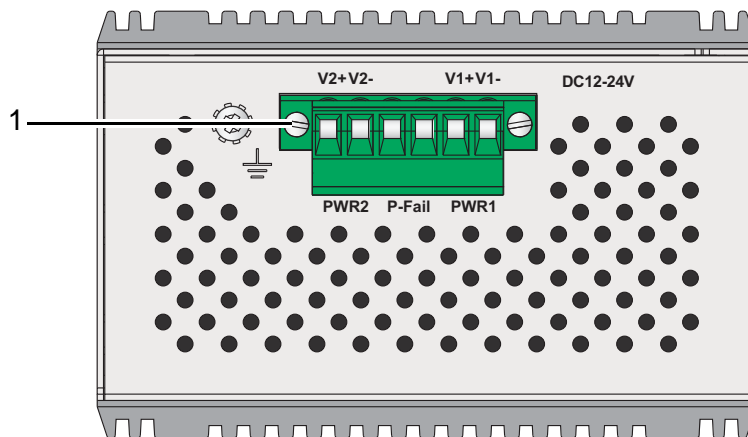

Figure 1-26. Top View

Table 1-29. Top View

No.	Item	Description
1	Terminal block	Connect cabling for power and alarm wiring.

1.3.4 Bottom View

The following view applies to EKI-5525S, EKI-5525SI, EKI-5525M, EKI-5525MI, EKI-5525S-ST, EKI-5525SI-ST, EKI-5525M-ST, EKI-5525MI-ST, EKI-5525, EKI-5525I, EKI-5725 and EKI-5725I.

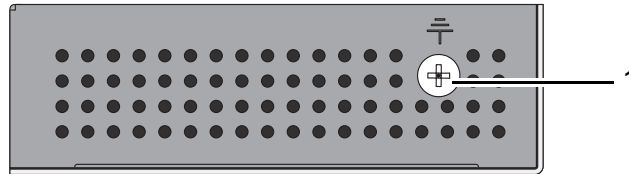

Figure 1-27. Bottom View

Table 1-30. Bottom View

No.	Item	Description
1	Ground terminal	Screw terminal used to ground chassis.

The following view applies to EKI-5728, EKI-5728I, EKI-5729F, EKI-5729FI, EKI-5528, EKI-5528I, EKI-5524SS, EKI-5524SSI, EKI-5524MM, EKI-5524MMI, EKI-5524SS-ST, EKI-5524SSI-ST, EKI-5524MM-ST and EKI-5524MMI-ST.

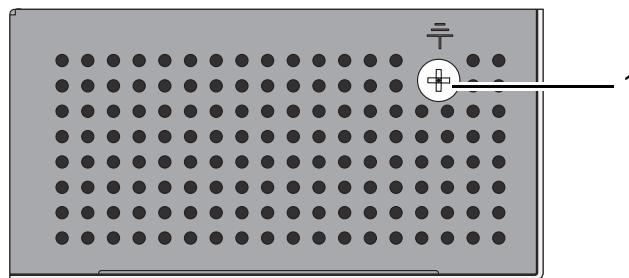

Figure 1-28. Bottom View

Table 1-31. Bottom View

No.	Item	Description
1	Ground terminal	Screw terminal used to ground chassis.

The following view applies to EKI-5526, EKI-5526I, EKI-5629C, EKI-5629CI, EKI-5626C, EKI-5626CI, EKI-5726, EKI-5726I, EKI-5726F and EKI-5726FI.

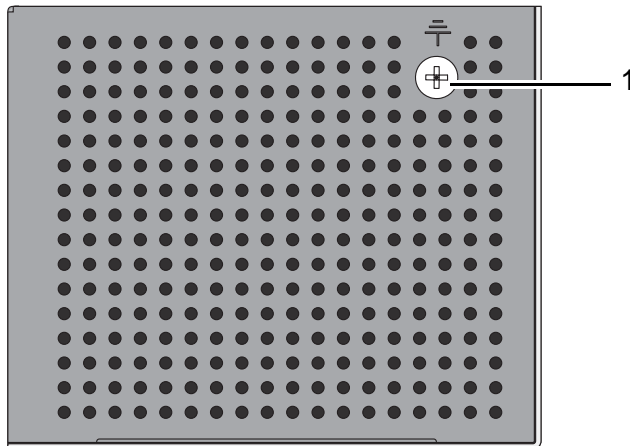

Figure 1-29. Bottom View

Table 1-32. Bottom View

No.	Item	Description
1	Ground terminal	Screw terminal used to ground chassis.

The following view applies to EKI-5725FP, EKI-5725FPI, EKI-5624P, EKI-5624PI, EKI-5729P and EKI-5729PI.

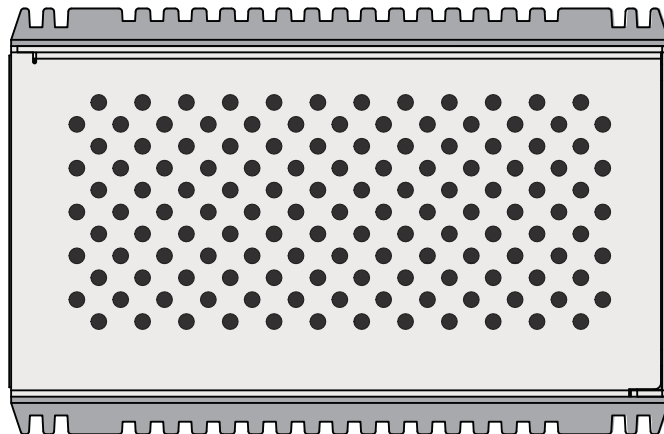

Figure 1-30. Bottom View

1.4. Packing List

The product package you have received should contain the following items. If any of them are not included or damaged, please contact your local vendor for support.

- 1 x Industrial Ethernet Switch
- 1 x Wall-mounting Bracket
- 1 x DIN-Rail mounting Bracket and Screws
- 1 x EKI Device Configuration Utility CD-ROM
- 1 x Startup Manual

Switch Installation

Chapter 2

2.1. Installation Guidelines

The following guidelines are provided to optimize the device performance. Review the guidelines before installing the device.

- Make sure cabling is away from sources of electrical noise. Radios, power lines, and fluorescent lighting fixtures can interference with the device performance.
- Make sure the cabling is positioned away from equipment that can damage the cables.
- Operating environment is within the ranges listed range, see “Specifications” on page 2.
- Relative humidity around the switch does not exceed 95 percent (noncondensing).
- Altitude at the installation site is not higher than 10,000 feet.
- In 10/100 and 10/100/1000 fixed port devices, the cable length from the switch to connected devices can not exceed 100 meters (328 feet).
- Make sure airflow around the switch and respective vents is unrestricted. Without proper airflow the switch can overheat. To prevent performance degradation and damage to the switch, make sure there is clearance at the top and bottom and around the exhaust vents.

2.1.1 Connecting Hardware

In this instruction, it will explain how to find a proper location for your Modbus Gateways, and how to connect to the network, hook up the power cable, and connect to the EKI-5000 Series.

2.2. Verifying Switch Operation

Before installing the device in a rack or on a wall, power on the switch to verify that the switch passes the power-on self-test (POST). To connect the cabling to the power source see “Power Supply Installation” on page 43.

At startup (POST), the System LED blinks green, while the remaining LEDs are a solid green. Once the switch passes POST self-test, the System LED turns green. The other LEDs turn off and return to their operating status. If the switch fails POST, the System LED switches to an amber state.

After a successful self-test, power down the switch and disconnect the power cabling.

The switch is now ready for installation on its final location.

2.3. Installing the Switch

2.3.1 DIN Rail Mounting

The DIN rail mount option is the quickest installation option. Additionally, it optimizes the use of rail space.

The metal DIN rail kit is secured to the rear of the switch. The device can be mounted onto a standard 35mm (1.37") x 75 mm (3") height DIN rail. The devices can be mounted vertically or horizontally. Refer to the following guidelines for further information.



A corrosion-free mounting rail is advisable.

When installing, make sure to allow for enough space to properly install the cabling.

Installing the DIN-Rail Mounting Kit

1. Insert the top back of the mounting bracket over the DIN rail.
2. Push the bottom of the switch towards the DIN rail until it snaps into place.

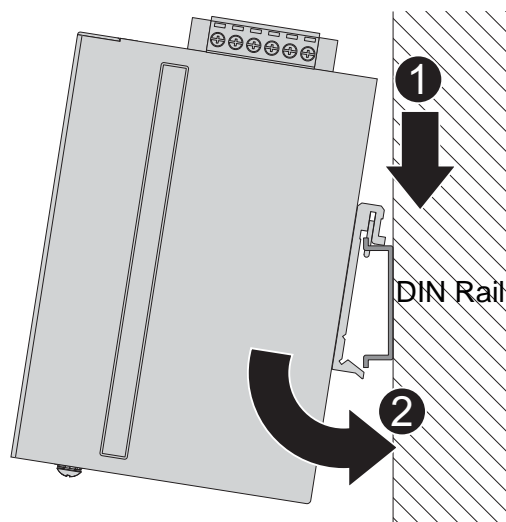

Figure 2-1. Installing the DIN-Rail Mounting Kit

Removing the DIN-Rail Mounting Kit

1. Push the switch down to free the bottom of the plate from the DIN rail.
2. Rotate the bottom of the device towards you and away from the DIN rail.
3. Once the bottom is clear of the DIN rail, lift the device straight up to unhook it from the DIN rail.

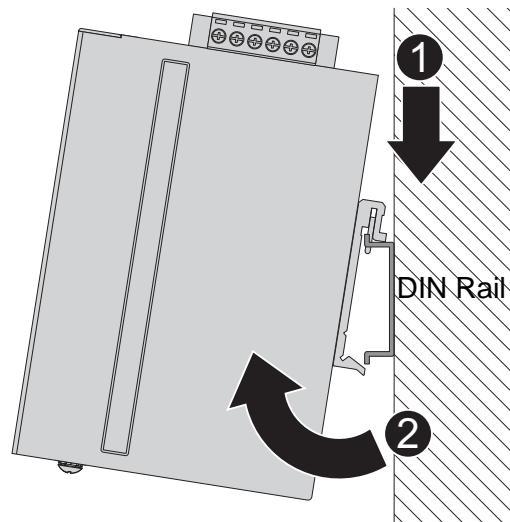

Figure 2-2. Removing the DIN-Rail

2.3.2 Wall-Mounting

The wall mounting option provides better shock and vibration resistance than the DIN rail vertical mount.



When installing, make sure to allow for enough space to properly install the cabling.

Before the device can be mounted on a wall, you will need to remove the DIN rail plate.

1. Rotate the device to the rear side and locate the DIN mounting plate.
2. Remove the screws securing the DIN mounting plate to the rear panel of the switch.
3. Remove the DIN mounting plate. Store the DIN mounting plate and provided screws for later use.
4. Align the wall mounting plates on the rear side. The screw holes on the device and the mounting plates must be aligned, see the following illustration.

- Secure the wall mount plates with M3 screws, see the following figure.

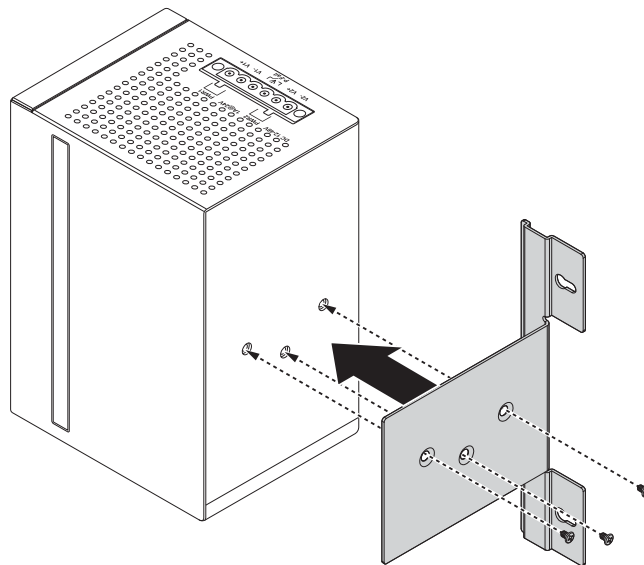

Figure 2-3. Installing Wall Mount Plates

Once the wall mounting plates are secure on the device, you will need to attach the wall screws (x3).

- Locate the installation site and place the switch against the wall, making sure it is the final installation location.
- Use the wall mount plates as a guide to mark the locations of the screw holes.
- Drill four holes over the four marked locations on the wall, keeping in mind that the holes must accommodate wall sinks in addition to the screws.
- Insert the wall sinks into the walls.
- Insert the screws into the wall sinks. Leave a 2 mm gap between the wall and the screw head to allow for wall mount plate insertion.



Figure 2-4. Securing Wall Mounting Screws



- Make sure the screws dimensions are suitable for use with the wall mounting plate.
- Do not completely tighten the screws into the wall. A final adjustment may be needed before fully securing the wall mounting plates on the wall.

- Align the wall mount plate over the screws on the wall.

12. Install the wall mount plate on the screws and slide it forward to lock in place, see the following figure.

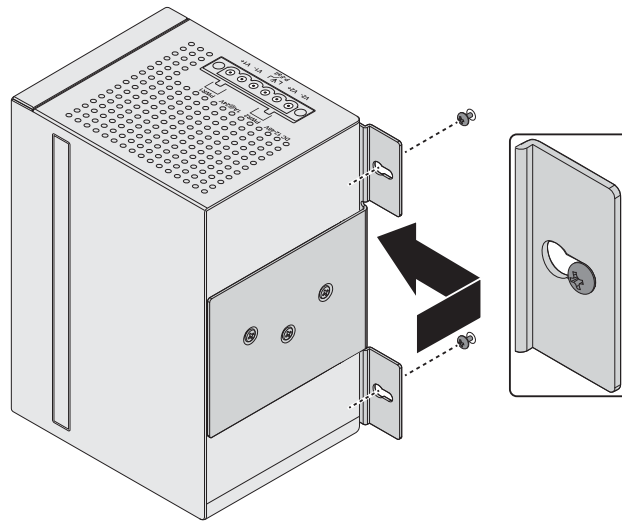

Figure 2-5. Wall Mount Installation

13. Once the device is installed on the wall, tighten the screws to secure the device.

2.4. Installing and Removing SFP Modules

Up to two fiber optic ports are available (dependent on model) for use in the switch. Refer to the technical specifications for details.

The Gigabit Ethernet ports on the switch are 100/1000Base SFP Fiber ports, which require using the 100M or 1G mini-GBIC fiber transceivers to work properly. Advantech provides completed transceiver models for different distance requirement.

The concept behind the LC port and cable is quite straight forward. Suppose that you are connecting devices I and II; contrary to electrical signals, optical signals do not require a circuit in order to transmit data. Consequently, one of the optical lines is used to transmit data from device I to device II, and the other optical line is used transmit data from device II to device I, for full-duplex transmission.

Remember to connect the Tx (transmit) port of device I to the Rx (receive) port of device II, and the Rx (receive) port of device I to the Tx (transmit) port of device II. If you make your own cable, we suggest labeling the two sides of the same line with the same letter (A-to-A and B-to-B, as shown below, or A1-to-A2 and B1-to-B2).



This is a Class 1 Laser/LED product. To avoid causing serious damage to your eyes, do not stare directly into the Laser Beam.

2.4.1 Installing SFP Modules

To connect the fiber transceiver and LC cable, use the following guidelines:

1. Remove the dust plug from the fiber optic slot chosen for the SFP transceiver.

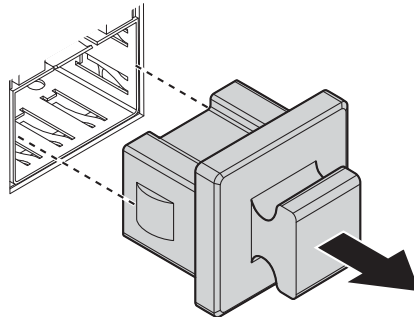

Figure 2-6. Removing the Dust Plug from an SFP Slot



Do not remove the dust plug from the SFP slot if you are not installing the transceiver at this time. The dust plug protects hardware from dust contamination.

2. Position the SFP transceiver with the handle on top, see the following figure.
3. Locate the triangular marking in the slot and align it with the bottom of the transceiver.
4. Insert the SFP transceiver into the slot until it clicks into place.
5. Make sure the module is seated correctly before sliding the module into the slot. A click sounds when it is locked in place.

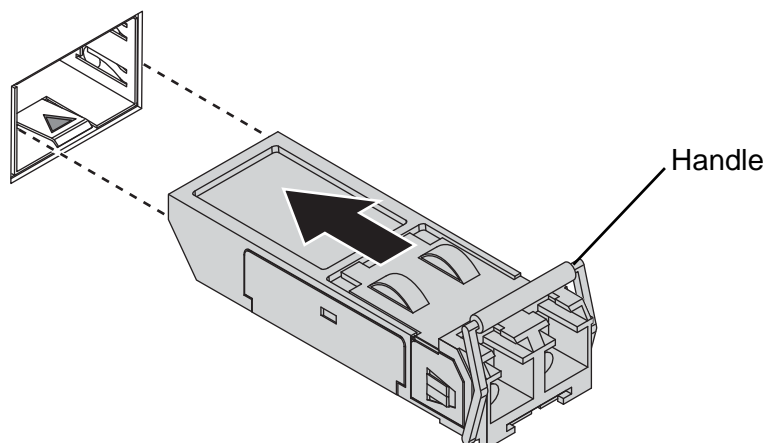

Figure 2-7. Installing an SFP Transceiver



If you are attaching fiber optic cables to the transceiver, continue with the following step. Otherwise, repeat the previous steps to install the remaining SFP transceivers in the device.

6. Remove the protective plug from the SFP transceiver.



Do not remove the dust plug from the transceiver if you are not installing the fiber optic cable at this time. The dust plug protects hardware from dust contamination.

7. Insert the fiber cable into the transceiver. The connector snaps into place and locks.

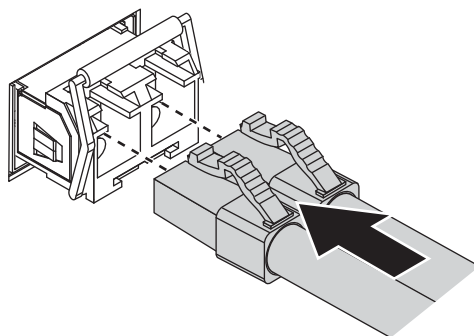

Figure 2-8. Attaching a Fiber Optic Cable to a Transceiver

8. Repeat the previous procedures to install any additional SFP transceivers in the switch. The fiber port is now setup.

2.4.2 Removing SFP Modules

To disconnect an LC connector, use the following guidelines:

1. Press down and hold the locking clips on the upper side of the optic cable.
2. Pull the optic cable out to release it from the transceiver.

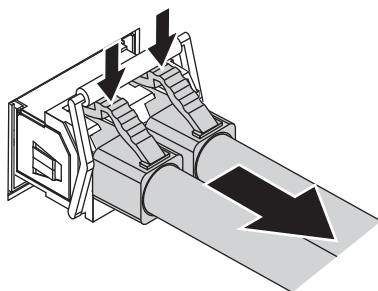

Figure 2-9. Removing a Fiber Optic Cable to a Transceiver

3. Hold the handle on the transceiver and pull the transceiver out of the slot.

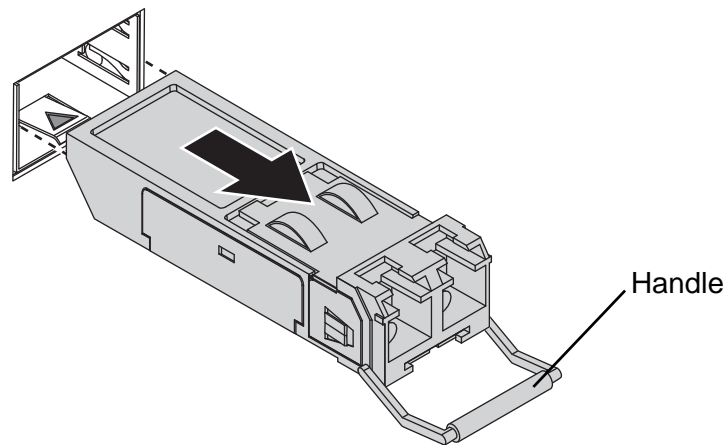

Figure 2-10. Removing an SFP Transceiver



Replace the dust plug on the slot if you are not installing a transceiver. The dust plug protects hardware from dust contamination.

2.5. Connecting the Switch to Ethernet Ports

2.5.1 RJ45 Ethernet Cable Wiring

For RJ45 connectors, data-quality, twisted pair cabling (rated CAT5 or better) is recommended. The connector bodies on the RJ45 Ethernet ports are metallic and connected to the GND terminal. For best performance, use shielded cabling. Shielded cabling may be used to provide further protection.

Table 2-1. RJ45 Ethernet Wiring for Reference

Straight-thru Cable Wiring		Cross-over Cable Wiring	
Pin 1	Pin 1	Pin 1	Pin 3
Pin 2	Pin 2	Pin 2	Pin 6
Pin 3	Pin 3	Pin 3	Pin 1
Pin 6	Pin 6	Pin 6	Pin 2

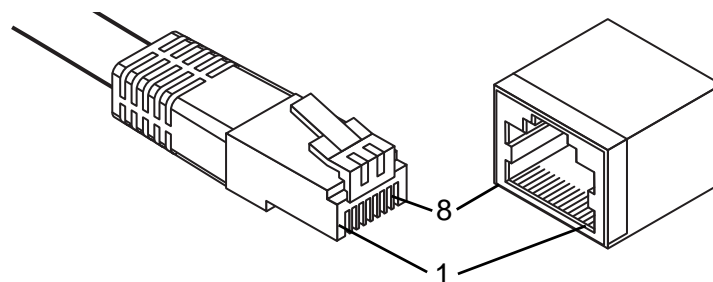

Figure 2-11. Ethernet Plug & Connector Pin Position

Maximum cable length: 100 meters (328 ft.) for 10/100/1000BaseT.

2.6. Power Supply Installation

2.6.1 Overview



POWER DOWN AND DISCONNECT THE POWER CORD BEFORE SERVICING OR WIRING THE SWITCH.



Do not disconnect modules or cabling unless the power is first switched off. The device only supports the voltage outlined in the type plate. Do not use any other power components except those specifically designated for the switch device.



Disconnect the power cord before installation or cable wiring.

The switches can be powered by using the same DC source used to power other devices. A DC voltage range of 12 to 48 VDC must be applied between the V1+ terminal and the V1- terminal (PW1), see the following illustrations. A Class 2 power supply is required to maintain a UL60950 panel listing. The chassis ground screw terminal should be tied to the panel or chassis ground. A redundant power configuration is supported through a secondary power supply unit to reduce network down time as a result of power loss.

EKI-5000 Series support 12 and 48 VDC. Dual power inputs are supported and allow you to connect a backup power source.

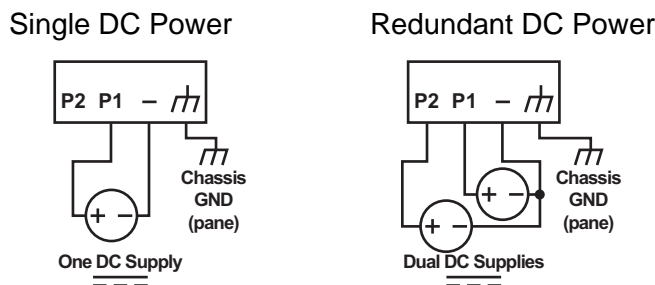

Figure 2-12. Power Wiring for EKI-5000 Series

2.6.2 Considerations

Take into consideration the following guidelines before wiring the device:

- The Terminal Block (CN1) is suitable for 12-24 AWG (3.31 - 0.205 mm²). Torque value 7 lb-in.
- The cross sectional area of the earthing conductors shall be at least 3.31 mm².
- Calculate the maximum possible current for each power and common wire. Make sure the power draw is within limits of local electrical code regulations.
- For best practices, route wiring for power and devices on separate paths.
- Do not bundle together wiring with similar electrical characteristics.

- Make sure to separate input and output wiring.
- Label all wiring and cabling to the various devices for more effective management and servicing.



Routing communications and power wiring through the same conduit may cause signal interference. To avoid interference and signal degradation, route power and communications wires through separate conduits.

2.6.3 Grounding the Device



Do not disconnect modules or cabling unless the power is first switched off. The device only supports the voltage outlined in the type plate. Do not use any other power components except those specifically designated for the switch device.



Before connecting the device properly ground the device. Lack of a proper grounding setup may result in a safety risk and could be hazardous.



Do not service equipment or cables during periods of lightning activity.



Do not service any components unless qualified and authorized to do so.



Do not block air ventilation holes.

Electromagnetic Interference (EMI) affects the transmission performance of a device. By properly grounding the device to earth ground through a drain wire, you can setup the best possible noise immunity and emissions.

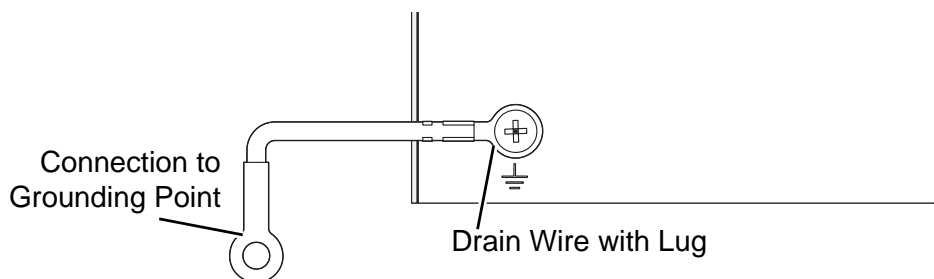

Figure 2-13. Grounding Connection

By connecting the ground terminal by drain wire to earth ground the switch and chassis can be ground.



Before applying power to the grounded switch, it is advisable to use a volt meter to ensure there is no voltage difference between the power supply's negative output terminal and the grounding point on the switch.

2.6.4 Wiring a Relay Contact

The following section details the wiring of the relay output. The terminal block on the EKI-5000 Series is wired and then installed onto the terminal receptor located on the EKI-5000 Series.

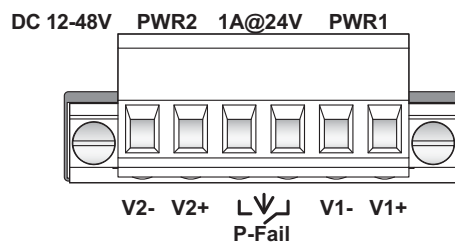

Figure 2-14. Terminal Receptor: Relay Contact

The terminal receptor includes a total of six pins: two for PWR1, two for PWR2 and two for a fault circuit.

2.6.5 Wiring the Power Inputs



Do not disconnect modules or cabling unless the power is first switched off. The device only supports the voltage outlined in the type plate. Do not use any other power components except those specifically designated for the switch device.



POWER DOWN AND DISCONNECT THE POWER CORD BEFORE SERVICING OR WIRING THE SWITCH.

There are two power inputs for normal and redundant power configurations. The power input 2 is used for wiring a redundant power configuration. See the following for terminal block connector views.

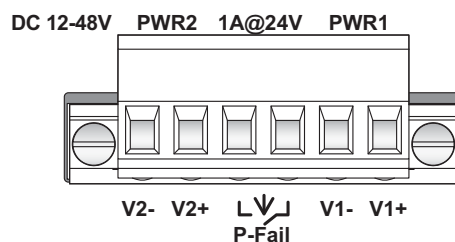

Figure 2-15. Terminal Receptor: Power Input Contacts

To wire the power inputs:

Make sure the power is not connected to the switch or the power converter before proceeding.

1. Loosen the screws securing terminal block to the terminal block receptor.
2. Remove the terminal block from the switch.

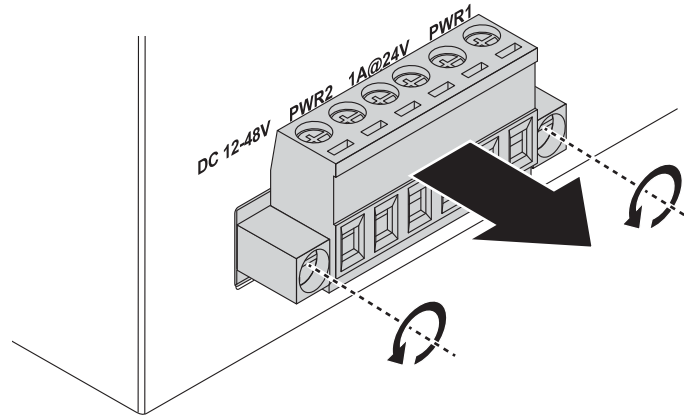

Figure 2-16. Removing a Terminal Block

3. Insert a small flat-bladed screwdriver in the V1+/V1- wire-clamp screws, and loosen the screws.
4. Insert the negative/positive DC wires into the V+/V- terminals of PW1. If setting up power redundancy, connect PW2 in the same manner.
5. Tighten the wire-clamp screws to secure the DC wires in place.

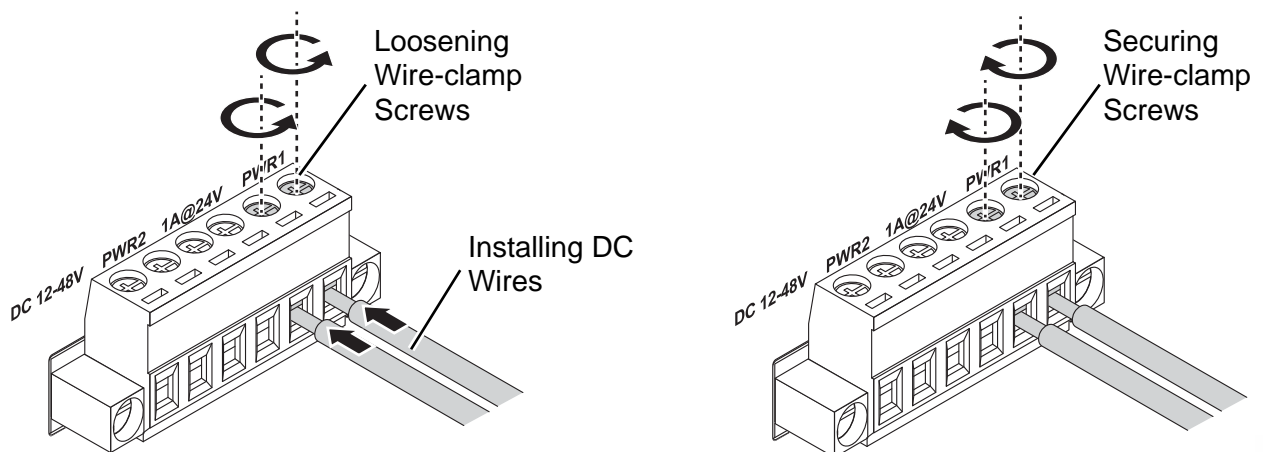

Figure 2-17. Installing DC Wires in a Terminal Block

6. Align the terminal block over the terminal block receptor on the switch.
7. Insert the terminal block and press it in until it is flush with the terminal block receptor.

8. Tighten the screws on the terminal block to secure it to the terminal block receptor. If there is no gap between the terminal block and the terminal receptor, the terminal block is seated correctly.

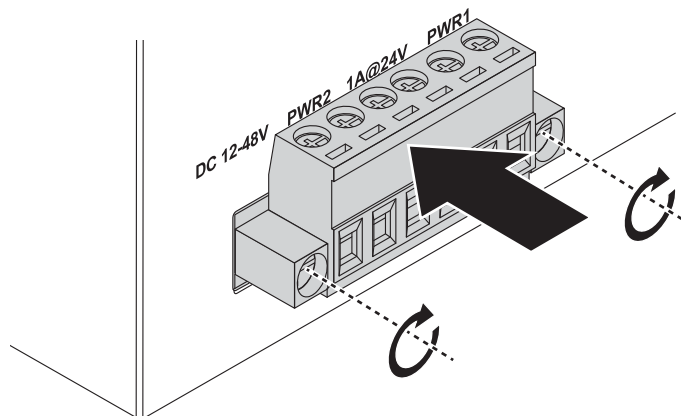

Figure 2-18. Securing a Terminal Block to a Receptor

Configuration Utility

Chapter 3

3.1. Overview

This section describes the installation procedures for the Advantech EKI Device Configuration Utility.

The Configuration Utility is the software tool for setting up and monitoring the EKI-5000 Series.

3.2. Enabling ProView Function

The configuration of a ProView switch can be accessed by using EKI Device Configuration Utility. To install the software utility see “Installing the Configuration Utility” on page 50.

The ProView features for the device must be enabled. The following guidelines allow you to enable and disable the ProView features.



Microsoft Windows 7 is used as a reference for the development of the following guidelines. The following navigation references may differ depending on your operating system.

To fully access all the available options in the Configuration Utility, administrative privileges are required. Without the use of administrative privileges, some functions of the Configuration Utility are not accessible.

Before continuing further, any devices selected for configuration must be connected and powered on, see “Installation Guidelines” on page 35.

1. From your Windows desktop, locate the **Start** button to open the Start Menu.
2. Navigate to **All Programs > EKI Device Configuration Utility**.
3. Locate **Advantech EKI Device Configuration Utility** and right-click on it. From the pop-up menu, select **Run as Administrator**. See your network administrator to obtain the privileges required.
4. A security screen displays, select **Yes** to continue.
5. Select **Search Again** to detect any connected devices.

Once a device is detected, it is listed under the **EKI Device** listing in the **Tree View**.

6. Select the device to configure by clicking on it.
7. Select **System** tab to bring up the **Enable ProView Features** field.

Before a device can be configured, the ProView feature must be enabled.

- Click the Enable ProView Features radio button and click **Apply** to configure the device.

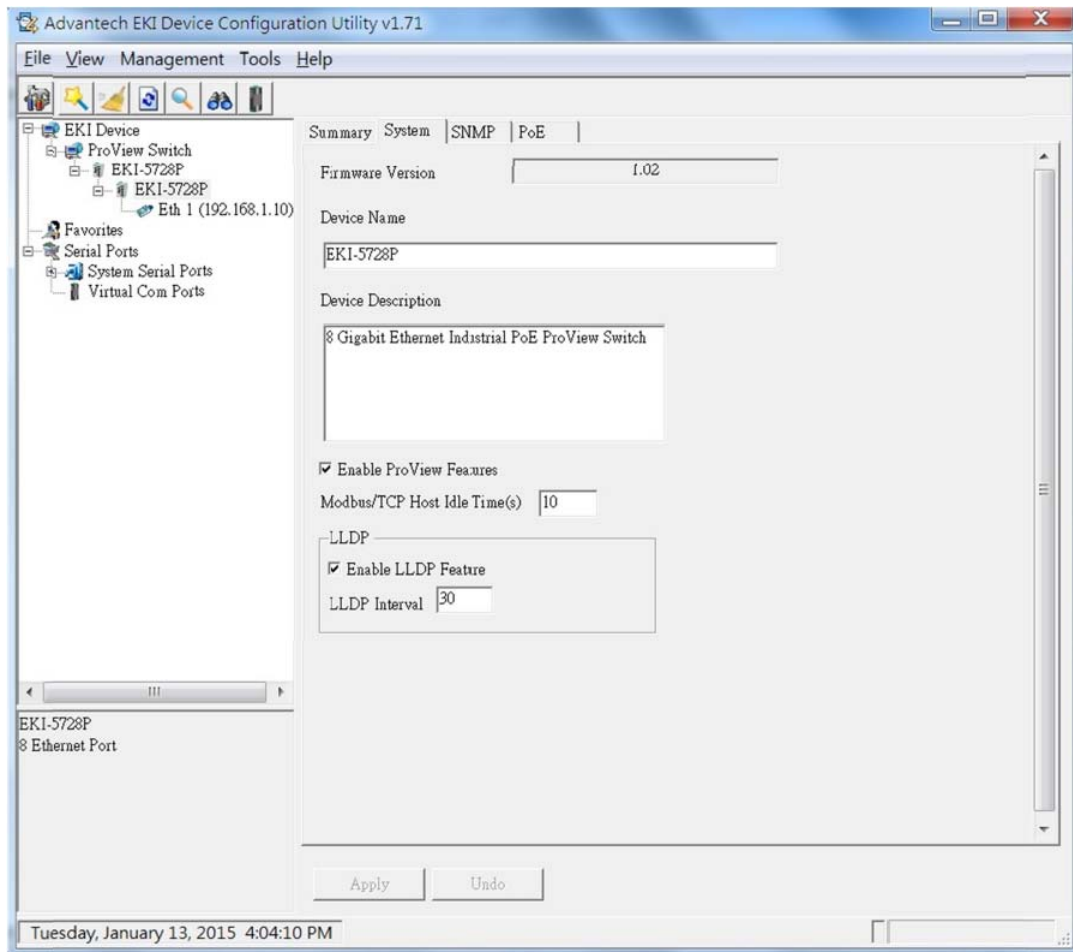

Figure 3-1. Enabling ProView Features

The ProView function is enabled and the switch can be configured.

3.3. Installing the Configuration Utility



Microsoft .NET Framework version 2.0 or greater is required for this application.

- Insert the Advantech EKI Device Configuration Utility CD-ROM into the CD-ROM drive (whereas E:\ is the drive name of your CD-ROM) on the host PC.
- Use Windows explorer or the Windows Run command to execute the setup program, the path for the setup program on the CD-ROM is as follows:
E:\EKI_Device_Configuration_UTILITY_v1.70.exe
- If there is an existing COM port mapping utility on the host PC, remove it at this time. A system reboot may be necessary before continuing the installation.

- Once the InstallShield Wizard screen displays, click **Next** to proceed with the installation.

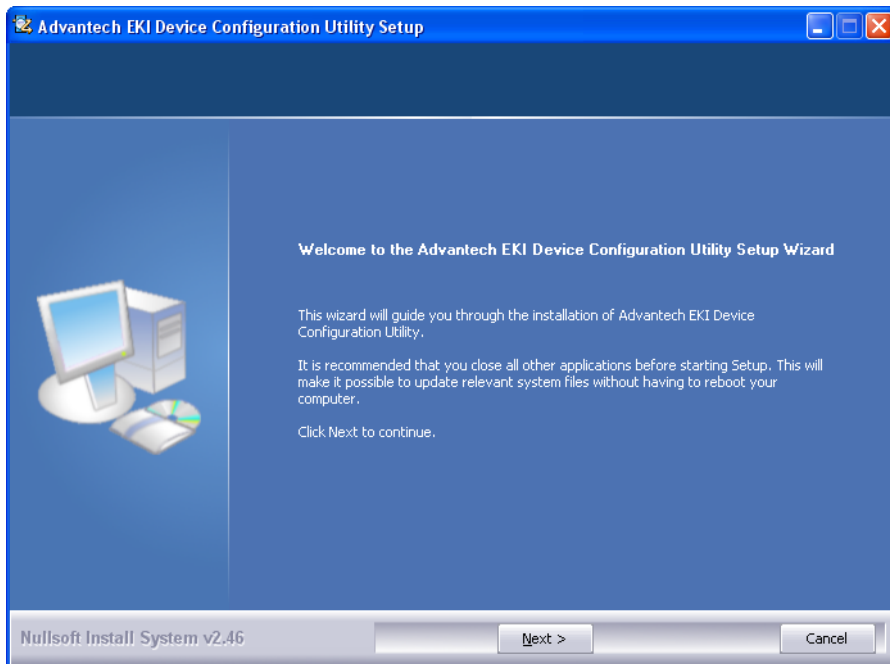

Figure 3-2. InstallShield Wizard 1 of 4

- The Software License Agreement displays, press **I Agree** to continue or **Cancel** to stop the installation.

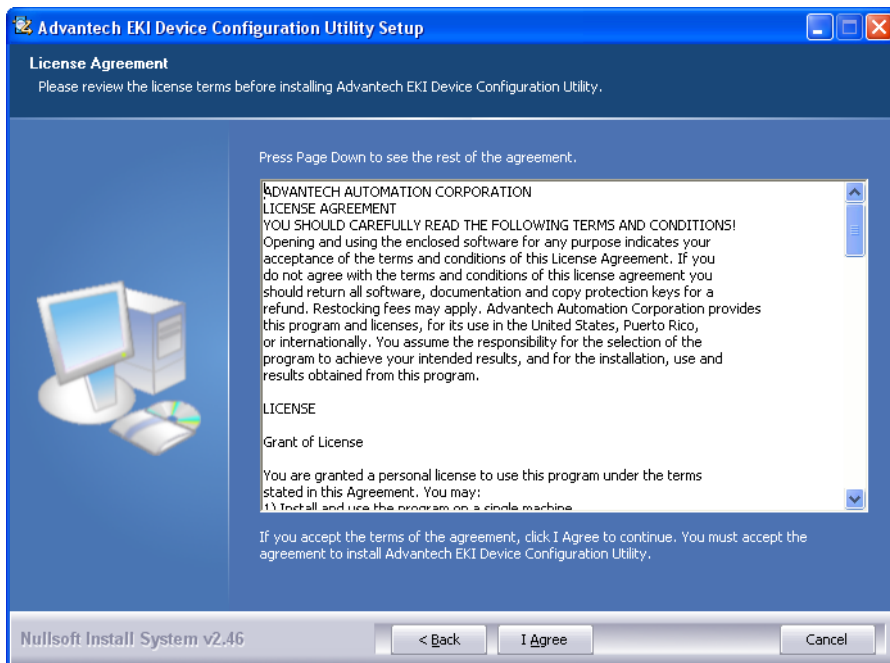

Figure 3-3. InstallShield Wizard 2 of 4

The InstallShield continues and a status screen displays. The default installation path is C:\Program Files\EKI Device Configuration Utility.

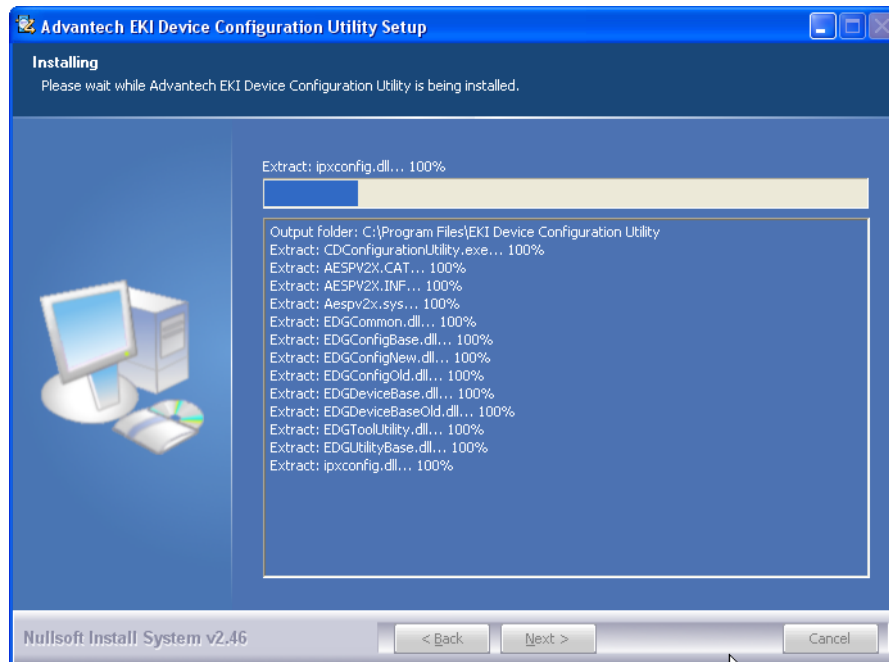

Figure 3-4. InstallShield Wizard 3 of 4

6. Once the installation of the package is finished a Configuration Utility Setup screen displays. Click **Finish** to conclude the process and exit the InstallShield Wizard.

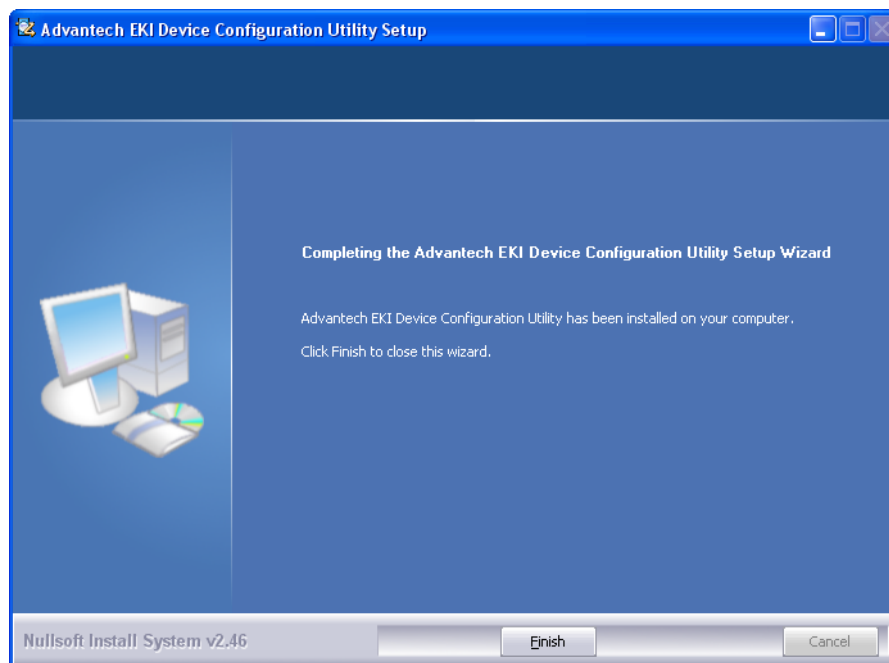

Figure 3-5. InstallShield Wizard 4 of 4

3.4. Utility Menu Map

The EKI Configuration Utility can be installed on different operating systems, however, Windows 7 is the recommended version.

Click **Start > All Programs > EKI Device Configuration Utility > Advantech EKI Device Configuration Utility**. The EKI Device Configuration Utility screen appears, see the following figure.

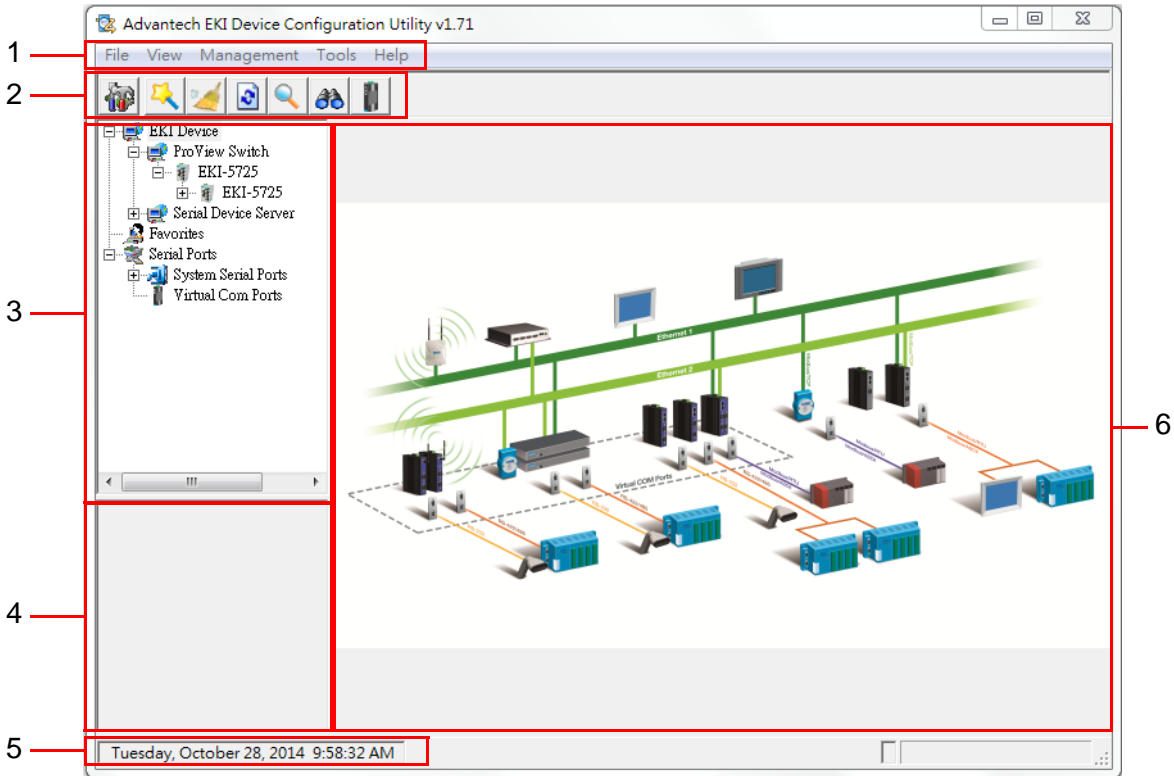

Figure 3-6. Configuration Utility Overview

Table 3-1. Configuration Utility Overview

No	Item	Description
1	Menu Bar	Displays File, View, Management, Tools and Help.
2	Tool Bar	Useful management functions' shortcuts.
3	Tree View	All devices will be searched and listed in this area. You can arrange different favorite group and virtual COM ports.
4	Information Panel	Click on the devices or move cursor to the devices, the related information is shown in this area.
5	Status Bar	Displays the current time.
6	Configuration Area	Click on the items on the TreeView Area, the configuration page displays in this area.

3.5. Menu Bar

3.5.1 View Menu

Utility Settings

Click **View** > **Settings** to configure utility settings.

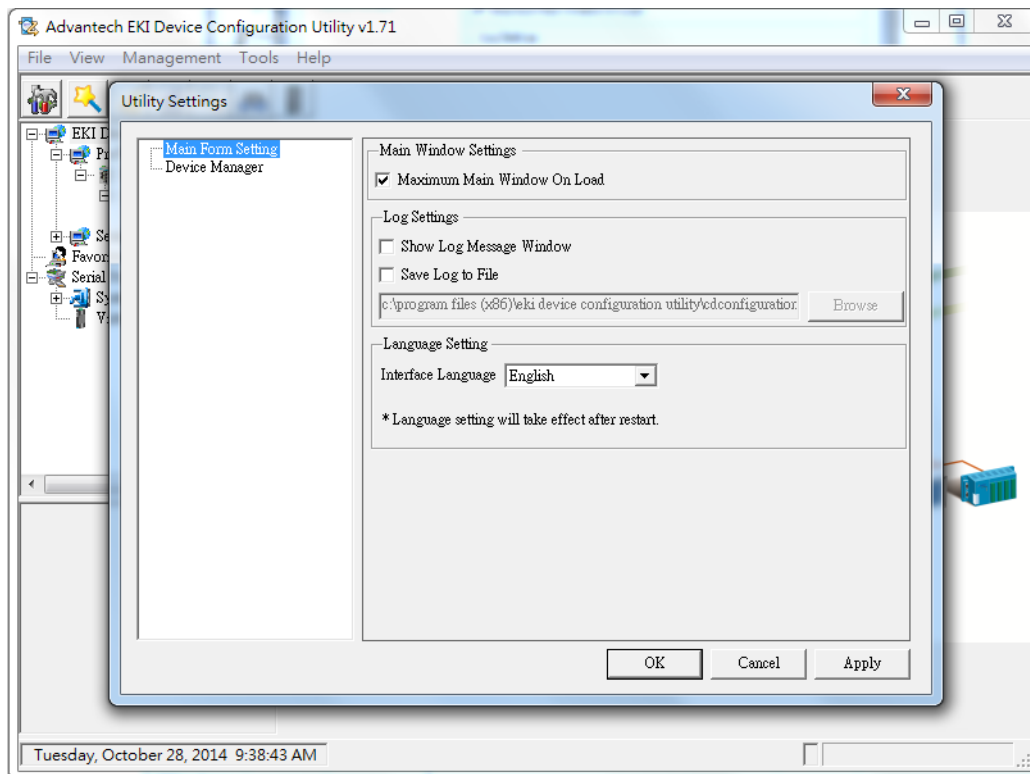

Figure 3-7. View > Settings > Main Form Setting

Table 3-2. Utility Settings > Main Form Setting

Item	Description
Main Window Settings	
Maximum Main Window On Load	Check the box to enable the limiting of main windows on-load to the maximum value.
Log Settings	
Show Log Message Window	Check the checkbox to show the log message.
Save Log to File	Check the checkbox to save log to file.
Browse	Click Browse to choose a file to save.
Language Settings	
Interface Language	Click the drop-down menu to select an interface language: Traditional Chinese, Simplified Chinese or English.

Table 3-2. Utility Settings > Main Form Setting (Continued)

Item	Description
OK	Click OK to save and exit the utility setting.
Cancel	Click Cancel to discard the changes.
Apply	Click Apply to save the utility setting.

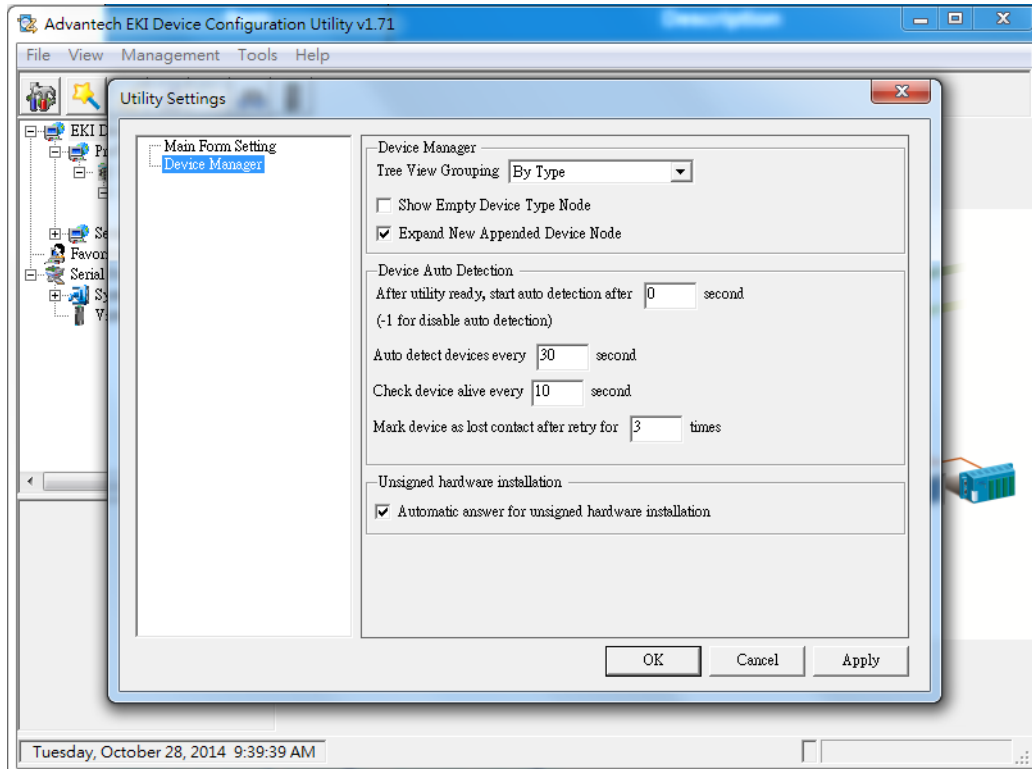

Figure 3-8. View > Settings > Device Manager

Table 3-3. Utility Settings > Device Manager

Item	Description
Device Manager	
Tree View Grouping	Click the drop-down menu to enable or disable grouping.
Show Empty Device Type Node	Check the checkbox to show empty device type node or not.
Expand New Appended Device Node	Check the checkbox to expand a new appended device node or not.
Device Auto Detection	
After utility ready, start auto detection after X second	Enter a value to specify the time to auto detection time (-1 means disable auto detection).
Auto detect devices every X second	Enter a value to specify the time to auto detect devices.

Table 3-3. Utility Settings > Device Manager (Continued)

Item	Description
Check device alive every X second	Enter a value to specify the time to check device alive.
Mark device as lost contact after retry for X times	Enter a value to specify the time to mark device as lost contact.
Unsigned Hardware Installation	
Automatic answer for unsigned hardware installation	Check the checkbox to enable or disable answer automatically for unsigned hardware installation.
OK	Click OK to save and exit the utility setting.
Cancel	Click Cancel to discard the changes.
Apply	Click Apply to save the utility setting.

3.5.2 Management Menu

Table 3-4. Management

Item	Description
Configuration Wizard	Start the software wizard (setup assistant) to leads you through the VCOM configuration process for device server product.
Clear Device List and Search Again	Clear all device list and re-search devices.
Search Again	Re-search devices.
Add IP Address to Favorite	Add one device to Favorites.
Search for a Range of IP Addresses	Add a group of device to Favorites.
Manual Direct Mapping Virtual COM Port	Click to add a target by selecting a Device Type and inputting the IP address, physically connecting the serial device server to the network is not required.

3.5.3 Help Menu







Table 3-5. Help

Item	Description
Check Utility Update	Select to update configuration utility.
About	Select to show the information about the configuration utility.

3.6. Tool Bar

The tool bar is a list of shortcuts for the most frequently used menu functions. Icons are provided for each function. By clicking on the icon, the most frequently used functions can be accessed.

Table 3-6. Tool Bar

Icon	Item	Description
	Utility Settings	Refer to “Utility Settings” on page 54.
	Configuration Wizard	Refer to “Management Menu” on page 56.
	Clear Device List and Search Again	Refer to “Management Menu” on page 56.
	Auto Search (Search Again)	Refer to “Management Menu” on page 56.
	Add IP Address to Favorite	Refer to “Management Menu” on page 56.
	Search for a Range of IP Addresses	Refer to “Management Menu” on page 56.
	Manual Direct Mapping Virtual COM Port	Refer to “Management Menu” on page 56.

3.7. TreeView

The TreeView configuration area displays the selected device’s configurable settings. From this area you can directly group devices in the favorite’s list. See “Utility Menu Map” on page 53.

3.8. Information Panel

The Information Panel area displays the selected device’s related information. See “Utility Menu Map” on page 53.

3.9. Status Bar

The Status Bar area displays the current time. See “Utility Menu Map” on page 53.

3.10. Configuration Area

The Configuration Area displays correlating information from selected menu items within the TreeView area. See “Utility Menu Map” on page 53.

Managing Switch

Chapter 4

4.1. Discovering Switches

4.1.1 First Time Installation

Enabling ProView Function

See “Enabling ProView Function” on page 49 for further information.

Configuring Network Settings

EKI Device Configuration Utility provides two ways to configure network settings: DHCP + Auto IP Settings or Static Settings.

DHCP + Auto IP Settings

1. Select Ethernet under the desired device.
2. Click the drop-down menu to select **DHCP + Auto-IP**.
3. Click **Apply** to confirm the settings.

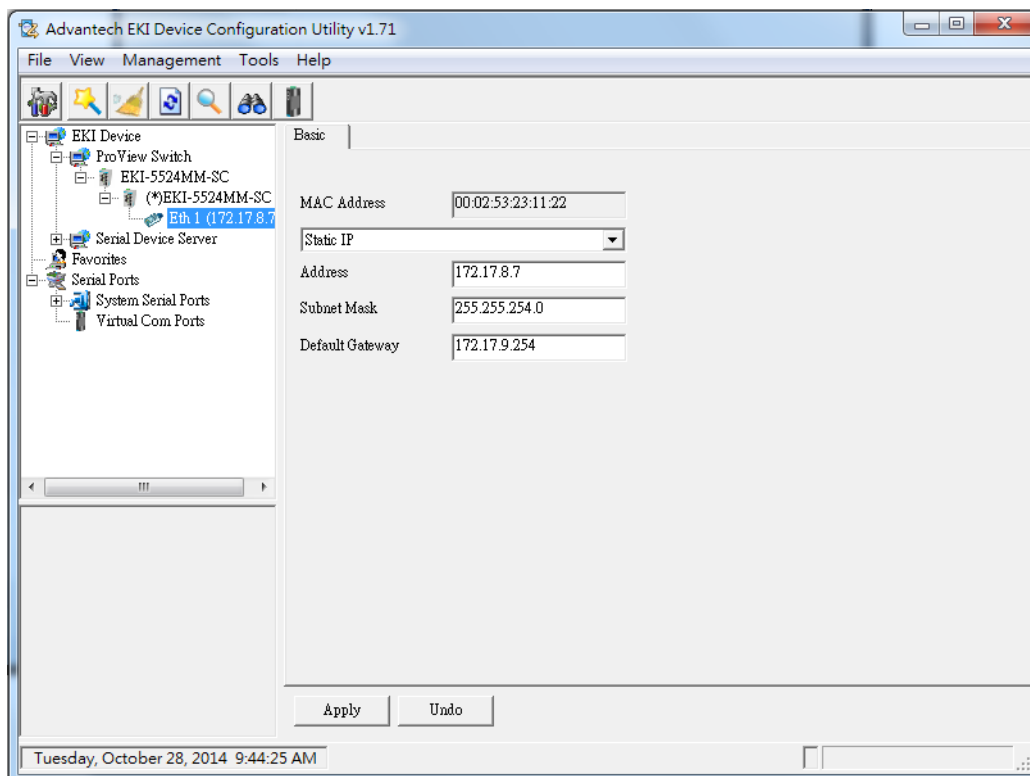

Figure 4-1. Selecting Networking Setting

Static Settings

1. Select Ethernet under the desired device.
2. Click the drop-down menu to select **Static IP**.
3. Enter the IP Address, Subnet Mask and Gateway.

4. Click **Apply** to confirm the settings.

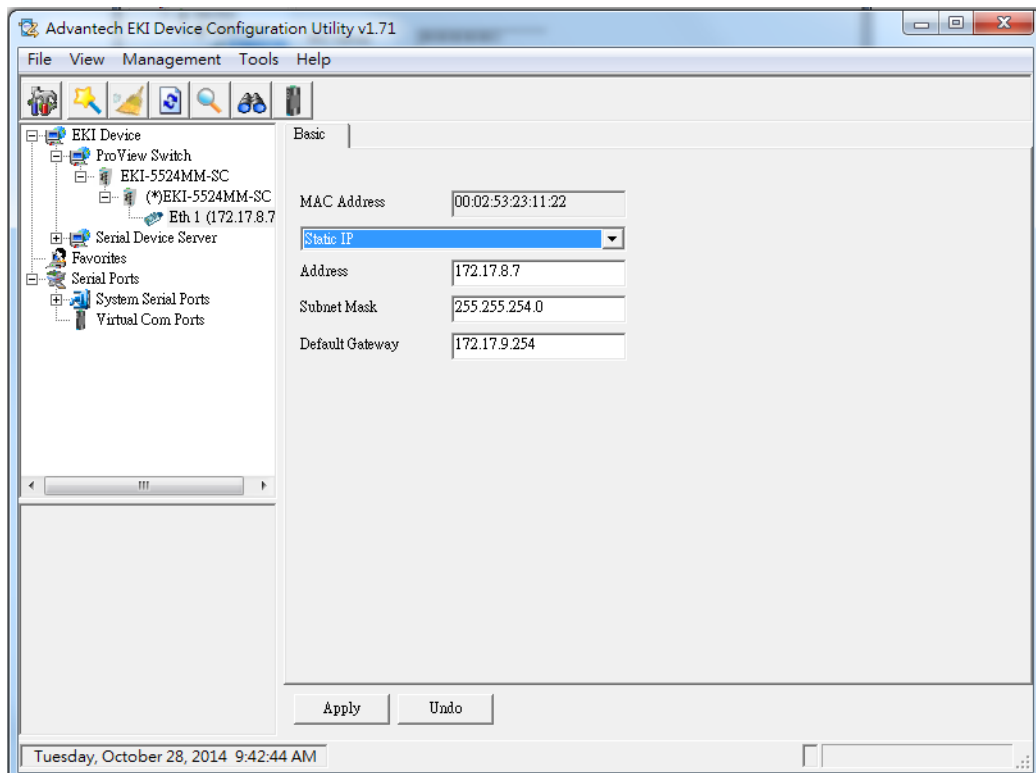

Figure 4-2. Configuring a Static IP Setting

4.1.2 Discovering Switches

Auto Search

Only devices within the same network domain can be listed through the search function. Once a device is listed, the features and configuration details are accessible by clicking on the device name.

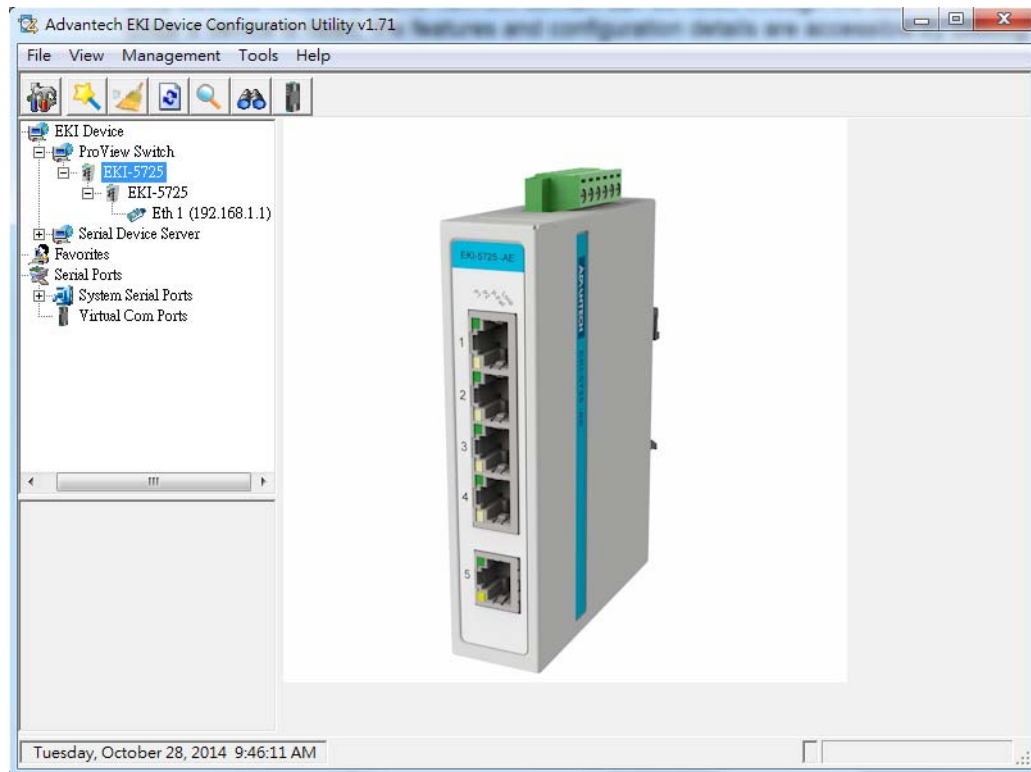



Figure 4-3. Auto Searching Screen

To search for a device:

1. From the Tool Bar, click the **Search Again**  button.

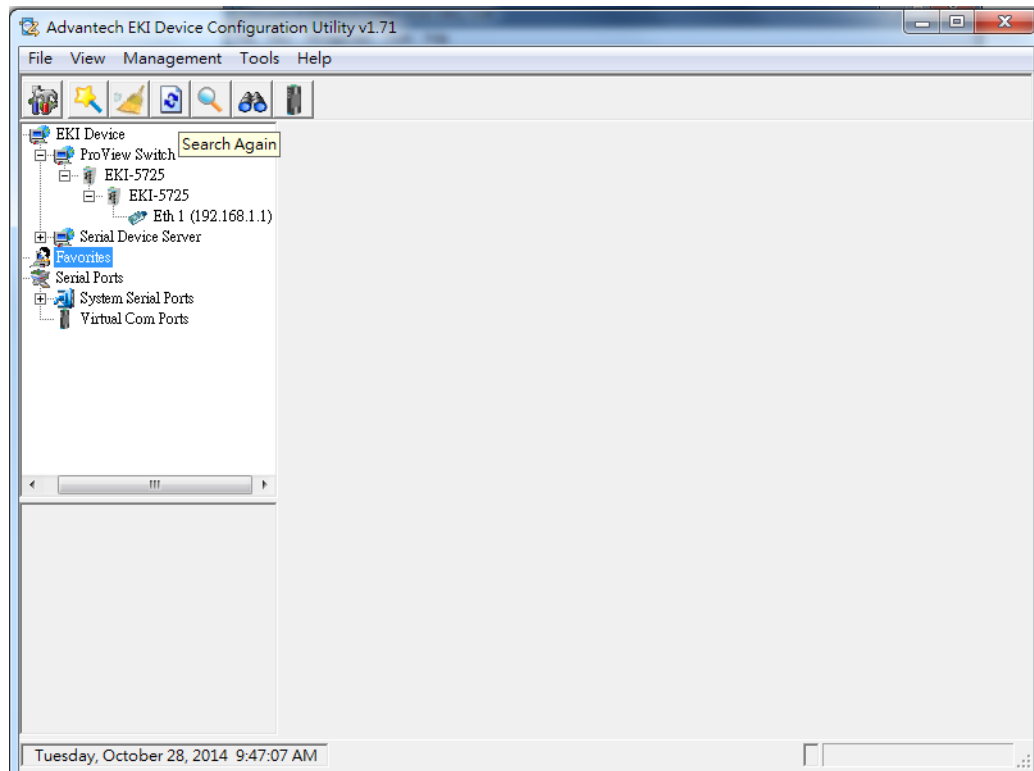



Figure 4-4. Selecting Search Again



Access to the utility's full function list requires administrator privileges.

Clearing Device List and Search Again

The search list can be cleared for a new search request by clicking the **Clearing Device List and Search Again**  button. The function clears the listing of the devices. You can use the Search function again to detect any devices connected to the network domain.

4.1.3 Group Management

Creating Groups

Groups are best used to identify a set of devices with a common characteristic and to better organize the device pool.

To create a favorite group, please follow the instructions as follows:

1. Right-click Favorite to display the settings.
2. Select **Create Group** to enter group name.

3. Enter a group name and click **OK**.

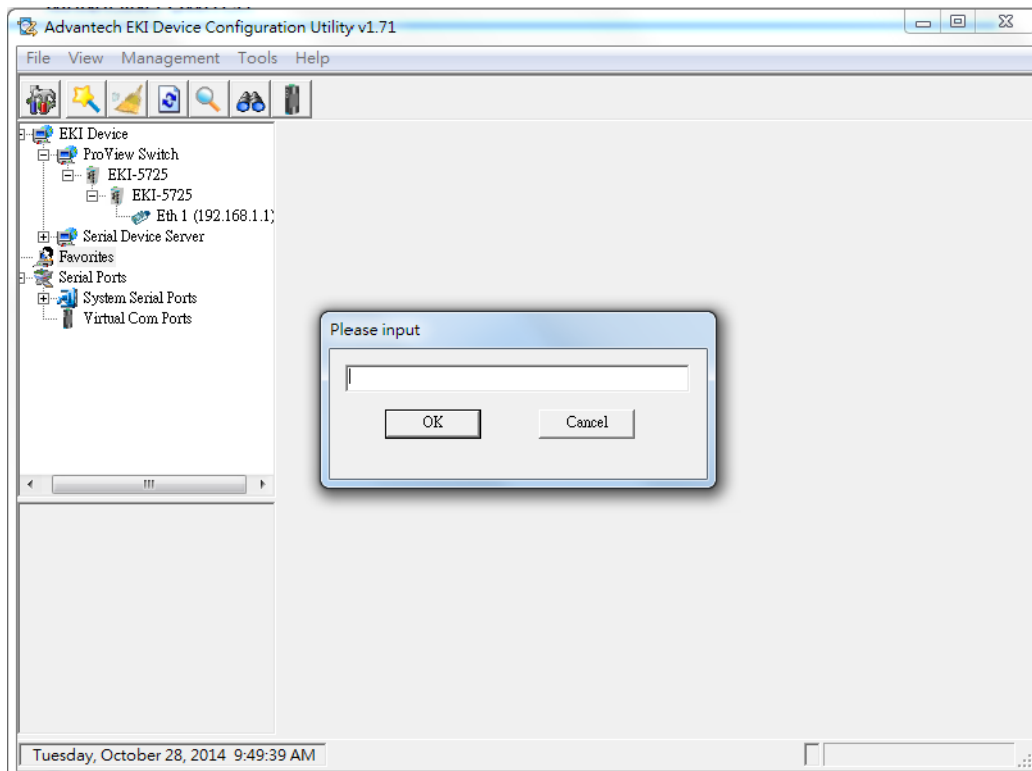

Figure 4-5. Adding a Group

The group is created and is available in the Favorite's List.

Favorite's List

A favorite's list is simple a way to organize the available devices by a category.

There are three ways to create a favorite's list: selecting a device, selecting an IP address, and selecting an IP address range. The following guidelines allow you to create a favorite's list.

Adding a Device

1. Right-click a desired device to display the settings menu.
2. Select **Add to Favorite**.

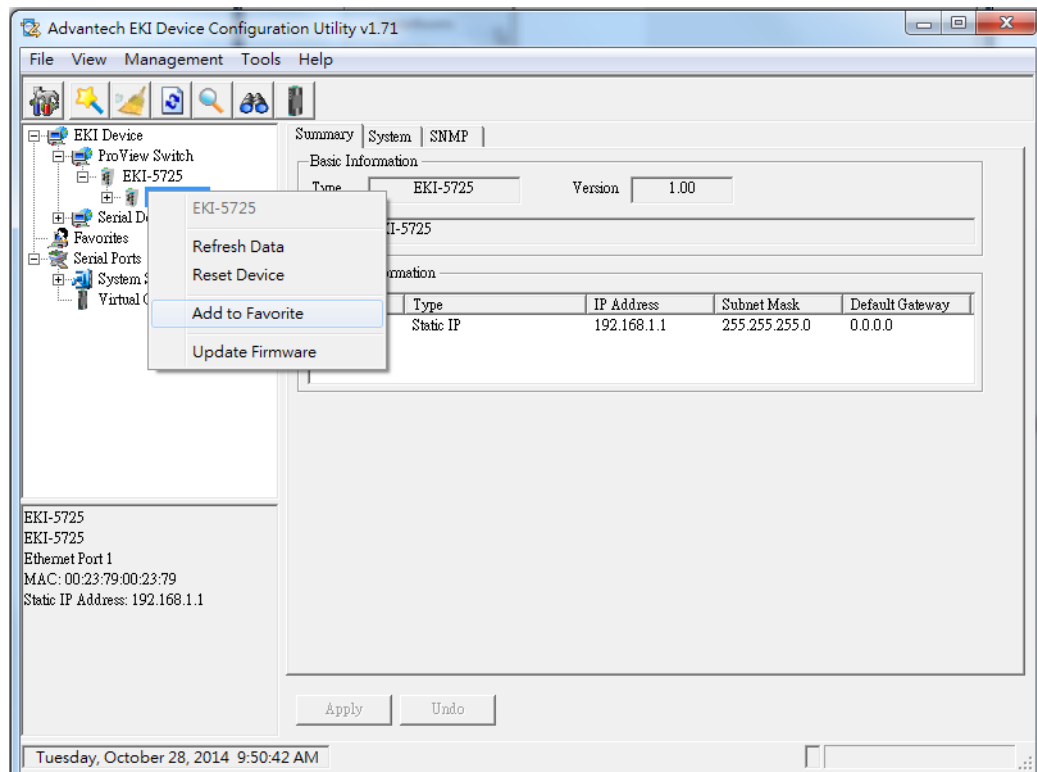



Figure 4-6. Adding a Switch to Favorites

In the event that there are existing groups, you can select the specific favorite group to include the selected device.

Adding an IP Address

1. From the Tool Bar, click the **Add IP Address to Favorite**  button.
2. Enter an IP address.
3. Click **OK** to add the IP address into the favorites list

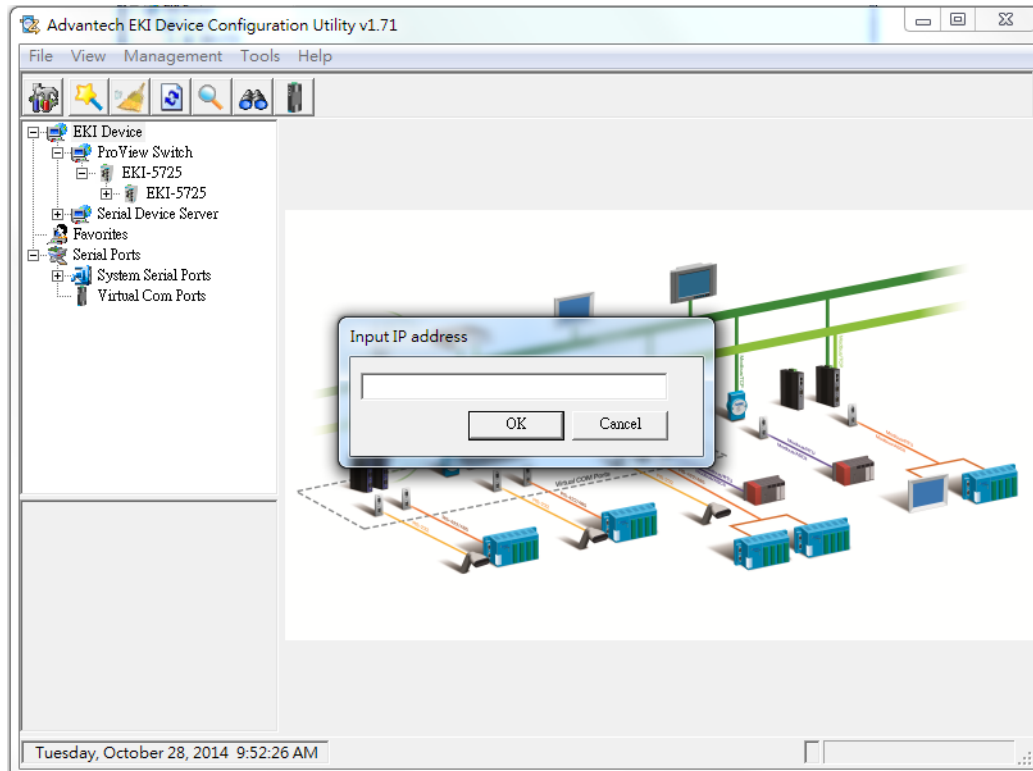



Figure 4-7. Add Favorite

In the event that there are existing groups, you can select the specific favorite group to include the selected IP address.

Adding an IP Address Range

1. From the Tool Bar, click the **Search for a Range of IP Addresses**  button.
2. Enter a starting and ending IP address range.
3. Click **OK** to add the range into the favorites list.

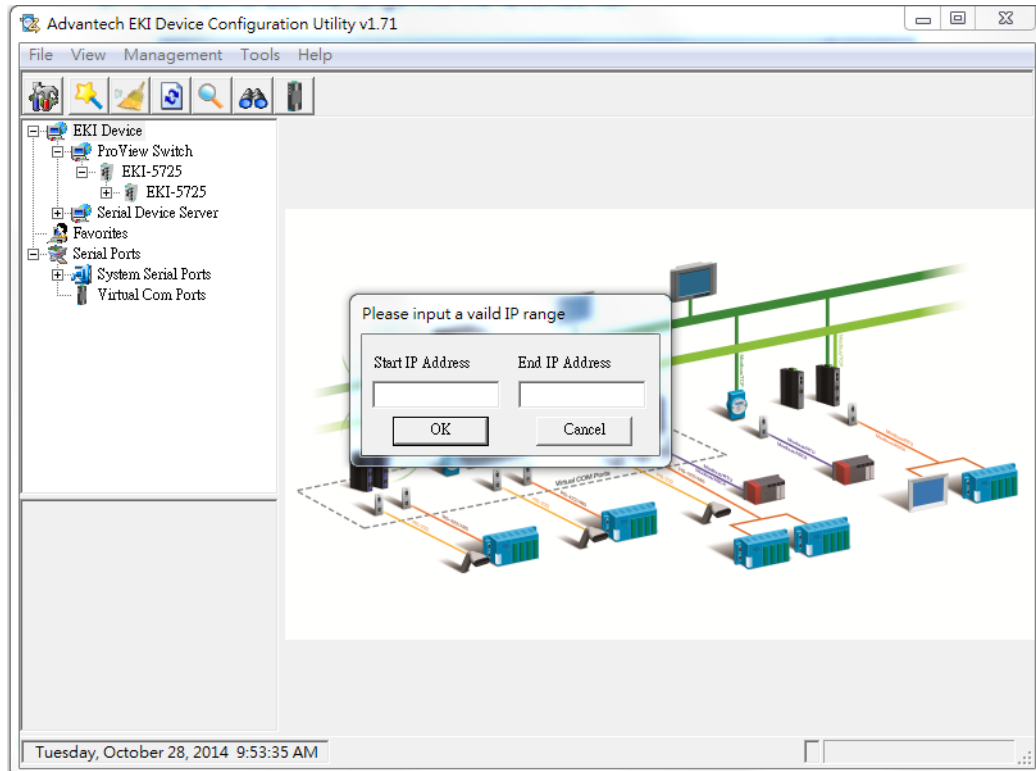

Figure 4-8. Add Favorite

In the event that there are existing groups, you can select the specific favorite group to include the selected IP address range.

4.1.4 Configuring the System

Changing Device Name

1. Select the device to configure by clicking on it.
2. In the Configuration Area, select **System** tab.
3. Locate the **Device Name** field, and enter a device name.
4. Click **Apply** to configure the device.

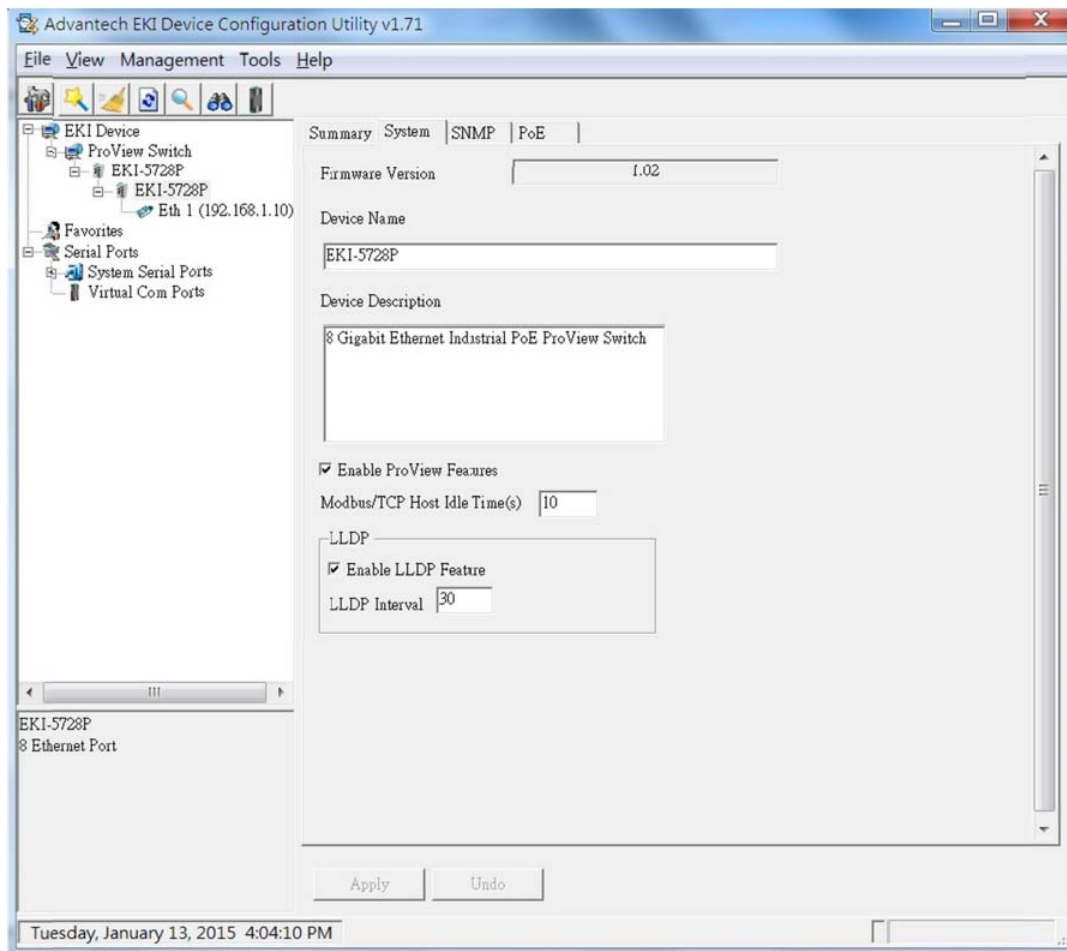

Figure 4-9. Changing Device Name

The device name is changed.

Setting Modbus/TCP Idle Time

1. Select the device to configure by clicking on it.
2. In the Configuration Area, select the **System** tab.
3. Locate the **Modbus/TCP Host Idle Time(s)** field.
4. Enter a variable representing the idle time for the Modbus/TCP host function.
ProView provides the following information to SCADA through Modbus/TCP.
 - Vendor Name
 - Production Name

- Firmware Version
 - Ethernet MAC Address
 - IP Address
 - Port Status
 - Port Speed
 - Flow Control
 - Port Description
 - Link Up Counter
 - PoE Status
 - Tx Packets Counter
 - Rx Packets Counter
 - Tx Error Packets Counter
 - Rx Error Packets Counter
5. Click **Apply** to configure the function.

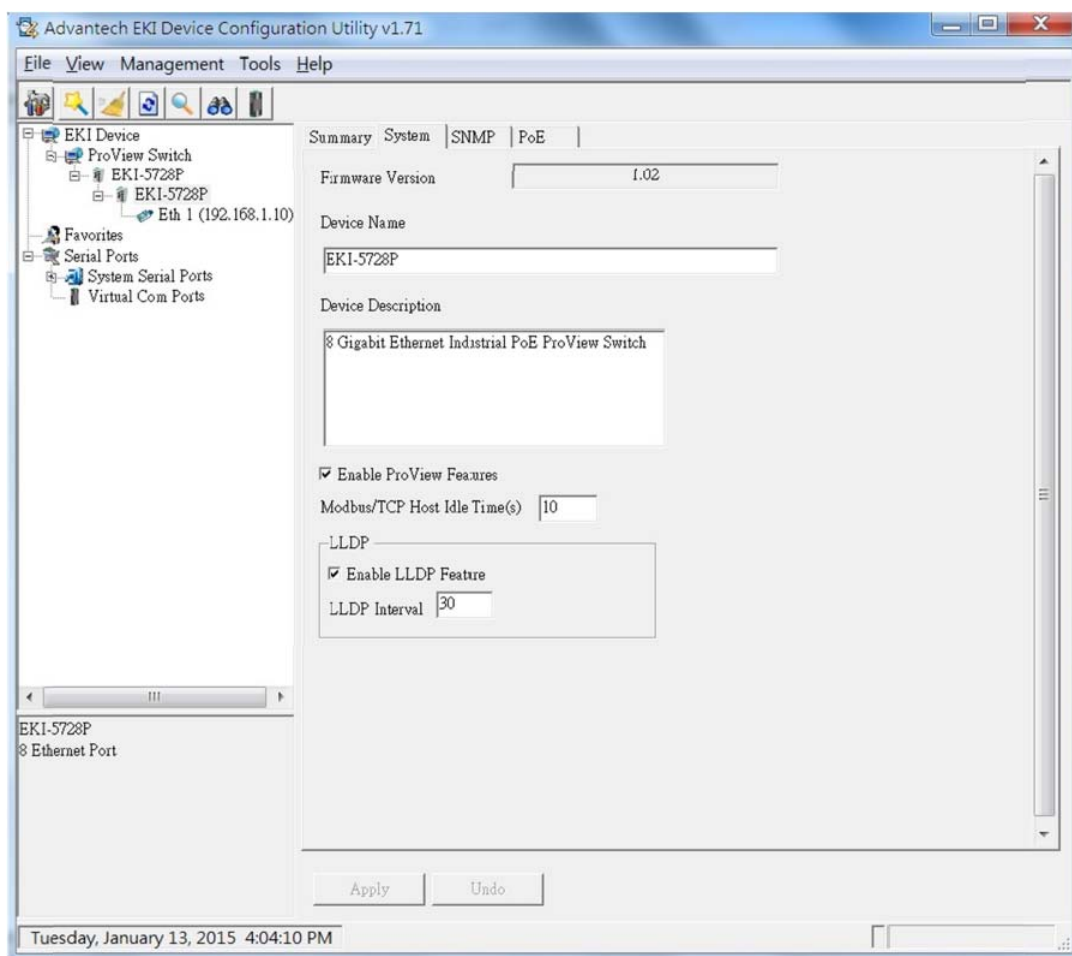

Figure 4-10. Setting Modbus/TCP Idle Time

The Modbus/TCP idle time is now set.

Setting LLDP

1. Select the device to configure by clicking on it.
2. In the Configuration Area, select the **System** tab.
3. Under LLDP, check **Enable LLDP Feature** to enable the LLDP feature. This feature is used by the device to advertise its identity, capabilities, and neighbors throughout the network.
4. Enter a variable representing the idle time for sending of LLDP information.

Setting Networks Parameters

For setting networks parameters, see “Configuring Network Settings” on page 59.

Setting SNMP

1. Select the device to configure by clicking on it.
2. In the Configuration Area, select **SNMP** tab.
The Basic and Community settings are listed for configuration.
3. In the SNMP Basic Settings selection, enter a contact and location in the respective fields.
4. In the SNMP Community Settings selection, the read-only and read-write strings are required.
5. In the SNMP Trap Setting selection, enter the IP address of the SNMP trap server.

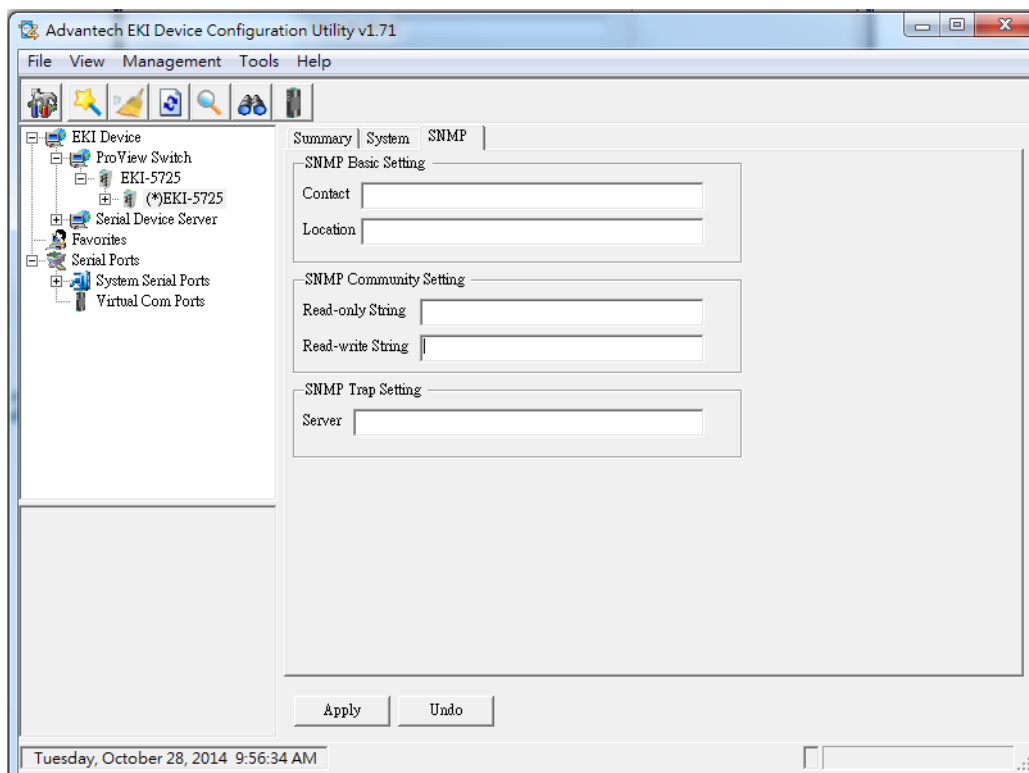

Figure 4-11. Setting SNMP

Setting PoE

1. Select the device to configure by clicking on it.
2. In the Configuration Area, select the **PoE** tab.
3. Select the radio-box next to the target port then click on it to check and enable the PoE function on that port. To disable the PoE function on the port, click on the radio-box to unselect it.
4. Click **Refresh** to update the PoE status for each port. Each port displays the current enabled or disabled state in addition to the following information.
 - Voltage (V)
 - Current (mA)
 - Power (W)
 - Temperature (Celsius)

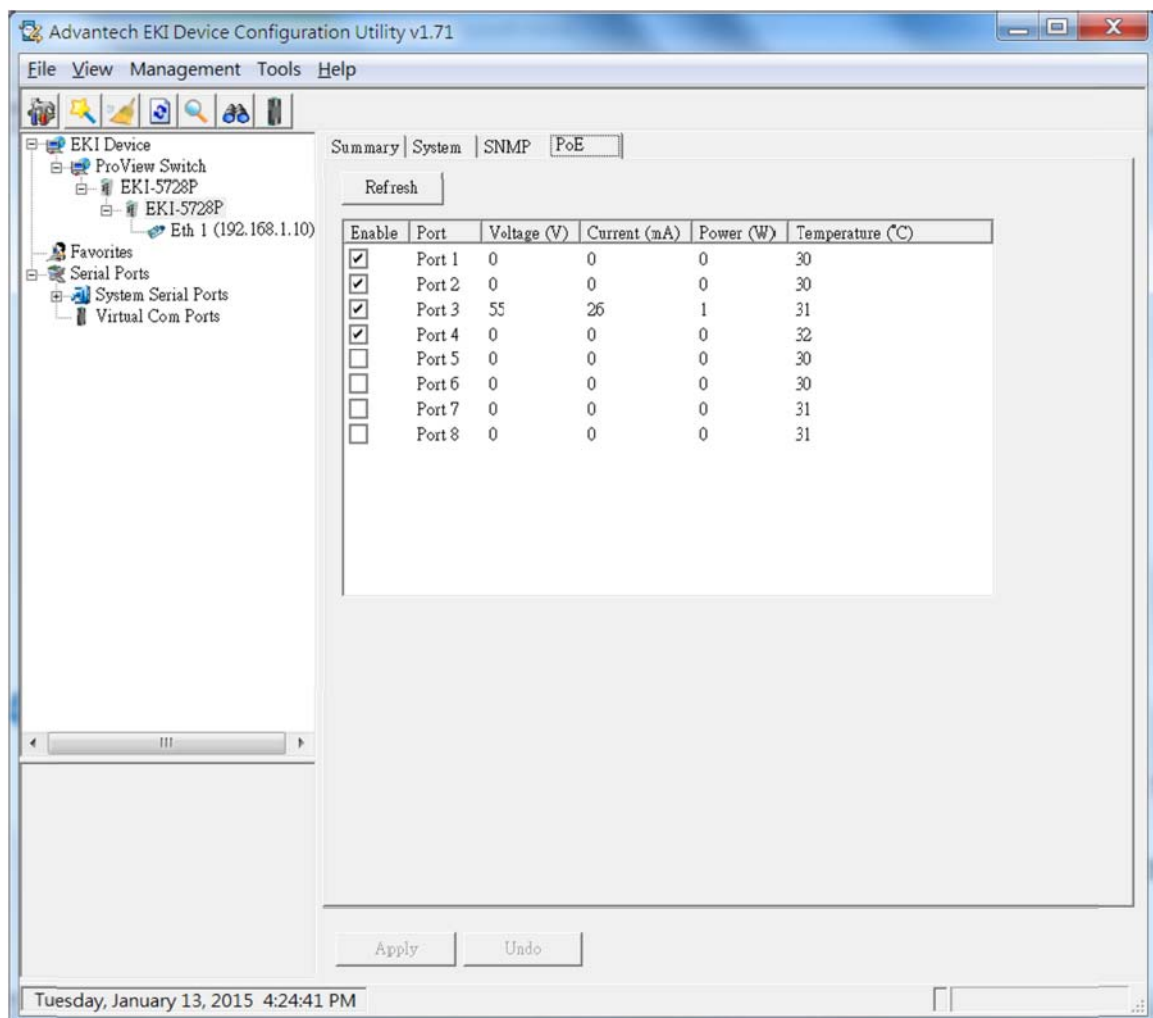

Figure 4-12. Setting Modbus/TCP Idle Time

4.2. Modbus/TCP Mapping

The data map addresses of Advantech switches shown in the following table start from Modbus address 30001 for function code 4.

In the given example, the address offset 0x1000 (hex) equals Modbus address 34097, while the address offset 0x1100 (hex) equals Modbus address 34353.

The information given by the Advantech is shown in hex mode.

4.2.1 Modbus/TCP Mapping Table

Table 4-1. Modbus/TCP Mapping Table

Catelog	Name	Data Type		Inter-pretation	Address Offset (Hex)	Address 3X	Description
System Info	Vendor ID = 0x'13FE	1 word	16 bits	HEX	0x0000	30001	Vendor ID = 0x13FE
	Unit ID = 0xFF	1 word	16 bits	HEX	0x0001	30002	Unit ID = 0xFF
	Product Code	1 word	16 bits	HEX	0x0002	30003	Product Code

Table 4-1. Modbus/TCP Mapping Table (Continued)

Catelog	Name	Data Type		Inter-pretation	Address Offset (Hex)	Address 3X	Description
System Info	Vendor Name = "Advantech"	16 words	32 chars	ASCII	0x0010	30017	Vendor Name = "Advantech" Word 0 Hi byte = 'A' Word 0 Lo byte = 'd' Word 1 Hi byte = 'v' Word 1 Lo byte = 'a' Word 2 Hi byte = 'n' Word 2 Lo byte = 't' Word 3 Hi byte = 'e' Word 3 Lo byte = 'c' Word 4 Hi byte = 'h' Word 4 Lo byte = '\0'
	Product Name = "EKI-xxxx"	16 words	32 chars	ASCII	0x0020	30033	Product Name = "EKI-xxxx" Word 0 Hi byte = 'E' Word 0 Lo byte = 'K' Word 1 Hi byte = 'I' Word 1 Lo byte = '-' Word 2 Hi byte = 'x' Word 2 Lo byte = 'x' Word 3 Hi byte = 'x' Word 3 Lo byte = 'x' Word 4 Hi byte = '\0'
	Firmware Version	2 words	32 bits	HEX	0x020A	30523	Firmware Version Word 0 Hi byte = major Word 0 Lo byte = minor Word 1 Hi byte = release Word 1 Lo byte = build
	Ethernet MAC Address	3 words	48 bits	HEX	0x020E	30527	Ethernet MAC Address Ex: MAC = 00-19-CB-01-02-03 Word 0 Hi byte = 0x00 Word 0 Lo byte = 0x19 Word 1 Hi byte = 0xCB Word 1 Lo byte = 0x01 Word 2 Hi byte = 0x02 Word 2 Lo byte = 0x03

Table 4-1. Modbus/TCP Mapping Table (Continued)

Catalog	Name	Data Type		Inter-pretation	Address Offset (Hex)	Address 3X	Description
System Info	Revision Number	16 words	32 chars	ASCII	0x0211	30530	Product Name = "YYY.xxxxx" Word 0 Hi byte = 'Y' Word 0 Lo byte = 'Y' Word 1 Hi byte = 'Y' Word 1 Lo byte = '.' Word 2 Hi byte = 'x' Word 2 Lo byte = 'x' Word 3 Hi byte = 'x' Word 3 Lo byte = 'x' Word 4 Hi byte = 'x' Word 4 Lo byte = '0'
	IP Address	2 words	32 bits	HEX	0x0400	31025	IP Address Ex: IP = 192.168.1.1 Word 0 Hi byte = 0xC0 Word 0 Lo byte = 0xA8 Word 1 Hi byte = 0x01 Word 1 Lo byte = 0x01
Port Info	Port Status	1 word	16 bits	HEX	0x1000 ~ 0x101F	34097 ~ 34128	Port Status 0x0000: Link down 0x0001: Link up 0xFFFF: No port
	Port 1 Status	1 word	16 bits	HEX	0x1000	34097	
	Port 2 Status	1 word	16 bits	HEX	0x1001	34098	
	Port 3 Status	1 word	16 bits	HEX	0x1002	34099	
	Port 4 Status	1 word	16 bits	HEX	0x1003	34100	
	Port 5 Status	1 word	16 bits	HEX	0x1004	34101	
	Port 6 Status	1 word	16 bits	HEX	0x1005	34102	
	Port 7 Status	1 word	16 bits	HEX	0x1006	34103	
	Port 8 Status	1 word	16 bits	HEX	0x1007	34104	
	Port 9 Status	1 word	16 bits	HEX	0x1008	34105	
	Port 10 Status	1 word	16 bits	HEX	0x1009	34106	
	Port 11 Status	1 word	16 bits	HEX	0x100A	34107	
	Port 12 Status	1 word	16 bits	HEX	0x100B	34108	

Table 4-1. Modbus/TCP Mapping Table (Continued)

Catalog	Name	Data Type		Inter-pretation	Address Offset (Hex)	Address 3X	Description
Port Info	Port 13 Status	1 word	16 bits	HEX	0x100C	34109	
	Port 14 Status	1 word	16 bits	HEX	0x100D	34110	
	Port 15 Status	1 word	16 bits	HEX	0x100E	34111	
	Port 16 Status	1 word	16 bits	HEX	0x100F	34112	
	Port 17 Status	1 word	16 bits	HEX	0x1010	34113	
	Port 18 Status	1 word	16 bits	HEX	0x1011	34114	
	Port 19 Status	1 word	16 bits	HEX	0x1012	34115	
	Port 20 Status	1 word	16 bits	HEX	0x1013	34116	
	Port 21 Status	1 word	16 bits	HEX	0x1014	34117	
	Port 22 Status	1 word	16 bits	HEX	0x1015	34118	
	Port 23 Status	1 word	16 bits	HEX	0x1016	34119	
	Port 24 Status	1 word	16 bits	HEX	0x1017	34120	
	Port 25 Status	1 word	16 bits	HEX	0x1018	34121	
	Port 26 Status	1 word	16 bits	HEX	0x1019	34122	
	Port 27 Status	1 word	16 bits	HEX	0x101A	34123	
	Port 28 Status	1 word	16 bits	HEX	0x101B	34124	
	Port 29 Status	1 word	16 bits	HEX	0x101C	34125	
Port 30 Status	1 word	16 bits	HEX	0x101D	34126		
Port 31 Status	1 word	16 bits	HEX	0x101E	34127		
Port 32 Status	1 word	16 bits	HEX	0x101F	34128		

Table 4-1. Modbus/TCP Mapping Table (Continued)

Catalog	Name	Data Type		Interpretation	Address Offset (Hex)	Address 3X	Description
Port Info	Port Speed	1 word	16 bits	HEX	0x1100 ~ 0x111F	34353 ~ 34384	Port Speed 0x0000: 10M-Half 0x0001: 10M-Full 0x0002: 100M-Half 0x0003: 100M-Full 0x0004: 1000M-Half 0x0005: 1000M-Full 0xFFFF: No port
	Port 1 Speed	1 word	16 bits	HEX	0x1100	34353	
	Port 2 Speed	1 word	16 bits	HEX	0x1101	34354	
	Port 3 Speed	1 word	16 bits	HEX	0x1102	34355	
	Port 4 Speed	1 word	16 bits	HEX	0x1103	34356	
	Port 5 Speed	1 word	16 bits	HEX	0x1104	34357	
	Port 6 Speed	1 word	16 bits	HEX	0x1105	34358	
	Port 7 Speed	1 word	16 bits	HEX	0x1106	34359	
	Port 8 Speed	1 word	16 bits	HEX	0x1107	34360	
	Port 9 Speed	1 word	16 bits	HEX	0x1108	34361	
	Port 10 Speed	1 word	16 bits	HEX	0x1109	34362	
	Port 11 Speed	1 word	16 bits	HEX	0x110A	34363	
	Port 12 Speed	1 word	16 bits	HEX	0x110B	34364	
	Port 13 Speed	1 word	16 bits	HEX	0x110C	34365	
	Port 14 Speed	1 word	16 bits	HEX	0x110D	34366	
	Port 15 Speed	1 word	16 bits	HEX	0x110E	34367	
	Port 16 Speed	1 word	16 bits	HEX	0x110F	34368	
	Port 17 Speed	1 word	16 bits	HEX	0x1110	34369	
	Port 18 Speed	1 word	16 bits	HEX	0x1111	34370	
Port 19 Speed	1 word	16 bits	HEX	0x1112	34371		

Table 4-1. Modbus/TCP Mapping Table (Continued)

Catelog	Name	Data Type		Inter-pretation	Address Offset (Hex)	Address 3X	Description
Port Info	Port 20 Speed	1 word	16 bits	HEX	0x1113	34372	
	Port 21 Speed	1 word	16 bits	HEX	0x1114	34373	
	Port 22 Speed	1 word	16 bits	HEX	0x1115	34374	
	Port 23 Speed	1 word	16 bits	HEX	0x1116	34375	
	Port 24 Speed	1 word	16 bits	HEX	0x1117	34376	
	Port 25 Speed	1 word	16 bits	HEX	0x1118	34377	
	Port 26 Speed	1 word	16 bits	HEX	0x1119	34378	
	Port 27 Speed	1 word	16 bits	HEX	0x111A	34379	
	Port 28 Speed	1 word	16 bits	HEX	0x111B	34380	
	Port 29 Speed	1 word	16 bits	HEX	0x111C	34381	
	Port 30 Speed	1 word	16 bits	HEX	0x111D	34382	
	Port 31 Speed	1 word	16 bits	HEX	0x111E	34383	
	Port 32 Speed	1 word	16 bits	HEX	0x111F	34384	
	Flow Control	1 word	16 bits	HEX	0x1200 ~ 0x121F	34609 ~ 34640	Flow Control 0x0000: Off 0x0001: On 0xFFFF: No port
	Port 1 Flow Control	1 word	16 bits	HEX	0x1200	34609	
	Port 2 Flow Control	1 word	16 bits	HEX	0x1201	34610	
	Port 3 Flow Control	1 word	16 bits	HEX	0x1202	34611	
	Port 4 Flow Control	1 word	16 bits	HEX	0x1203	34612	
	Port 5 Flow Control	1 word	16 bits	HEX	0x1204	34613	

Table 4-1. Modbus/TCP Mapping Table (Continued)

Catalog	Name	Data Type		Inter-pretation	Address Offset (Hex)	Address 3X	Description
Port Info	Port 6 Flow Control	1 word	16 bits	HEX	0x1205	34614	
	Port 7 Flow Control	1 word	16 bits	HEX	0x1206	34615	
	Port 8 Flow Control	1 word	16 bits	HEX	0x1207	34616	
	Port 9 Flow Control	1 word	16 bits	HEX	0x1208	34617	
	Port 10 Flow Control	1 word	16 bits	HEX	0x1209	34618	
	Port 11 Flow Control	1 word	16 bits	HEX	0x120A	34619	
	Port 12 Flow Control	1 word	16 bits	HEX	0x120B	34620	
	Port 13 Flow Control	1 word	16 bits	HEX	0x120C	34621	
	Port 14 Flow Control	1 word	16 bits	HEX	0x120D	34622	
	Port 15 Flow Control	1 word	16 bits	HEX	0x120E	34623	
	Port 16 Flow Control	1 word	16 bits	HEX	0x120F	34624	
	Port 17 Flow Control	1 word	16 bits	HEX	0x1210	34625	
	Port 18 Flow Control	1 word	16 bits	HEX	0x1211	34626	
	Port 19 Flow Control	1 word	16 bits	HEX	0x1212	34627	
	Port 20 Flow Control	1 word	16 bits	HEX	0x1213	34628	
	Port 21 Flow Control	1 word	16 bits	HEX	0x1214	34629	
	Port 22 Flow Control	1 word	16 bits	HEX	0x1215	34630	
	Port 23 Flow Control	1 word	16 bits	HEX	0x1216	34631	
	Port 24 Flow Control	1 word	16 bits	HEX	0x1217	34632	
	Port 25 Flow Control	1 word	16 bits	HEX	0x1218	34633	

Table 4-1. Modbus/TCP Mapping Table (Continued)

Catalog	Name	Data Type		Inter-pretation	Address Offset (Hex)	Address 3X	Description
Port Info	Port 26 Flow Control	1 word	16 bits	HEX	0x1219	34634	
	Port 27 Flow Control	1 word	16 bits	HEX	0x121A	34635	
	Port 28 Flow Control	1 word	16 bits	HEX	0x121B	34636	
	Port 29 Flow Control	1 word	16 bits	HEX	0x121C	34637	
	Port 30 Flow Control	1 word	16 bits	HEX	0x121D	34638	
	Port 31 Flow Control	1 word	16 bits	HEX	0x121E	34639	
	Port 32 Flow Control	1 word	16 bits	HEX	0x121F	34640	
	Port Description	20 words	40 chars	ASCII	0x1400 ~ 0x166C	35121 ~ 35741	Port Description Port Description = "100RX,RJ45." Word 0 Hi byte = '1' Word 0 Lo byte = '0' Word 1Hi byte = '0' Word 1 Lo byte = 'R' Word 2 Hi byte = 'X' Word 2 Lo byte = ',' Word 3 Hi byte = 'R' Word 3 Lo byte = 'J' Word 4 Hi byte = '4' Word 4 Lo byte = '5' Word 5 Hi byte = '.' Word 5 Lo byte = '\0'
	Port 1 Description	20 words	40 chars	ASCII	0x1400	35121	
	Port 2 Description	20 words	40 chars	ASCII	0x1414	35141	
	Port 3 Description	20 words	40 chars	ASCII	0x1428	35161	
	Port 4 Description	20 words	40 chars	ASCII	0x143C	35181	
	Port 5 Description	20 words	40 chars	ASCII	0x1450	35201	

Table 4-1. Modbus/TCP Mapping Table (Continued)

Catalog	Name	Data Type		Inter-pretation	Address Offset (Hex)	Address 3X	Description
Port Info	Port 6 Description	20 words	40 chars	ASCII	0x1464	35221	
	Port 7 Description	20 words	40 chars	ASCII	0x1478	35241	
	Port 8 Description	20 words	40 chars	ASCII	0x148C	35261	
	Port 9 Description	20 words	40 chars	ASCII	0x14A0	35281	
	Port 10 Description	20 words	40 chars	ASCII	0x14B4	35301	
	Port 11 Description	20 words	40 chars	ASCII	0x14C8	35321	
	Port 12 Description	20 words	40 chars	ASCII	0x14DC	35341	
	Port 13 Description	20 words	40 chars	ASCII	0x14F0	35361	
	Port 14 Description	20 words	40 chars	ASCII	0x1504	35381	
	Port 15 Description	20 words	40 chars	ASCII	0x1518	35401	
	Port 16 Description	20 words	40 chars	ASCII	0x152C	35421	
	Port 17 Description	20 words	40 chars	ASCII	0x1540	35441	
	Port 18 Description	20 words	40 chars	ASCII	0x1554	35461	
	Port 19 Description	20 words	40 chars	ASCII	0x1568	35481	
	Port 20 Description	20 words	40 chars	ASCII	0x157C	35501	
	Port 21 Description	20 words	40 chars	ASCII	0x1590	35521	
	Port 22 Description	20 words	40 chars	ASCII	0x15A4	35541	
	Port 23 Description	20 words	40 chars	ASCII	0x15B8	35561	
	Port 24 Description	20 words	40 chars	ASCII	0x15CC	35581	
	Port 25 Description	20 words	40 chars	ASCII	0x15E0	35601	

Table 4-1. Modbus/TCP Mapping Table (Continued)

Catelog	Name	Data Type		Inter-pretation	Address Offset (Hex)	Address 3X	Description
Port Info	Port 26 Description	20 words	40 chars	ASCII	0x15F4	35621	
	Port 27 Description	20 words	40 chars	ASCII	0x1608	35641	
	Port 28 Description	20 words	40 chars	ASCII	0x161C	35661	
	Port 29 Description	20 words	40 chars	ASCII	0x1630	35681	
	Port 30 Description	20 words	40 chars	ASCII	0x1644	35701	
	Port 31 Description	20 words	40 chars	ASCII	0x1658	35721	
	Port 32 Description	20 words	40 chars	ASCII	0x166C	35741	
	Link Up Counter	1 word	16 bits	HEX	0x1700 ~ 0x171F	35889 ~ 35920	Link Up Counter Ex: port link up counter = 13 Received MODBUS response: 0x000D
	Port 1 Link Up Counter	1 word	16 bits	HEX	0x1700	35889	
	Port 2 Link Up Counter	1 word	16 bits	HEX	0x1701	35890	
	Port 3 Link Up Counter	1 word	16 bits	HEX	0x1702	35891	
	Port 4 Link Up Counter	1 word	16 bits	HEX	0x1703	35892	
	Port 5 Link Up Counter	1 word	16 bits	HEX	0x1704	35893	
	Port 6 Link Up Counter	1 word	16 bits	HEX	0x1705	35894	
	Port 7 Link Up Counter	1 word	16 bits	HEX	0x1706	35895	
	Port 8 Link Up Counter	1 word	16 bits	HEX	0x1707	35896	
	Port 9 Link Up Counter	1 word	16 bits	HEX	0x1708	35897	
Port 10 Link Up Counter	1 word	16 bits	HEX	0x1709	35898		
Port 11 Link Up Counter	1 word	16 bits	HEX	0x170A	35899		

Table 4-1. Modbus/TCP Mapping Table (Continued)

Catalog	Name	Data Type		Inter-pretation	Address Offset (Hex)	Address 3X	Description
Port Info	Port 12 Link Up Counter	1 word	16 bits	HEX	0x170B	35900	
	Port 13 Link Up Counter	1 word	16 bits	HEX	0x170C	35901	
	Port 14 Link Up Counter	1 word	16 bits	HEX	0x170D	35902	
	Port 15 Link Up Counter	1 word	16 bits	HEX	0x170E	35903	
	Port 16 Link Up Counter	1 word	16 bits	HEX	0x170F	35904	
	Port 17 Link Up Counter	1 word	16 bits	HEX	0x1710	35905	
	Port 18 Link Up Counter	1 word	16 bits	HEX	0x1711	35906	
	Port 19 Link Up Counter	1 word	16 bits	HEX	0x1712	35907	
	Port 20 Link Up Counter	1 word	16 bits	HEX	0x1713	35908	
	Port 21 Link Up Counter	1 word	16 bits	HEX	0x1714	35909	
	Port 22 Link Up Counter	1 word	16 bits	HEX	0x1715	35910	
	Port 23 Link Up Counter	1 word	16 bits	HEX	0x1716	35911	
	Port 24 Link Up Counter	1 word	16 bits	HEX	0x1717	35912	
	Port 25 Link Up Counter	1 word	16 bits	HEX	0x1718	35913	
	Port 26 Link Up Counter	1 word	16 bits	HEX	0x1719	35914	
	Port 27 Link Up Counter	1 word	16 bits	HEX	0x171A	35915	
	Port 28 Link Up Counter	1 word	16 bits	HEX	0x171B	35916	
	Port 29 Link Up Counter	1 word	16 bits	HEX	0x171C	35917	
	Port 30 Link Up Counter	1 word	16 bits	HEX	0x171D	35918	
	Port 31 Link Up Counter	1 word	16 bits	HEX	0x171E	35919	

Table 4-1. Modbus/TCP Mapping Table (Continued)

Catalog	Name	Data Type		Inter-pretation	Address Offset (Hex)	Address 3X	Description
Port Info	Port 32 Link Up Counter	1 word	16 bits	HEX	0x171F	35920	
	PoE Voltage	1 word	16 bits	HEX	0x1800 ~ 0x181F	36145 ~ 36176	PoE Voltage (V) Ex: poe voltage = 5 Received MODBUS response: 0x0005
	Port 1 PoE Voltage	1 word	16 bits	HEX	0x1800	36145	
	Port 2 PoE Voltage	1 word	16 bits	HEX	0x1801	36146	
	Port 3 PoE Voltage	1 word	16 bits	HEX	0x1802	36147	
	Port 4 PoE Voltage	1 word	16 bits	HEX	0x1803	36148	
	Port 5 PoE Voltage	1 word	16 bits	HEX	0x1804	36149	
	Port 6 PoE Voltage	1 word	16 bits	HEX	0x1805	36150	
	Port 7 PoE Voltage	1 word	16 bits	HEX	0x1806	36151	
	Port 8 PoE Voltage	1 word	16 bits	HEX	0x1807	36152	
	Port 9 PoE Voltage	1 word	16 bits	HEX	0x1808	36153	
	Port 10 PoE Voltage	1 word	16 bits	HEX	0x1809	36154	
	Port 11 PoE Voltage	1 word	16 bits	HEX	0x180A	36155	
	Port 12 PoE Voltage	1 word	16 bits	HEX	0x180B	36156	
	Port 13 PoE Voltage	1 word	16 bits	HEX	0x180C	36157	
	Port 14 PoE Voltage	1 word	16 bits	HEX	0x180D	36158	
	Port 15 PoE Voltage	1 word	16 bits	HEX	0x180E	36159	
	Port 16 PoE Voltage	1 word	16 bits	HEX	0x180F	36160	
Port 17 PoE Voltage	1 word	16 bits	HEX	0x1810	36161		

Table 4-1. Modbus/TCP Mapping Table (Continued)

Catalog	Name	Data Type		Inter-pretation	Address Offset (Hex)	Address 3X	Description
Port Info	Port 18 PoE Voltage	1 word	16 bits	HEX	0x1811	36162	
	Port 19 PoE Voltage	1 word	16 bits	HEX	0x1812	36163	
	Port 20 PoE Voltage	1 word	16 bits	HEX	0x1813	36164	
	Port 21 PoE Voltage	1 word	16 bits	HEX	0x1814	36165	
	Port 22 PoE Voltage	1 word	16 bits	HEX	0x1815	36166	
	Port 23 PoE Voltage	1 word	16 bits	HEX	0x1816	36167	
	Port 24 PoE Voltage	1 word	16 bits	HEX	0x1817	36168	
	Port 25 PoE Voltage	1 word	16 bits	HEX	0x1818	36169	
	Port 26 PoE Voltage	1 word	16 bits	HEX	0x1819	36170	
	Port 27 PoE Voltage	1 word	16 bits	HEX	0x181A	36171	
	Port 28 PoE Voltage	1 word	16 bits	HEX	0x181B	36172	
	Port 29 PoE Voltage	1 word	16 bits	HEX	0x181C	36173	
	Port 30 PoE Voltage	1 word	16 bits	HEX	0x181D	36174	
	Port 31 PoE Voltage	1 word	16 bits	HEX	0x181E	36175	
	Port 32 PoE Voltage	1 word	16 bits	HEX	0x181F	36176	
	PoE Current	1 word	16 bits	HEX	0x1820 ~ 0x183F	36177 ~ 36208	PoE Current (mA) Ex: poe current = 13 Received MODBUS response: 0x000D
	Port 1 PoE Current	1 word	16 bits	HEX	0x1820	36177	
	Port 2 PoE Current	1 word	16 bits	HEX	0x1821	36178	
Port 3 PoE Current	1 word	16 bits	HEX	0x1822	36179		

Table 4-1. Modbus/TCP Mapping Table (Continued)

Catalog	Name	Data Type		Inter-pretation	Address Offset (Hex)	Address 3X	Description
Port Info	Port 4 PoE Current	1 word	16 bits	HEX	0x1823	36180	
	Port 5 PoE Current	1 word	16 bits	HEX	0x1824	36181	
	Port 6 PoE Current	1 word	16 bits	HEX	0x1825	36182	
	Port 7 PoE Current	1 word	16 bits	HEX	0x1826	36183	
	Port 8 PoE Current	1 word	16 bits	HEX	0x1827	36184	
	Port 9 PoE Current	1 word	16 bits	HEX	0x1828	36185	
	Port 10 PoE Current	1 word	16 bits	HEX	0x1829	36186	
	Port 11 PoE Current	1 word	16 bits	HEX	0x182A	36187	
	Port 12 PoE Current	1 word	16 bits	HEX	0x182B	36188	
	Port 13 PoE Current	1 word	16 bits	HEX	0x182C	36189	
	Port 14 PoE Current	1 word	16 bits	HEX	0x182D	36190	
	Port 15 PoE Current	1 word	16 bits	HEX	0x182E	36191	
	Port 16 PoE Current	1 word	16 bits	HEX	0x182F	36192	
	Port 17 PoE Current	1 word	16 bits	HEX	0x1830	36193	
	Port 18 PoE Current	1 word	16 bits	HEX	0x1831	36194	
	Port 19 PoE Current	1 word	16 bits	HEX	0x1832	36195	
	Port 20 PoE Current	1 word	16 bits	HEX	0x1833	36196	
	Port 21 PoE Current	1 word	16 bits	HEX	0x1834	36197	
	Port 22 PoE Current	1 word	16 bits	HEX	0x1835	36198	
	Port 23 PoE Current	1 word	16 bits	HEX	0x1836	36199	

Table 4-1. Modbus/TCP Mapping Table (Continued)

Catalog	Name	Data Type		Interpretation	Address Offset (Hex)	Address 3X	Description
Port Info	Port 24 PoE Current	1 word	16 bits	HEX	0x1837	36200	
	Port 25 PoE Current	1 word	16 bits	HEX	0x1838	36201	
	Port 26 PoE Current	1 word	16 bits	HEX	0x1839	36202	
	Port 27 PoE Current	1 word	16 bits	HEX	0x183A	36203	
	Port 28 PoE Current	1 word	16 bits	HEX	0x183B	36204	
	Port 29 PoE Current	1 word	16 bits	HEX	0x183C	36205	
	Port 30 PoE Current	1 word	16 bits	HEX	0x183D	36206	
	Port 31 PoE Current	1 word	16 bits	HEX	0x183E	36207	
	Port 32 PoE Current	1 word	16 bits	HEX	0x183F	36208	
	PoE Power	1 word	16 bits	HEX	0x1840 ~ 0x185F	36209 ~ 36240	PoE Power (W) Ex: poe power = 10 Received MODBUS response: 0x000A
	Port 1 PoE Power	1 word	16 bits	HEX	0x1840	36209	
	Port 2 PoE Power	1 word	16 bits	HEX	0x1841	36210	
	Port 3 PoE Power	1 word	16 bits	HEX	0x1842	36211	
	Port 4 PoE Power	1 word	16 bits	HEX	0x1843	36212	
	Port 5 PoE Power	1 word	16 bits	HEX	0x1844	36213	
	Port 6 PoE Power	1 word	16 bits	HEX	0x1845	36214	
	Port 7 PoE Power	1 word	16 bits	HEX	0x1846	36215	
	Port 8 PoE Power	1 word	16 bits	HEX	0x1847	36216	
Port 9 PoE Power	1 word	16 bits	HEX	0x1848	36217		

Table 4-1. Modbus/TCP Mapping Table (Continued)

Catalog	Name	Data Type		Inter-pretation	Address Offset (Hex)	Address 3X	Description
Port Info	Port 10 PoE Power	1 word	16 bits	HEX	0x1849	36218	
	Port 11 PoE Power	1 word	16 bits	HEX	0x184A	36219	
	Port 12 PoE Power	1 word	16 bits	HEX	0x184B	36220	
	Port 13 PoE Power	1 word	16 bits	HEX	0x184C	36221	
	Port 14 PoE Power	1 word	16 bits	HEX	0x184D	36222	
	Port 15 PoE Power	1 word	16 bits	HEX	0x184E	36223	
	Port 16 PoE Power	1 word	16 bits	HEX	0x184F	36224	
	Port 17 PoE Power	1 word	16 bits	HEX	0x1850	36225	
	Port 18 PoE Power	1 word	16 bits	HEX	0x1851	36226	
	Port 19 PoE Power	1 word	16 bits	HEX	0x1852	36227	
	Port 20 PoE Power	1 word	16 bits	HEX	0x1853	36228	
	Port 21 PoE Power	1 word	16 bits	HEX	0x1854	36229	
	Port 22 PoE Power	1 word	16 bits	HEX	0x1855	36230	
	Port 23 PoE Power	1 word	16 bits	HEX	0x1856	36231	
	Port 24 PoE Power	1 word	16 bits	HEX	0x1857	36232	
	Port 25 PoE Power	1 word	16 bits	HEX	0x1858	36233	
	Port 26 PoE Power	1 word	16 bits	HEX	0x1859	36234	
	Port 27 PoE Power	1 word	16 bits	HEX	0x185A	36235	
	Port 28 PoE Power	1 word	16 bits	HEX	0x185B	36236	
	Port 29 PoE Power	1 word	16 bits	HEX	0x185C	36237	

Table 4-1. Modbus/TCP Mapping Table (Continued)

Catalog	Name	Data Type		Interpretation	Address Offset (Hex)	Address 3X	Description
Port Info	Port 30 PoE Power	1 word	16 bits	HEX	0x185D	36238	
	Port 31 PoE Power	1 word	16 bits	HEX	0x185E	36239	
	Port 32 PoE Power	1 word	16 bits	HEX	0x185F	36240	
	PoE Temperature	1 word	16 bits	HEX	0x1860 ~ 0x187F	36241 ~ 36272	PoE Temperature (C) Ex: poe temperature = 32 Received MODBUS response: 0x0020
	Port 1 PoE Temperature	1 word	16 bits	HEX	0x1860	36241	
	Port 2 PoE Temperature	1 word	16 bits	HEX	0x1861	36242	
	Port 3 PoE Temperature	1 word	16 bits	HEX	0x1862	36243	
	Port 4 PoE Temperature	1 word	16 bits	HEX	0x1863	36244	
	Port 5 PoE Temperature	1 word	16 bits	HEX	0x1864	36245	
	Port 6 PoE Temperature	1 word	16 bits	HEX	0x1865	36246	
	Port 7 PoE Temperature	1 word	16 bits	HEX	0x1866	36247	
	Port 8 PoE Temperature	1 word	16 bits	HEX	0x1867	36248	
	Port 9 PoE Temperature	1 word	16 bits	HEX	0x1868	36249	
	Port 10 PoE Temperature	1 word	16 bits	HEX	0x1869	36250	
	Port 11 PoE Temperature	1 word	16 bits	HEX	0x186A	36251	
	Port 12 PoE Temperature	1 word	16 bits	HEX	0x186B	36252	
	Port 13 PoE Temperature	1 word	16 bits	HEX	0x186C	36253	
	Port 14 PoE Temperature	1 word	16 bits	HEX	0x186D	36254	
Port 15 PoE Temperature	1 word	16 bits	HEX	0x186E	36255		

Table 4-1. Modbus/TCP Mapping Table (Continued)

Catalog	Name	Data Type		Inter-pretation	Address Offset (Hex)	Address 3X	Description
Port Info	Port 16 PoE Temperature	1 word	16 bits	HEX	0x186F	36256	
	Port 17 PoE Temperature	1 word	16 bits	HEX	0x1870	36257	
	Port 18 PoE Temperature	1 word	16 bits	HEX	0x1871	36258	
	Port 19 PoE Temperature	1 word	16 bits	HEX	0x1872	36259	
	Port 20 PoE Temperature	1 word	16 bits	HEX	0x1873	36260	
	Port 21 PoE Temperature	1 word	16 bits	HEX	0x1874	36261	
	Port 22 PoE Temperature	1 word	16 bits	HEX	0x1875	36262	
	Port 23 PoE Temperature	1 word	16 bits	HEX	0x1876	36263	
	Port 24 PoE Temperature	1 word	16 bits	HEX	0x1877	36264	
	Port 25 PoE Temperature	1 word	16 bits	HEX	0x1878	36265	
	Port 26 PoE Temperature	1 word	16 bits	HEX	0x1879	36266	
	Port 27 PoE Temperature	1 word	16 bits	HEX	0x187A	36267	
	Port 28 PoE Temperature	1 word	16 bits	HEX	0x187B	36268	
	Port 29 PoE Temperature	1 word	16 bits	HEX	0x187C	36269	
	Port 30 PoE Temperature	1 word	16 bits	HEX	0x187D	36270	
	Port 31 PoE Temperature	1 word	16 bits	HEX	0x187E	36271	
	Port 32 PoE Temperature	1 word	16 bits	HEX	0x187F	36272	

Table 4-1. Modbus/TCP Mapping Table (Continued)

Catalog	Name	Data Type		Interpretation	Address Offset (Hex)	Address 3X	Description
Packet Info	Tx Packets Counter	4 words	64 bits	HEX	0x2000 ~ 0x207C	38193 ~ 38317	Tx Packets Ex: port 1 Tx Packet Amount = 11223344 Received MODBUS response: 0xAB4130 Word 0 = 0x0000 Word 1 = 0x0000 Word 2 = 0x00AB Word 3 = 0x4130
	Port 1 Tx Packets	4 words	64 bits	HEX	0x2000	38193	
	Port 2 Tx Packets	4 words	64 bits	HEX	0x2004	38197	
	Port 3 Tx Packets	4 words	64 bits	HEX	0x2008	38201	
	Port 4 Tx Packets	4 words	64 bits	HEX	0x200C	38205	
	Port 5 Tx Packets	4 words	64 bits	HEX	0x2010	38209	
	Port 6 Tx Packets	4 words	64 bits	HEX	0x2014	38213	
	Port 7 Tx Packets	4 words	64 bits	HEX	0x2018	38217	
	Port 8 Tx Packets	4 words	64 bits	HEX	0x201C	38221	
	Port 9 Tx Packets	4 words	64 bits	HEX	0x2020	38225	
	Port 10 Tx Packets	4 words	64 bits	HEX	0x2024	38229	
	Port 11 Tx Packets	4 words	64 bits	HEX	0x2028	38233	
	Port 12 Tx Packets	4 words	64 bits	HEX	0x202C	38237	
	Port 13 Tx Packets	4 words	64 bits	HEX	0x2030	38241	
	Port 14 Tx Packets	4 words	64 bits	HEX	0x2034	38245	
	Port 15 Tx Packets	4 words	64 bits	HEX	0x2038	38249	

Table 4-1. Modbus/TCP Mapping Table (Continued)

Catelog	Name	Data Type		Inter-pretation	Address Offset (Hex)	Address 3X	Description
Packet Info	Port 16 Tx Packets	4 words	64 bits	HEX	0x203C	38253	
	Port 17 Tx Packets	4 words	64 bits	HEX	0x2040	38257	
	Port 18 Tx Packets	4 words	64 bits	HEX	0x2044	38261	
	Port 19 Tx Packets	4 words	64 bits	HEX	0x2048	38265	
	Port 20 Tx Packets	4 words	64 bits	HEX	0x204C	38269	
	Port 21 Tx Packets	4 words	64 bits	HEX	0x2050	38273	
	Port 22 Tx Packets	4 words	64 bits	HEX	0x2054	38277	
	Port 23 Tx Packets	4 words	64 bits	HEX	0x2058	38281	
	Port 24 Tx Packets	4 words	64 bits	HEX	0x205C	38285	
	Port 25 Tx Packets	4 words	64 bits	HEX	0x2060	38289	
	Port 26 Tx Packets	4 words	64 bits	HEX	0x2064	38293	
	Port 27 Tx Packets	4 words	64 bits	HEX	0x2068	38297	
	Port 28 Tx Packets	4 words	64 bits	HEX	0x206C	38301	
	Port 29 Tx Packets	4 words	64 bits	HEX	0x2070	38305	
	Port 30 Tx Packets	4 words	64 bits	HEX	0x2074	38309	
	Port 31 Tx Packets	4 words	64 bits	HEX	0x2078	38313	
Port 32 Tx Packets	4 words	64 bits	HEX	0x207C	38317		

Table 4-1. Modbus/TCP Mapping Table (Continued)

Catalog	Name	Data Type		Interpretation	Address Offset (Hex)	Address 3X	Description
Packet Info	Rx Packets Counter	4 words	64 bits	HEX	0x2100 ~0x217C	38449 ~ 38573	Rx Packets Ex: port 1 Rx Packet Amount = 11223344 Received MODBUS response: 0xAB4130 Word 0 = 0x0000 Word 1 = 0x0000 Word 2 = 0x00AB Word 3 = 0x4130
	Port 1 Rx Packets	4 words	64 bits	HEX	0x2100	38449	
	Port 2 Rx Packets	4 words	64 bits	HEX	0x2104	38453	
	Port 3 Rx Packets	4 words	64 bits	HEX	0x2108	38457	
	Port 4 Rx Packets	4 words	64 bits	HEX	0x210C	38461	
	Port 5 Rx Packets	4 words	64 bits	HEX	0x2110	38465	
	Port 6 Rx Packets	4 words	64 bits	HEX	0x2114	38469	
	Port 7 Rx Packets	4 words	64 bits	HEX	0x2118	38473	
	Port 8 Rx Packets	4 words	64 bits	HEX	0x211C	38477	
	Port 9 Rx Packets	4 words	64 bits	HEX	0x2120	38481	
	Port 10 Rx Packets	4 words	64 bits	HEX	0x2124	38485	
	Port 11 Rx Packets	4 words	64 bits	HEX	0x2128	38489	
	Port 12 Rx Packets	4 words	64 bits	HEX	0x212C	38493	
	Port 13 Rx Packets	4 words	64 bits	HEX	0x2130	38497	
	Port 14 Rx Packets	4 words	64 bits	HEX	0x2134	38501	
	Port 15 Rx Packets	4 words	64 bits	HEX	0x2138	38505	

Table 4-1. Modbus/TCP Mapping Table (Continued)

Catalog	Name	Data Type		Inter-pretation	Address Offset (Hex)	Address 3X	Description
Packet Info	Port 16 Rx Packets	4 words	64 bits	HEX	0x213C	38509	
	Port 17 Rx Packets	4 words	64 bits	HEX	0x2140	38513	
	Port 18 Rx Packets	4 words	64 bits	HEX	0x2144	38517	
	Port 19 Rx Packets	4 words	64 bits	HEX	0x2148	38521	
	Port 20 Rx Packets	4 words	64 bits	HEX	0x214C	38525	
	Port 21 Rx Packets	4 words	64 bits	HEX	0x2150	38529	
	Port 22 Rx Packets	4 words	64 bits	HEX	0x2154	38533	
	Port 23 Rx Packets	4 words	64 bits	HEX	0x2158	38537	
	Port 24 Rx Packets	4 words	64 bits	HEX	0x215C	38541	
	Port 25 Rx Packets	4 words	64 bits	HEX	0x2160	38545	
	Port 26 Rx Packets	4 words	64 bits	HEX	0x2164	38549	
	Port 27 Rx Packets	4 words	64 bits	HEX	0x2168	38553	
	Port 28 Rx Packets	4 words	64 bits	HEX	0x216C	38557	
	Port 29 Rx Packets	4 words	64 bits	HEX	0x2170	38561	
	Port 30 Rx Packets	4 words	64 bits	HEX	0x2174	38565	
	Port 31 Rx Packets	4 words	64 bits	HEX	0x2178	38569	
	Port 32 Rx Packets	4 words	64 bits	HEX	0x217C	38573	

Table 4-1. Modbus/TCP Mapping Table (Continued)

Catelog	Name	Data Type		Inter-pretation	Address Offset (Hex)	Address 3X	Description
Packet Info	Tx Error Packets Counter	2 words	32 bits	HEX	0x2200 ~ 0x223E	38705 ~ 38767	Tx Error Packets Ex: port 1 Tx Packet Amount = 11223344 Received MODBUS response: 0xAB4130 Word 0 = 0x00AB Word 1 = 0x4130
	Port 1 Tx Error Packets	2 words	32 bits	HEX	0x2200	38705	
	Port 2 Tx Error Packets	2 words	32 bits	HEX	0x2202	38707	
	Port 3 Tx Error Packets	2 words	32 bits	HEX	0x2204	38709	
	Port 4 Tx Error Packets	2 words	32 bits	HEX	0x2206	38711	
	Port 5 Tx Error Packets	2 words	32 bits	HEX	0x2208	38713	
	Port 6 Tx Error Packets	2 words	32 bits	HEX	0x220A	38715	
	Port 7 Tx Error Packets	2 words	32 bits	HEX	0x220C	38717	
	Port 8 Tx Error Packets	2 words	32 bits	HEX	0x220E	38719	
	Port 9 Tx Error Packets	2 words	32 bits	HEX	0x2210	38721	
	Port 10 Tx Error Packets	2 words	32 bits	HEX	0x2212	38723	
	Port 11 Tx Error Packets	2 words	32 bits	HEX	0x2214	38725	
	Port 12 Tx Error Packets	2 words	32 bits	HEX	0x2216	38727	

Table 4-1. Modbus/TCP Mapping Table (Continued)

Catalog	Name	Data Type		Inter-pretation	Address Offset (Hex)	Address 3X	Description
Packet Info	Port 13 Tx Error Packets	2 words	32 bits	HEX	0x2218	38729	
	Port 14 Tx Error Packets	2 words	32 bits	HEX	0x221A	38731	
	Port 15 Tx Error Packets	2 words	32 bits	HEX	0x221C	38733	
	Port 16 Tx Error Packets	2 words	32 bits	HEX	0x221E	38735	
	Port 17 Tx Error Packets	2 words	32 bits	HEX	0x2220	38737	
	Port 18 Tx Error Packets	2 words	32 bits	HEX	0x2222	38739	
	Port 19 Tx Error Packets	2 words	32 bits	HEX	0x2224	38741	
	Port 20 Tx Error Packets	2 words	32 bits	HEX	0x2226	38743	
	Port 21 Tx Error Packets	2 words	32 bits	HEX	0x2228	38745	
	Port 22 Tx Error Packets	2 words	32 bits	HEX	0x222A	38747	
	Port 23 Tx Error Packets	2 words	32 bits	HEX	0x222C	38749	
	Port 24 Tx Error Packets	2 words	32 bits	HEX	0x222E	38751	
	Port 25 Tx Error Packets	2 words	32 bits	HEX	0x2230	38753	
	Port 26 Tx Error Packets	2 words	32 bits	HEX	0x2232	38755	

Table 4-1. Modbus/TCP Mapping Table (Continued)

Catalog	Name	Data Type		Inter-pretation	Address Offset (Hex)	Address 3X	Description
Packet Info	Port 27 Tx Error Packets	2 words	32 bits	HEX	0x2234	38757	
	Port 28 Tx Error Packets	2 words	32 bits	HEX	0x2236	38759	
	Port 29 Tx Error Packets	2 words	32 bits	HEX	0x2238	38761	
	Port 30 Tx Error Packets	2 words	32 bits	HEX	0x223A	38763	
	Port 31 Tx Error Packets	2 words	32 bits	HEX	0x223C	38765	
	Port 32 Tx Error Packets	2 words	32 bits	HEX	0x223E	38767	
	Rx Error Packets Counter	2 words	32 bits	HEX	0x2300 ~ 0x233E	38961 ~ 39023	Rx Error Packets Ex: port 1 Rx Packet Amount = 11223344 Received MODBUS response: 0xAB4130 Word 0 = 0x00AB Word 1 = 0x4130
	Port 1 Rx Error Packets	2 words	32 bits	HEX	0x2300	38961	
	Port 2 Rx Error Packets	2 words	32 bits	HEX	0x2302	38963	
	Port 3 Rx Error Packets	2 words	32 bits	HEX	0x2304	38965	
	Port 4 Rx Error Packets	2 words	32 bits	HEX	0x2306	38967	
	Port 5 Rx Error Packets	2 words	32 bits	HEX	0x2308	38969	
	Port 6 Rx Error Packets	2 words	32 bits	HEX	0x230A	38971	

Table 4-1. Modbus/TCP Mapping Table (Continued)

Catalog	Name	Data Type		Inter-pretation	Address Offset (Hex)	Address 3X	Description
Packet Info	Port 7 Rx Error Packets	2 words	32 bits	HEX	0x230C	38973	
	Port 8 Rx Error Packets	2 words	32 bits	HEX	0x230E	38975	
	Port 9 Rx Error Packets	2 words	32 bits	HEX	0x2310	38977	
	Port 10 Rx Error Packets	2 words	32 bits	HEX	0x2312	38979	
	Port 11 Rx Error Packets	2 words	32 bits	HEX	0x2314	38981	
	Port 12 Rx Error Packets	2 words	32 bits	HEX	0x2316	38983	
	Port 13 Rx Error Packets	2 words	32 bits	HEX	0x2318	38985	
	Port 14 Rx Error Packets	2 words	32 bits	HEX	0x231A	38987	
	Port 15 Rx Error Packets	2 words	32 bits	HEX	0x231C	38989	
	Port 16 Rx Error Packets	2 words	32 bits	HEX	0x231E	38991	
	Port 17 Rx Error Packets	2 words	32 bits	HEX	0x2320	38993	
	Port 18 Rx Error Packets	2 words	32 bits	HEX	0x2322	38995	
	Port 19 Rx Error Packets	2 words	32 bits	HEX	0x2324	38997	
	Port 20 Rx Error Packets	2 words	32 bits	HEX	0x2326	38999	

Table 4-1. Modbus/TCP Mapping Table (Continued)

Catalog	Name	Data Type		Interpretation	Address Offset (Hex)	Address 3X	Description
Packet Info	Port 21 Rx Error Packets	2 words	32 bits	HEX	0x2328	39001	
	Port 22 Rx Error Packets	2 words	32 bits	HEX	0x232A	39003	
	Port 23 Rx Error Packets	2 words	32 bits	HEX	0x232C	39005	
	Port 24 Rx Error Packets	2 words	32 bits	HEX	0x232E	39007	
	Port 25 Rx Error Packets	2 words	32 bits	HEX	0x2330	39009	
	Port 26 Rx Error Packets	2 words	32 bits	HEX	0x2332	39011	
	Port 27 Rx Error Packets	2 words	32 bits	HEX	0x2334	39013	
	Port 28 Rx Error Packets	2 words	32 bits	HEX	0x2336	39015	
	Port 29 Rx Error Packets	2 words	32 bits	HEX	0x2338	39017	
	Port 30 Rx Error Packets	2 words	32 bits	HEX	0x233A	39019	
	Port 31 Rx Error Packets	2 words	32 bits	HEX	0x233C	39021	
	Port 32 Rx Error Packets	2 words	32 bits	HEX	0x233E	39023	