

# AVX Surface Mount Ceramic Capacitor Products

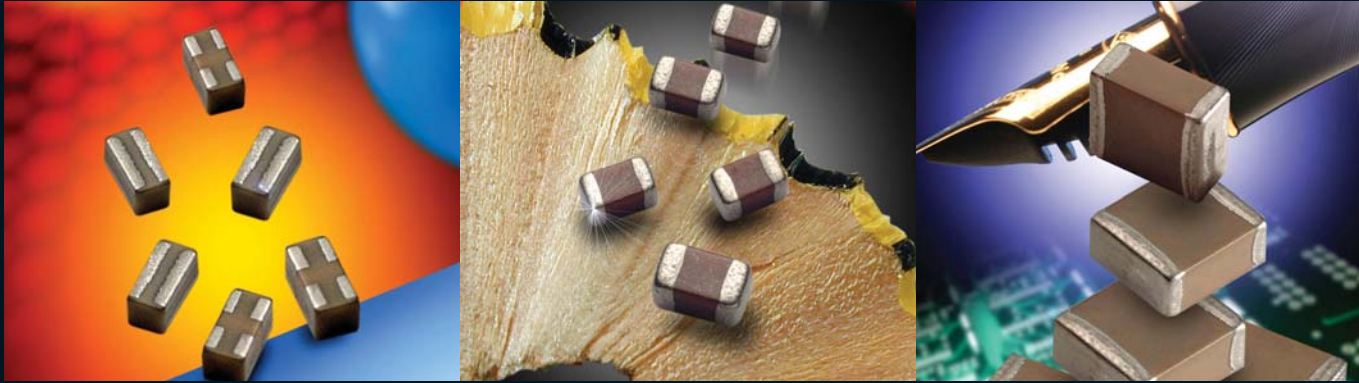

Version 12.7

[www.avx.com](http://www.avx.com)

**AVX**  
A KYOCERA GROUP COMPANY



# Ceramic Chip Capacitors

## Table of Contents

<b>How to Order - AVX Part Number Explanation</b> .....	<b>2-3</b>
<b>C0G (NP0) Dielectric</b>	
General Specifications .....	<b>4</b>
Specifications and Test Methods .....	<b>5</b>
Capacitance Range .....	<b>6-7</b>
<b>U Dielectric</b>	
RF/Microwave C0G (NP0) Capacitors (RoHS) General Information and Capacitance Range .....	<b>8-10</b>
RF/Microwave C0G (NP0) Capacitors (Sn/Pb) General Information and Capacitance Range .....	<b>11-12</b>
Designer Kits .....	<b>13</b>
<b>X8R/X8L Dielectric</b>	
General Specifications .....	<b>14-15</b>
Specifications and Test Methods .....	<b>16</b>
<b>X7R Dielectric</b>	
General Specifications .....	<b>17</b>
Specifications and Test Methods .....	<b>18</b>
Capacitance Range .....	<b>19-20</b>
<b>X7S Dielectric</b>	
General Specifications .....	<b>21</b>
Specifications and Test Methods .....	<b>22</b>
Capacitance Range .....	<b>23</b>
<b>X5R Dielectric</b>	
General Specifications .....	<b>24</b>
Specifications and Test Methods .....	<b>25</b>
Capacitance Range .....	<b>26</b>
<b>Y5V Dielectric</b>	
General Specifications .....	<b>27</b>
Specifications and Test Methods .....	<b>28</b>
Capacitance Range .....	<b>29</b>
<b>MLCC Gold Termination (AU Series)</b>	
General Specifications .....	<b>30</b>
Capacitance Range .....	<b>31-36</b>
<b>MLCC Tin/Lead Termination (LD Series)</b>	
General Specifications .....	<b>37</b>
Capacitance Range .....	<b>38-43</b>
<b>MLCC Low Profile</b>	
General Specifications / Capacitance Range .....	<b>44</b>
<b>UltraThin Ceramic Capacitors</b>	
General Specifications .....	<b>45</b>
<b>Automotive MLCC</b>	
General Specifications .....	<b>46-47</b>
Capacitance Range .....	<b>48-50</b>
<b>APS for COTS+ Applications</b>	
General Specifications .....	<b>51</b>
Capacitance Range .....	<b>52-53</b>
<b>MLCC with FLEXITERM®</b>	
General Description .....	<b>54</b>
Specifications and Test Methods .....	<b>55-56</b>
Capacitance Range .....	<b>57-58</b>
<b>FLEXISAFE MLC Chips</b>	
General Specifications and Capacitance Range .....	<b>59</b>
<b>Capacitor Array</b>	
Capacitor Array (IPC) .....	<b>60-63</b>
Automotive Capacitor Array (IPC) .....	<b>64</b>
Part and Pad Layout Dimensions .....	<b>65</b>
<b>Low Inductance Capacitors</b>	
Introduction .....	<b>66-67</b>
LICC (Low Inductance Chip Capacitors) .....	<b>68-71</b>
IDC (InterDigitated Capacitors) .....	<b>72-75</b>
LGA Low Inductance Capacitors .....	<b>76-78</b>
LICA (Low Inductance Decoupling Capacitor Arrays) .....	<b>79-80</b>
<b>High Voltage MLC Chips</b>	
600V to 5000V Applications .....	<b>81-82</b>
Tin/Lead Termination "B" - 600V to 5000V Applications .....	<b>83-84</b>
FLEXITERM® - 600V to 3000V Applications .....	<b>85-86</b>
<b>MIL-PRF-55681/Chips</b>	
CDR01 thru CDR06 .....	<b>87-88</b>
CDR31 thru CDR35 .....	<b>89-92</b>
<b>Packaging of Chip Components</b> .....	<b>93</b>
<b>Embossed Carrier Configuration - 8 &amp; 12mm Tape</b> .....	<b>94</b>
<b>Paper Carrier Configuration - 8 &amp; 12mm Tape</b> .....	<b>95</b>
<b>Bulk Case Packaging</b> .....	<b>96</b>
<b>Basic Capacitor Formulas</b> .....	<b>97</b>
<b>General Description</b> .....	<b>98-102</b>
<b>Surface Mounting Guide</b> .....	<b>103-107</b>



# How to Order

## Part Number Explanation



### Commercial Surface Mount Chips

**EXAMPLE: 08055A101JAT2A**

0805	5	A	101	J*	A	T	2	A**
<b>Size</b> (L" x W")	<b>Voltage</b>	<b>Dielectric</b>	<b>Capacitance</b>	<b>Tolerance</b>	<b>Failure Rate</b>	<b>Terminations</b>	<b>Packaging Available</b>	<b>Special Code</b>
0101*	4 = 4V	A = NP0(C0G)	2 Sig. Fig + No. of Zeros	B = ±.10 pF	A = N/A	T = Plated Ni and Sn	2 = 7" Reel	A = Std
0201	6 = 6.3V	C = X7R	Examples:	C = ±.25 pF	4 = Automotive	7 = Gold Plated	4 = 13" Reel	K = 30K (0603 2mm pitch)
0402	Z = 10V	D = X5R	100 = 10 pF	D = ±.50 pF		U = Conductive Epoxy for Hybrid Applications	7 = Bulk Cass.	22K (0805/1206 <0.030" / 0.76mm)
0603	Y = 16V	F = X8R	101 = 100 pF	F = ±1% (≥ 10 pF)		Z = FLEXITERM®	9 = Bulk	H = 18K (0603/0805/1206 <0.037" / 0.94mm)
0805	D = 35V	G = Y5V	102 = 1000 pF	G = ±2% (≥ 10 pF)		X = FLEXITERM® with 5% min lead (X7R & X8R only)	U = 4mm TR (01005)	J = 15K (0805/1206 <0.050" / 1.27mm)
1206	5 = 50V	U = U Series	223 = 22000 pF	J = ±5%		<b>Contact Factory For Multiples</b>		1 = 12K (0805/1206 <0.055" / 1.4mm)
1210	1 = 100V	W = X6S	224 = 220000 pF	K = ±10%		<b>Contact Factory For 1 = Pd/Ag Term</b>		**Non std options upon approval from the factory
1812	2 = 200V	Z = X7S	105 = 1µF	M = ±20%				
1825	7 = 500V		106 = 10µF	Z = +80%, -20%				
2220			107 = 100µF	P = +100%, -0%				
2225			For values below 10 pF, use "R" in place of decimal point, e.g., 9.1 pF = 9R1.					

**Contact Factory for Special Voltages**

F = 63V      9 = 300V  
 \* = 75V     X = 350V  
 E = 150V    8 = 400V  
 V = 250V

\*EIA 01005

\* B, C & D tolerance for ≤10 pF values.

Standard Tape and Reel material (Paper/Embossed) depends upon chip size and thickness.

See individual part tables for tape material type for each capacitance value.

NOTE: Contact factory for availability of Termination and Tolerance Options for Specific Part Numbers. For Tin/Lead Terminations, please refer to LD Series

### High Voltage MLC Chips

**EXAMPLE: 1808AA271KA11A**

1808	A	A	271	K	A	T	1	A
<b>AVX Style</b>	<b>Voltage</b>	<b>Temperature Coefficient</b>	<b>Capacitance Code</b>	<b>Capacitance Tolerance</b>	<b>Failure Rate</b>	<b>Termination</b>	<b>Packaging/Marking</b>	<b>Special Code</b>
0805	C = 600V/630V	A = C0G	(2 significant digits + no. of zeros)	C0G: J = ±5%	A=Not Applicable	1 = Pd/Ag	1 = 7" Reel	A = Standard
1206	A = 1000V	C = X7R	Examples:	K = ±10%		T = Plated Ni and Sn	3 = 13" Reel	
1210	S = 1500V		10 pF = 100	M = ±20%		B = 5% Min Pb	9 = Bulk	
1808	G = 2000V		100 pF = 101	X7R: K = ±10%		Z = FLEXITERM®		
1812	W = 2500V		1,000 pF = 102	M = ±20%		X = FLEXITERM® with 5% min lead (X7R only)		
1825	H = 3000V		22,000 pF = 223	Z = +80%, -20%				
2220	J = 4000V		220,000 pF = 224					
2225	K = 5000V		1 µF = 105					
3640								

NOTE: Contact factory for availability of Termination and Tolerance Options for Specific Part Numbers. For Tin/Lead Terminations, please refer to LD Series

**Not RoHS Compliant**



For RoHS compliant products, please select correct termination style.

# How to Order

## Part Number Explanation

### Capacitor Array

#### EXAMPLE: W2A43C103MAT2A

W	2	A	4	3	C	103	M	A	T	2A
<b>Style</b> W = RoHS L = SnPb	<b>Case Size</b> 1 = 0405 2 = 0508 3 = 0612	<b>Array</b>	<b>Number of Caps</b>	<b>Voltage</b> Z = 10V Y = 16V 3 = 25V 5 = 50V 1 = 100V	<b>Dielectric</b> A = NP0 C = X7R D = X5R	<b>Capacitance Code (In pF)</b> 2 Sig Digits + Number of Zeros	<b>Capacitance Tolerance</b> J = ±5% K = ±10% M = ±20%	<b>Failure Rate</b> A = Commercial 4 = Automotive	<b>Termination Code</b> T = Plated Ni and Sn Z = FLEXITERM® B = 5% min lead X = FLEXITERM® with 5% min lead	<b>Packaging &amp; Quantity Code</b> 2A = 7" Reel (4000) 4A = 13" Reel (10000) 2F = 7" Reel (1000)

NOTE: Contact factory for availability of Termination and Tolerance Options for Specific Part Numbers.

### Low Inductance Capacitors (LICC)

#### EXAMPLE: 0612ZD105MAT2A

0612	Z	D	105	M	A	T	2	A
<b>Size</b> 0306 0508 0612 LD16 LD17 LD18	<b>Voltage</b> 6 = 6.3V Z = 10V Y = 16V 3 = 25V 5 = 50V	<b>Dielectric</b> C = X7R D = X5R	<b>Capacitance Code (In pF)</b> 2 Sig. Digits + Number of Zeros	<b>Capacitance Tolerance</b> K = ±10% M = ±20%	<b>Failure Rate</b> A = N/A	<b>Terminations</b> T = Plated Ni and Sn B = 5% min lead	<b>Packaging Available</b> 2 = 7" Reel 4 = 13" Reel	<b>Thickness</b> See Page 71 for Codes

NOTE: Contact factory for availability of Termination and Tolerance Options for Specific Part Numbers.

### Interdigitated Capacitors (IDC)

#### EXAMPLE: W3L16D225MAT3A

W	3	L	1	6	D	225	M	A	T	3	A
<b>Style</b> W = RoHS L = SnPb	<b>Case Size</b> 2 = 0508 3 = 0612	<b>Low Inductance</b> ESL = 50pH ESL = 60pH	<b>Number of Terminals</b> 1 = 8 Terminals	<b>Voltage</b> 4 = 4V 6 = 6.3V Z = 10V Y = 16V	<b>Dielectric</b> C = X7R D = X5R	<b>Capacitance Code (In pF)</b> 2 Sig. Digits + Number of Zeros	<b>Capacitance Tolerance</b> M = ±20%	<b>Failure Rate</b> A = N/A	<b>Termination</b> T = Plated Ni and Sn B = 5% min Lead	<b>Packaging Available</b> 1=7" Reel 3=13" Reel	<b>Thickness</b> Max. Thickness mm (in.) A=0.95 (0.037) S=0.55 (0.022)

NOTE: Contact factory for availability of Termination and Tolerance Options for Specific Part Numbers.

### Low Inductance Decoupling Capacitor Arrays (LICA)

#### EXAMPLE: LICA3T183M3FC4AA

LICA	3	T	102	M	3	F	C	4	A	A
<b>Style &amp; Size</b> 5V = 9 10V = Z 25V = 3	<b>Voltage</b> 5V = 9 10V = Z 25V = 3	<b>Dielectric</b> D = X5R T = T55T S = High K T55T	<b>Cap/Section (EIA Code)</b> 102 = 1000 pF 103 = 10 nF 104 = 100 nF	<b>Capacitance Tolerance</b> M = ±20% P = GMV	<b>Height Code</b> 6 = 0.500mm 3 = 0.650mm 1 = 0.875mm 5 = 1.100mm 7 = 1.600mm	<b>Termination</b> F = C4 Solder Balls- 97Pb/3Sn H = C4 Solder Balls-Low ESR P = Cr-Cu-Au N = Cr-Ni-Au X = None	<b>Reel Packaging</b> M = 7" Reel R = 13" Reel 6 = 2"x2" Waffle Pack 8 = 2"x2" Black Waffle Pack 7 = 2"x2" Waffle Pack w/ termination facing up A = 2"x2" Black Waffle Pack w/ termination facing up C = 4"x4" Waffle Pack w/ clear lid	<b># of Caps/Part</b> 1 = one 2 = two 4 = four	<b>Inspection Code</b> A = Standard B = Established Reliability Testing	<b>Code Face</b> A = Bar B = No Bar C = Dot, S55S Dielectrics D = Triangle

**Not RoHS Compliant**



For RoHS compliant products, please select correct termination style.

NOTE: Contact factory for availability of Termination and Tolerance Options for Specific Part Numbers.

# COG (NP0) Dielectric



## General Specifications

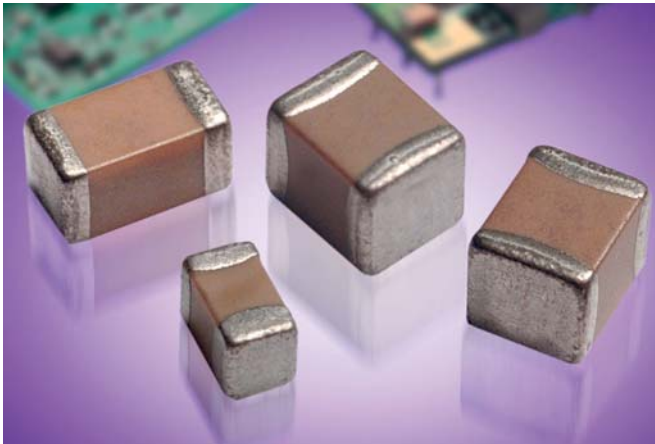

COG (NP0) is the most popular formulation of the “temperature-compensating,” EIA Class I ceramic materials. Modern COG (NP0) formulations contain neodymium, samarium and other rare earth oxides.

COG (NP0) ceramics offer one of the most stable capacitor dielectrics available. Capacitance change with temperature is  $0 \pm 30\text{ppm}/^\circ\text{C}$  which is less than  $\pm 0.3\%$   $\Delta C$  from  $-55^\circ\text{C}$  to  $+125^\circ\text{C}$ . Capacitance drift or hysteresis for COG (NP0) ceramics is negligible at less than  $\pm 0.05\%$  versus up to  $\pm 2\%$  for films. Typical capacitance change with life is less than  $\pm 0.1\%$  for COG (NP0), one-fifth that shown by most other dielectrics. COG (NP0) formulations show no aging characteristics.



### PART NUMBER (see page 2 for complete part number explanation)

**0805**

**Size**  
(L" x W")

**5**

**Voltage**  
6.3V = 6  
10V = Z  
16V = Y  
25V = 3  
50V = 5  
100V = 1  
200V = 2  
500V = 7

**A**

**Dielectric**  
COG (NP0) = A

**101**

**Capacitance Code (In pF)**  
2 Sig. Digits + Number of Zeros

**J**

**Capacitance Tolerance**  
B =  $\pm 10\text{ pF}$  ( $< 10\text{ pF}$ )  
C =  $\pm 25\text{ pF}$  ( $< 10\text{ pF}$ )  
D =  $\pm 50\text{ pF}$  ( $< 10\text{ pF}$ )  
F =  $\pm 1\%$  ( $\geq 10\text{ pF}$ )  
G =  $\pm 2\%$  ( $\geq 10\text{ pF}$ )  
J =  $\pm 5\%$   
K =  $\pm 10\%$

**A**

**Failure Rate**  
A = Not Applicable

**T**

**Terminations**  
T = Plated Ni and Sn  
7 = Gold Plated

**2**

**Packaging**  
2 = 7" Reel  
4 = 13" Reel  
7 = Bulk Cass.  
9 = Bulk  
U = 4mm TR (01005)

**A**

**Special Code**  
A = Std. Product

**Contact Factory For**  
**1 = Pd/Ag Term**

**Contact Factory For**  
**Multiples**

NOTE: Contact factory for availability of Termination and Tolerance Options for Specific Part Numbers. Contact factory for non-specified capacitance values.

**Temperature Coefficient**

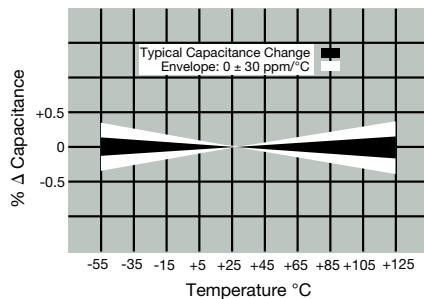

**Δ Capacitance vs. Frequency**

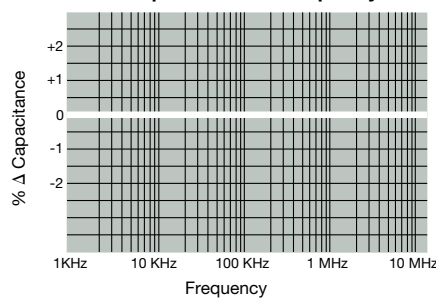

**Insulation Resistance vs Temperature**

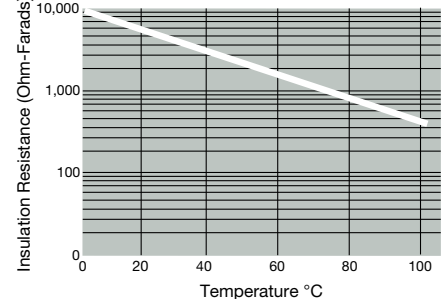

**Variation of Impedance with Cap Value**  
**Impedance vs. Frequency**  
0805 - COG (NP0)  
10 pF vs. 100 pF vs. 1000 pF

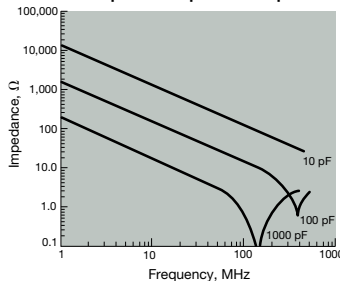

**Variation of Impedance with Chip Size**  
**Impedance vs. Frequency**  
1000 pF - COG (NP0)

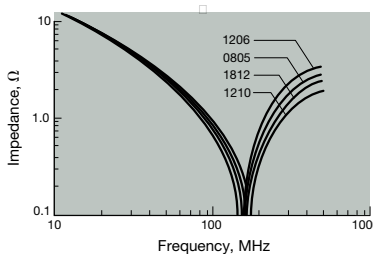

**Variation of Impedance with Ceramic Formulation**  
**Impedance vs. Frequency**  
1000 pF - COG (NP0) vs X7R  
0805

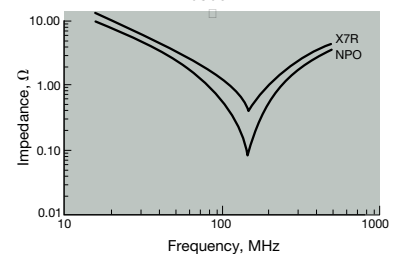

# COG (NP0) Dielectric

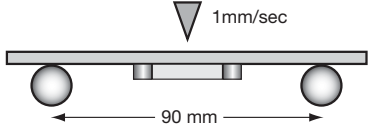

## Specifications and Test Methods

Parameter/Test		NP0 Specification Limits	Measuring Conditions	
<b>Operating Temperature Range</b>		-55°C to +125°C	Temperature Cycle Chamber	
<b>Capacitance</b>		Within specified tolerance	Freq.: 1.0 MHz $\pm$ 10% for cap $\leq$ 1000 pF 1.0 kHz $\pm$ 10% for cap $>$ 1000 pF Voltage: 1.0Vrms $\pm$ .2V	
<b>Q</b>		<30 pF: Q $\geq$ 400+20 x Cap Value $\geq$ 30 pF: Q $\geq$ 1000	Charge device with rated voltage for 60 $\pm$ 5 secs @ room temp/humidity	
<b>Insulation Resistance</b>		100,000M $\Omega$ or 1000M $\Omega$ - $\mu$ F, whichever is less	Charge device with 300% of rated voltage for 1-5 seconds, w/charge and discharge current limited to 50 mA (max) Note: Charge device with 150% of rated voltage for 500V devices.	
<b>Dielectric Strength</b>		No breakdown or visual defects	Deflection: 2mm Test Time: 30 seconds 1mm/sec 	
<b>Resistance to Flexure Stresses</b>	Appearance	No defects		
	Capacitance Variation	$\pm$ 5% or $\pm$ .5 pF, whichever is greater		
	Q	Meets Initial Values (As Above)		
	Insulation Resistance	$\geq$ Initial Value x 0.3		
<b>Solderability</b>		$\geq$ 95% of each terminal should be covered with fresh solder	Dip device in eutectic solder at 230 $\pm$ 5°C for 5.0 $\pm$ 0.5 seconds	
<b>Resistance to Solder Heat</b>	Appearance	No defects, <25% leaching of either end terminal	Dip device in eutectic solder at 260°C for 60 seconds. Store at room temperature for 24 $\pm$ 2 hours before measuring electrical properties.	
	Capacitance Variation	$\leq$ $\pm$ 2.5% or $\pm$ .25 pF, whichever is greater		
	Q	Meets Initial Values (As Above)		
	Insulation Resistance	Meets Initial Values (As Above)		
<b>Thermal Shock</b>	Dielectric Strength	Meets Initial Values (As Above)	Repeat for 5 cycles and measure after 24 hours at room temperature	
	Appearance	No visual defects	Step 1: -55°C $\pm$ 2°	30 $\pm$ 3 minutes
	Capacitance Variation	$\leq$ $\pm$ 2.5% or $\pm$ .25 pF, whichever is greater	Step 2: Room Temp	$\leq$ 3 minutes
	Q	Meets Initial Values (As Above)	Step 3: +125°C $\pm$ 2°	30 $\pm$ 3 minutes
	Insulation Resistance	Meets Initial Values (As Above)	Step 4: Room Temp	$\leq$ 3 minutes
<b>Load Life</b>	Dielectric Strength	Meets Initial Values (As Above)	Charge device with twice rated voltage in test chamber set at 125°C $\pm$ 2°C for 1000 hours (+48, -0).	
	Appearance	No visual defects	Remove from test chamber and stabilize at room temperature for 24 hours before measuring.	
	Capacitance Variation	$\leq$ $\pm$ 3.0% or $\pm$ .3 pF, whichever is greater		
	Q (C=Nominal Cap)	$\geq$ 30 pF: Q $\geq$ 350 $\geq$ 10 pF, <30 pF: Q $\geq$ 275 +5C/2 <10 pF: Q $\geq$ 200 +10C		
	Insulation Resistance	$\geq$ Initial Value x 0.3 (See Above)		
<b>Load Humidity</b>	Dielectric Strength	Meets Initial Values (As Above)	Store in a test chamber set at 85°C $\pm$ 2°C/ 85% $\pm$ 5% relative humidity for 1000 hours (+48, -0) with rated voltage applied.	
	Appearance	No visual defects	Remove from chamber and stabilize at room temperature for 24 $\pm$ 2 hours before measuring.	
	Capacitance Variation	$\leq$ $\pm$ 5.0% or $\pm$ .5 pF, whichever is greater		
	Q	$\geq$ 30 pF: Q $\geq$ 350 $\geq$ 10 pF, <30 pF: Q $\geq$ 275 +5C/2 <10 pF: Q $\geq$ 200 +10C		
<b>Insulation Resistance</b>	Insulation Resistance	$\geq$ Initial Value x 0.3 (See Above)		
	Dielectric Strength	Meets Initial Values (As Above)		

# COG (NP0) Dielectric

## Capacitance Range



### PREFERRED SIZES ARE SHADED

SIZE	0101*			0201			0402			0603				0805					1206																																																																																																																																																																																																																																															
Soldering	Reflow Only			Reflow Only			Reflow/Wave			Reflow/Wave				Reflow/Wave					Reflow/Wave																																																																																																																																																																																																																																															
Packaging	All Paper			All Paper			All Paper			All Paper				Paper/Embossed					Paper/Embossed																																																																																																																																																																																																																																															
(L) Length	mm 0.40 ± 0.02 (0.016 ± 0.0008)			mm 0.60 ± 0.03 (0.024 ± 0.001)			mm 1.00 ± 0.10 (0.040 ± 0.004)			mm 1.60 ± 0.15 (0.063 ± 0.006)				mm 2.01 ± 0.20 (0.079 ± 0.008)					mm 3.20 ± 0.20 (0.126 ± 0.008)																																																																																																																																																																																																																																															
(W) Width	mm 0.20 ± 0.02 (0.008 ± 0.0008)			mm 0.30 ± 0.03 (0.011 ± 0.001)			mm 0.50 ± 0.10 (0.020 ± 0.004)			mm 0.81 ± 0.15 (0.032 ± 0.006)				mm 1.25 ± 0.20 (0.049 ± 0.008)					mm 1.60 ± 0.20 (0.063 ± 0.008)																																																																																																																																																																																																																																															
(t) Terminal	mm 0.10 ± 0.04 (0.004 ± 0.016)			mm 0.15 ± 0.05 (0.006 ± 0.002)			mm 0.25 ± 0.15 (0.010 ± 0.006)			mm 0.35 ± 0.15 (0.014 ± 0.006)				mm 0.50 ± 0.25 (0.020 ± 0.010)					mm 0.50 ± 0.25 (0.020 ± 0.010)																																																																																																																																																																																																																																															
WVDC	16			25 50			16 25 50			16 25 50 100				16 25 50 100 200					16 25 50 100 200 500																																																																																																																																																																																																																																															
Cap (pF)	0.5			1.0			1.2			1.5				1.8					2.2					2.7																																																																																																																																																																																																																																										
3.3	3.9			4.7			5.6			6.8				8.2					10					12					15					18					22					27					33					39					47					56					68					82					100					120					150					180					220					270					330					390					470					560					680					820					1000					1200					1500					1800					2200					2700					3300					3900					4700					5600					6800					8200					0.010					0.012					0.015					0.018					0.022					0.027					0.033					0.039					0.047					0.068					0.082					0.1				
WVDC	16			25 50			16 25 50			16 25 50 100				16 25 50 100 200					16 25 50 100 200					16 25 50 100 200 500																																																																																																																																																																																																																																										
Letter	A B C E G J			K M N P Q X Y Z																																																																																																																																																																																																																																																														
Max. Thickness	0.33 (0.013)			0.22 (0.009)			0.56 (0.022)			0.71 (0.028)			0.90 (0.035)			0.94 (0.037)				1.02 (0.040)				1.27 (0.050)			1.40 (0.055)			1.52 (0.060)			1.78 (0.070)			2.29 (0.090)			2.54 (0.100)			2.79 (0.110)																																																																																																																																																																																																																								

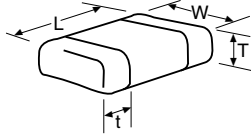

\*EIA 01005



# COG (NP0) Dielectric



## Capacitance Range

PREFERRED SIZES ARE SHADED

SIZE		1210					1812					1825					2220					2225				
Soldering		Reflow Only					Reflow Only					Reflow Only					Reflow Only					Reflow Only				
Packaging		Paper/Embossed					All Embossed					All Embossed					All Embossed					All Embossed				
(L) Length	mm (in.)	3.20 ± 0.20 (0.126 ± 0.008)					4.50 ± 0.30 (0.177 ± 0.012)					4.50 ± 0.30 (0.177 ± 0.012)					5.70 ± 0.40 (0.225 ± 0.016)					5.72 ± 0.25 (0.225 ± 0.010)				
(W) Width	mm (in.)	2.50 ± 0.20 (0.098 ± 0.008)					3.20 ± 0.20 (0.126 ± 0.008)					6.40 ± 0.40 (0.252 ± 0.016)					5.00 ± 0.40 (0.197 ± 0.016)					6.35 ± 0.25 (0.250 ± 0.010)				
(t) Terminal	mm (in.)	0.50 ± 0.25 (0.020 ± 0.010)					0.61 ± 0.36 (0.024 ± 0.014)					0.61 ± 0.36 (0.024 ± 0.014)					0.64 ± 0.39 (0.025 ± 0.015)					0.64 ± 0.39 (0.025 ± 0.015)				
WVDC		25	50	100	200	500	25	50	100	200	500	50	100	200	50	100	200	50	100	200	50	100	200			
Cap (pF)	0.5																									
	1.0																									
	1.2																									
	1.5																									
	1.8																									
	2.2																									
	2.7																									
	3.3																									
	3.9																									
	4.7																									
	5.6																									
	6.8																									
	8.2																									
	10					J																				
	12					J																				
	15					J																				
	18					J																				
	22					J																				
	27					J																				
	33					J																				
	39					J																				
	47					J																				
	56					J																				
	68					J																				
	82					J																				
	100					J																				
	120					J																				
	150					J																				
	180					J																				
	220					J																				
	270					J																				
	330					J																				
	390					M																				
	470					M																				
	560	J	J	J	J	M																				
	680	J	J	J	J	M																				
	820	J	J	J	J	M																				
	1000	J	J	J	J	M	K	K	K	K	M	M	M	M							M	M	P			
	1200	J	J	J	M	M	K	K	K	K	M	M	M	M							M	M	P			
	1500	J	J	J	M	M	K	K	K	K	M	M	M	M							M	M	P			
	1800	J	J	J	M		K	K	K	K	M	M	M	M							M	M	P			
	2200	J	J	J	Q		K	K	K	K	P	M	M	M							M	M	P			
	2700	J	J	J	Q		K	K	K	P	Q	M	M	M							M	M	P			
	3300	J	J	J			K	K	K	P	Q	M	M	M				X			M	M	P			
	3900	J	J	M			K	K	K	P	Q	M	M	M				X			M	M	P			
	4700	J	J	M			K	K	K	P	Q	M	M	M	X	X		X			M	M	P			
	5600	J	J				K	K	M	P	X	M	M	M	X	X	X	X			M	M	P			
	6800	J	J				K	K	M	X		M	M	M	X	X	X	X			M	M	P			
	8200	J	J				K	M	M		M	M	M	X	X	X	X			M	M	P				
Cap (µF)	0.010	J	J				K	M	M		M	M	M	X	X	X	X			M	M	P				
	0.012	J	J				K	M			M	M	M	X	X	X	X			M	M	P				
	0.015						M	M			M	M	M	X	X	X	X			M	M	Y				
	0.018						M	M			P	M		X	X	X				M	M	Y				
	0.022						M	M			P			X	X					M	Y	Y				
	0.027						M	M			P			X	X					P	Y	Y				
	0.033						M	M			P			X	X					P						
	0.039						M	M			P			Y						P						
	0.047						M	M			P			Y						P						
	0.068						M	M												P						
	0.082						M	M												Q						
	0.1																			Q						
WVDC		25	50	100	200	500	25	50	100	200	500	50	100	200	50	100	200	50	100	200	50	100	200			
SIZE		1210					1812					1825					2220					2225				
Letter		A	C	E	G	J	K	M	N	P	Q	X	Y	Z												
Max. Thickness		0.33 (0.013)	0.56 (0.022)	0.71 (0.028)	0.90 (0.035)	0.94 (0.037)	1.02 (0.040)	1.27 (0.050)	1.40 (0.055)	1.52 (0.060)	1.78 (0.070)	2.29 (0.090)	2.54 (0.100)	2.79 (0.110)												
		PAPER					EMBOSSSED																			

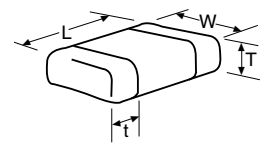



# RF/Microwave COG (NP0) Capacitors (RoHS)



## Ultra Low ESR, "U" Series, COG (NP0) Chip Capacitors

### GENERAL INFORMATION

"U" Series capacitors are COG (NP0) chip capacitors specially designed for "Ultra" low ESR for applications in the communications market. Max ESR and effective capacitance

are met on each value producing lot to lot uniformity. Sizes available are EIA chip sizes 0402, 0603, 0805, and 1210.

### DIMENSIONS: inches (millimeters)

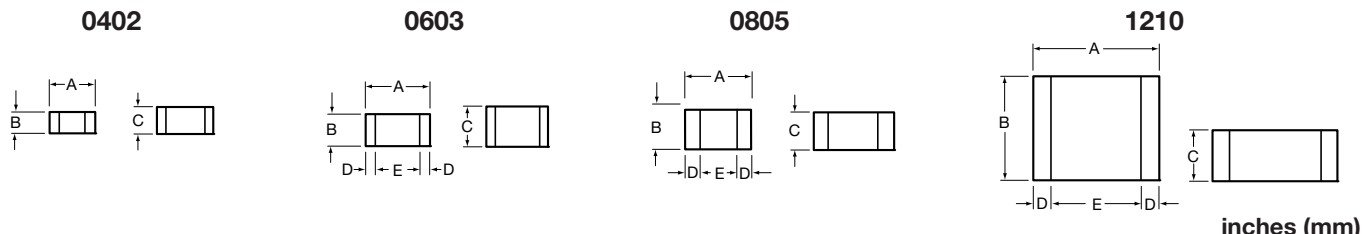

Size	A	B	C	D	E
0402	0.039±0.004 (1.00±0.1)	0.020±0.004 (0.50±0.1)	0.024 (0.6) max	N/A	N/A
0603	0.060±0.010 (1.52±0.25)	0.030±0.010 (0.76±0.25)	0.036 (0.91) max	0.010±0.005 (0.25±0.13)	0.030 (0.76) min
0805	0.079±0.008 (2.01±0.2)	0.049±0.008 (1.25±0.2)	0.040±0.005 (1.02±0.127)	0.020±0.010 (0.51±0.255)	0.020 (0.51) min
1210	0.126±0.008 (3.2±0.2)	0.098±0.008 (2.49±0.2)	0.050±0.005 (1.27±0.127)	0.025±0.015 (0.635±0.381)	0.040 (1.02) min

### HOW TO ORDER

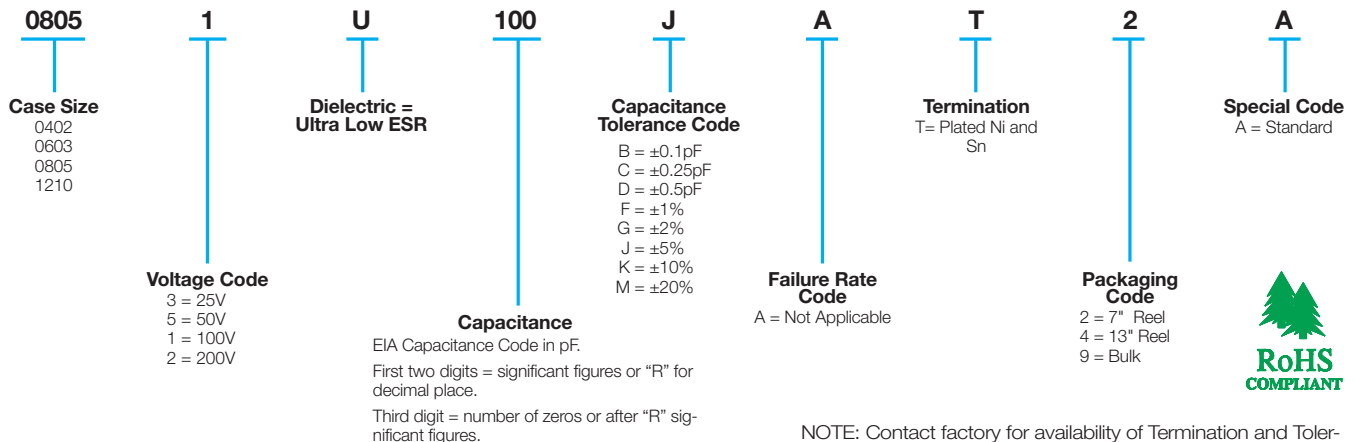

NOTE: Contact factory for availability of Termination and Tolerance Options for Specific Part Numbers.

### ELECTRICAL CHARACTERISTICS

#### Capacitance Values and Tolerances:

- Size 0402 - 0.2 pF to 22 pF @ 1 MHz
- Size 0603 - 1.0 pF to 100 pF @ 1 MHz
- Size 0805 - 1.6 pF to 160 pF @ 1 MHz
- Size 1210 - 2.4 pF to 1000 pF @ 1 MHz

#### Temperature Coefficient of Capacitance (TC):

0±30 ppm/°C (-55° to +125°C)

#### Insulation Resistance (IR):

- 10<sup>12</sup> Ω min. @ 25°C and rated WVDC
- 10<sup>11</sup> Ω min. @ 125°C and rated WVDC

#### Working Voltage (WVDC):

- Size Working Voltage
- 0402 - 50, 25 WVDC
- 0603 - 200, 100, 50 WVDC
- 0805 - 200, 100 WVDC
- 1210 - 200, 100 WVDC

#### Dielectric Working Voltage (DWV):

250% of rated WVDC

#### Equivalent Series Resistance Typical (ESR):

- 0402 - See Performance Curve, page 9
- 0603 - See Performance Curve, page 9
- 0805 - See Performance Curve, page 9
- 1210 - See Performance Curve, page 9

#### Marking: Laser marking EIA J marking standard

(except 0603) (capacitance code and tolerance upon request).

#### MILITARY SPECIFICATIONS

Meets or exceeds the requirements of MIL-C-55681

# RF/Microwave C0G (NP0) Capacitors (RoHS)



## Ultra Low ESR, "U" Series, C0G (NP0) Chip Capacitors

### CAPACITANCE RANGE

Cap (pF)	Available Tolerance	Size				Cap (pF)	Available Tolerance	Size				Cap (pF)	Available Tolerance	Size			
		0402	0603	0805	1210			0402	0603	0805	1210			0402	0603	0805	1210
0.2	B,C	50V	N/A	N/A	N/A	1.0	B,C,D	50V	200V	200V	200V	100	F,G,J,K,M	N/A	100V	200V	200V
0.3						1.1						110			50V	200V	200V
0.4	B,C					1.2						120			50V	200V	200V
0.5	B,C					1.3						130			N/A	200V	200V
0.6	B,C,D					1.4						140				100V	200V
0.7						1.5						150				100V	200V
0.8	B,C,D					1.6						160				100V	200V
0.9						1.7						180				N/A	200V
						1.8						200					200V
						1.9						220					200V
						2.0						270					200V
						2.1						300					200V
						2.2						330					200V
						2.4						360					200V
						2.7						390					200V
						3.0						430					200V
						3.3						470					200V
						3.6						510					200V
						3.9						560					200V
						4.3						620					200V
						4.7						680					200V
						5.1						750					200V
						5.6						820					200V
						6.2	B,C,D					910					200V
						6.8	B,C,J,K,M					1000	F,G,J,K,M				200V



### ULTRA LOW ESR, "U" SERIES

TYPICAL ESR vs. FREQUENCY  
0402 "U" SERIES

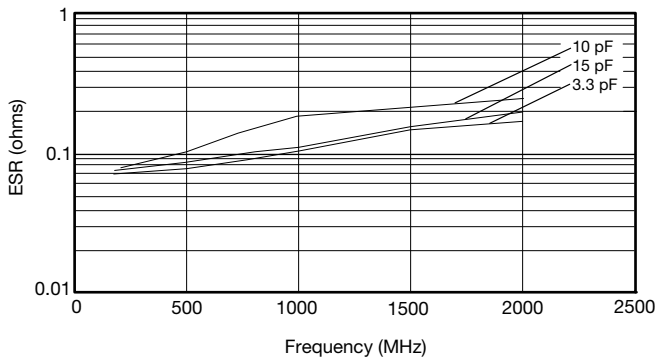

TYPICAL ESR vs. FREQUENCY  
0603 "U" SERIES

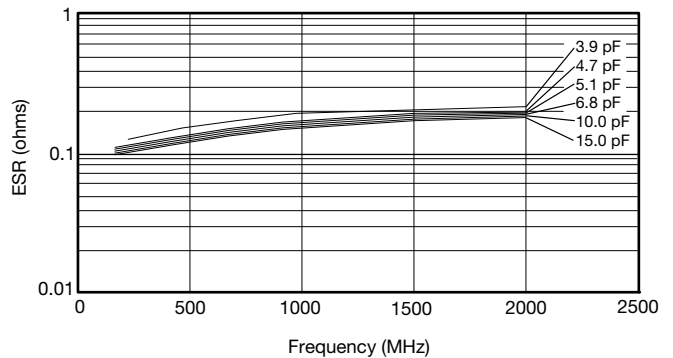

TYPICAL ESR vs. FREQUENCY  
0805 "U" SERIES

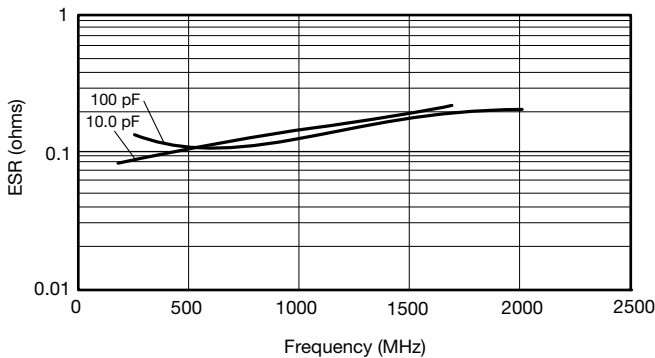

TYPICAL ESR vs. FREQUENCY  
1210 "U" SERIES

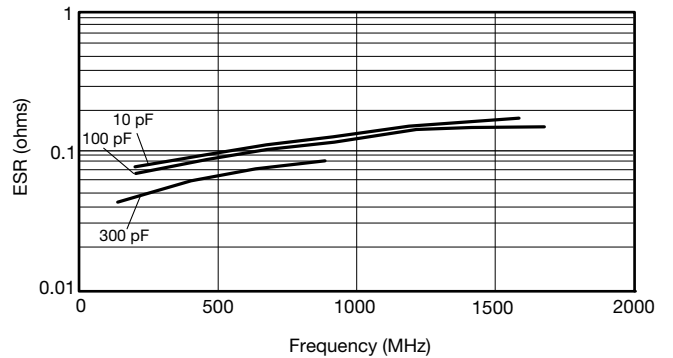

ESR Measured on the Boonton 34A



# RF/Microwave C0G (NP0) Capacitors



Ultra Low ESR, "U" Series, C0G (NP0) Chip Capacitors

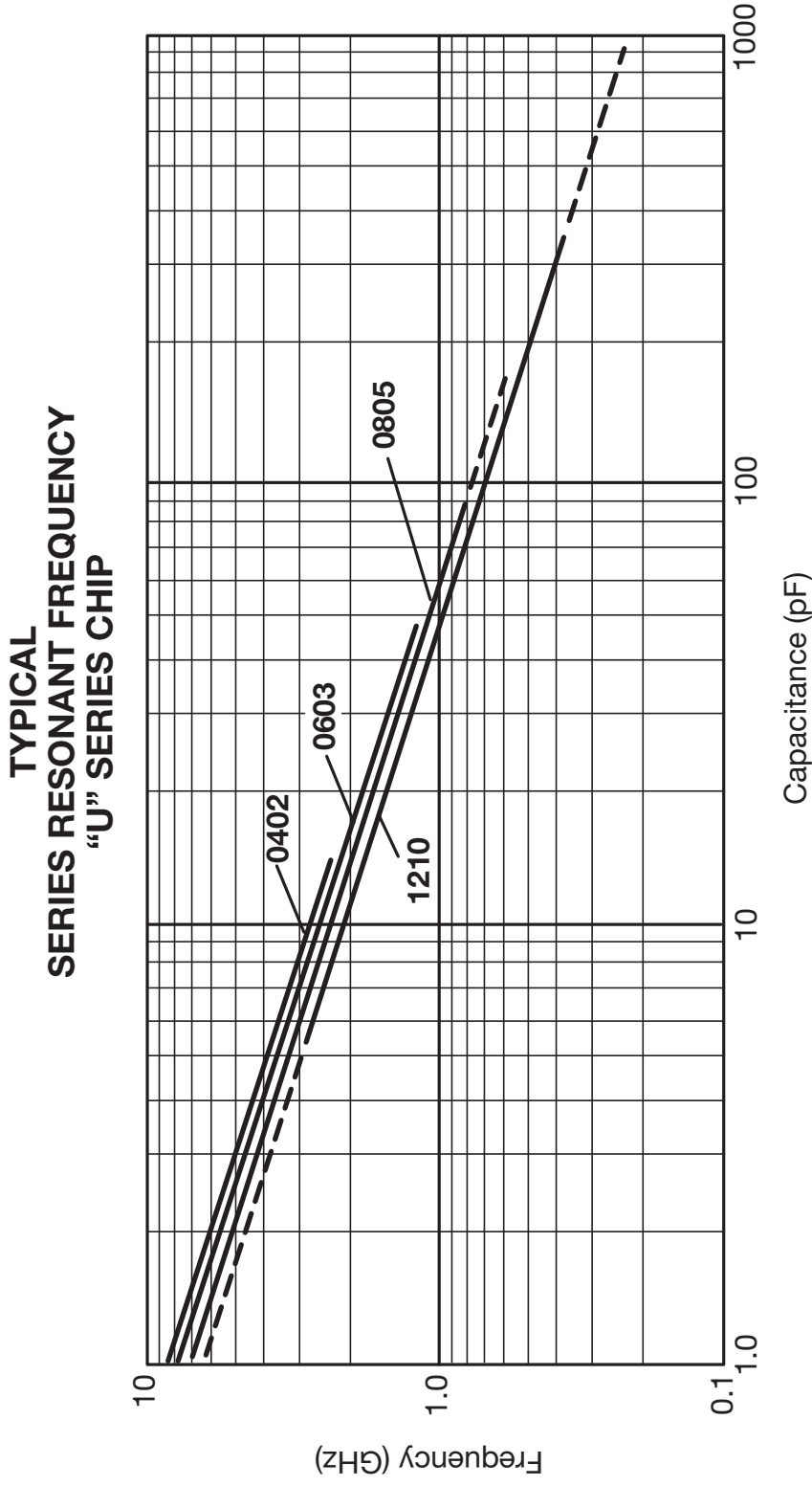

# RF/Microwave C0G (NP0) Capacitors (Sn/Pb)

## Ultra Low ESR, "U" Series, C0G (NP0) Chip Capacitors

### GENERAL INFORMATION

"U" Series capacitors are C0G (NP0) chip capacitors specially designed for "Ultra" low ESR for applications in the communications market. Max ESR and effective capacitance

are met on each value producing lot to lot uniformity. Sizes available are EIA chip sizes 0402, 0603, 0805, and 1210.

### DIMENSIONS: inches (millimeters)

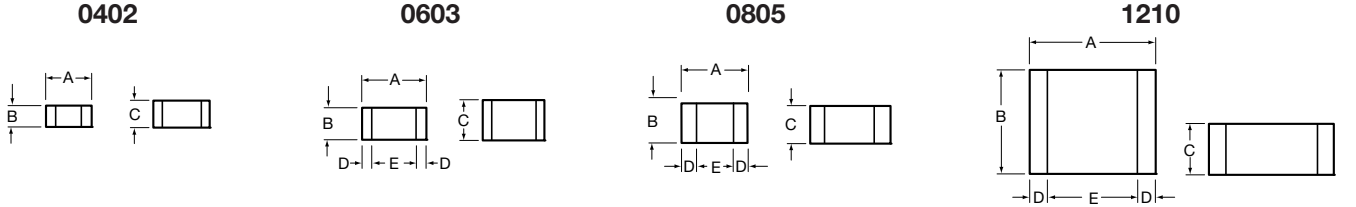

Size	A	B	C	D	E
0402	0.039±0.004 (1.00±0.1)	0.020±0.004 (0.50±0.1)	0.024 (0.6) max	N/A	N/A
0603	0.060±0.010 (1.52±0.25)	0.030±0.010 (0.76±0.25)	0.036 (0.91) max	0.010±0.005 (0.25±0.13)	0.030 (0.76) min
0805	0.079±0.008 (2.01±0.2)	0.049±0.008 (1.25±0.2)	0.040±0.005 (1.02±0.127)	0.020±0.010 (0.51±0.254)	0.020 (0.51) min
1210	0.126±0.008 (3.2±0.2)	0.098±0.008 (2.49±0.2)	0.050±0.005 (1.27±0.127)	0.025±0.015 (0.635±0.381)	0.040 (1.02) min

### HOW TO ORDER

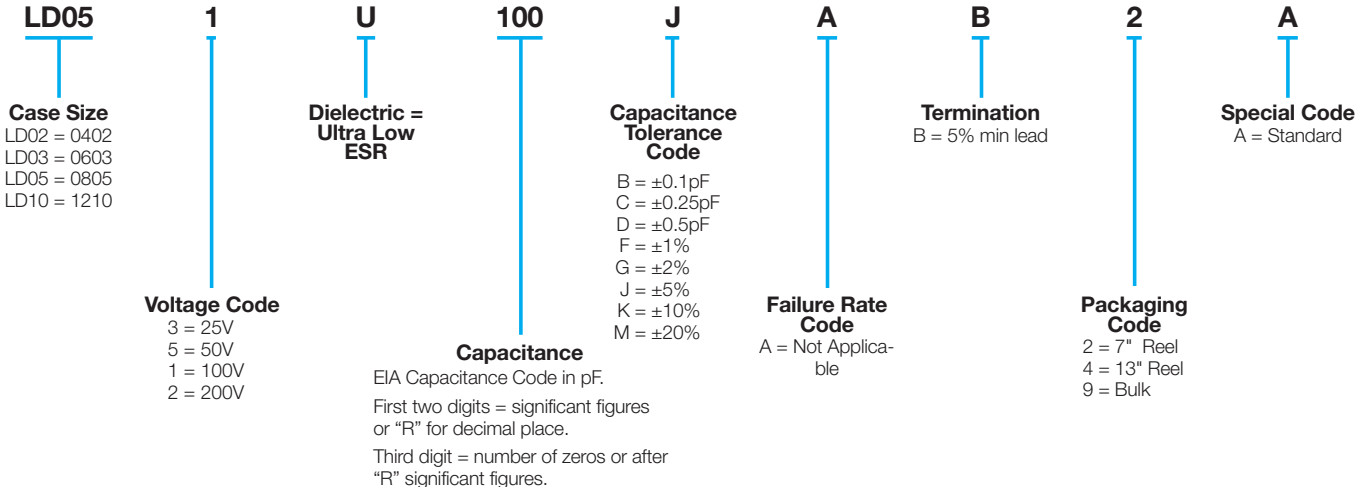

### ELECTRICAL CHARACTERISTICS

#### Capacitance Values and Tolerances:

- Size 0402 - 0.2 pF to 22 pF @ 1 MHz
- Size 0603 - 1.0 pF to 100 pF @ 1 MHz
- Size 0805 - 1.6 pF to 160 pF @ 1 MHz
- Size 1210 - 2.4 pF to 1000 pF @ 1 MHz

#### Temperature Coefficient of Capacitance (TC):

0±30 ppm/°C (-55° to +125°C)

#### Insulation Resistance (IR):

10<sup>12</sup> Ω min. @ 25°C and rated WVDC  
10<sup>11</sup> Ω min. @ 125°C and rated WVDC

#### Working Voltage (WVDC):

- Size Working Voltage
- 0402 - 50, 25 WVDC
- 0603 - 200, 100, 50 WVDC
- 0805 - 200, 100 WVDC
- 1210 - 200, 100 WVDC

#### Dielectric Working Voltage (DWV):

250% of rated WVDC

#### Equivalent Series Resistance Typical (ESR):

- 0402 - See Performance Curve, page 12
- 0603 - See Performance Curve, page 12
- 0805 - See Performance Curve, page 12
- 1210 - See Performance Curve, page 12

**Marking:** Laser marking EIA J marking standard (except 0603) (capacitance code and tolerance upon request).

#### MILITARY SPECIFICATIONS

Meets or exceeds the requirements of MIL-C-55681

**Not RoHS Compliant**

# RF/Microwave C0G (NP0) Capacitors (Sn/Pb)



## Ultra Low ESR, "U" Series, C0G (NP0) Chip Capacitors

### CAPACITANCE RANGE

Cap (pF)	Available Tolerance	Size				Cap (pF)	Available Tolerance	Size				Cap (pF)	Available Tolerance	Size				Cap (pF)	Available Tolerance	Size																																																																																																																																																																																																																																																																																																																																																																																																																																																																																																																																																									
		LD02	LD03	LD05	LD10			LD02	LD03	LD05	LD10			LD02	LD03	LD05	LD10			LD02	LD03	LD05	LD10																																																																																																																																																																																																																																																																																																																																																																																																																																																																																																																																																						
0.2	B,C	50V	N/A	N/A	N/A	1.0	B,C,D	50V	200V	200V	200V	100	F,G,J,K,M	N/A	100V	200V	200V	110		N/A	100V	200V	200V	120		N/A	100V	200V	200V	130		N/A	100V	200V	200V	140		N/A	100V	200V	200V	150		N/A	100V	200V	200V	160		N/A	100V	200V	200V	170		N/A	100V	200V	200V	180		N/A	100V	200V	200V	190		N/A	100V	200V	200V	200		N/A	100V	200V	200V	210		N/A	100V	200V	200V	220		N/A	100V	200V	200V	230		N/A	100V	200V	200V	240		N/A	100V	200V	200V	250		N/A	100V	200V	200V	260		N/A	100V	200V	200V	270		N/A	100V	200V	200V	280		N/A	100V	200V	200V	290		N/A	100V	200V	200V	300		N/A	100V	200V	200V	310		N/A	100V	200V	200V	320		N/A	100V	200V	200V	330		N/A	100V	200V	200V	340		N/A	100V	200V	200V	350		N/A	100V	200V	200V	360		N/A	100V	200V	200V	370		N/A	100V	200V	200V	380		N/A	100V	200V	200V	390		N/A	100V	200V	200V	400		N/A	100V	200V	200V	410		N/A	100V	200V	200V	420		N/A	100V	200V	200V	430		N/A	100V	200V	200V	440		N/A	100V	200V	200V	450		N/A	100V	200V	200V	460		N/A	100V	200V	200V	470		N/A	100V	200V	200V	480		N/A	100V	200V	200V	490		N/A	100V	200V	200V	500		N/A	100V	200V	200V	510		N/A	100V	200V	200V	520		N/A	100V	200V	200V	530		N/A	100V	200V	200V	540		N/A	100V	200V	200V	550		N/A	100V	200V	200V	560		N/A	100V	200V	200V	570		N/A	100V	200V	200V	580		N/A	100V	200V	200V	590		N/A	100V	200V	200V	600		N/A	100V	200V	200V	610		N/A	100V	200V	200V	620		N/A	100V	200V	200V	630		N/A	100V	200V	200V	640		N/A	100V	200V	200V	650		N/A	100V	200V	200V	660		N/A	100V	200V	200V	670		N/A	100V	200V	200V	680		N/A	100V	200V	200V	690		N/A	100V	200V	200V	700		N/A	100V	200V	200V	710		N/A	100V	200V	200V	720		N/A	100V	200V	200V	730		N/A	100V	200V	200V	740		N/A	100V	200V	200V	750		N/A	100V	200V	200V	760		N/A	100V	200V	200V	770		N/A	100V	200V	200V	780		N/A	100V	200V	200V	790		N/A	100V	200V	200V	800		N/A	100V	200V	200V	810		N/A	100V	200V	200V	820		N/A	100V	200V	200V	830		N/A	100V	200V	200V	840		N/A	100V	200V	200V	850		N/A	100V	200V	200V	860		N/A	100V	200V	200V	870		N/A	100V	200V	200V	880		N/A	100V	200V	200V	890		N/A	100V	200V	200V	900		N/A	100V	200V	200V	910		N/A	100V	200V	200V	920		N/A	100V	200V	200V	930		N/A	100V	200V	200V	940		N/A	100V	200V	200V	950		N/A	100V	200V	200V	960		N/A	100V	200V	200V	970		N/A	100V	200V	200V	980		N/A	100V	200V	200V	990		N/A	100V	200V	200V	1000		N/A	100V	200V	200V

### ULTRA LOW ESR, "U" SERIES

TYPICAL ESR vs. FREQUENCY  
0402 "U" SERIES

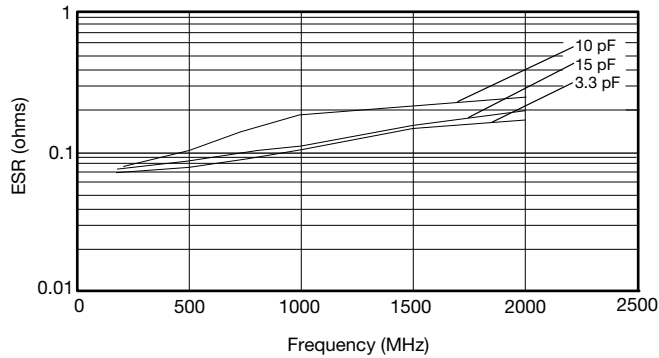

TYPICAL ESR vs. FREQUENCY  
0603 "U" SERIES

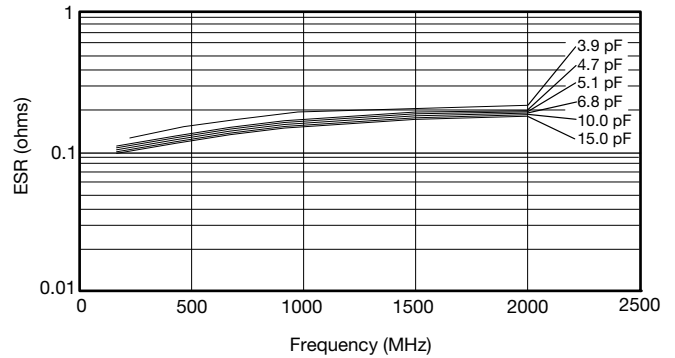

TYPICAL ESR vs. FREQUENCY  
0805 "U" SERIES

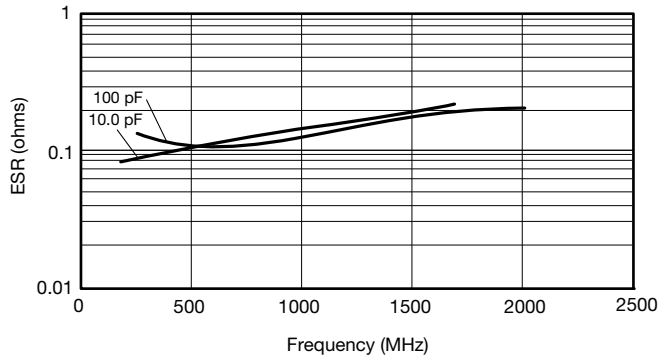

TYPICAL ESR vs. FREQUENCY  
1210 "U" SERIES

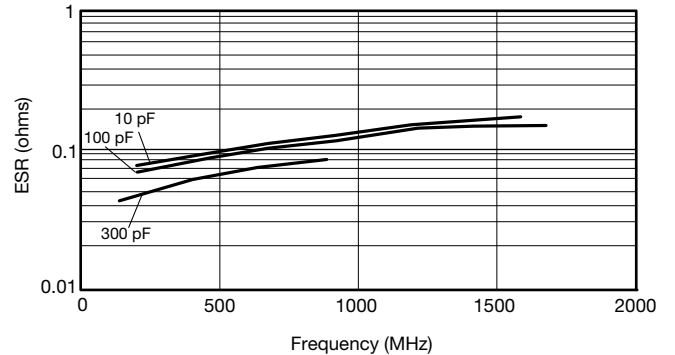

ESR Measured on the Boonton 34A



### “U” SERIES KITS

#### 0402

Kit 5000 UZ			
Cap. Value pF	Tolerance	Cap. Value pF	Tolerance
0.5	B ( $\pm 0.1\text{pF}$ )	4.7	B ( $\pm 0.1\text{pF}$ )
1.0		5.6	
1.5		6.8	
1.8		8.2	
2.2		10.0	
2.4	J ( $\pm 5\%$ )	12.0	J ( $\pm 5\%$ )
3.0		15.0	
3.6			

\*\*\*25 each of 15 values

#### 0603

Kit 4000 UZ			
Cap. Value pF	Tolerance	Cap. Value pF	Tolerance
1.0	B ( $\pm 0.1\text{pF}$ )	6.8	B ( $\pm 0.1\text{pF}$ )
1.2		7.5	
1.5		8.2	
1.8		10.0	J ( $\pm 5\%$ )
2.0		12.0	
2.4		15.0	
2.7		18.0	
3.0		22.0	
3.3		27.0	
3.9		33.0	
4.7	39.0		
5.6	47.0		

\*\*\*25 each of 24 values

#### 0805

Kit 3000 UZ					
Cap. Value pF	Tolerance	Cap. Value pF	Tolerance		
1.0	B ( $\pm 0.1\text{pF}$ )	15.0	J ( $\pm 5\%$ )		
1.5		18.0			
2.2		22.0			
2.4		24.0			
2.7		27.0			
3.0		33.0			
3.3		36.0			
3.9		39.0			
4.7		47.0			
5.6		56.0			
7.5		68.0			
8.2		82.0			
9.1		100.0			
10.0		J ( $\pm 5\%$ )		130.0	J ( $\pm 5\%$ )
12.0				160.0	

\*\*\*25 each of 30 values

#### 1210

Kit 3500 UZ				
Cap. Value pF	Tolerance	Cap. Value pF	Tolerance	
2.2	B ( $\pm 0.1\text{pF}$ )	36.0	J ( $\pm 5\%$ )	
2.7		39.0		
4.7		47.0		
5.1		51.0		
6.8		56.0		
8.2		68.0		
9.1		82.0		
10.0		J ( $\pm 5\%$ )		100.0
13.0	120.0			
15.0	130.0			
18.0	240.0			
20.0	300.0			
24.0	390.0			
27.0	470.0			
30.0	680.0			

\*\*\*25 each of 30 values

# X8R/X8L Dielectric



## General Specifications

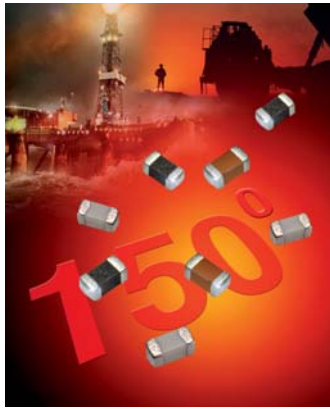

AVX has developed a range of multilayer ceramic capacitors designed for use in applications up to 150°C. These capacitors are manufactured with an X8R and an X8L dielectric material. X8R material has capacitance variation of ±15% between -55°C and +150°C. The X8L material has capacitance variation of ±15% between -55°C to 125°C and +15/-40% from +125°C to +150°C.

The need for X8R and X8L performance has been driven by customer requirements for parts that operate at elevated temperatures. They provide a highly reliable capacitor with low loss and stable capacitance over temperature.

They are ideal for automotive under the hood sensors, and various industrial applications. Typical industrial application would be drilling monitoring system. They can also be used as bulk capacitors for high temperature camera modules.

Both X8R and X8L dielectric capacitors are automotive AEC-Q200 qualified. Optional termination systems, tin, FLEXITERM® and conductive epoxy for hybrid applications are available. Providing this series with our FLEXITERM® termination system provides further advantage to customers by way of enhanced resistance to both, temperature cycling and mechanical damage.

### PART NUMBER (see page 2 for complete part number explanation)

**0805**

**Size**  
0603  
0805  
1206

**5**

**Voltage**  
16V = Y  
25V = 3  
50V = 5  
100V = 1

**F**

**Dielectric**  
X8R = F  
X8L = L

**104**

**Capacitance Code (In pF)**  
2 Sig. Digits + Number of Zeros  
e.g. 10µF = 106

**K**

**Capacitance Tolerance**  
J = ± 5%  
K = ±10%  
M = ± 20%

**4**

**Failure Rate**  
4 = Automotive  
A = Not Applicable

**T**

**Terminations**  
T = Plated Ni and Sn  
Z = FLEXITERM®  
U = Conductive Epoxy for Hybrid apps

**2**

**Packaging**  
2 = 7" Reel  
4 = 13" Reel

**A**

**Special Code**  
A = Std. Product

NOTE: Contact factory for availability of Termination and Tolerance Options for Specific Part Numbers.



### X8R

SIZE	WVDC	0603		0805		1206	
		25V	50V	25V	50V	25V	50V
331	Cap 330	G	G	J	J		
471	470	G	G	J	J		
681	680	G	G	J	J		
102	1000	G	G	J	J	J	J
152	1500	G	G	J	J	J	J
222	2200	G	G	J	J	J	J
332	3300	G	G	J	J	J	J
472	4700	G	G	J	J	J	J
682	6800	G	G	J	J	J	J
103	Cap 0.01	G	G	J	J	J	J
153	0.015	G	G	J	J	J	J
223	0.022	G	G	J	J	J	J
333	0.033	G	G	J	J	J	J
473	0.047	G	G	J	J	J	J
683	0.068	G		N	N	M	M
104	0.1			N	N	M	M
154	0.15			N	N	M	M
224	0.22			N		M	M
334	0.33					M	M
474	0.47					M	
684	0.68						
105	1						
SIZE	WVDC	25V	50V	25V	50V	25V	50V

### X8L

SIZE	WVDC	0603			0805			1206			
		25V	50V	100V	25V	50V	100V	16V	25V	50V	100V
331	Cap 330		G	G		J	J				
471	470		G	G		J	J				
681	680		G	G		J	J				
102	1000		G	G		J	J				
152	1500		G	G		J	J			J	J
222	2200		G	G		J	J			J	J
332	3300		G	G		J	J			J	J
472	4700		G	G		J	J			J	J
682	6800		G	G		J	J			J	J
103	Cap 0.01		G	G		J	J			J	J
153	0.015		G	G		J	J			J	J
223	0.022		G	G		J	J			J	J
333	0.033		G	G		J	J	N		J	J
473	0.047		G	G		J	J	N		J	J
683	0.068		G	G		J	J			J	J
104	0.1		G	G		J	J			J	M
154	0.15					J	N			J	Q
224	0.22					N	N			J	Q
334	0.33					N				J	Q
474	0.47					N				M	P
684	0.68									M	
105	1									M	
SIZE	WVDC	25V	50V	100V	25V	50V	100V	16V	25V	50V	100V

Letter	A	C	E	G	J	K	M	N	P	Q	X	Y	Z
Max. Thickness	0.33 (0.013)	0.56 (0.022)	0.71 (0.028)	0.90 (0.035)	0.94 (0.037)	1.02 (0.040)	1.27 (0.050)	1.40 (0.055)	1.52 (0.060)	1.78 (0.070)	2.29 (0.090)	2.54 (0.100)	2.79 (0.110)
	PAPER					EMBOSSED							

= AEC-Q200 Qualified



# X8R/X8L Dielectric



## General Specifications

### APPLICATIONS FOR X8R AND X8L CAPACITORS

- All market sectors with a 150°C requirement
- Automotive on engine applications
- Oil exploration applications
- Hybrid automotive applications
  - Battery control
  - Inverter / converter circuits
  - Motor control applications
  - Water pump
- Hybrid commercial applications
  - Emergency circuits
  - Sensors
  - Temperature regulation

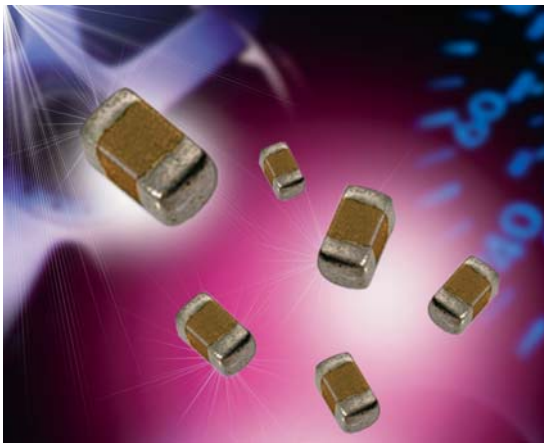

### ADVANTAGES OF X8R AND X8L MLC CAPACITORS

- Both ranges are qualified to the highest automotive AEC-Q200 standards
- Excellent reliability compared to other capacitor technologies
- RoHS compliant
- Low ESR / ESL compared to other technologies
- Tin solder finish
- FLEXITERM® available
- Epoxy termination for hybrid available
- 100V range available

### ENGINEERING TOOLS FOR HIGH VOLTAGE MLC CAPACITORS

- Samples
- Technical Articles
- Application Engineering
- Application Support

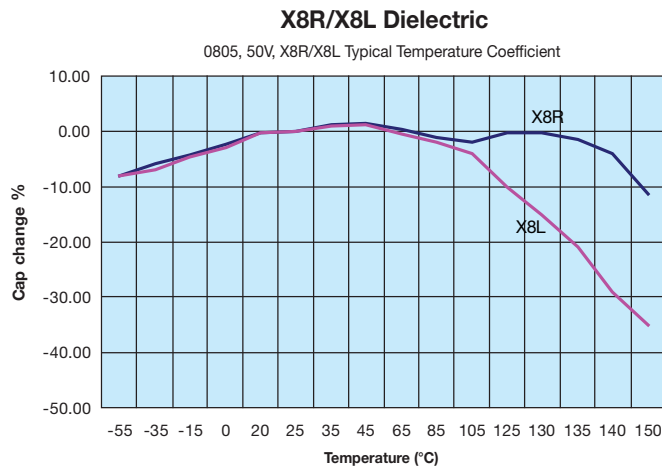



# X8R/X8L Dielectric

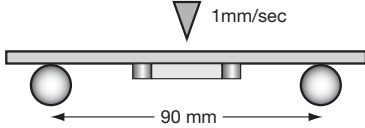

## Specifications and Test Methods

Parameter/Test		X8R/X8L Specification Limits	Measuring Conditions	
<b>Operating Temperature Range</b>		-55°C to +150°C	Temperature Cycle Chamber	
<b>Capacitance</b>		Within specified tolerance	Freq.: 1.0 kHz ± 10%	
<b>Dissipation Factor</b>		≤ 2.5% for ≥ 50V DC rating ≤ 3.5% for 25V DC and 16V DC rating	Voltage: 1.0Vrms ± .2V	
<b>Insulation Resistance</b>		100,000MΩ or 1000MΩ - μF, whichever is less	Charge device with rated voltage for 120 ± 5 secs @ room temp/humidity	
<b>Dielectric Strength</b>		No breakdown or visual defects	Charge device with 300% of rated voltage for 1-5 seconds, w/charge and discharge current limited to 50 mA (max) Note: Charge device with 150% of rated voltage for 500V devices.	
<b>Resistance to Flexure Stresses</b>	Appearance	No defects	Deflection: 2mm Test Time: 30 seconds 	
	Capacitance Variation	≤ ±12%		
	Dissipation Factor	Meets Initial Values (As Above)		
	Insulation Resistance	≥ Initial Value x 0.3		
<b>Solderability</b>		≥ 95% of each terminal should be covered with fresh solder	Dip device in eutectic solder at 230 ± 5°C for 5.0 ± 0.5 seconds	
<b>Resistance to Solder Heat</b>	Appearance	No defects, <25% leaching of either end terminal	Dip device in eutectic solder at 260°C for 60 seconds. Store at room temperature for 24 ± 2 hours before measuring electrical properties.	
	Capacitance Variation	≤ ±7.5%		
	Dissipation Factor	Meets Initial Values (As Above)		
	Insulation Resistance	Meets Initial Values (As Above)		
	Dielectric Strength	Meets Initial Values (As Above)		
<b>Thermal Shock</b>	Appearance	No visual defects	Step 1: -55°C ± 2°	30 ± 3 minutes
	Capacitance Variation	≤ ±7.5%	Step 2: Room Temp	≤ 3 minutes
	Dissipation Factor	Meets Initial Values (As Above)	Step 3: +125°C ± 2°	30 ± 3 minutes
	Insulation Resistance	Meets Initial Values (As Above)	Step 4: Room Temp	≤ 3 minutes
	Dielectric Strength	Meets Initial Values (As Above)	Repeat for 5 cycles and measure after 24 ± 2 hours at room temperature	
<b>Load Life</b>	Appearance	No visual defects	Charge device with 1.5 rated voltage (≤ 10V) in test chamber set at 150°C ± 2°C for 1000 hours (+48, -0)  Remove from test chamber and stabilize at room temperature for 24 ± 2 hours before measuring.	
	Capacitance Variation	≤ ±12.5%		
	Dissipation Factor	≤ Initial Value x 2.0 (See Above)		
	Insulation Resistance	≥ Initial Value x 0.3 (See Above)		
	Dielectric Strength	Meets Initial Values (As Above)		
<b>Load Humidity</b>	Appearance	No visual defects	Store in a test chamber set at 85°C ± 2°C/ 85% ± 5% relative humidity for 1000 hours (+48, -0) with rated voltage applied.  Remove from chamber and stabilize at room temperature and humidity for 24 ± 2 hours before measuring.	
	Capacitance Variation	≤ ±12.5%		
	Dissipation Factor	≤ Initial Value x 2.0 (See Above)		
	Insulation Resistance	≥ Initial Value x 0.3 (See Above)		
	Dielectric Strength	Meets Initial Values (As Above)		

# X7R Dielectric

## General Specifications

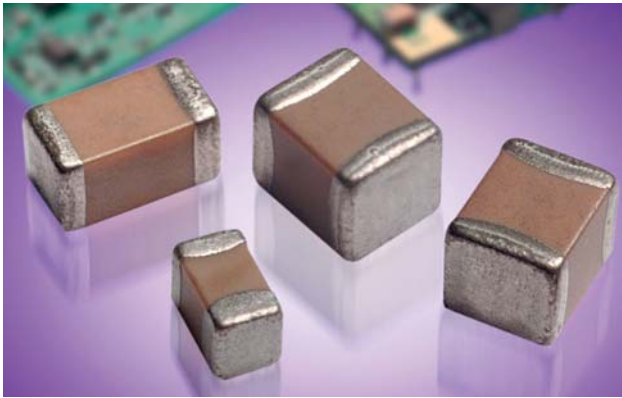

X7R formulations are called “temperature stable” ceramics and fall into EIA Class II materials. X7R is the most popular of these intermediate dielectric constant materials. Its temperature variation of capacitance is within  $\pm 15\%$  from  $-55^{\circ}\text{C}$  to  $+125^{\circ}\text{C}$ . This capacitance change is non-linear.

Capacitance for X7R varies under the influence of electrical operating conditions such as voltage and frequency.

X7R dielectric chip usage covers the broad spectrum of industrial applications where known changes in capacitance due to applied voltages are acceptable.



### PART NUMBER (see page 2 for complete part number explanation)

<b>0805</b>	<b>5</b>	<b>C</b>	<b>103</b>	<b>M</b>	<b>A</b>	<b>T</b>	<b>2</b>	<b>A</b>
<b>Size</b> (L" x W")	<b>Voltage</b> 4V = 4 6.3V = 6 10V = Z 16V = Y 25V = 3 50V = 5 100V = 1 200V = 2 500V = 7	<b>Dielectric</b> X7R = C	<b>Capacitance Code (In pF)</b> 2 Sig. Digits + Number of Zeros	<b>Capacitance Tolerance</b> J = $\pm 5\%$ * K = $\pm 10\%$ M = $\pm 20\%$	<b>Failure Rate</b> A = Not Applicable	<b>Terminations</b> T = Plated Ni and Sn 7 = Gold Plated* Z = FLEXITERM®**	<b>Packaging</b> 2 = 7" Reel 4 = 13" Reel 7 = Bulk Cass. 9 = Bulk	<b>Special Code</b> A = Std. Product
				* $\leq 1\mu\text{F}$ only, contact factory for additional values		*Optional termination		<b>Contact Factory For Multiples</b>
						**See FLEXITERM® X7R section		

NOTE: Contact factory for availability of Termination and Tolerance Options for Specific Part Numbers.  
Contact factory for non-specified capacitance values.

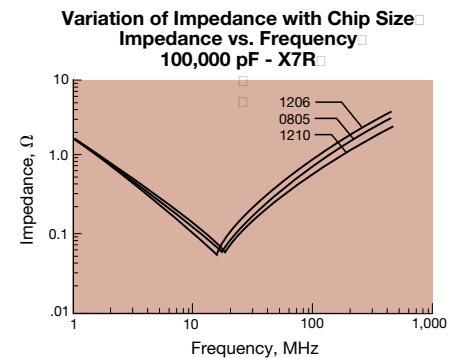
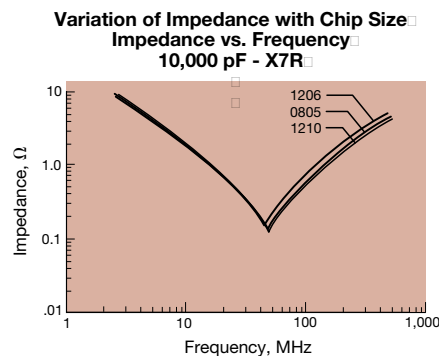
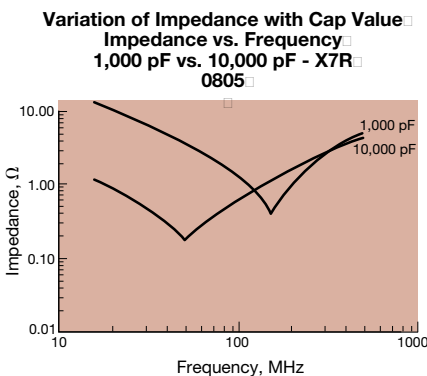
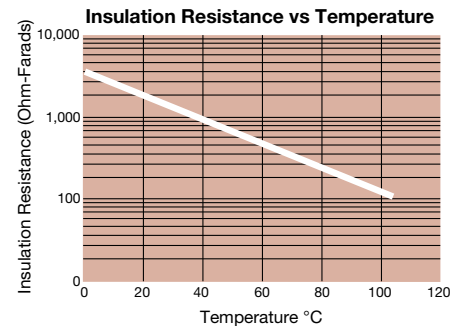
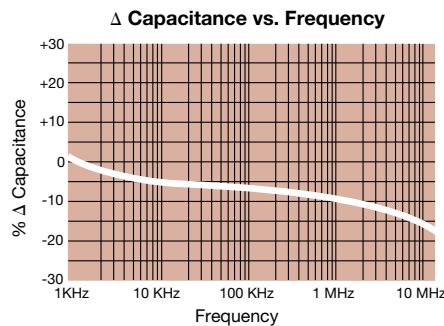
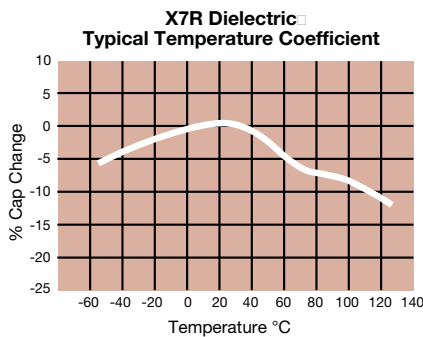

## Specifications and Test Methods

Parameter/Test		X7R Specification Limits	Measuring Conditions	
<b>Operating Temperature Range</b>		-55°C to +125°C	Temperature Cycle Chamber	
<b>Capacitance</b>		Within specified tolerance		
<b>Dissipation Factor</b>		$\leq 2.5\%$ for $\geq 50V$ DC rating $\leq 3.0\%$ for 25V DC rating $\leq 3.5\%$ for 25V and 16V DC rating $\leq 5.0\%$ for $\leq 10V$ DC rating	Freq.: 1.0 kHz $\pm$ 10% Voltage: 1.0Vrms $\pm$ .2V	
<b>Insulation Resistance</b>		100,000M $\Omega$ or 1000M $\Omega$ - $\mu$ F, whichever is less	Charge device with rated voltage for 120 $\pm$ 5 secs @ room temp/humidity	
<b>Dielectric Strength</b>		No breakdown or visual defects	Charge device with 300% of rated voltage for 1-5 seconds, w/charge and discharge current limited to 50 mA (max) Note: Charge device with 150% of rated voltage for 500V devices.	
<b>Resistance to Flexure Stresses</b>	Appearance	No defects	Deflection: 2mm Test Time: 30 seconds 	
	Capacitance Variation	$\leq \pm 12\%$		
	Dissipation Factor	Meets Initial Values (As Above)		
	Insulation Resistance	$\geq$ Initial Value $\times$ 0.3		
<b>Solderability</b>		$\geq 95\%$ of each terminal should be covered with fresh solder	Dip device in eutectic solder at 230 $\pm$ 5°C for 5.0 $\pm$ 0.5 seconds	
<b>Resistance to Solder Heat</b>	Appearance	No defects, <25% leaching of either end terminal	Dip device in eutectic solder at 260°C for 60 seconds. Store at room temperature for 24 $\pm$ 2 hours before measuring electrical properties.	
	Capacitance Variation	$\leq \pm 7.5\%$		
	Dissipation Factor	Meets Initial Values (As Above)		
	Insulation Resistance	Meets Initial Values (As Above)		
	Dielectric Strength	Meets Initial Values (As Above)		
<b>Thermal Shock</b>	Appearance	No visual defects	Step 1: -55°C $\pm$ 2°	30 $\pm$ 3 minutes
	Capacitance Variation	$\leq \pm 7.5\%$	Step 2: Room Temp	$\leq 3$ minutes
	Dissipation Factor	Meets Initial Values (As Above)	Step 3: +125°C $\pm$ 2°	30 $\pm$ 3 minutes
	Insulation Resistance	Meets Initial Values (As Above)	Step 4: Room Temp	$\leq 3$ minutes
	Dielectric Strength	Meets Initial Values (As Above)	Repeat for 5 cycles and measure after 24 $\pm$ 2 hours at room temperature	
<b>Load Life</b>	Appearance	No visual defects	Charge device with 1.5 rated voltage ( $\leq 10V$ ) in test chamber set at 125°C $\pm$ 2°C for 1000 hours (+48, -0)  Remove from test chamber and stabilize at room temperature for 24 $\pm$ 2 hours before measuring.	
	Capacitance Variation	$\leq \pm 12.5\%$		
	Dissipation Factor	$\leq$ Initial Value $\times$ 2.0 (See Above)		
	Insulation Resistance	$\geq$ Initial Value $\times$ 0.3 (See Above)		
	Dielectric Strength	Meets Initial Values (As Above)		
<b>Load Humidity</b>	Appearance	No visual defects	Store in a test chamber set at 85°C $\pm$ 2°C/ 85% $\pm$ 5% relative humidity for 1000 hours (+48, -0) with rated voltage applied.  Remove from chamber and stabilize at room temperature and humidity for 24 $\pm$ 2 hours before measuring.	
	Capacitance Variation	$\leq \pm 12.5\%$		
	Dissipation Factor	$\leq$ Initial Value $\times$ 2.0 (See Above)		
	Insulation Resistance	$\geq$ Initial Value $\times$ 0.3 (See Above)		
	Dielectric Strength	Meets Initial Values (As Above)		

# X7R Dielectric

## Capacitance Range



### PREFERRED SIZES ARE SHADED

SIZE	0101	0201			0402			0603				0805				1206													
Soldering	Reflow Only	Reflow Only			Reflow/Wave			Reflow/Wave				Reflow/Wave				Reflow/Wave													
Packaging	Paper/Embossed	All Paper			All Paper			All Paper				Paper/Embossed				Paper/Embossed													
(L) Length	mm (0.016 ± 0.0008)	0.60 ± 0.03 (0.024 ± 0.001)			1.00 ± 0.10 (0.040 ± 0.004)			1.60 ± 0.15 (0.063 ± 0.006)				2.01 ± 0.20 (0.079 ± 0.008)				3.20 ± 0.20 (0.126 ± 0.008)													
(W) Width	mm (0.008 ± 0.0008)	0.30 ± 0.03 (0.011 ± 0.001)			0.50 ± 0.10 (0.020 ± 0.004)			0.81 ± 0.15 (0.032 ± 0.006)				1.25 ± 0.20 (0.049 ± 0.008)				1.60 ± 0.20 (0.063 ± 0.008)													
(t) Terminal	mm (0.008 ± 0.0008)	0.15 ± 0.05 (0.006 ± 0.002)			0.25 ± 0.15 (0.010 ± 0.006)			0.35 ± 0.15 (0.014 ± 0.006)				0.50 ± 0.25 (0.020 ± 0.010)				0.50 ± 0.25 (0.020 ± 0.010)													
WWDC	10	10	16	25	16	25	50	6.3	10	16	25	50	100	200	6.3	10	16	25	50	100	200	6.3	10	16	25	50	100	200	500
Cap (pF)	100	A	A	A	A																								
	150	A	A	A	A																								
	220	A	A	A	A		C																						
	330	A	A	A	A		C					G	G	G	J	J	J	J	J	J	J								K
	470	A	A	A	A		C					G	G	G	J	J	J	J	J	J	J								K
	680	A	A	A	A		C					G	G	G	J	J	J	J	J	J	J								K
	1000	A	A	A			C					G	G	G	J	J	J	J	J	J	J								M
	1500		A				C					G	G	G	J	J	J	J	J	J	J		J	J	J	J	J	J	M
	2200		A				C					G	G	G	J	J	J	J	J	J	J		J	J	J	J	J	J	M
	3300		A				C					G	G	G	J	J	J	J	J	J	J		J	J	J	J	J	J	M
	4700		A				C					G	G	G	J	J	J	J	J	J	J		J	J	J	J	J	J	M
	6800		A				C					G	G	G	J	J	J	J	J	J	J		J	J	J	J	J	J	P
Cap (µF)	0.010		A				C					G	G	G	J	J	J	J	J	J	J		J	J	J	J	J	J	P
	0.015						C					G	G	G	J	J	J	J	J	J	J		J	J	J	J	J	J	M
	0.022						C					G	G	G	J	J	J	J	J	J	J		J	J	J	J	J	J	M
	0.033						C					G	G	G	J	J	J	J	J	N			J	J	J	J	J	M	
	0.047						C					G	G	G	J	J	J	J	J	N			J	J	J	J	J	M	
	0.068						C					G	G	G	J	J	J	J	J	N			J	J	J	J	J	P	
	0.10						C					G	G	G	J	J	J	J	J	N			J	J	J	J	M	P	
	0.15											G	G		J	J	J	J	N				J	J	J	J	Q		
	0.22											G			J	J	J	J	N				J	J	J	J	Q		
	0.33														N	N	N	N	N				J	J	M	P	Q	Q	
	0.47														N	N	N	N	N				M	M	M	P	Q	Q	
	0.68														N	N	N	N	N				M	M	Q	Q	Q	Q	
	1.0														N	N	N	N					M	M	Q	Q	Q		
	1.5																						P	Q	Q	Q			
	2.2																						Q	Q	Q		Q*		
	3.3																												
	4.7																												
	10																												
	22																												
	47																												
	100																												
WWDC	10	10	16	25	16	25	50	6.3	10	16	25	50	100	200	6.3	10	16	25	50	100	200	6.3	10	16	25	50	100	200	500

Letter	A	C	E	G	J	K	M	N	P	Q	X	Y	Z
Max. Thickness	0.33 (0.013)	0.56 (0.022)	0.71 (0.028)	0.90 (0.035)	0.94 (0.037)	1.02 (0.040)	1.27 (0.050)	1.40 (0.055)	1.52 (0.060)	1.78 (0.070)	2.29 (0.090)	2.54 (0.100)	2.79 (0.110)
	PAPER					EMBOSSSED							

\*Optional Specifications – Contact factory

# X7R Dielectric



## Capacitance Range

PREFERRED SIZES ARE SHADED

SIZE	1210							1812				1825		2220				2225		
	Reflow Only							Reflow Only				Reflow Only		Reflow Only				Reflow Only		
Soldering	Paper/Embossed							All Embossed				All Embossed		All Embossed				All Embossed		
Packaging	Paper/Embossed							All Embossed				All Embossed		All Embossed				All Embossed		
(L) Length (mm (in.))	3.20 ± 0.20 (0.126 ± 0.008)							4.50 ± 0.30 (0.177 ± 0.012)				4.50 ± 0.30 (0.177 ± 0.012)		5.70 ± 0.40 (0.225 ± 0.016)				5.72 ± 0.25 (0.225 ± 0.010)		
(W) Width (mm (in.))	2.50 ± 0.20 (0.098 ± 0.008)							3.20 ± 0.20 (0.126 ± 0.008)				6.40 ± 0.40 (0.252 ± 0.016)		5.00 ± 0.40 (0.197 ± 0.016)				6.35 ± 0.25 (0.250 ± 0.010)		
(t) Terminal (mm (in.))	0.50 ± 0.25 (0.020 ± 0.010)							0.61 ± 0.36 (0.024 ± 0.014)				0.61 ± 0.36 (0.024 ± 0.014)		0.64 ± 0.39 (0.025 ± 0.015)				0.64 ± 0.39 (0.025 ± 0.015)		
WVDC	10	16	25	50	100	200	500	50	100	200	500	50	100	25	50	100	200	50	100	
Cap (pF)	100																			
	150																			
	220																			
	330																			
	470																			
	680																			
	1000																			
	1500	J	J	J	J	J	J	M												
	2200	J	J	J	J	J	J	M												
	3300	J	J	J	J	J	J	M												
	4700	J	J	J	J	J	J	M												
	6800	J	J	J	J	J	J	M												
Cap (µF)	0.010	J	J	J	J	J	J	M	K	K	K	K	M	M		X	X	X	M	P
	0.015	J	J	J	J	J	J	M	K	K	K	P	M	M		X	X	X	M	P
	0.022	J	J	J	J	J	J	M	K	K	K	P	M	M		X	X	X	M	P
	0.033	J	J	J	J	J	J	Q	K	K	K	X	M	M		X	X	X	M	P
	0.047	J	J	J	J	J	J		K	K	K	Z	M	M		X	X	X	M	P
	0.068	J	J	J	J	J	M		K	K	K	Z	M	M		X	X	X	M	P
	0.10	J	J	J	J	J	M		K	K	K	Z	M	M		X	X	X	M	P
	0.15	J	J	J	J	M	Z		K	K	P		M	M		X	X	X	M	P
	0.22	J	J	J	J	P	Z		K	K	P		M	M		X	X	X	M	P
	0.33	J	J	J	J	Q			K	M	X		M	M		X	X	X	M	P
	0.47	M	M	M	M	Q			K	P			M	M		X	X	X	M	P
	0.68	M	M	P	X	X			M	Q			M	P		X	X		M	P
	1.0	N	N	P	X	Z			M	X			M	P		X	X		M	P
	1.5	N	N	Z	Z	Z			Z	Z			M			X	X		M	X
	2.2	X	X	Z	Z	Z			Z	Z						X	X		M	
	3.3	X	X	Z	Z				Z							X	Z			
	4.7	X	X	Z	Z				Z							X	Z			
	10	Z	Z	Z*												Z				
	22	Z*	Z*																	
	47																			
	100																			
WVDC	10	16	25	50	100	200	500	50	100	200	500	50	100	25	50	100	200	50	100	

Letter	A	C	E	G	J	K	M	N	P	Q	X	Y	Z
Max. Thickness	0.33 (0.013)	0.56 (0.022)	0.71 (0.028)	0.90 (0.035)	0.94 (0.037)	1.02 (0.040)	1.27 (0.050)	1.40 (0.055)	1.52 (0.060)	1.78 (0.070)	2.29 (0.090)	2.54 (0.100)	2.79 (0.110)
	PAPER					EMBOSSSED							

\*Optional Specifications – Contact factory

# X7S Dielectric



## General Specifications

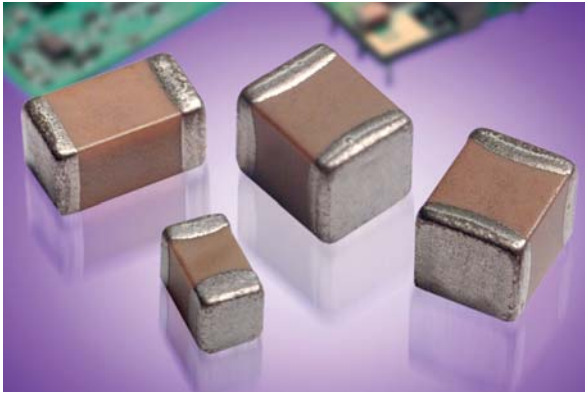

### GENERAL DESCRIPTION

X7S formulations are called “temperature stable” ceramics and fall into EIA Class II materials. Its temperature variation of capacitance is within  $\pm 22\%$  from  $-55^{\circ}\text{C}$  to  $+125^{\circ}\text{C}$ . This capacitance change is non-linear.

Capacitance for X7S varies under the influence of electrical operating conditions such as voltage and frequency.

X7S dielectric chip usage covers the broad spectrum of industrial applications where known changes in capacitance due to applied voltages are acceptable.

### PART NUMBER (see page 2 for complete part number explanation)

**1206**

**Size**  
(L" x W")

**Z**

**Voltage**  
4 = 4V  
6 = 6.3V  
Z = 10V  
Y = 16V  
3 = 25V  
5 = 50V  
1 = 100V  
2 = 200V

**Z**

**Dielectric**  
Z = X7S

**105**

**Capacitance Code (In pF)**  
2 Sig. Digits + Number of Zeros

**M**

**Capacitance Tolerance**  
K =  $\pm 10\%$   
M =  $\pm 20\%$

**A**

**Failure Rate**  
A = N/A

**T**

**Terminations**  
T = Plated Ni and Sn

**2**

**Packaging**  
2 = 7" Reel  
4 = 13" Reel  
7 = Bulk Cass.

**A**

**Special Code**  
A = Std. Product



NOTE: Contact factory for availability of Tolerance Options for Specific Part Numbers.

### TYPICAL ELECTRICAL CHARACTERISTICS

**X7S Dielectric Typical Temperature Coefficient**

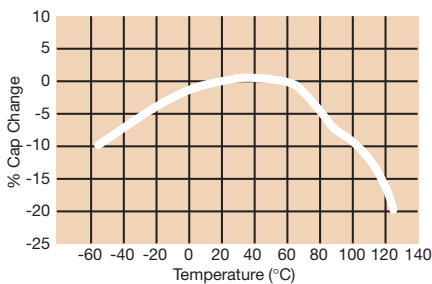

**$\Delta$  Capacitance vs. Frequency**

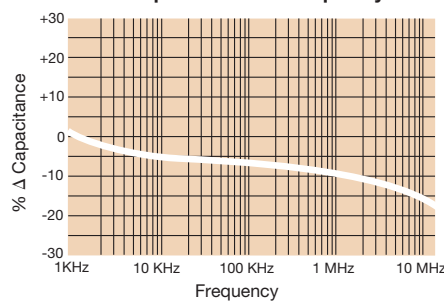

**Insulation Resistance vs Temperature**

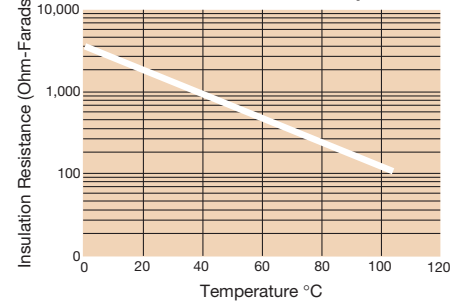

**Variation of Impedance with Cap Value Impedance vs. Frequency 1,000 pF vs. 10,000 pF - X7S 0805**

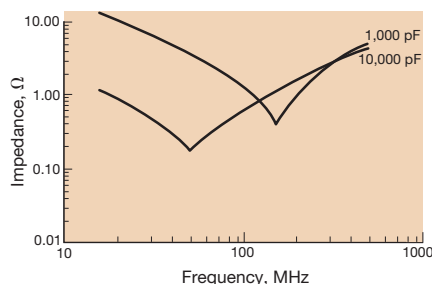

**Variation of Impedance with Chip Size Impedance vs. Frequency 10,000 pF - X7S**

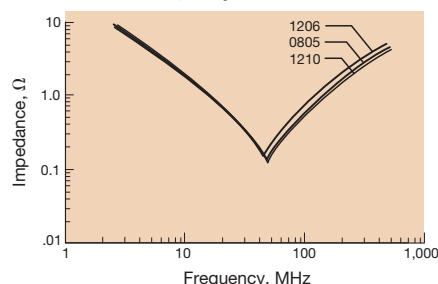

**Variation of Impedance with Chip Size Impedance vs. Frequency 100,000 pF - X7S**

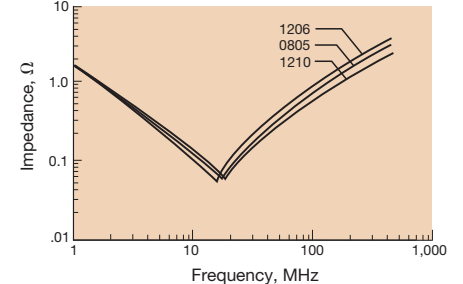

## Specifications and Test Methods

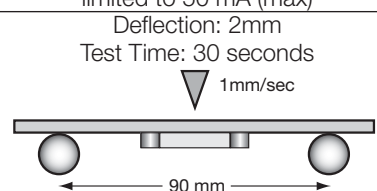
Parameter/Test		X7S Specification Limits	Measuring Conditions	
<b>Operating Temperature Range</b>		-55°C to +125°C	Temperature Cycle Chamber	
<b>Capacitance</b>		Within specified tolerance	Freq.: 1.0 kHz $\pm$ 10% Voltage: 1.0Vrms $\pm$ .2V For Cap > 10 $\mu$ F, 0.5Vrms @ 120Hz	
<b>Dissipation Factor</b>		$\leq$ 2.5% for $\geq$ 50V DC rating $\leq$ 3.0% for 25V DC rating $\leq$ 3.5% for 16V DC rating $\leq$ 5.0% for $\leq$ 10V DC rating		
<b>Insulation Resistance</b>		100,000M $\Omega$ or 1000M $\Omega$ - $\mu$ F, whichever is less	Charge device with rated voltage for 120 $\pm$ 5 secs @ room temp/humidity	
<b>Dielectric Strength</b>		No breakdown or visual defects	Charge device with 300% of rated voltage for 1-5 seconds, w/charge and discharge current limited to 50 mA (max)	
<b>Resistance to Flexure Stresses</b>	Appearance	No defects	Deflection: 2mm Test Time: 30 seconds 	
	Capacitance Variation	$\leq \pm 12\%$		
	Dissipation Factor	Meets Initial Values (As Above)		
	Insulation Resistance	$\geq$ Initial Value x 0.3		
<b>Solderability</b>		$\geq$ 95% of each terminal should be covered with fresh solder	Dip device in eutectic solder at 230 $\pm$ 5°C for 5.0 $\pm$ 0.5 seconds	
<b>Resistance to Solder Heat</b>	Appearance	No defects, <25% leaching of either end terminal	Dip device in eutectic solder at 260°C for 60 seconds. Store at room temperature for 24 $\pm$ 2 hours before measuring electrical properties.	
	Capacitance Variation	$\leq \pm 7.5\%$		
	Dissipation Factor	Meets Initial Values (As Above)		
	Insulation Resistance	Meets Initial Values (As Above)		
	Dielectric Strength	Meets Initial Values (As Above)		
<b>Thermal Shock</b>	Appearance	No visual defects	Step 1: -55°C $\pm$ 2°	30 $\pm$ 3 minutes
	Capacitance Variation	$\leq \pm 7.5\%$	Step 2: Room Temp	$\leq$ 3 minutes
	Dissipation Factor	Meets Initial Values (As Above)	Step 3: +125°C $\pm$ 2°	30 $\pm$ 3 minutes
	Insulation Resistance	Meets Initial Values (As Above)	Step 4: Room Temp	$\leq$ 3 minutes
	Dielectric Strength	Meets Initial Values (As Above)	Repeat for 5 cycles and measure after 24 $\pm$ 2 hours at room temperature	
<b>Load Life</b>	Appearance	No visual defects	Charge device with 1.5 rated voltage ( $\leq$ 10V) in test chamber set at 125°C $\pm$ 2°C for 1000 hours (+48, -0)  Remove from test chamber and stabilize at room temperature for 24 $\pm$ 2 hours before measuring.	
	Capacitance Variation	$\leq \pm 12.5\%$		
	Dissipation Factor	$\leq$ Initial Value x 2.0 (See Above)		
	Insulation Resistance	$\geq$ Initial Value x 0.3 (See Above)		
	Dielectric Strength	Meets Initial Values (As Above)		
<b>Load Humidity</b>	Appearance	No visual defects	Store in a test chamber set at 85°C $\pm$ 2°C/ 85% $\pm$ 5% relative humidity for 1000 hours (+48, -0) with rated voltage applied.  Remove from chamber and stabilize at room temperature and humidity for 24 $\pm$ 2 hours before measuring.	
	Capacitance Variation	$\leq \pm 12.5\%$		
	Dissipation Factor	$\leq$ Initial Value x 2.0 (See Above)		
	Insulation Resistance	$\geq$ Initial Value x 0.3 (See Above)		
	Dielectric Strength	Meets Initial Values (As Above)		

# X7S Dielectric

## Capacitance Range



PREFERRED SIZES ARE SHADED

SIZE	0402	0603	0805	1206	1210
<b>Soldering</b>	Reflow/Wave	Reflow/Wave	Reflow/Wave	Reflow/Wave	Reflow Only
<b>Packaging</b>	All Paper	All Paper	Paper/Embossed	Paper/Embossed	Paper/Embossed
(L) Length	mm (in.)	mm (in.)	mm (in.)	mm (in.)	mm (in.)
(W) Width	mm (in.)	mm (in.)	mm (in.)	mm (in.)	mm (in.)
(t) Terminal	mm (in.)	mm (in.)	mm (in.)	mm (in.)	mm (in.)
WVDC	6.3	6.3 25	4	6.3 10	6.3
Cap (pF)					
100					
150					
220					
330					
470					
680					
1000					
1500					
2200					
Cap (μF)					
0.010					
0.015					
0.022					
0.033	C				
0.047	C				
0.068	C				
0.10	C				
0.15					
0.22			G		
0.33		G			
0.47		G			
0.68		G			
1.0		G			
1.5			N	Q	
2.2			N	Q	
3.3			N	Q	
4.7			N	Q	Q
10					
22					Z
47					
100					
WVDC	6.3	6.3 25	4	6.3 10	6.3
<b>SIZE</b>	<b>0402</b>	<b>0603</b>	<b>0805</b>	<b>1206</b>	<b>1210</b>

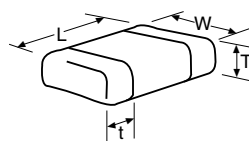

Letter	A	C	E	G	J	K	M	N	P	Q	X	Y	Z
<b>Max. Thickness</b>	0.33 (0.013)	0.56 (0.022)	0.71 (0.028)	0.90 (0.035)	0.94 (0.037)	1.02 (0.040)	1.27 (0.050)	1.40 (0.055)	1.52 (0.060)	1.78 (0.070)	2.29 (0.090)	2.54 (0.100)	2.79 (0.110)

PAPER

EMBOSSSED



# X5R Dielectric

## General Specifications

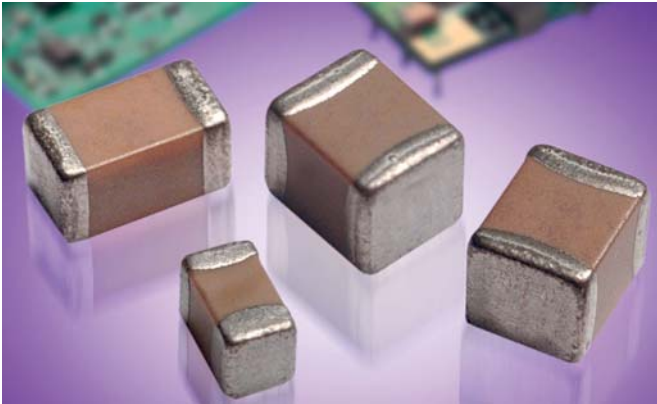

### GENERAL DESCRIPTION

- General Purpose Dielectric for Ceramic Capacitors
- EIA Class II Dielectric
- Temperature variation of capacitance is within  $\pm 15\%$  from  $-55^{\circ}\text{C}$  to  $+85^{\circ}\text{C}$
- Well suited for decoupling and filtering applications
- Available in High Capacitance values (up to  $100\mu\text{F}$ )

### PART NUMBER (see page 2 for complete part number explanation)

**1210**

**Size**  
(L" x W")

**4**

**Voltage**  
4 = 4V  
6 = 6.3V  
Z = 10V  
Y = 16V  
3 = 25V  
D = 35V  
5 = 50V

**D**

**Dielectric**  
D = X5R

**107**

**Capacitance Code (In pF)**  
2 Sig. Digits +  
Number of  
Zeros

**M**

**Capacitance Tolerance**  
K =  $\pm 10\%$   
M =  $\pm 20\%$

**A**

**Failure Rate**  
A = N/A

**T**

**Terminations**  
T = Plated Ni  
and Sn

**2**

**Packaging**  
2 = 7" Reel  
4 = 13" Reel  
7 = Bulk Cass.  
9 = Bulk  
U = 4mm TR  
(01005)

**A**

**Special Code**  
A = Std.



NOTE: Contact factory for availability of Tolerance Options for Specific Part Numbers.  
Contact factory for non-specified capacitance values.

### TYPICAL ELECTRICAL CHARACTERISTICS

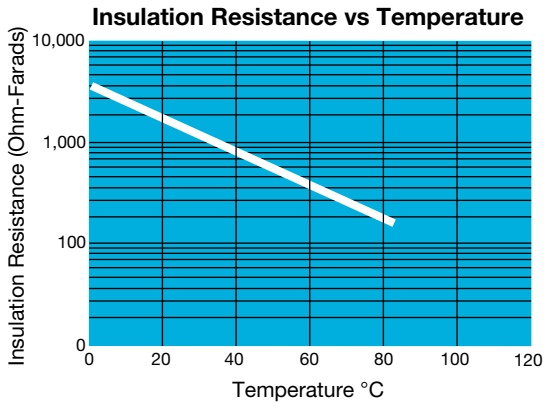
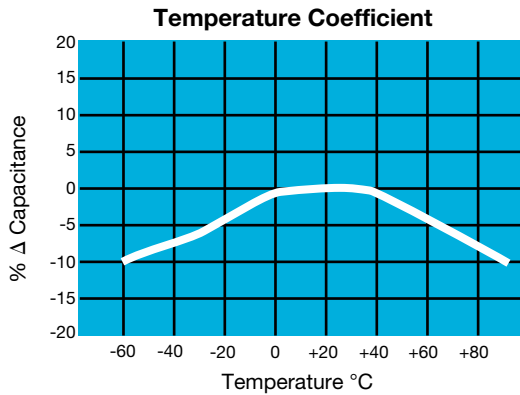

# X5R Dielectric

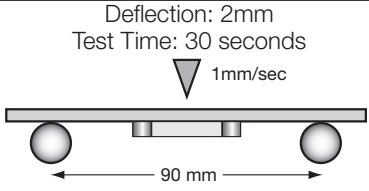

## Specifications and Test Methods

Parameter/Test		X5R Specification Limits	Measuring Conditions	
<b>Operating Temperature Range</b>		-55°C to +85°C	Temperature Cycle Chamber	
<b>Capacitance</b>		Within specified tolerance	Freq.: 1.0 kHz $\pm$ 10% Voltage: 1.0Vrms $\pm$ .2V For Cap > 10 $\mu$ F, 0.5Vrms @ 120Hz	
<b>Dissipation Factor</b>		$\leq$ 2.5% for $\geq$ 50V DC rating $\leq$ 3.0% for 25V DC rating $\leq$ 12.5% Max. for 16V DC rating and lower Contact Factory for DF by PN		
<b>Insulation Resistance</b>		10,000M $\Omega$ or 500M $\Omega$ - $\mu$ F, whichever is less	Charge device with rated voltage for 120 $\pm$ 5 secs @ room temp/humidity	
<b>Dielectric Strength</b>		No breakdown or visual defects	Charge device with 300% of rated voltage for 1-5 seconds, w/charge and discharge current limited to 50 mA (max)	
<b>Resistance to Flexure Stresses</b>	Appearance	No defects	Deflection: 2mm Test Time: 30 seconds 	
	Capacitance Variation	$\leq$ $\pm$ 12%		
	Dissipation Factor	Meets Initial Values (As Above)		
	Insulation Resistance	$\geq$ Initial Value x 0.3		
<b>Solderability</b>		$\geq$ 95% of each terminal should be covered with fresh solder	Dip device in eutectic solder at 230 $\pm$ 5°C for 5.0 $\pm$ 0.5 seconds	
<b>Resistance to Solder Heat</b>	Appearance	No defects, <25% leaching of either end terminal	Dip device in eutectic solder at 260°C for 60 seconds. Store at room temperature for 24 $\pm$ 2 hours before measuring electrical properties.	
	Capacitance Variation	$\leq$ $\pm$ 7.5%		
	Dissipation Factor	Meets Initial Values (As Above)		
	Insulation Resistance	Meets Initial Values (As Above)		
	Dielectric Strength	Meets Initial Values (As Above)		
<b>Thermal Shock</b>	Appearance	No visual defects	Step 1: -55°C $\pm$ 2°	30 $\pm$ 3 minutes
	Capacitance Variation	$\leq$ $\pm$ 7.5%	Step 2: Room Temp	$\leq$ 3 minutes
	Dissipation Factor	Meets Initial Values (As Above)	Step 3: +85°C $\pm$ 2°	30 $\pm$ 3 minutes
	Insulation Resistance	Meets Initial Values (As Above)	Step 4: Room Temp	$\leq$ 3 minutes
	Dielectric Strength	Meets Initial Values (As Above)	Repeat for 5 cycles and measure after 24 $\pm$ 2 hours at room temperature	
	<b>Load Life</b>		No visual defects	Charge device with 1.5X rated voltage in test chamber set at 85°C $\pm$ 2°C for 1000 hours (+48, -0). Note: Contact factory for *optional specification part numbers that are tested at < 1.5X rated voltage.
<b>Load Humidity</b>	Capacitance Variation	$\leq$ $\pm$ 12.5%	Remove from test chamber and stabilize at room temperature for 24 $\pm$ 2 hours before measuring.	
	Dissipation Factor	$\leq$ Initial Value x 2.0 (See Above)		
	Insulation Resistance	$\geq$ Initial Value x 0.3 (See Above)		
	Dielectric Strength	Meets Initial Values (As Above)		
	Appearance	No visual defects		
<b>Load Humidity</b>	Capacitance Variation	$\leq$ $\pm$ 12.5%	Store in a test chamber set at 85°C $\pm$ 2°C/ 85% $\pm$ 5% relative humidity for 1000 hours (+48, -0) with rated voltage applied.	
	Dissipation Factor	$\leq$ Initial Value x 2.0 (See Above)		
	Insulation Resistance	$\geq$ Initial Value x 0.3 (See Above)		
	Dielectric Strength	Meets Initial Values (As Above)		
	Appearance	No visual defects		
<b>Load Humidity</b>		No visual defects	Remove from chamber and stabilize at room temperature and humidity for 24 $\pm$ 2 hours before measuring.	
<b>Load Humidity</b>	Capacitance Variation	$\leq$ $\pm$ 12.5%	Store in a test chamber set at 85°C $\pm$ 2°C/ 85% $\pm$ 5% relative humidity for 1000 hours (+48, -0) with rated voltage applied.	
	Dissipation Factor	$\leq$ Initial Value x 2.0 (See Above)		
	Insulation Resistance	$\geq$ Initial Value x 0.3 (See Above)		
	Dielectric Strength	Meets Initial Values (As Above)		
	Appearance	No visual defects		

# X5R Dielectric

## Capacitance Range



PREFERRED SIZES ARE SHADED

SIZE	0101*	0201	0402	0603	0805	1206	1210	1812
Soldering	Reflow Only	Reflow Only	Reflow/Wave	Reflow/Wave	Reflow/Wave	Reflow/Wave	Reflow Only	Reflow Only
Packaging	Paper/Embossed	All Paper	All Paper	All Paper	Paper/Embossed	Paper/Embossed	Paper/Embossed	All Embossed
(L) Length	mm (in.)	0.40 ± 0.02 (0.016 ± 0.0008)	0.60 ± 0.03 (0.024 ± 0.001)	1.00 ± 0.10 (0.040 ± 0.004)	1.60 ± 0.15 (0.063 ± 0.006)	2.01 ± 0.20 (0.079 ± 0.008)	3.20 ± 0.20 (0.126 ± 0.008)	4.50 ± 0.30 (0.177 ± 0.012)
(W) Width	mm (in.)	0.20 ± 0.02 (0.008 ± 0.0008)	0.30 ± 0.03 (0.011 ± 0.001)	0.50 ± 0.10 (0.020 ± 0.004)	0.81 ± 0.15 (0.032 ± 0.006)	1.25 ± 0.20 (0.049 ± 0.008)	1.60 ± 0.20 (0.063 ± 0.008)	3.20 ± 0.20 (0.126 ± 0.008)
(t) Terminal	mm (in.)	0.10 ± 0.04 (0.004 ± 0.016)	0.15 ± 0.05 (0.006 ± 0.002)	0.25 ± 0.15 (0.010 ± 0.006)	0.35 ± 0.15 (0.014 ± 0.006)	0.50 ± 0.25 (0.020 ± 0.010)	0.50 ± 0.25 (0.020 ± 0.010)	0.61 ± 0.36 (0.024 ± 0.014)
WVDC	6.3 10	4 6.3 10 16 25	4 6.3 10 16 25 50	4 6.3 10 16 25 35 50	6.3 10 16 25 35 50	6.3 10 16 25 35 50	6.3 10 16 25 35 50 100	4 6.3 10 16 25 35 50
Cap (pF)	100	B	A	C				
	150	B	A					
	220	B	A					
	330	B	A	C				
	470	B	A	C				
	680	B	A	C				
	1000	B	A	C				
	1500	B	A	C				
	2200	B	A	C				
	3300	B	A	C				
	4700	B	A	C				
	6800	B	A	C				
Cap (µF)	0.010	B	A	C				
	0.015	B		C	G			
	0.022	B	A*	C	G			
	0.033	B		C	G			
	0.047	B	A*	C	G			
	0.068	B		C	G			
	0.10	B	A*	C	G			
	0.15							
	0.22		A* A*	C* C* C*	G			
	0.33				G			
	0.47		A* A*	C* C* C* C*	G			
	0.68				G			
	1.0		A* A*	C* C* C* C*	G G G J*			
	1.5							
	2.2		A* A*	C* C* C*	G* G* J* J*			
	3.3							
	4.7			E* E*	J* J* J* J*			
	10				K J* J*			
	22				K			
	47							
	100							
WVDC	6.3 10	4 6.3 10 16 25	4 6.3 10 16 25 50	4 6.3 10 16 25 35 50	6.3 10 16 25 35 50	6.3 10 16 25 35 50	6.3 10 16 25 35 50 100	4 6.3 10 16 25 35 50

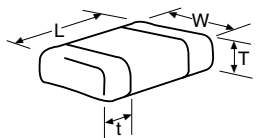

Letter	A	B	C	E	G	J	K	M	N	P	Q	X	Y	Z
Max. Thickness	0.33 (0.013)	0.22 (0.009)	0.56 (0.022)	0.71 (0.028)	0.90 (0.035)	0.94 (0.037)	1.02 (0.040)	1.27 (0.050)	1.40 (0.055)	1.52 (0.060)	1.78 (0.070)	2.29 (0.090)	2.54 (0.100)	2.79 (0.110)
	PAPER						EMBOSED							

- = Under Development
- = \*Optional Specifications – Contact factory

NOTE: Contact factory for non-specified capacitance values

\*EIA 01005



# Y5V Dielectric

## General Specifications

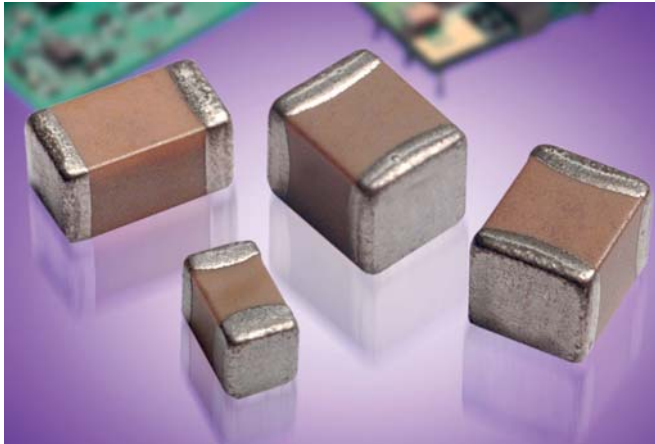

Y5V formulations are for general-purpose use in a limited temperature range. They have a wide temperature characteristic of +22% -82% capacitance change over the operating temperature range of -30°C to +85°C.

These characteristics make Y5V ideal for decoupling applications within limited temperature range.



### PART NUMBER (see page 2 for complete part number explanation)

**0805**

**Size**  
(L" x W")

**3**

**Voltage**  
6.3V = 6  
10V = Z  
16V = Y  
25V = 3  
50V = 5

**G**

**Dielectric**  
Y5V = G

**104**

**Capacitance Code (In pF)**  
2 Sig. Digits + Number of Zeros

**Z**

**Capacitance Tolerance**  
Z = +80 -20%

**A**

**Failure Rate**  
A = Not Applicable

**T**

**Terminations**  
T = Plated Ni and Sn

**2**

**Packaging**  
2 = 7" Reel  
4 = 13" Reel

**A**

**Special Code**  
A = Std. Product

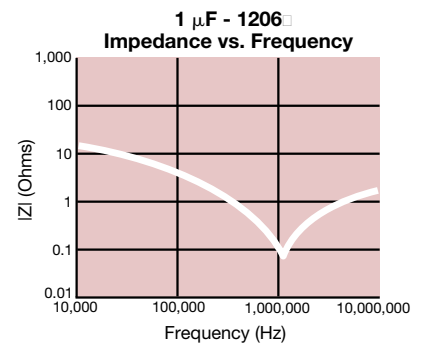
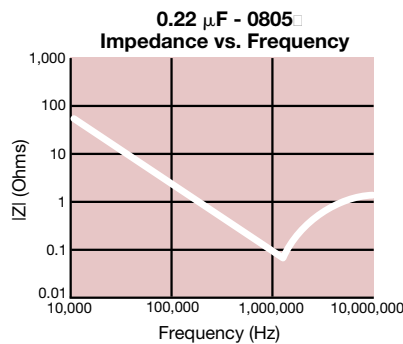
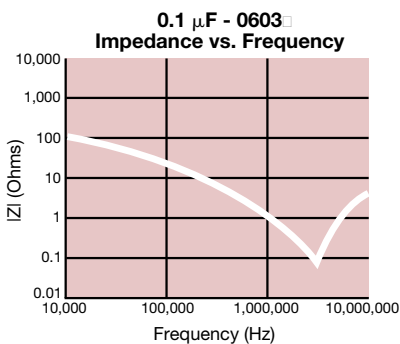
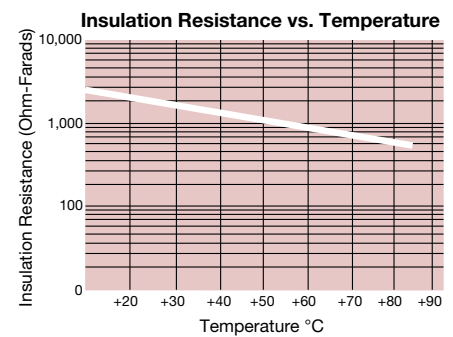
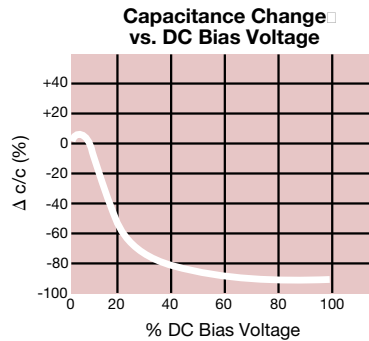
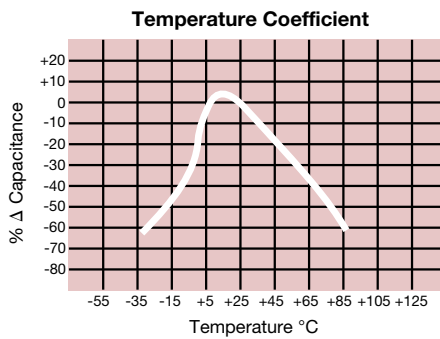

## Specifications and Test Methods

Parameter/Test		Y5V Specification Limits	Measuring Conditions	
<b>Operating Temperature Range</b>		-30°C to +85°C	Temperature Cycle Chamber	
<b>Capacitance</b>		Within specified tolerance	Freq.: 1.0 kHz ± 10% Voltage: 1.0Vrms ± .2V For Cap > 10 µF, 0.5Vrms @ 120Hz	
<b>Dissipation Factor</b>		≤ 5.0% for ≥ 50V DC rating ≤ 7.0% for 25V DC rating ≤ 9.0% for 16V DC rating ≤ 12.5% for ≤ 10V DC rating		
<b>Insulation Resistance</b>		10,000MΩ or 500MΩ - µF, whichever is less	Charge device with rated voltage for 120 ± 5 secs @ room temp/humidity	
<b>Dielectric Strength</b>		No breakdown or visual defects	Charge device with 300% of rated voltage for 1-5 seconds, w/charge and discharge current limited to 50 mA (max)	
<b>Resistance to Flexure Stresses</b>	Appearance	No defects	Deflection: 2mm Test Time: 30 seconds 1mm/sec 90 mm	
	Capacitance Variation	≤ ±30%		
	Dissipation Factor	Meets Initial Values (As Above)		
	Insulation Resistance	≥ Initial Value x 0.1		
<b>Solderability</b>		≥ 95% of each terminal should be covered with fresh solder	Dip device in eutectic solder at 230 ± 5°C for 5.0 ± 0.5 seconds	
<b>Resistance to Solder Heat</b>	Appearance	No defects, <25% leaching of either end terminal	Dip device in eutectic solder at 260°C for 60 seconds. Store at room temperature for 24 ± 2 hours before measuring electrical properties.	
	Capacitance Variation	≤ ±20%		
	Dissipation Factor	Meets Initial Values (As Above)		
	Insulation Resistance	Meets Initial Values (As Above)		
	Dielectric Strength	Meets Initial Values (As Above)		
<b>Thermal Shock</b>	Appearance	No visual defects	Step 1: -30°C ± 2°	30 ± 3 minutes
	Capacitance Variation	≤ ±20%	Step 2: Room Temp	≤ 3 minutes
	Dissipation Factor	Meets Initial Values (As Above)	Step 3: +85°C ± 2°	30 ± 3 minutes
	Insulation Resistance	Meets Initial Values (As Above)	Step 4: Room Temp	≤ 3 minutes
	Dielectric Strength	Meets Initial Values (As Above)	Repeat for 5 cycles and measure after 24 ± 2 hours at room temperature	
	<b>Load Life</b>		Meets Initial Values (As Above)	Charge device with twice rated voltage in test chamber set at 85°C ± 2°C for 1000 hours (+48, -0)  Remove from test chamber and stabilize at room temperature for 24 ± 2 hours before measuring.
<b>Load Humidity</b>	Appearance	No visual defects	Store in a test chamber set at 85°C ± 2°C/ 85% ± 5% relative humidity for 1000 hours (+48, -0) with rated voltage applied.  Remove from chamber and stabilize at room temperature and humidity for 24 ± 2 hours before measuring.	
	Capacitance Variation	≤ ±30%		
	Dissipation Factor	≤ Initial Value x 1.5 (See above)		
	Insulation Resistance	≥ Initial Value x 0.1 (See Above)		
	Dielectric Strength	Meets Initial Values (As Above)		

# Y5V Dielectric

## Capacitance Range



PREFERRED SIZES ARE SHADED

SIZE		0201		0402				0603				0805				1206				1210					
Soldering		Reflow Only		Reflow/Wave				Reflow/Wave				Reflow/Wave				Reflow/Wave				Reflow Only					
Packaging		All Paper		All Paper				All Paper				Paper/Embossed				Paper/Embossed				Paper/Embossed					
(L) Length	mm	0.60 ± 0.03		1.00 ± 0.10				1.60 ± 0.15				2.01 ± 0.20				3.20 ± 0.20				3.20 ± 0.20					
	(in.)	(0.024 ± 0.001)		(0.040 ± 0.004)				(0.063 ± 0.006)				(0.079 ± 0.008)				(0.126 ± 0.008)				(0.126 ± 0.008)					
(W) Width	mm	0.30 ± 0.03		0.50 ± 0.10				.81 ± 0.15				1.25 ± 0.20				1.60 ± 0.20				2.50 ± 0.20					
	(in.)	(0.011 ± 0.001)		(0.020 ± 0.004)				(0.032 ± 0.006)				(0.049 ± 0.008)				(0.063 ± 0.008)				(0.098 ± 0.008)					
(t) Terminal	mm	0.15 ± 0.05		0.25 ± 0.15				0.35 ± 0.15				0.50 ± 0.25				0.50 ± 0.25				.50 ± 0.25					
	(in.)	(0.006 ± 0.002)		(0.010 ± 0.006)				(0.014 ± 0.006)				(0.020 ± 0.010)				(0.020 ± 0.010)				(0.020 ± 0.010)					
WVDC		6.3	10	6	10	16	25	50	10	16	25	50	10	16	25	50	10	16	25	50	10	16	25	50	
Cap (pF)	820																								
	1000		A																						
	2200		A																						
Cap (µF)	4700		A																						
	0.010	A	A																						
	0.022	A	A																						
	0.047	A																							
	0.10				C																				
	0.22					C																			
	0.33																								
	0.47																								
	1.0				C																				
	2.2																								
	4.7																								
	10.0																								
	22.0																								
	47.0																								
WVDC		6.3	10	6	10	16	25	50	10	16	25	50	10	16	25	50	10	16	25	50	10	16	25	50	

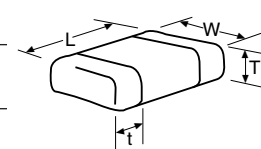

Letter	A	C	E	G	J	K	M	N	P	Q	X	Y	Z
Max. Thickness	0.33 (0.013)	0.56 (0.022)	0.71 (0.028)	0.90 (0.035)	0.94 (0.037)	1.02 (0.040)	1.27 (0.050)	1.40 (0.055)	1.52 (0.060)	1.78 (0.070)	2.29 (0.090)	2.54 (0.100)	2.79 (0.110)
	PAPER					EMBOSSSED							

# MLCC Gold Termination – AU Series



## General Specifications

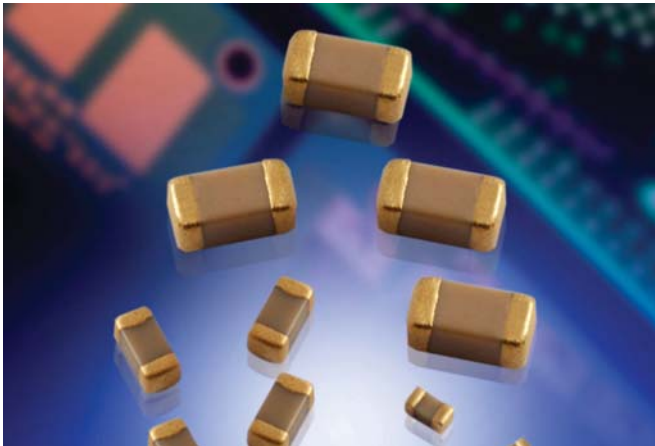

AVX Corporation will support those customers for commercial and military Multilayer Ceramic Capacitors with a termination consisting of Gold. This termination is indicated by the use of a “7” or “G” in the 12th position of the AVX Catalog Part Number. This fulfills AVX’s commitment to providing a full range of products to our customers. Please contact the factory if you require additional information on our MLCC Gold Termination.



## PART NUMBER

AU03	Y	C	104	K	A	7	2	A
<b>Size</b>	<b>Voltage</b>	<b>Dielectric</b>	<b>Capacitance Code (In pF)</b>	<b>Capacitance Tolerance</b>	<b>Failure Rate</b>	<b>Terminations</b>	<b>Packaging</b>	<b>Special Code</b>
AU01 - 0201 AU02 - 0402 AU03 - 0603 AU05 - 0805 AU06 - 1206 AU10 - 1210 AU12 - 1812 AU13 - 1825 AU14 - 2225 AU16 - 0306 AU17 - 0508 AU18 - 0612	6.3V = 6 10V = Z 16V = Y 25V = 3 35V = D 50V = 5 100V = 1 200V = 2 500V = 7	COG (NP0) = A X7R = C X5R = D	2 Sig. Digits + Number of Zeros	B = ±.10 pF (<10pF) C = ±.25 pF (<10pF) D = ±.50 pF (<10pF) F = ±1% (≥ 10 pF) G = ±2% (≥ 10 pF) J = ±5% K = ±10% M = ±20%	A = Not Applicable	G* = 1.9 μ" to 7.87 μ"  7 = 100 μ" minimum	2 = 7" Reel 4 = 13" Reel 9 = Bulk U = 4mm TR (01005)  <b>Contact Factory For Multiples*</b>	A = Std. Product

\* Contact factory for availability.

# MLCC Gold Termination – AU Series



## Capacitance Range (NP0 Dielectric)

PREFERRED SIZES ARE SHADED

SIZE	AU01		AU02			AU03				AU05					AU06						
Soldering	Reflow/Epoxy/Wire Bond*		Reflow/Epoxy/Wire Bond*			Reflow/Epoxy/Wire Bond				Reflow/Epoxy/Wire Bond					Reflow/Epoxy/Wire Bond						
Packaging	All Paper		All Paper			All Paper				Paper/Embossed					Paper/Embossed						
(L) Length	mm (in.)		mm (in.)			mm (in.)				mm (in.)					mm (in.)						
(W) Width	mm (in.)		mm (in.)			mm (in.)				mm (in.)					mm (in.)						
(t) Terminal	mm (in.)		mm (in.)			mm (in.)				mm (in.)					mm (in.)						
WVDC	16	25	16	25	50	16	25	50	100	16	25	50	100	200	16	25	50	100	200	500	
Cap (pF)	0.5	A	A	C	C	C	G	G	G	G	J	J	J	J	J	J	J	J	J	J	J
	1.0	A	A	C	C	C	G	G	G	G	J	J	J	J	J	J	J	J	J	J	J
	1.2	A	A	C	C	C	G	G	G	G	J	J	J	J	J	J	J	J	J	J	J
	1.5	A	A	C	C	C	G	G	G	G	J	J	J	J	J	J	J	J	J	J	J
	1.8	A	A	C	C	C	G	G	G	G	J	J	J	J	J	J	J	J	J	J	J
	2.2	A	A	C	C	C	G	G	G	G	J	J	J	J	J	J	J	J	J	J	J
	2.7	A	A	C	C	C	G	G	G	G	J	J	J	J	J	J	J	J	J	J	J
	3.3	A	A	C	C	C	G	G	G	G	J	J	J	J	J	J	J	J	J	J	J
	3.9	A	A	C	C	C	G	G	G	G	J	J	J	J	J	J	J	J	J	J	J
	4.7	A	A	C	C	C	G	G	G	G	J	J	J	J	J	J	J	J	J	J	J
	5.6	A	A	C	C	C	G	G	G	G	J	J	J	J	J	J	J	J	J	J	J
	6.8	A	A	C	C	C	G	G	G	G	J	J	J	J	J	J	J	J	J	J	J
	8.2	A	A	C	C	C	G	G	G	G	J	J	J	J	J	J	J	J	J	J	J
	10	A	A	C	C	C	G	G	G	G	J	J	J	J	J	J	J	J	J	J	J
	12	A	A	C	C	C	G	G	G	G	J	J	J	J	J	J	J	J	J	J	J
	15	A	A	C	C	C	G	G	G	G	J	J	J	J	J	J	J	J	J	J	J
	18	A	A	C	C	C	G	G	G	G	J	J	J	J	J	J	J	J	J	J	J
	22	A	A	C	C	C	G	G	G	G	J	J	J	J	J	J	J	J	J	J	J
	27	A	A	C	C	C	G	G	G	G	J	J	J	J	J	J	J	J	J	J	J
	33	A	A	C	C	C	G	G	G	G	J	J	J	J	J	J	J	J	J	J	J
	39	A	A	C	C	C	G	G	G	G	J	J	J	J	J	J	J	J	J	J	J
	47	A	A	C	C	C	G	G	G	G	J	J	J	J	J	J	J	J	J	J	J
	56	A	A	C	C	C	G	G	G	G	J	J	J	J	J	J	J	J	J	J	J
	68	A	A	C	C	C	G	G	G	G	J	J	J	J	J	J	J	J	J	J	J
	82	A	A	C	C	C	G	G	G	G	J	J	J	J	J	J	J	J	J	J	J
	100	A	A	C	C	C	G	G	G	G	J	J	J	J	J	J	J	J	J	J	J
	120			C	C	C	G	G	G	G	J	J	J	J	J	J	J	J	J	J	J
	150			C	C	C	G	G	G	G	J	J	J	J	J	J	J	J	J	J	J
	180			C	C	C	G	G	G	G	J	J	J	J	J	J	J	J	J	J	J
	220			C	C	C	G	G	G	G	J	J	J	J	J	J	J	J	J	J	M
	270			C	C	C	G	G	G	G	J	J	J	J	M	J	J	J	J	J	M
	330			C	C	C	G	G	G	G	J	J	J	J	M	J	J	J	J	J	M
	390			C	C	C	G	G	G		J	J	J	J	M	J	J	J	J	J	M
	470			C	C	C	G	G	G		J	J	J	J	M	J	J	J	J	J	M
	560						G	G	G		J	J	J	J	M	J	J	J	J	J	M
	680						G	G	G		J	J	J	J		J	J	J	J	J	P
	820						G	G	G		J	J	J	J		J	J	J	J	J	
	1000						G	G	G		J	J	J	J		J	J	J	J	J	Q
	1200										J	J	J			J	J	J	J	J	Q
	1500										J	J	J			J	J	J	J	J	Q
	1800										J	J	J			J	J	M	M		
	2200										J	J	N			J	J	M	P		
	2700										J	J	N			J	J	M	P		
	3300										J	J				J	J	M	P		
	3900										J	J				J	J	M	P		
	4700										J	J				J	J	M	P		
	5600															J	J	M			
	6800															M	M				
	8200															M	M				
Cap (µF)	0.010															M	M				
	0.012																				
	0.015																				
	0.018																				
	0.022																				
	0.027																				
	0.033																				
	0.039																				
	0.047																				
	0.068																				
	0.082																				
	0.1																				
WVDC	16	25	16	25	50	16	25	50	100	16	25	50	100	200	16	25	50	100	200	500	
SIZE	AU01		AU02			AU03				AU05					AU06						

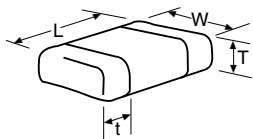

\* Contact factory

Letter	A	C	E	G	J	K	M	N	P	Q	X	Y	Z
Max. Thickness	0.33 (0.013)	0.56 (0.022)	0.71 (0.028)	0.90 (0.035)	0.94 (0.037)	1.02 (0.040)	1.27 (0.050)	1.40 (0.055)	1.52 (0.060)	1.78 (0.070)	2.29 (0.090)	2.54 (0.100)	2.79 (0.110)
	PAPER					EMBOSSED							





# MLCC Gold Termination – AU Series



## Capacitance Range (NP0 Dielectric)

PREFERRED SIZES ARE SHADED

SIZE		AU10					AU12					AU13			AU14		
Soldering		Reflow/Epoxy/ Wire Bond*					Reflow/Epoxy/ Wire Bond*					Reflow/Epoxy/ Wire Bond*			Reflow/Epoxy/ Wire Bond*		
Packaging		Paper/Embossed					All Embossed					All Embossed			All Embossed		
(L) Length	mm (in.)	3.20 ± 0.20 (0.126 ± 0.008)					4.50 ± 0.30 (0.177 ± 0.012)					4.50 ± 0.30 (0.177 ± 0.012)			5.72 ± 0.25 (0.225 ± 0.010)		
(W) Width	mm (in.)	2.50 ± 0.20 (0.098 ± 0.008)					3.20 ± 0.20 (0.126 ± 0.008)					6.40 ± 0.40 (0.252 ± 0.016)			6.35 ± 0.25 (0.250 ± 0.010)		
(t) Terminal	mm (in.)	0.50 ± 0.25 (0.020 ± 0.010)					0.61 ± 0.36 (0.024 ± 0.014)					0.61 ± 0.36 (0.024 ± 0.014)			0.64 ± 0.39 (0.025 ± 0.015)		
WDC		25	50	100	200	500	25	50	100	200	500	50	100	200	50	100	200
Cap (pF)	0.5																
	1.0																
	1.2																
	1.5																
	1.8																
	2.2																
	2.7																
	3.3																
	3.9																
	4.7																
	5.6																
	6.8																
	8.2																
	10					J											
	12					J											
	15					J											
	18					J											
	22					J											
	27					J											
	33					J											
	39					J											
	47					J											
	56					J											
	68					J											
	82					J											
	100					J											
	120					J											
	150					J											
	180					J											
	220					J											
	270					J											
	330					J											
	390					M											
	470					M											
	560	J	J	J	J	M											
	680	J	J	J	J	M											
	820	J	J	J	J	M											
	1000	J	J	J	J	M	K	K	K	K	M	M	M	M	M	M	P
	1200	J	J	J	J	M	K	K	K	K	M	M	M	M	M	M	P
	1500	J	J	J	M	M	K	K	K	K	M	M	M	M	M	M	P
	1800	J	J	J	M		K	K	K	K	M	M	M	M	M	M	P
	2200	J	J	J	Q		K	K	K	K	P	M	M	M	M	M	P
	2700	J	J	J	Q		K	K	K	P	Q	M	M	M	M	M	P
	3300	J	J	J			K	K	K	P	Q	M	M	M	M	M	P
	3900	J	J	M			K	K	K	P	Q	M	M	M	M	M	P
	4700	J	J	M			K	K	K	P	Q	M	M	M	M	M	P
	5600	J	J				K	K	M	P	X	M	M	M	M	M	P
	6800	J	J				K	K	M		X	M	M	M	M	M	P
	8200	J	J				K	M	M			M	M		M	M	P
Cap (µF)	0.010	J	J				K	M	M			M	M		M	M	P
	0.012	J	J				K	M				M	M		M	M	P
	0.015						M	M				M	M		M	M	Y
	0.018						M	M				P	M		M	M	Y
	0.022						M	M				P			M	Y	Y
	0.027						M	M				P			P	Y	Y
	0.033						M	M				P			P		
	0.039						M	M				P			P		
	0.047						M	M				P			P		
	0.068						M	M							P		
	0.082						M	M							Q		
	0.1						M	M							Q		
WDC		25	50	100	200	500	25	50	100	200	500	50	100	200	50	100	200

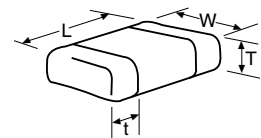

\* Contact factory

Letter	A	C	E	G	J	K	M	N	P	Q	X	Y	Z
Max. Thickness	0.33 (0.013)	0.56 (0.022)	0.71 (0.028)	0.90 (0.035)	0.94 (0.037)	1.02 (0.040)	1.27 (0.050)	1.40 (0.055)	1.52 (0.060)	1.78 (0.070)	2.29 (0.090)	2.54 (0.100)	2.79 (0.110)
	PAPER					EMBOSSSED							



# MLCC Gold Termination – AU Series



## Capacitance Range (X7R Dielectric)

PREFERRED SIZES ARE SHADED

SIZE	AU02			AU03						AU05						AU06										
Soldering	Reflow/Epoxy Wire Bond*			Reflow/Epoxy Wire Bond*						Reflow/Epoxy Wire Bond*						Reflow/Epoxy Wire Bond*										
Packaging	All Paper			All Paper						Paper/Embossed						Paper/Embossed										
(L) Length	mm	1.00 ± 0.10 (0.040 ± 0.004)		1.60 ± 0.15 (0.063 ± 0.006)						2.01 ± 0.20 (0.079 ± 0.008)						3.20 ± 0.20 (0.126 ± 0.008)										
(W) Width	mm	0.50 ± 0.10 (0.020 ± 0.004)		0.81 ± 0.15 (0.032 ± 0.006)						1.25 ± 0.20 (0.049 ± 0.008)						1.60 ± 0.20 (0.063 ± 0.008)										
(t) Terminal	mm	0.25 ± 0.15 (0.010 ± 0.006)		0.35 ± 0.15 (0.014 ± 0.006)						0.50 ± 0.25 (0.020 ± 0.010)						0.50 ± 0.25 (0.020 ± 0.010)										
WVDC		16	25	50	6.3	10	16	25	50	100	200	6.3	10	16	25	50	100	200	6.3	10	16	25	50	100	200	500
Cap (pF)	100																									
	150																									
	220			C																						
	330			C					G	G	G		J	J	J	J	J	J								K
	470			C					G	G	G		J	J	J	J	J	J								K
	680			C					G	G	G		J	J	J	J	J	J								K
	1000			C					G	G	G		J	J	J	J	J	J								K
	1500			C					G	G	G		J	J	J	J	J	J		J	J	J	J	J	J	M
	2200			C					G	G	G		J	J	J	J	J	J		J	J	J	J	J	J	M
	3300			C					G	G	G		J	J	J	J	J	J		J	J	J	J	J	J	M
	4700			C					G	G	G		J	J	J	J	J	J		J	J	J	J	J	J	M
	6800	C	C	C					G	G	G		J	J	J	J	J	J		J	J	J	J	J	J	P
Cap (µF)	0.010	C	C	C					G	G	G		J	J	J	J	J	J		J	J	J	J	J	J	P
	0.015	C	C	C					G	G	G		J	J	J	J	J	J		J	J	J	J	J	J	M
	0.022	C	C	C					G	G	G		J	J	J	J	J	J	N		J	J	J	J	J	M
	0.033								G	G	G		J	J	J	J	J	N		J	J	J	J	J	J	M
	0.047						G	G	G	G	G		J	J	J	J	J	N		J	J	J	J	J	J	M
	0.068						G	G	G	G	G		J	J	J	J	J	N		J	J	J	J	J	J	P
	0.10		C*				G	G	G	G	G		J	J	J	J	N		J	J	J	J	J	M	P	
	0.15					G	G	G					J	J	J	J	N		J	J	J	J	J	Q		
	0.22					G	G	G					J	J	J	N	N		J	J	J	J	J	Q		
	0.33												N	N	N	N	N		J	J	M	P	Q	Q		
	0.47							J*					N	N	N	N			M	M	M	P	Q	Q		
	0.68							J*	J*				N	N	N	N			M	M	M	Q	Q	Q		
	1.0							J*	J*				N	N	N*				M	M	Q	Q	Q	Q		
	1.5																		P	P	Q	Q	Q	Q		
	2.2					J*									P*				Q	Q	Q	Q	Q	Q		
	3.3																									
	4.7												P*	P*					Q*	Q*	Q*					
	10																		P*	P*						
	22																			Q*						
	47																									
	100																									
WVDC		16	25	50	6.3	10	16	25	50	100	200	6.3	10	16	25	50	100	200	6.3	10	16	25	50	100	200	500
SIZE		AU02			AU03						AU05						AU06									

\* Contact factory

Letter	A	C	E	G	J	K	M	N	P	Q	X	Y	Z
Max. Thickness	0.33 (0.013)	0.56 (0.022)	0.71 (0.028)	0.90 (0.035)	0.94 (0.037)	1.02 (0.040)	1.27 (0.050)	1.40 (0.055)	1.52 (0.060)	1.78 (0.070)	2.29 (0.090)	2.54 (0.100)	2.79 (0.110)
	PAPER					EMBOSSSED							

= Under Development

# MLCC Gold Termination – AU Series



## Capacitance Range (X7R Dielectric)

PREFERRED SIZES ARE SHADED

SIZE	AU10								AU12				AU13		AU14	
	Reflow/Epoxy/ Wire Bond*								Reflow/Epoxy/ Wire Bond*				Reflow/Epoxy/ Wire Bond*		Reflow/Epoxy/ Wire Bond*	
Packaging	Paper/Embossed								All Embossed				All Embossed		All Embossed	
(L) Length	3.20 ± 0.20 (0.126 ± 0.008)								4.50 ± 0.30 (0.177 ± 0.012)				4.50 ± 0.30 (0.177 ± 0.012)		5.72 ± 0.25 (0.225 ± 0.010)	
(W) Width	2.50 ± 0.20 (0.098 ± 0.008)								3.20 ± 0.20 (0.126 ± 0.008)				6.40 ± 0.40 (0.252 ± 0.016)		6.35 ± 0.25 (0.250 ± 0.010)	
(t) Terminal	0.50 ± 0.25 (0.020 ± 0.010)								0.61 ± 0.36 (0.024 ± 0.014)				0.61 ± 0.36 (0.024 ± 0.014)		0.64 ± 0.39 (0.025 ± 0.015)	
WVDC	10	16	25	50	100	200	500	50	100	200	500	50	100	50	100	
Cap (pF)	100															
	150															
	220															
	330															
	470															
	680															
	1000															
	1500	J	J	J	J	J	J	M								
	2200	J	J	J	J	J	J	M								
	3300	J	J	J	J	J	J	M								
	4700	J	J	J	J	J	J	M								
	6800	J	J	J	J	J	J	M								
Cap (µF)	0.010	J	J	J	J	J	J	M	K	K	K	K	M	M	M	P
	0.015	J	J	J	J	J	J	P	K	K	K	P	M	M	M	P
	0.022	J	J	J	J	J	J	Q	K	K	K	P	M	M	M	P
	0.033	J	J	J	J	J	J	Q	K	K	K	X	M	M	M	P
	0.047	J	J	J	J	J	J		K	K	K	Z	M	M	M	P
	0.068	J	J	J	J	J	M		K	K	K	Z	M	M	M	P
	0.10	J	J	J	J	J	M		K	K	K	Z	M	M	M	P
	0.15	J	J	J	J	M	Z		K	K	P		M	M	M	P
	0.22	J	J	J	J	P	Z		K	K	P		M	M	M	P
	0.33	J	J	J	J	Q			K	M	X		M	M	M	P
	0.47	M	M	M	M	Q			K	P			M	M	M	P
	0.68	M	M	P	X	X			M	Q			M	P	M	P
	1.0	N	N	P	X	Z			M	X			M	P	M	P
	1.5	N	N	Z	Z	Z			Z	Z			M		M	X
	2.2	X	X	Z	Z	Z			Z	Z					M	
	3.3	X	X	Z	Z				Z							
	4.7	X	X	Z	Z				Z							
	10	Z	Z	Z												
	22	Z	Z													
	47															
	100															
WVDC	10	16	25	50	100	200	500	50	100	200	500	50	100	50	100	
SIZE	AU10								AU12				AU13		AU14	

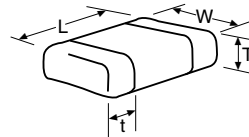

\* Contact factory

Letter	A	C	E	G	J	K	M	N	P	Q	X	Y	Z
Max. Thickness	0.33 (0.013)	0.56 (0.022)	0.71 (0.028)	0.90 (0.035)	0.94 (0.037)	1.02 (0.040)	1.27 (0.050)	1.40 (0.055)	1.52 (0.060)	1.78 (0.070)	2.29 (0.090)	2.54 (0.100)	2.79 (0.110)
	PAPER					EMBOSSSED							



# MLCC Gold Termination – AU Series



## 0612/0508/0306/Gold LICC (Low Inductance Chip Capacitors)

SIZE	0306					0508					0612					
Packaging	Embossed					Embossed					Embossed					
Length mm (in.)	0.81 ± 0.15 (0.032 ± 0.006)					1.27 ± 0.25 (0.050 ± 0.010)					1.60 ± 0.25 (0.063 ± 0.010)					
Width mm (in.)	1.60 ± 0.15 (0.063 ± 0.006)					2.00 ± 0.25 (0.080 ± 0.010)					3.20 ± 0.25 (0.126 ± 0.010)					
WVDC	4	6.3	10	16	25	50	6.3	10	16	25	50	6.3	10	16	25	50
CAP (µF)	0.001					0.0022					0.0047					
	0.010					0.015					0.022					
	0.047					0.068					0.10					
	0.15					0.22					0.47					
	0.68					1.0					1.5					
	2.2					3.3					4.7					
	10															

Solid = X7R      = X5R

= X7S      = X6S

mm (in.)	
0306	
Code	Thickness
A	0.61 (0.024)

mm (in.)	
0508	
Code	Thickness
S	0.56 (0.022)
V	0.76 (0.030)
A	1.02 (0.040)

mm (in.)	
0612	
Code	Thickness
S	0.56 (0.022)
V	0.76 (0.030)
W	1.02 (0.040)
A	1.27 (0.050)

### PHYSICAL DIMENSIONS AND PAD LAYOUT

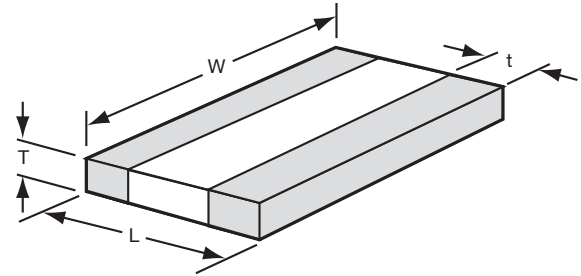

### PHYSICAL CHIP DIMENSIONS mm (in)

	L	W	t
0612	1.60 ± 0.25 (0.063 ± 0.010)	3.20 ± 0.25 (0.126 ± 0.010)	0.13 min. (0.005 min.)
0508	1.27 ± 0.25 (0.050 ± 0.010)	2.00 ± 0.25 (0.080 ± 0.010)	0.13 min. (0.005 min.)
0306	0.81 ± 0.15 (0.032 ± 0.006)	1.60 ± 0.15 (0.063 ± 0.006)	0.13 min. (0.005 min.)

T - See Range Chart for Thickness and Codes

### PAD LAYOUT DIMENSIONS mm (in)

	A	B	C
0612	0.76 (0.030)	3.05 (0.120)	.635 (0.025)
0508	0.51 (0.020)	2.03 (0.080)	0.51 (0.020)
0306	0.31 (0.012)	1.52 (0.060)	0.51 (0.020)

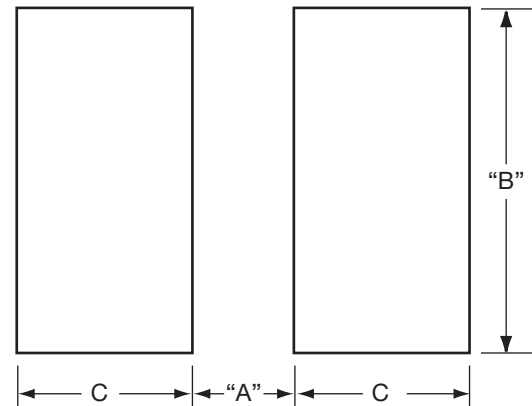

# MLCC Tin/Lead Termination “B”



## General Specifications

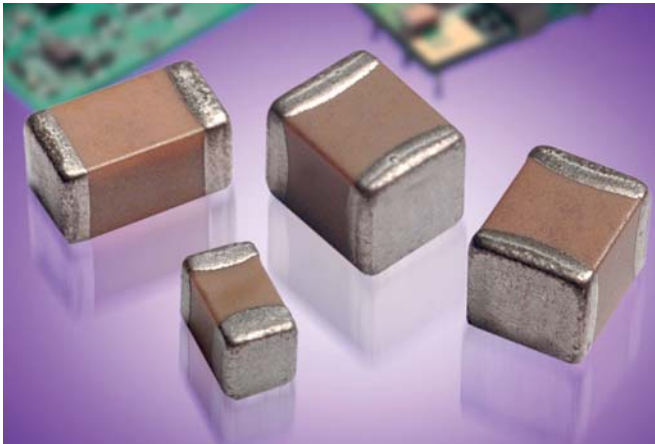

AVX Corporation will support those customers for commercial and military Multilayer Ceramic Capacitors with a termination consisting of 5% minimum lead. This termination is indicated by the use of a “B” in the 12th position of the AVX Catalog Part Number. This fulfills AVX’s commitment to providing a full range of products to our customers. AVX has provided in the following pages a full range of values that we are currently offering in this special “B” termination. Please contact the factory if you require additional information on our MLCC Tin/Lead Termination “B” products.

**Not RoHS Compliant**

### PART NUMBER (see page 2 for complete part number explanation)

LD05	5	A	101	J	A	B	2	A
<b>Size</b>	<b>Voltage</b>	<b>Dielectric</b>	<b>Capacitance Code (In pF)</b>	<b>Capacitance Tolerance</b>	<b>Failure Rate</b>	<b>Terminations</b>	<b>Packaging</b>	<b>Special Code</b>
LD02 - 0402 LD03 - 0603 LD04 - 0504* LD05 - 0805 LD06 - 1206 LD10 - 1210 LD12 - 1812 LD13 - 1825 LD14 - 2225 LD20 - 2220	6.3V = 6 10V = Z 16V = Y 25V = 3 35V = D 50V = 5 100V = 1 200V = 2 500V = 7	COG (NP0) = A X7R = C X5R = D X8R = F	2 Sig. Digits + Number of Zeros	B = ±.10 pF (<10pF) C = ±.25 pF (<10pF) D = ±.50 pF (<10pF) F = ±1% (≥ 10 pF) G = ±2% (≥ 10 pF) J = ±5% K = ±10% M = ±20%	A = Not Applicable	B = 5% min lead X = FLEXITERM® with 5% min lead**	2 = 7" Reel 4 = 13" Reel 7 = Bulk Cass. 9 = Bulk	A = Std. Product
						**X7R only	<b>Contact Factory For Multiples</b>	

\*LD04 has the same CV ranges as LD03.

NOTE: Contact factory for availability of Tolerance Options for Specific Part Numbers.  
Contact factory for non-specified capacitance values.

See FLEXITERM® section  
for CV options

NP0	Refer to page 4 for Electrical Graphs
X7R	Refer to page 17 for Electrical Graphs
X7S	Refer to page 21 for Electrical Graphs
X5R	Refer to page 24 for Electrical Graphs
Y5V	Refer to page 27 for Electrical Graphs



# MLCC Tin/Lead Termination "B"



## Capacitance Range (NP0 Dielectric)

PREFERRED SIZES ARE SHADED

SIZE		LD10					LD12					LD13			LD14		
Soldering		Reflow Only					Reflow Only					Reflow Only			Reflow Only		
Packaging		Paper/Embossed					All Embossed					All Embossed			All Embossed		
(L) Length	mm	3.20 ± 0.20 (0.126 ± 0.008)					4.50 ± 0.30 (0.177 ± 0.012)					4.50 ± 0.30 (0.177 ± 0.012)			5.72 ± 0.25 (0.225 ± 0.010)		
(W) Width	mm	2.50 ± 0.20 (0.098 ± 0.008)					3.20 ± 0.20 (0.126 ± 0.008)					6.40 ± 0.40 (0.252 ± 0.016)			6.35 ± 0.25 (0.250 ± 0.010)		
(t) Terminal	mm	0.50 ± 0.25 (0.020 ± 0.010)					0.61 ± 0.36 (0.024 ± 0.014)					0.61 ± 0.36 (0.024 ± 0.014)			0.64 ± 0.39 (0.025 ± 0.015)		
WVDC		25	50	100	200	500	25	50	100	200	500	50	100	200	50	100	200
Cap (pF)	0.5																
	1.0																
	1.2																
	1.5																
	1.8																
	2.2																
	2.7																
	3.3																
	3.9																
	4.7																
	5.6																
	6.8																
	8.2																
	10					J											
	12					J											
	15					J											
	18					J											
	22					J											
	27					J											
	33					J											
	39					J											
	47					J											
	56					J											
	68					J											
	82					J											
	100					J											
	120					J											
	150					J											
	180					J											
	220					J											
	270					J											
	330					J											
	390					M											
	470					M											
	560	J	J	J	J	M											
	680	J	J	J	J	M											
	820	J	J	J	J	M											
	1000	J	J	J	J	M	K	K	K	K	M	M	M	M	M	M	P
	1200	J	J	J	M	M	K	K	K	K	M	M	M	M	M	M	P
	1500	J	J	J	M	M	K	K	K	K	M	M	M	M	M	M	P
	1800	J	J	J	M		K	K	K	K	M	M	M	M	M	M	P
	2200	J	J	J	Q		K	K	K	K	P	M	M	M	M	M	P
	2700	J	J	J	Q		K	K	K	P	Q	M	M	M	M	M	P
	3300	J	J	J			K	K	K	P	Q	M	M	M	M	M	P
	3900	J	J	M			K	K	K	P	Q	M	M	M	M	M	P
	4700	J	J	M			K	K	K	P	Q	M	M	M	M	M	P
	5600	J	J				K	K	M	P	X	M	M	M	M	M	P
	6800	J	J				K	K	M	X		M	M	M	M	M	P
	8200	J	J				K	M	M			M	M		M	M	P
Cap (µF)	0.010	J	J				K	M	M			M	M		M	M	P
	0.012	J	J				K	M				M	M		M	M	P
	0.015						M	M				M	M		M	M	Y
	0.018						M	M				P	M		M	M	Y
	0.022						M	M				P			M	Y	Y
	0.027						M	M				P			P	Y	Y
	0.033						M	M				P			P		
	0.039						M	M				P			P		
	0.047						M	M				P			P		
	0.068						M	M							P		
	0.082						M	M							Q		
	0.1														Q		
WVDC		25	50	100	200	500	25	50	100	200	500	50	100	200	50	100	200

SIZE	LD10					LD12					LD13			LD14		
Letter	A	C	E	G	J	K	M	N	P	Q	X	Y	Z			
Max. Thickness	0.33 (0.013)	0.56 (0.022)	0.71 (0.028)	0.90 (0.035)	0.94 (0.037)	1.02 (0.040)	1.27 (0.050)	1.40 (0.055)	1.52 (0.060)	1.78 (0.070)	2.29 (0.090)	2.54 (0.100)	2.79 (0.110)			
	PAPER					EMBOSSSED										



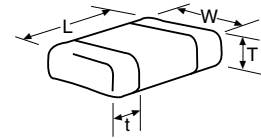

# MLCC Tin/Lead Termination “B”



## Capacitance Range (X8R Dielectric)

SIZE		LD03		LD05		LD06	
	WVDC	25V	50V	25V	50V	25V	50V
271	Cap 270	G	G				
331	(pF) 330	G	G	J	J		
471	470	G	G	J	J		
681	680	G	G	J	J		
102	1000	G	G	J	J	J	J
152	1500	G	G	J	J	J	J
182	1800	G	G	J	J	J	J
222	2200	G	G	J	J	J	J
272	2700	G	G	J	J	J	J
332	3300	G	G	J	J	J	J
392	3900	G	G	J	J	J	J
472	4700	G	G	J	J	J	J
562	5600	G	G	J	J	J	J
682	6800	G	G	J	J	J	J
822	8200	G	G	J	J	J	J
103	Cap 0.01	G	G	J	J	J	J
123	(µF) 0.012	G	G	J	J	J	J
153	0.015	G	G	J	J	J	J
183	0.018	G	G	J	J	J	J
223	0.022	G	G	J	J	J	J
273	0.027	G	G	J	J	J	J
333	0.033	G	G	J	J	J	J
393	0.039	G	G	J	J	J	J
473	0.047	G	G	J	J	J	J
563	0.056	G		N	N	M	M
683	0.068	G		N	N	M	M
823	0.082			N	N	M	M
104	0.1			N	N	M	M
124	0.12			N	N	M	M
154	0.15			N	N	M	M
184	0.18			N		M	M
224	0.22			N		M	M
274	0.27					M	M
334	0.33					M	M
394	0.39					M	
474	0.47					M	
684	0.68						
824	0.82						
105	1						
SIZE	WVDC	25V	50V	25V	50V	25V	50V
		LD03		LD05		LD06	

Letter	A	C	E	G	J	K	M	N	P	Q	X	Y	Z
Max. Thickness	0.33 (0.013)	0.56 (0.022)	0.71 (0.028)	0.90 (0.035)	0.94 (0.037)	1.02 (0.040)	1.27 (0.050)	1.40 (0.055)	1.52 (0.060)	1.78 (0.070)	2.29 (0.090)	2.54 (0.100)	2.79 (0.110)
	PAPER					EMBOSSSED							

# MLCC Tin/Lead Termination “B”



## Capacitance Range (X7R Dielectric)

PREFERRED SIZES ARE SHADED

SIZE	LD02			LD03						LD05						LD06										
	Reflow/Wave			Reflow/Wave						Reflow/Wave						Reflow/Wave										
Soldering	All Paper			All Paper						Paper/Embossed						Paper/Embossed										
Packaging	All Paper			All Paper						Paper/Embossed						Paper/Embossed										
(L) Length	mm	1.00 ± 0.10		1.60 ± 0.15						2.01 ± 0.20						3.20 ± 0.20										
(W) Width	mm	0.50 ± 0.10		0.81 ± 0.15						1.25 ± 0.20						1.60 ± 0.20										
(t) Terminal	mm	0.25 ± 0.15		0.35 ± 0.15						0.50 ± 0.25						0.50 ± 0.25										
	(in.)	(0.010 ± 0.006)		(0.014 ± 0.006)						(0.020 ± 0.010)						(0.020 ± 0.010)										
WVDC		16	25	50	6.3	10	16	25	50	100	200	6.3	10	16	25	50	100	200	6.3	10	16	25	50	100	200	500
Cap (pF)	100																									
	150																									
	220			C																						
	330			C					G	G	G			J	J	J	J	J								K
	470			C					G	G	G			J	J	J	J	J								K
	680			C					G	G	G			J	J	J	J	J								K
	1000			C					G	G	G			J	J	J	J	J								K
	1500			C					G	G	G			J	J	J	J	J			J	J	J	J	J	M
	2200			C					G	G	G			J	J	J	J	J			J	J	J	J	J	M
	3300		C	C					G	G	G			J	J	J	J	J			J	J	J	J	J	M
	4700		C	C					G	G	G			J	J	J	J	J			J	J	J	J	J	M
	6800	G	C	C					G	G	G			J	J	J	J	J			J	J	J	J	J	P
Cap (µF)	0.010	C	C						G	G	G			J	J	J	J	J			J	J	J	J	J	P
	0.015	C	C						G	G	G			J	J	J	J	J			J	J	J	J	J	M
	0.022	C	C						G	G	G			J	J	J	J	J	N		J	J	J	J	J	M
	0.033								G	G	G			J	J	J	J	N			J	J	J	J	J	M
	0.047								G	G	G			J	J	J	J	N			J	J	J	J	J	M
	0.068								G	G	G			J	J	J	J	N			J	J	J	J	J	P
	0.10		C*						G	G	G			J	J	J	J	N			J	J	J	J	M	P
	0.15				G	G								J	J	J	N	N			J	J	J	J	J	
	0.22				G	G								J	J	N	N	N			J	J	J	J	Q	
	0.33													N	N	N	N	N			J	J	M	P	Q	
	0.47							J*						N	N	N	N	N			M	M	M	P	Q	
	0.68							J*	J*					N	N	N	N	N			M	M	Q	Q	Q	
	1.0													N	N	N*					M	M	Q	Q	Q	
	1.5																				P	Q	Q	Q	Q	
	2.2				J*												P*				Q	Q	Q	Q	Q	
	3.3																									
	4.7																									
	10																									
	22																									
	47																									
	100																									
WVDC		16	25	50	6.3	10	16	25	50	100	200	6.3	10	16	25	50	100	200	6.3	10	16	25	50	100	200	500
SIZE	LD02	LD03						LD05						LD06												

Letter	A	C	E	G	J	K	M	N	P	Q	X	Y	Z
Max.	0.33	0.56	0.71	0.90	0.94	1.02	1.27	1.40	1.52	1.78	2.29	2.54	2.79
Thickness	(0.013)	(0.022)	(0.028)	(0.035)	(0.037)	(0.040)	(0.050)	(0.055)	(0.060)	(0.070)	(0.090)	(0.100)	(0.110)
	PAPER					EMBOSSSED							

= Under Development

# MLCC Tin/Lead Termination "B"



## Capacitance Range (X7R Dielectric)

PREFERRED SIZES ARE SHADED

SIZE		LD10							LD12				LD13		LD20				LD14	
Soldering		Reflow Only							Reflow Only				Reflow Only		Reflow Only				Reflow Only	
Packaging		Paper/Embossed							All Embossed				All Embossed		All Embossed				All Embossed	
(L) Length	mm (in.)	3.20 ± 0.20 (0.126 ± 0.008)							4.50 ± 0.30 (0.177 ± 0.012)				4.50 ± 0.30 (0.177 ± 0.012)		5.70 ± 0.40 (0.225 ± 0.016)				5.72 ± 0.25 (0.225 ± 0.010)	
(W) Width	mm (in.)	2.50 ± 0.20 (0.098 ± 0.008)							3.20 ± 0.20 (0.126 ± 0.008)				6.40 ± 0.40 (0.252 ± 0.016)		5.00 ± 0.40 (0.197 ± 0.016)				6.35 ± 0.25 (0.250 ± 0.010)	
(t) Terminal	mm (in.)	0.50 ± 0.25 (0.020 ± 0.010)							0.61 ± 0.36 (0.024 ± 0.014)				0.61 ± 0.36 (0.024 ± 0.014)		0.64 ± 0.39 (0.025 ± 0.015)				0.64 ± 0.39 (0.025 ± 0.015)	
WVDC		10	16	25	50	100	200	500	50	100	200	500	50	100	25	50	100	200	50	100
Cap (pF)	100																			
	150																			
	220																			
	330																			
	470																			
	680																			
	1000	J	J	J	J	J	J	M												
	1500	J	J	J	J	J	J	M												
	2200	J	J	J	J	J	J	M												
	3300	J	J	J	J	J	J	M												
	4700	J	J	J	J	J	J	M												
	6800	J	J	J	J	J	J	M												
Cap (µF)	0.010	J	J	J	J	J	J	M	K	K	K	K	M	M		X	X	X	M	P
	0.015	J	J	J	J	J	J	P	K	K	K	P	M	M		X	X	X	M	P
	0.022	J	J	J	J	J	J	Q	K	K	K	P	M	M		X	X	X	M	P
	0.033	J	J	J	J	J	J	Q	K	K	K	X	M	M		X	X	X	M	P
	0.047	J	J	J	J	J	J		K	K	K	Z	M	M		X	X	X	M	P
	0.068	J	J	J	J	J	M		K	K	K	Z	M	M		X	X	X	M	P
	0.10	J	J	J	J	J	M		K	K	K	Z	M	M		X	X	X	M	P
	0.15	J	J	J	J	M	Z		K	K	P		M	M		X	X	X	M	P
	0.22	J	J	J	J	P	Z		K	K	P		M	M		X	X	X	M	P
	0.33	J	J	J	J	Q			K	M	X		M	M		X	X	X	M	P
	0.47	M	M	M	M	Q			K	P			M	M		X	X	X	M	P
	0.68	M	M	P	X	X			M	Q			M	P		X	X		M	P
	1.0	N	N	P	X	Z			M	X			M	P		X	X		M	P
	1.5	N	N	Z	Z	Z			Z	Z			M			X	X		M	X
	2.2	X	X	Z	Z	Z			Z	Z						X	X		M	
	3.3	X	X	Z	Z				Z							X	Z			
	4.7	X	X	Z	Z				Z							X	Z			
	10	Z	Z	Z												Z				
	22	Z	Z												Z					
	47																			
	100																			
WVDC		10	16	25	50	100	200	500	50	100	200	500	50	100	25	50	100	200	50	100
SIZE		LD10							LD12				LD13		LD20				LD14	

Letter	A	C	E	G	J	K	M	N	P	Q	X	Y	Z
Max. Thickness	0.33 (0.013)	0.56 (0.022)	0.71 (0.028)	0.90 (0.035)	0.94 (0.037)	1.02 (0.040)	1.27 (0.050)	1.40 (0.055)	1.52 (0.060)	1.78 (0.070)	2.29 (0.090)	2.54 (0.100)	2.79 (0.110)
	PAPER					EMBOSS							



# MLCC Tin/Lead Termination “B”



## Capacitance Range (X5R Dielectric)

PREFERRED SIZES ARE SHADED

SIZE	LD02	LD03	LD05	LD06	LD10	LD12
<b>Soldering</b>	Reflow/Wave	Reflow/Wave	Reflow/Wave	Reflow/Wave	Reflow/Wave	
<b>Packaging</b>	All Paper	All Paper	Paper/Embossed	Paper/Embossed	Paper/Embossed	
(L) Length	mm (in.)	1.60 ± 0.15 (0.063 ± 0.006)	2.01 ± 0.20 (0.079 ± 0.008)	3.20 ± 0.20 (0.126 ± 0.008)	3.20 ± 0.20 (0.126 ± 0.008)	
(W) Width	mm (in.)	0.50 ± 0.10 (0.020 ± 0.004)	0.81 ± 0.15 (0.032 ± 0.006)	1.25 ± 0.20 (0.049 ± 0.008)	1.60 ± 0.20 (0.063 ± 0.008)	
(t) Terminal	mm (in.)	0.25 ± 0.15 (0.010 ± 0.006)	0.35 ± 0.15 (0.014 ± 0.006)	0.50 ± 0.25 (0.020 ± 0.010)	0.50 ± 0.25 (0.020 ± 0.010)	
WVDC	4 6.3 10 16 25 50	4 6.3 10 16 25 35 50	6.3 10 16 25 35 50	6.3 10 16 25 35 50	4 6.3 10 16 25 35 50	6.3 10 25 50
Cap (pF)	100 150 220	C				
	330 470 680	C C C				
	1000 1500 2200	C C C				
	3300 4700 6800	C	G			
Cap (µF)	0.010 0.015 0.022	C C C	G G G		N	
	0.033 0.047 0.068	C C C	G G G		N N N	
	0.10 0.15 0.22	C C*	G G		N N N	
	0.33 0.47 0.68	C* C*	G G G		N N N	Q Q
	1.0 1.5 2.2	C* C*	G G G	J*	N N	P*
	3.3 4.7 10	E*	J* J* K*	J* J* J*	N N N	N* N*
	22 47 100				P* P*	Q* Q*

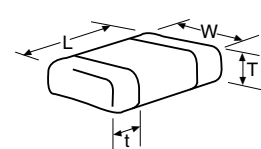

Letter	A	C	E	G	J	K	M	N	P	Q	X	Y	Z
<b>Max. Thickness</b>	0.33 (0.013)	0.56 (0.022)	0.71 (0.028)	0.90 (0.035)	0.94 (0.037)	1.02 (0.040)	1.27 (0.050)	1.40 (0.055)	1.52 (0.060)	1.78 (0.070)	2.29 (0.090)	2.54 (0.100)	2.79 (0.110)
	PAPER					EMBOSS							

- = Under Development
- = \*Optional Specifications – Contact factory

NOTE: Contact factory for non-specified capacitance values



# MLCC Low Profile

## General Specifications

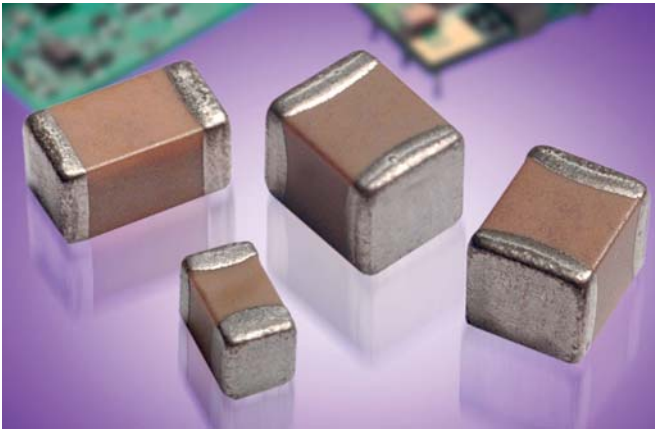

### GENERAL DESCRIPTION

AVX introduces the LT series comprising a range of low profile products in our X5R and X7R dielectric. X5R is a Class II dielectric with temperature variation of capacitance within  $\pm 15\%$  from  $-55^{\circ}\text{C}$  to  $+85^{\circ}\text{C}$ . Offerings include 0201, 0402, 0603, 0805, 1206, and 1210 packages in compact, low profile designs. The LT series is ideal for decoupling and filtering applications where height clearance is limited.

AVX is also expanding the low profile products in our X7R dielectric. X7R is a Class II dielectric with temperature variation of capacitance within  $\pm 15\%$  from  $-55^{\circ}\text{C}$  to  $+125^{\circ}\text{C}$ . Please contact the factory for availability of any additional values not listed.

### PART NUMBER (see page 2 for complete part number explanation)

<b>LT05</b>	<b>Z</b>	<b>D</b>	<b>475</b>	<b>K</b>	<b>A</b>	<b>T</b>	<b>2</b>	<b>S</b>
<b>Size</b>	<b>Voltage</b>	<b>Dielectric</b>	<b>Capacitance Code (In pF)</b>	<b>Capacitance Tolerance</b>	<b>Failure Rate</b>	<b>Terminations</b>	<b>Packaging</b>	<b>Special Code</b>
LT01 - 0201 LT02 - 0402 LT03 - 0603 LT05 - 0805 LT06 - 1206 LT10 - 1210	4V = 4 6.3V = 6 10V = Z 16V = Y 25V = 3	X5R = D X7R = C	2 Sig. Digits + Number of Zeros	K = $\pm 10\%$ M = $\pm 20\%$	A = Not Applicable	T = Plated Ni and Sn	2 = 7" Reel 4 = 13" Reel 7 = Bulk Cass. 9 = Bulk	See table below
							<b>Contact Factory For Multiples</b>	

NOTE: Contact factory for availability of tolerance options for specific part numbers.

SIZE		LT01	LT02			LT03				LT05				LT06			LT10		
WVDC		4	4	6.3	10	16	4	6.3	16	25	6.3	10	16	25	10	16	25	16	25
Cap ( $\mu\text{F}$ )	104	0.10	Z		Q		S												
		0.22								X									
		0.47								X							X		
105	1.0		C		S				S	X			X	X					
	1.5												X						
	2.2		S					S	X				X						
	4.7						S	X				S	X			W	W	W	
106	10						X/W				X	X			W		W		
	22														W		W		
	47																		
WVDC		4	4	6.3	10	16	4	6.3	16	25	6.3	10	16	25	10	16	25	16	25
SIZE		LT01	LT02			LT03				LT05				LT06			LT10		

X = X7R

Letter	J	Z	Q	C	S	X	W
Max. Thickness	0.15 (0.006)	0.22 (0.009)	0.25 (0.010)	0.36 (0.014)	0.56 (0.022)	0.95 (0.038)	1.02 (0.040)
	PAPER						EMBOSSED

# UltraThin Ceramic Capacitors



## UT023D103MAT2C

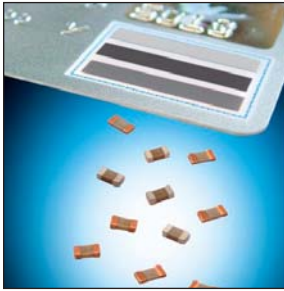

The Ultrathin (UT) series of ceramic capacitors is a new product offering from AVX. The UT series was designed to meet the stringent thickness requirements of our customers. AVX developed a new termination process (FCT - Fine Copper Termination) that provides unbeatable flatness and repeatability. The series includes products < 0.35mm in height and is targeted for applications such as Smart cards, Memory modules, High Density SIM cards, Mobile phones, MP3 players, and embedded solutions.



### HOW TO ORDER

<b>UT</b>	<b>02</b>	<b>3</b>	<b>D</b>	<b>103</b>	<b>M</b>	<b>A</b>	<b>T</b>	<b>2</b>	<b>C</b>
<b>Style</b> Ultra Thin	<b>Case Size</b> 0402	<b>Rated Voltage</b> 25V	<b>Temperature Characteristic</b> X5R	<b>Coded Cap</b> 0.01 $\mu$ F	<b>Cap Tolerance</b> $\pm 20\%$	<b>Termination Style</b> Commercial	<b>Termination</b> 100% Sn	<b>Packaging</b> 7" Reel = 15,000 pcs 13" Reel = 50,000 pcs	<b>Thickness</b> 0.30mm max

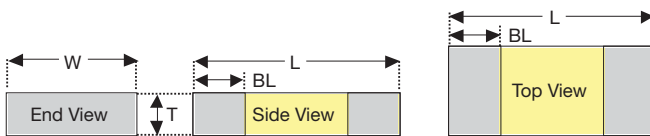

### RECOMMENDED SOLDER PAD DIMENSIONS

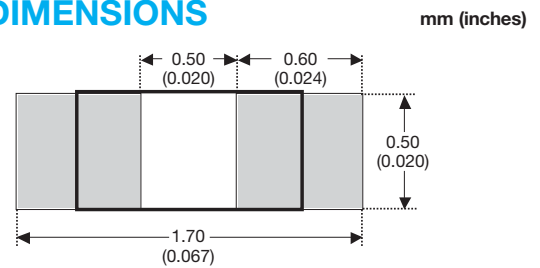

### PART DIMENSIONS

inches (mm)			
L	W	T	BL
1.00 $\pm$ 0.10 (0.039 $\pm$ 0.004)	0.50 $\pm$ 0.10 (0.020 $\pm$ 0.004)	0.25 $\pm$ 0.05 (0.010 $\pm$ 0.002)	0.25 $\pm$ 0.10 (0.010 $\pm$ 0.004)

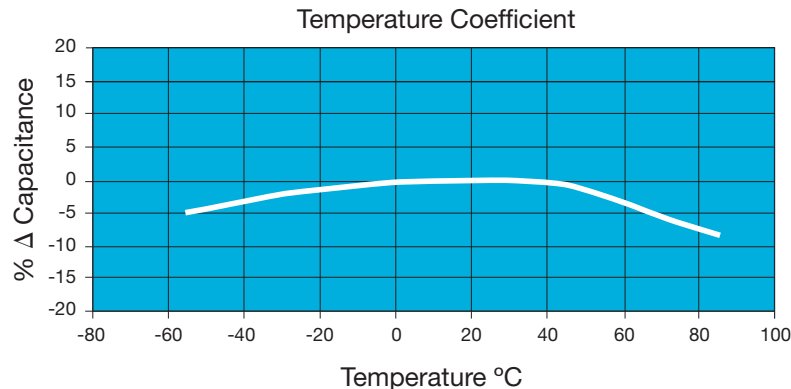

### PERFORMANCE CHARACTERISTICS

Capacitance Value	0.01 $\mu$ F
Capacitance Tolerance	$\pm 20\%$
Dissipation Factor Range	3.0%
Operating Temperature	-55 $^{\circ}$ C to +85 $^{\circ}$ C
Temperature Coefficient	$\pm 15\%$
Rated Voltage	25V
Insulation Resistance at 25 $^{\circ}$ C and Rated Voltage	100,000 Mohms
Test Frequency	1 Vrms @ 1 KHz



### GENERAL DESCRIPTION

AVX Corporation has supported the Automotive Industry requirements for Multilayer Ceramic Capacitors consistently for more than 10 years. Products have been developed and tested specifically for automotive applications and all manufacturing facilities are QS9000 and VDA 6.4 approved.

As part of our sustained investment in capacity and state of the art technology, we are now transitioning from the established Pd/Ag electrode system to a Base Metal Electrode system (BME).

AVX is using AECQ200 as the qualification vehicle for this transition. A detailed qualification package is available on request and contains results on a range of part numbers including:

- X7R dielectric components containing BME electrode and copper terminations with a Ni/Sn plated overcoat.
- X7R dielectric components, BME electrode with epoxy finish for conductive glue mounting.
- X7R dielectric components BME electrode and soft terminations with a Ni/Sn plated overcoat.
- NP0 dielectric components containing Pd/Ag electrode and silver termination with a Ni/Sn plated overcoat.

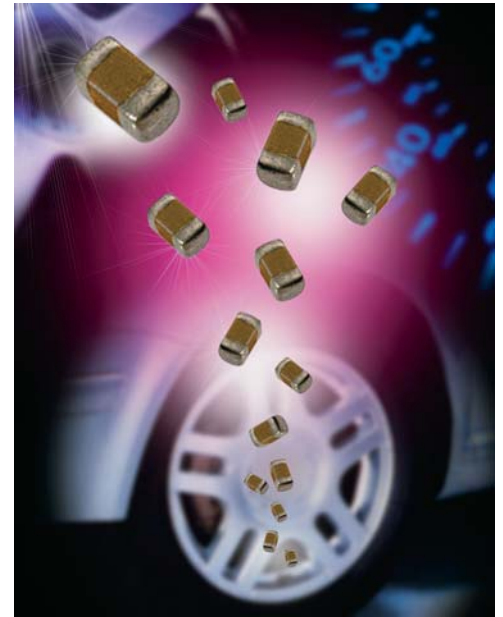

### HOW TO ORDER

0805	5	A	104	K	4	T	2	A
Size	Voltage	Dielectric	Capacitance Code (In pF)	Capacitance Tolerance	Failure Rate	Terminations	Packaging	Special Code
0402	10V = Z	NP0 = A	2 Significant Digits + Number of Zeros	F = ±1% (≥10pF)* G = ±2% (≥10pF)* J = ±5% (≤1µF) K = ±10% M = ±20%	4 = Automotive	T = Plated Ni and Sn Z = FLEXITERM®** U = Conductive Epoxy**	2 = 7" Reel 4 = 13" Reel	A = Std. Product
0603	16V = Y	X7R = C	e.g. 10µF = 106					
0805	25V = 3	X8R = F						
1206	50V = 5							
1210	100V = 1							
1812	200V = 2							
	500V = 7							
						**X7R & X8R only		

\*NPO only

Contact factory for availability of Tolerance Options for Specific Part Numbers.

NOTE: Contact factory for non-specified capacitance values.  
0402 case size available in T termination only.



### COMMERCIAL VS AUTOMOTIVE MLCC PROCESS COMPARISON

	Commercial	Automotive
<b>Administrative</b>	Standard Part Numbers. No restriction on who purchases these parts.	Specific Automotive Part Number. Used to control supply of product to Automotive customers.
<b>Design</b>	Minimum ceramic thickness of 0.020"	Minimum Ceramic thickness of 0.029" (0.74mm) on all X7R product.
<b>Dicing</b>	Side & End Margins = 0.003" min	Side & End Margins = 0.004" min Cover Layers = 0.005" min
<b>Lot Qualification (Destructive Physical Analysis - DPA)</b>	As per EIA RS469	Increased sample plan – stricter criteria.
<b>Visual/Cosmetic Quality</b>	Standard process and inspection	100% inspection
<b>Application Robustness</b>	Standard sampling for accelerated wave solder on X7R dielectrics	Increased sampling for accelerated wave solder on X7R and NP0 followed by lot by lot reliability testing.

All Tests have Accept/Reject Criteria 0/1

# Automotive MLCC



## NP0/X7R Dielectric

### FLEXITERM® FEATURES

a) Bend Test

The capacitor is soldered to the PC Board as shown:

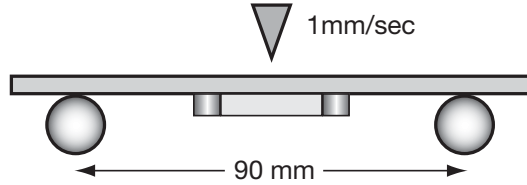

b) Temperature Cycle testing

FLEXITERM® has the ability to withstand at least 1000 cycles between -55°C and +125°C

Typical bend test results are shown below:

Style	Conventional Term	Soft Term
0603	>2mm	>5
0805	>2mm	>5
1206	>2mm	>5

### ELECTRODE AND TERMINATION OPTIONS

#### NP0 DIELECTRIC

**NP0 Ag/Pd Electrode  
Nickel Barrier Termination  
PCB Application**

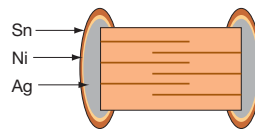

Figure 1 Termination Code T

#### X7R DIELECTRIC

**X7R Dielectric  
PCB Application**

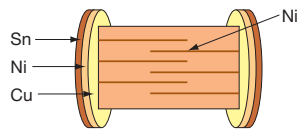

Figure 2 Termination Code T

**X7R Nickel Electrode  
Soft Termination  
PCB Application**

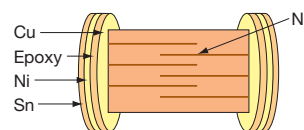

Figure 3 Termination Code Z

**Conductive Epoxy Termination  
Hybrid Application**

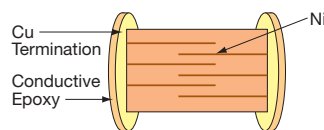

Figure 4 Termination Code U





# Automotive MLCC - NP0



## Capacitance Range

		0603			0805			1206					1210				1812	
		25V	50V	100V	25V	50V	100V	25V	50V	100V	200V	500V	25V	50V	100V	200V	50V	100V
100	10pF	G	G	G	J	J	J	J	J	J	J	J						
120	12	G	G	G	J	J	J	J	J	J	J	J						
150	15	G	G	G	J	J	J	J	J	J	J	J						
180	18	G	G	G	J	J	J	J	J	J	J	J						
220	22	G	G	G	J	J	J	J	J	J	J	J						
270	27	G	G	G	J	J	J	J	J	J	J	J						
330	33	G	G	G	J	J	J	J	J	J	J	J						
390	39	G	G	G	J	J	J	J	J	J	J	J						
470	47	G	G	G	J	J	J	J	J	J	J	J						
510	51	G	G	G	J	J	J	J	J	J	J	J						
560	56	G	G	G	J	J	J	J	J	J	J	J						
680	68	G	G	G	J	J	J	J	J	J	J	J						
820	82	G	G	G	J	J	J	J	J	J	J	J						
101	100	G	G	G	J	J	J	J	J	J	J	J						
121	120	G	G	G	J	J	J	J	J	J	J	J						
151	150	G	G	G	J	J	J	J	J	J	J	J						
181	180	G	G	G	J	J	J	J	J	J	J	J						
221	220	G	G	G	J	J	J	J	J	J	J	J						
271	270	G	G	G	J	J	J	J	J	J	J	J						
331	330	G	G	G	J	J	J	J	J	J	J	J						
391	390	G	G		J	J	J	J	J	J	J	J						
471	470	G	G		J	J	J	J	J	J	J	J						
561	560				J	J	J	J	J	J	J	J						
681	680				J	J	J	J	J	J	J	J						
821	820				J	J	J	J	J	J	J	J						
102	1000				J	J	J	J	J	J	J	J	J	J	J	J		
122	1200							J	J	J	J	J	J	J	M	M		
152	1500							J	M	M	M	M	J	J	M	M		
182	1800							J	M	M	M	M	J	J	M	M		
222	2200							J	M	M	M	M	J	J	M	M		
272	2700							J	M	Q			J	J	M			
332	3300							J	M	Q			J	J	P		K	K
392	3900												J	J	P		K	K
472	4700												J	J	P		K	K
103	10nF																	
		25V	50V	100V	25V	50V	100V	25V	50V	100V	200V	500V	25V	50V	100V	200V	50V	100V
		0603			0805			1206					1210				1812	

Letter	A	C	E	G	J	K	M	N	P	Q	X	Y	Z
Max. Thickness	0.33 (0.013)	0.56 (0.022)	0.71 (0.028)	0.90 (0.035)	0.94 (0.037)	1.02 (0.040)	1.27 (0.050)	1.40 (0.055)	1.52 (0.060)	1.78 (0.070)	2.29 (0.090)	2.54 (0.100)	2.79 (0.110)
	PAPER					EMBOSSSED							

 = Under Development

# Automotive MLCC - X7R



## Capacitance Range

		0402			0603				0805				1206					1210				1812		2220				
		16V	25V	50V	16V	25V	50V	100V	200V	16V	25V	50V	100V	200V	16V	25V	50V	100V	200V	500V	16V	25V	50V	100V	50V	100V	25V	50V
221	Cap .22																											
271	(nF) .27																											
331	.33																											
391	.39																											
471	.47																											
561	.56																											
681	.68																											
821	.82																											
102	1				G	G	G	G	G	J	J	J	J	J	J	J	J	J	J	J	J	K	K	K	K	K	K	
182	1.8				G	G	G	G		J	J	J	J	J	J	J	J	J	J	J	J	K	K	K	K	K	K	
222	2.2				G	G	G	G		J	J	J	J	J	J	J	J	J	J	J	J	K	K	K	K	K	K	
332	3.3				G	G	G	G		J	J	J	J	J	J	J	J	J	J	J	J	K	K	K	K	K	K	
472	4.7				G	G	G	G		J	J	J	J	J	J	J	J	J	J	J	J	K	K	K	K	K	K	
103	10				G	G	G	G		J	J	J	J	J	J	J	J	J	J	J	J	K	K	K	K	K	K	
123	12				G	G	G			J	J	J	M		J	J	J	J	J			K	K	K	K	K	K	
153	15				G	G	G			J	J	J	M		J	J	J	J	J			K	K	K	K	K	K	
183	18				G	G	G			J	J	J	M		J	J	J	J	J			K	K	K	K	K	K	
223	22				G	G	G			J	J	J	M		J	J	J	J	J			K	K	K	K	K	K	
273	27				G	G	G			J	J	J	M		J	J	J	J	J			K	K	K	K	K	K	
333	33				G	G	G			J	J	J	M		J	J	J	J	J			K	K	K	K	K	K	
473	47				G	G	G			J	J	J	M		J	J	J	M	J			K	K	K	K	K	K	
563	56				G	G	G			J	J	J	M		J	J	J	M	J			K	K	K	M	K	K	
683	68				G	G	G			J	J	J	M		J	J	J	M	J			K	K	K	M	K	K	
823	82				G	G	G			J	J	J	M		J	J	J	M	J			K	K	K	M	K	K	
104	100				G	G	G			J	J	M	M		J	J	J	M	J			K	K	K	M	K	K	
124	120									J	J	M			J	J	M	M				K	K	K	P	K	K	
154	150									M	N	M			J	J	M	M				K	K	K	P	K	K	
224	220									M	N	M			J	M	M	Q				M	M	M	P	M	M	
334	330									N	N	M			J	M	P	Q				P	P	P	Q	X	X	
474	470									N	N	M			M	M	P	Q				P	P	P	Q	X	X	
684	680									N	N				M	Q	Q	Q				P	P	Q	X	X	X	
105	Cap 1									N	N				M	Q	Q	Q				P	Q	Q	X	X	X	
155	(µF) 1.5														Q	Q						P	Q	Z	Z	X	X	
225	2.2														Q	Q						X	Z	Z	Z	Z	Z	
335	3.3																					X	Z	Z		Z		
475	4.7																					X	Z	Z		Z		
106	10																										Z	
226	22																										Z	
		16V	25V	50V	16V	25V	50V	100V	200V	16V	25V	50V	100V	200V	16V	25V	50V	100V	200V	500V	16V	25V	50V	100V	50V	100V	25V	50V
		0402			0603				0805				1206					1210				1812		2220				

= Under Development

Letter	A	C	E	G	J	K	M	N	P	Q	X	Y	Z
Max. Thickness	0.33 (0.013)	0.56 (0.022)	0.71 (0.028)	0.90 (0.035)	0.94 (0.037)	1.02 (0.040)	1.27 (0.050)	1.40 (0.055)	1.52 (0.060)	1.78 (0.070)	2.29 (0.090)	2.54 (0.100)	2.79 (0.110)
	PAPER					EMBOSSED							

# Automotive MLCC - X8R



## Capacitance Range

SIZE		0603		0805		1206	
	WVDC	25V	50V	25V	50V	25V	50V
271	Cap	G	G				
331	(pF)	G	G	J	J		
471		G	G	J	J		
681		G	G	J	J		
102		G	G	J	J	J	J
152		G	G	J	J	J	J
182		G	G	J	J	J	J
222		G	G	J	J	J	J
272		G	G	J	J	J	J
332		G	G	J	J	J	J
392		G	G	J	J	J	J
472		G	G	J	J	J	J
562		G	G	J	J	J	J
682		G	G	J	J	J	J
822		G	G	J	J	J	J
103	Cap	G	G	J	J	J	J
123	(µF)	G	G	J	J	J	J
153		G	G	J	J	J	J
183		G	G	J	J	J	J
223		G	G	J	J	J	J
273		G	G	J	J	J	J
333		G	G	J	J	J	J
393		G	G	J	J	J	J
473		G	G	J	J	J	J
563		G		N	N	M	M
683		G		N	N	M	M
823				N	N	M	M
104				N	N	M	M
124				N	N	M	M
154				N	N	M	M
184				N		M	M
224				N		M	M
274						M	M
334						M	M
394						M	
474						M	
684							
824							
105							
	WVDC	25V	50V	25V	50V	25V	50V
SIZE		0603		0805		1206	

Letter	A	C	E	G	J	K	M	N	P	Q	X	Y	Z
Max. Thickness	0.33 (0.013)	0.56 (0.022)	0.71 (0.028)	0.90 (0.035)	0.94 (0.037)	1.02 (0.040)	1.27 (0.050)	1.40 (0.055)	1.52 (0.060)	1.78 (0.070)	2.29 (0.090)	2.54 (0.100)	2.79 (0.110)
	PAPER					EMBOSSED							

= AEC-Q200 Qualified

# APS Series



## APS for COTS+ Applications

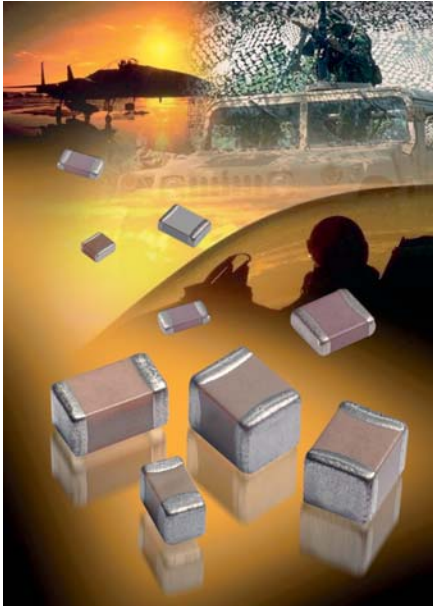

### GENERAL DESCRIPTION

As part of our continuing support to high reliability customers, AVX has launched an Automotive Plus Series of parts (APS) qualified and manufactured in accordance with automotive AEC-Q200 standard. Each production batch is quality tested to an enhanced requirement and shipped with a certificate of conformance. On a quarterly basis a reliability package is issued to all APS customers.

A detailed qualification package is available on request and contains results on a range of part numbers including:

- X7R dielectric components containing BME electrode and copper terminations with a Ni/Sn plated overcoat.
- X7R dielectric components BME electrode and soft terminations with a Ni/Sn plated overcoat (FLEXITERM®).
- X7R for Hybrid applications.
- NP0 dielectric components containing Pd/Ag electrode and silver termination with a Ni/Sn plated overcoat.

We are also able to support customers who require an AEC-Q200 grade component finished with Tin/Lead.

### HOW TO ORDER

AP03	5	A	104	K	Q	T	2	A
Size	Voltage	Dielectric	Capacitance Code (In pF)	Capacitance Tolerance	Failure Rate Q = APS	Terminations	Packaging	Special Code
AP03=0603	16V = Y	NP0 = A	2 Significant Digits + Number of Zeros e.g. 10µF = 106	J = ±5% K = ±10% M = ±20%		T = Plated Ni and Sn** Z = FLEXITERM®** U = Conductive Epoxy** B = 5% min lead X = FLEXITERM® with 5% min lead	2 = 7" Reel 4 = 13" Reel	A = Std. Product
AP05=0805	25V = 3	X7R = C						
AP06=1206	50V = 5							
AP10=1210	100V = 1							
AP12=1812	200V = 2 500V = 7							

Z, U, X for X7R only

**\*\*RoHS compliant**

NOTE: Contact factory for availability of Termination and Tolerance Options for Specific Part Numbers.

**Not RoHS Compliant**



For RoHS compliant products, please select correct termination style.

# NP0 Automotive Plus Series / APS



## Capacitance Range

		0603			0805			1206					1210				1812	
		25V	50V	100V	25V	50V	100V	25V	50V	100V	200V	500V	25V	50V	100V	200V	50V	100V
100	10pF	G	G	G	J	J	J	J	J	J	J	J						
120	12	G	G	G	J	J	J	J	J	J	J	J						
150	15	G	G	G	J	J	J	J	J	J	J	J						
180	18	G	G	G	J	J	J	J	J	J	J	J						
220	22	G	G	G	J	J	J	J	J	J	J	J						
270	27	G	G	G	J	J	J	J	J	J	J	J						
330	33	G	G	G	J	J	J	J	J	J	J	J						
390	39	G	G	G	J	J	J	J	J	J	J	J						
470	47	G	G	G	J	J	J	J	J	J	J	J						
510	51	G	G	G	J	J	J	J	J	J	J	J						
560	56	G	G	G	J	J	J	J	J	J	J	J						
680	68	G	G	G	J	J	J	J	J	J	J	J						
820	82	G	G	G	J	J	J	J	J	J	J	J						
101	100	G	G	G	J	J	J	J	J	J	J	J						
121	120	G	G	G	J	J	J	J	J	J	J	J						
151	150	G	G	G	J	J	J	J	J	J	J	J						
181	180	G	G	G	J	J	J	J	J	J	J	J						
221	220	G	G	G	J	J	J	J	J	J	J	J						
271	270	G	G	G	J	J	J	J	J	J	J	J						
331	330	G	G	G	J	J	J	J	J	J	J	J						
391	390	G	G		J	J	J	J	J	J	J	J						
471	470	G	G		J	J	J	J	J	J	J	J						
561	560				J	J	J	J	J	J	J	J						
681	680				J	J	J	J	J	J	J	J						
821	820				J	J	J	J	J	J	J	J						
102	1000				J	J	J	J	J	J	J	J	J	J	J	J		
122	1200							J	J	J			J	J	M	M		
152	1500							J	M	M			J	J	M	M		
182	1800							J	M	M			J	J	M	M		
222	2200							J	M	M			J	J	M	M		
272	2700							J	M	Q			J	J	M			
332	3300							J	M	Q			J	J	P		K	K
392	3900												J	J	P		K	K
472	4700												J	J	P		K	K
103	10nF																	
		0603			0805			1206					1210				1812	
		25V	50V	100V	25V	50V	100V	25V	50V	100V	200V	500V	25V	50V	100V	200V	50V	100V

Letter	A	C	E	G	J	K	M	N	P	Q	X	Y	Z
Max. Thickness	0.33 (0.013)	0.56 (0.022)	0.71 (0.028)	0.90 (0.035)	0.94 (0.037)	1.02 (0.040)	1.27 (0.050)	1.40 (0.055)	1.52 (0.060)	1.78 (0.070)	2.29 (0.090)	2.54 (0.100)	2.79 (0.110)
	PAPER					EMBOSSSED							

AEC-Q200 qualified  
TS 16949, ISO 9001 certified



# X7R Automotive Plus Series / APS



## Capacitance Range

		0603					0805					1206					1210				1812		2220		
		16V	25V	50V	100V	200V	16V	25V	50V	100V	200V	16V	25V	50V	100V	200V	500V	16V	25V	50V	100V	50V	100V	25V	50V
102	Cap 1	G	G	G	G	G	J	J	J	J	J	J	J	J	J	J	J	K	K	K	K	K	K		
182	(nF) 1.8	G	G	G	G	G	J	J	J	J	J	J	J	J	J	J	J	K	K	K	K	K	K		
222	2.2	G	G	G	G	G	J	J	J	J	J	J	J	J	J	J	J	K	K	K	K	K	K		
332	3.3	G	G	G	G	G	J	J	J	J	J	J	J	J	J	J	J	K	K	K	K	K	K		
472	4.7	G	G	G	G	G	J	J	J	J	J	J	J	J	J	J	J	K	K	K	K	K	K		
103	10	G	G	G	G	G	J	J	J	J	J	J	J	J	J	J	J	K	K	K	K	K	K		
123	12	G	G	G			J	J	J	M		J	J	J	J	J		K	K	K	K	K	K		
153	15	G	G	G			J	J	J	M		J	J	J	J	J		K	K	K	K	K	K		
183	18	G	G	G			J	J	J	M		J	J	J	J	J		K	K	K	K	K	K		
223	22	G	G	G			J	J	J	M		J	J	J	J	J		K	K	K	K	K	K		
273	27	G	G	G			J	J	J	M		J	J	J	J	J		K	K	K	K	K	K		
333	33	G	G	G			J	J	J	M		J	J	J	J	J		K	K	K	K	K	K		
473	47	G	G	G			J	J	J	M		J	J	J	M	J		K	K	K	K	K	K		
563	56	G	G	G			J	J	J	M		J	J	J	M	J		K	K	K	M	K	K		
683	68	G	G	G			J	J	J	M		J	J	J	M	J		K	K	K	M	K	K		
823	82	G	G	G			J	J	J	M		J	J	J	M	J		K	K	K	M	K	K		
104	100	G	G	G			J	J	M	M		J	J	J	M	J		K	K	K	M	K	K		
124	120						J	J	M			J	J	M	M			K	K	K	P	K	K		
154	150						M	N	M			J	J	M	M			K	K	K	P	K	K		
224	220						M	N	M			J	M	M	Q			M	M	M	P	M	M		
334	330						N	N	M			J	M	P	Q			P	P	P	Q	X	X		
474	470						N	N	M			M	M	P	Q			P	P	P	Q	X	X		
684	680						N	N				M	Q	Q	Q			P	P	Q	X	X	X		
105	Cap 1						N	N				M	Q	Q	Q			P	Q	Q	X	X	X		
155	(µF) 1.5											Q	Q					P	Q	Z	Z	X	X		
225	2.2											Q	Q					X	Z	Z	Z	Z	Z		
335	3.3																	X	Z	Z		Z			
475	4.7																	X	Z	Z		Z			
106	10																							Z	
226	22																							Z	Z
		16V	25V	50V	100V	200V	16V	25V	50V	100V	200V	16V	25V	50V	100V	200V	500V	16V	25V	50V	100V	50V	100V	25V	50V
		0603					0805					1206					1210				1812		2220		

= Under Development

Letter	A	C	E	G	J	K	M	N	P	Q	X	Y	Z
Max. Thickness	0.33 (0.013)	0.56 (0.022)	0.71 (0.028)	0.90 (0.035)	0.94 (0.037)	1.02 (0.040)	1.27 (0.050)	1.40 (0.055)	1.52 (0.060)	1.78 (0.070)	2.29 (0.090)	2.54 (0.100)	2.79 (0.110)
	PAPER					EMBOSSSED							

**AEC-Q200 qualified**  
**TS 16949, ISO 9001 certified**

## General Specifications

### GENERAL DESCRIPTION

With increased requirements from the automotive industry for additional component robustness, AVX recognized the need to produce a MLCC with enhanced mechanical strength. It was noted that many components may be subject to severe flexing and vibration when used in various under the hood automotive and other harsh environment applications.

To satisfy the requirement for enhanced mechanical strength, AVX had to find a way of ensuring electrical integrity is maintained whilst external forces are being applied to the component. It was found that the structure of the termination needed to be flexible and after much research and development, AVX launched FLEXITERM®. FLEXITERM® is designed to enhance the mechanical flexure and temperature cycling performance of a standard ceramic capacitor with an X7R dielectric. **The industry standard for flexure is 2mm minimum. Using FLEXITERM®, AVX provides up to 5mm of flexure without internal cracks. Beyond 5mm, the capacitor will generally fail “open”.**

As well as for automotive applications FLEXITERM® will provide Design Engineers with a satisfactory solution when designing PCB's which may be subject to high levels of board flexure.

### PRODUCT ADVANTAGES

- High mechanical performance able to withstand, 5mm bend test guaranteed.
- Increased temperature cycling performance, 3000 cycles and beyond.
- Flexible termination system.
- Reduction in circuit board flex failures.
- Base metal electrode system.
- Automotive or commercial grade products available.

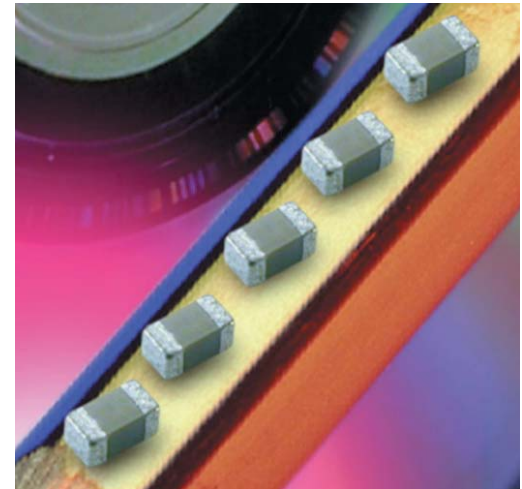

### APPLICATIONS

#### High Flexure Stress Circuit Boards

- e.g. Depanelization: Components near edges of board.

#### Variable Temperature Applications

- Soft termination offers improved reliability performance in applications where there is temperature variation.
- e.g. All kind of engine sensors: Direct connection to battery rail.

#### Automotive Applications

- Improved reliability.
- Excellent mechanical performance and thermo mechanical performance.

### HOW TO ORDER

0805	5	C	104	K	A	Z	2	A
<b>Style</b> 0603 0805 1206 1210 1812 2220	<b>Voltage</b> 6 = 6.3V Z = 10V Y = 16V 3 = 25V 5 = 50V 1 = 100V 2 = 200V	<b>Dielectric</b> C = X7R F = X8R	<b>Capacitance Code (In pF)</b> 2 Sig Digits + Number of Zeros e.g., 104 = 100nF	<b>Capacitance Tolerance</b> J = ±5%* K = ±10% M = ±20%  *≤1µF only	<b>Failure Rate</b> A=Commercial 4 = Automotive	<b>Terminations</b> Z = FLEXITERM® For FLEXITERM® with Tin/Lead termination see AVX LD Series	<b>Packaging</b> 2 = 7" reel 4 = 13" reel	<b>Special Code</b> A = Std. Product

NOTE: Contact factory for availability of Tolerance Options for Specific Part Numbers.

**Not RoHS Compliant**



For RoHS compliant products, please select correct termination style.

## Specifications and Test Methods

### PERFORMANCE TESTING

#### AEC-Q200 Qualification:

- Created by the Automotive Electronics Council
- Specification defining stress test qualification for passive components



#### Testing:

Key tests used to compare soft termination to AEC-Q200 qualification:

- Bend Test
- Temperature Cycle Test

### BOARD BEND TEST RESULTS

AEC-Q200 Vrs AVX FLEXITERM<sup>®</sup> Bend Test

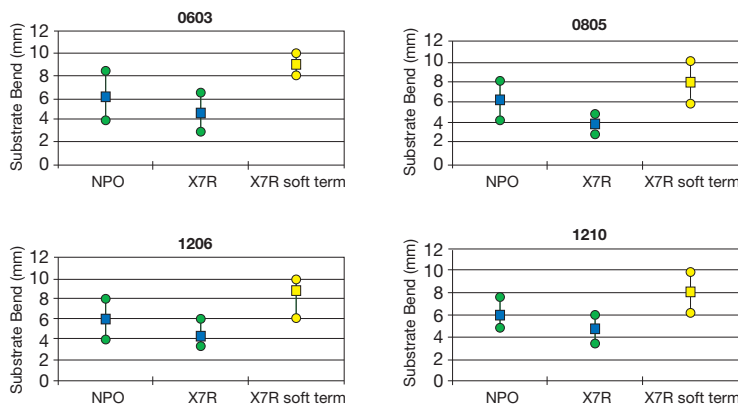

### TABLE SUMMARY

Typical bend test results are shown below:

Style	Conventional Termination	FLEXITERM <sup>®</sup>
0603	>2mm	>5mm
0805	>2mm	>5mm
1206	>2mm	>5mm

### TEMPERATURE CYCLE TEST PROCEDURE

#### Test Procedure as per AEC-Q200:

The test is conducted to determine the resistance of the component when it is exposed to extremes of alternating high and low temperatures.

- Sample lot size quantity 77 pieces
- TC chamber cycle from -55°C to +125°C for 1000 cycles
- Interim electrical measurements at 250, 500, 1000 cycles
- Measure parameter capacitance dissipation factor, insulation resistance

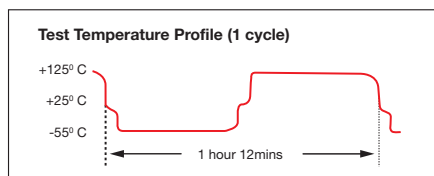

### BOARD BEND TEST PROCEDURE

According to AEC-Q200

Test Procedure as per AEC-Q200:

Sample size: 20 components  
Span: 90mm Minimum deflection spec: 2 mm

- Components soldered onto FR4 PCB (Figure 1)
- Board connected electrically to the test equipment (Figure 2)

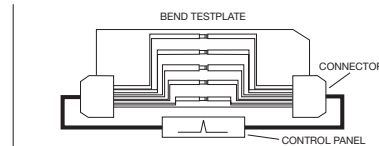

Fig 1 - PCB layout with electrical connections

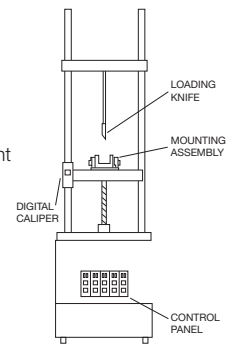
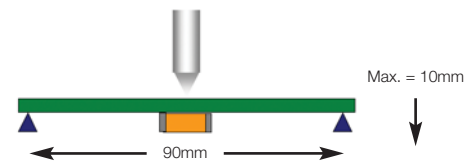

Fig 2 - Board Bend test equipment

### AVX ENHANCED SOFT TERMINATION BEND TEST PROCEDURE

#### Bend Test

The capacitor is soldered to the printed circuit board as shown and is bent up to 10mm at 1 mm per second:



- The board is placed on 2 supports 90mm apart (capacitor side down)
- The row of capacitors is aligned with the load stressing knife



- The load is applied and the deflection where the part starts to crack is recorded (Note: Equipment detects the start of the crack using a highly sensitive current detection circuit)
- The maximum deflection capability is 10mm



### BEYOND 1000 CYCLES: TEMPERATURE CYCLE TEST RESULTS

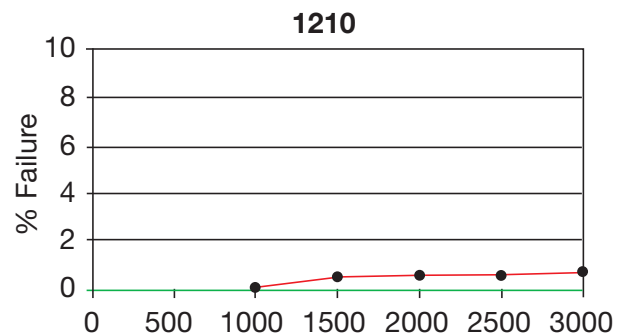
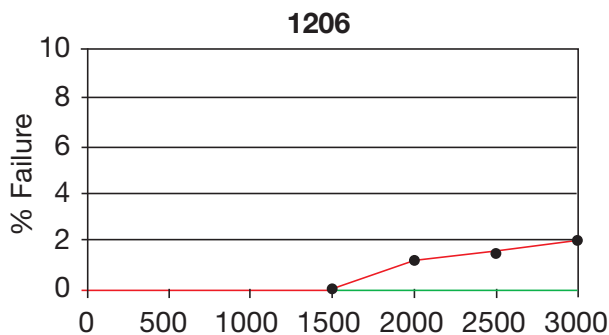
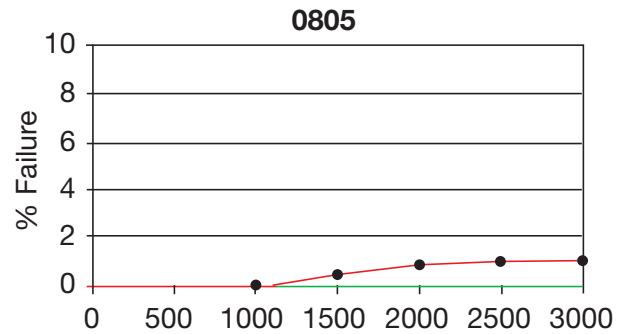
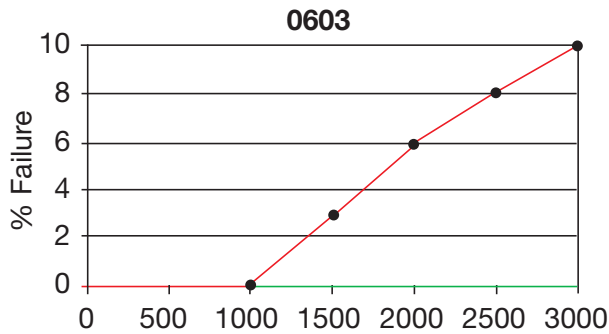

**Soft Term - No Defects up to 3000 cycles**

**AEC-Q200 specification states 1000 cycles compared to AVX 3000 temperature cycles.**

### FLEXITERM® TEST SUMMARY

- Qualified to AEC-Q200 test/specification with the exception of using AVX 3000 temperature cycles (up to +150°C bend test guaranteed greater than 5mm).
- FLEXITERM® provides improved performance compared to standard termination systems.
- Board bend test improvement by a factor of 2 to 4 times.
- Temperature Cycling:
  - 0% Failure up to 3000 cycles
  - No ESR change up to 3000 cycles

### WITHOUT SOFT TERMINATION

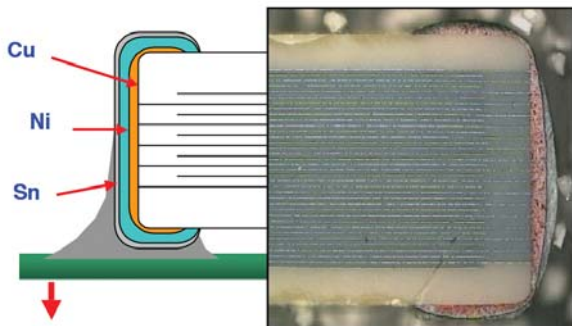

Major fear is of latent board flex failures.

### WITH SOFT TERMINATION

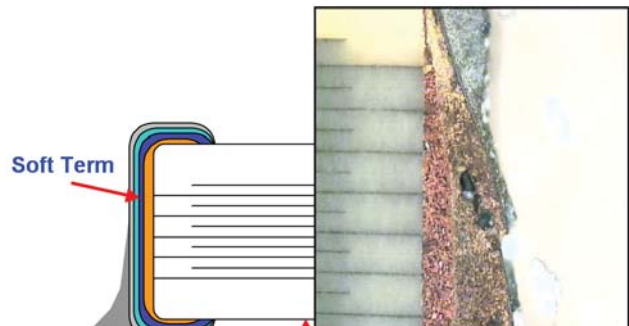

Far superior mechanical performance. Generally open failure mode beyond 5mm flexure.

# MLCC with FLEXITERM®



## X8R Dielectric Capacitance Range

SIZE		0603		0805		1206	
	WVDC	25V	50V	25V	50V	25V	50V
271	Cap	G	G				
331	(pF)	G	G	J	J		
471	470	G	G	J	J		
681	680	G	G	J	J		
102	1000	G	G	J	J	J	J
152	1500	G	G	J	J	J	J
182	1800	G	G	J	J	J	J
222	2200	G	G	J	J	J	J
272	2700	G	G	J	J	J	J
332	3300	G	G	J	J	J	J
392	3900	G	G	J	J	J	J
472	4700	G	G	J	J	J	J
562	5600	G	G	J	J	J	J
682	6800	G	G	J	J	J	J
822	8200	G	G	J	J	J	J
103	Cap	G	G	J	J	J	J
123	(µF)	G	G	J	J	J	J
153	0.015	G	G	J	J	J	J
183	0.018	G	G	J	J	J	J
223	0.022	G	G	J	J	J	J
273	0.027	G	G	J	J	J	J
333	0.033	G	G	J	J	J	J
393	0.039	G	G	J	J	J	J
473	0.047	G	G	J	J	J	J
563	0.056	G		N	N	M	M
683	0.068	G		N	N	M	M
823	0.082			N	N	M	M
104	0.1			N	N	M	M
124	0.12			N	N	M	M
154	0.15			N	N	M	M
184	0.18			N		M	M
224	0.22			N		M	M
274	0.27					M	M
334	0.33					M	M
394	0.39					M	
474	0.47					M	
684	0.68						
824	0.82						
105	1						
	WVDC	25V	50V	25V	50V	25V	50V
SIZE		0603		0805		1206	

Letter	A	C	E	G	J	K	M	N	P	Q	X	Y	Z
Max. Thickness	0.33 (0.013)	0.56 (0.022)	0.71 (0.028)	0.90 (0.035)	0.94 (0.037)	1.02 (0.040)	1.27 (0.050)	1.40 (0.055)	1.52 (0.060)	1.78 (0.070)	2.29 (0.090)	2.54 (0.100)	2.79 (0.110)
	PAPER					EMBOSSED							

= AEC-Q200 Qualified

## X7R Dielectric Capacitance Range

	0603					0805					1206					1210				1812				2220				
	16V	25V	50V	100V	200V	10V	16V	25V	50V	100V	200V	16V	25V	50V	100V	200V	16V	25V	50V	100V	16V	25V	50V	100V	25V	50V	100V	
101																												
121																												
151																												
181																												
221																												
271	J	J	J	J	J	J																						
331	J	J	J	J	J	J	J	J	J	J	J																	
391	J	J	J	J	J	J	J	J	J	J	J																	
471	J	J	J	J	J	J	J	J	J	J	J																	
561	J	J	J	J	J	J	J	J	J	J	J																	
681	J	J	J	J	J	J	J	J	J	J	J																	
821	J	J	J	J	J	J	J	J	J	J	J																	
102	J	J	J	J	J	J	J	J	J	J	J	J	J	J	J													
122	J	J	J	J		J	J	J	J	J	J	J	J	J	J													
152	J	J	J	J		J	J	J	J	J	J	J	J	J	J													
182	J	J	J	J		J	J	J	J	J	J	J	J	J	J													
222	J	J	J	J		J	J	J	J	J	J	J	J	J	J													
272	J	J	J	J		J	J	J	J	J	J	J	J	J	J													
332	J	J	J	J		J	J	J	J	J	J	J	J	J	J													
392	J	J	J	J		J	J	J	J	J	J	J	J	J	J													
472	J	J	J	J		J	J	J	J	J	J	J	J	J	J													
562	J	J	J	J		J	J	J	J	J	J	J	J	J	J													
682	J	J	J	J		J	J	J	J	J	J	J	J	J	J													
822	J	J	J	J		J	J	J	J	J	J	J	J	J	J													
103	J	J	J	J		J	J	J	J	J	J	J	J	J	J													
123	J	J	J			J	J	J	J	M																		
153	J	J	J			J	J	J	J	M																		
183	J	J	J			J	J	J	J	M																		
223	J	J	J			J	J	J	J	M																		
273	J	J	J			J	J	J	J	M																		
333	J	J	J			J	J	J	J	M																		
393	J	J	J			J	J	J	J	M																		
473	J	J	J			J	J	J	J	M																		
563	J	J	J			J	J	J	J	N																		
683	J	J	J			J	J	J	J	N																		
823	J	J	J			J	J	J	J	N																		
104	J	J	J			J	J	J	J	N																		
124						J	J	J	N	N																		
154						M	M	N	N	N																		
184						M	M	N	N	N																		
224						M	M	N	N	N																		
274						N	N	N	N	N																		
334						N	N	N	N	N																		
394						N	N	N	N	N																		
474						N	N	N	N	N																		
564						N	N	N																				
684						N	N	N																				
824						N	N	N																				
105						N	N	N																				
155																												
185																												
225																												
335																												
475																												
106																												
226																												
	16V	25V	50V	100V	200V	10V	16V	25V	50V	100V	200V	16V	25V	50V	100V	200V	16V	25V	50V	100V	16V	25V	50V	100V	25V	50V	100V	
	<b>0603</b>					<b>0805</b>					<b>1206</b>					<b>1210</b>				<b>1812</b>				<b>2220</b>				

Letter	A	C	E	G	J	K	M	N	P	Q	X	Y	Z
Max. Thickness	0.33 (0.013)	0.56 (0.022)	0.71 (0.028)	0.90 (0.035)	0.94 (0.037)	1.02 (0.040)	1.27 (0.050)	1.40 (0.055)	1.52 (0.060)	1.78 (0.070)	2.29 (0.090)	2.54 (0.100)	2.79 (0.110)
	PAPER					EMBOSSSED							

# FLEXISAFE MLC Chips



## For Ultra Safety Critical Applications



AVX have developed a range of components specifically for safety critical applications.

Utilizing the award-winning FLEXITERM™ layer in conjunction with the cascade design previously used for high voltage MLCCs, a range of ceramic capacitors is now available for customers who require components designed with an industry leading set of safety features.

The FLEXITERM™ layer protects the component from any damage to the ceramic resulting from mechanical stress during PCB assembly or use with end customers. Board flexure type mechanical damage accounts for the majority of MLCC failures. The addition of the cascade structure protects the component from low insulation resistance failure resulting from other common causes for failure; thermal stress damage, repetitive strike ESD damage and placement damage. With the inclusion of the cascade design structure to complement the FLEXITERM™ layer, the FLEXISAFE range of capacitors has unbeatable safety features.

### HOW TO ORDER

<b>FS03</b>	<b>5</b>	<b>C</b>	<b>104</b>	<b>K</b>	<b>Q</b>	<b>Z</b>	<b>2</b>	<b>A</b>
<b>Size</b>	<b>Voltage</b>	<b>Dielectric</b>	<b>Capacitance Code (In pF)</b>	<b>Capacitance Tolerance</b>	<b>Failure Rate</b>	<b>Terminations</b>	<b>Packaging</b>	<b>Special Code</b>
FS03 = 0603 FS05 = 0805 FS06 = 1206 FS10 = 1210	16V = Y 25V = 3 50V = 5 100V = 1	X7R = C	2 Sig. Digits + Number of Zeros e.g. 10µF=106	J = ±5% K = ±10% M = ±20%	A = Commercial 4 = Automotive Q = APS	Z = FLEXITERM™ X = FLEXITERM™ with 5% min lead	2 = 7" Reel 4 = 13" Reel	A = Std. Product

### FLEXISAFE X7R RANGE

Code	Capacitance nF	0603				0805				1206			1210		
		16	25	50	100	16	25	50	100	16	25	50	16	25	50
102	1														
182	1.8														
222	2.2														
332	3.3														
472	4.7														
103	10														
123	12														
153	15														
183	18														
223	22														
273	27														
333	33														
473	47														
563	56														
683	68														
823	82														
104	100														
124	120														
154	150														
224	220														
334	330														
474	470														

Qualified (Dark Blue) In Qualification (Light Blue)

**Not RoHS Compliant**



For RoHS compliant products,  
please select correct termination style.



## Capacitor Array (IPC)

### BENEFITS OF USING CAPACITOR ARRAYS

AVX capacitor arrays offer designers the opportunity to lower placement costs, increase assembly line output through lower component count per board and to reduce real estate requirements.

#### Reduced Costs

Placement costs are greatly reduced by effectively placing one device instead of four or two. This results in increased throughput and translates into savings on machine time. Inventory levels are lowered and further savings are made on solder materials, etc.

#### Space Saving

Space savings can be quite dramatic when compared to the use of discrete chip capacitors. As an example, the 0508 4-element array offers a space reduction of >40% vs. 4 x 0402 discrete capacitors and of >70% vs. 4 x 0603 discrete capacitors. (This calculation is dependent on the spacing of the discrete components.)

#### Increased Throughput

Assuming that there are 220 passive components placed in a mobile phone:

A reduction in the passive count to 200 (by replacing discrete components with arrays) results in an increase in throughput of approximately 9%.

A reduction of 40 placements increases throughput by 18%.

For high volume users of cap arrays using the very latest placement equipment capable of placing 10 components per second, the increase in throughput can be very significant and can have the overall effect of reducing the number of placement machines required to mount components:

If 120 million 2-element arrays or 40 million 4-element arrays were placed in a year, the requirement for placement equipment would be reduced by one machine.

During a 20Hr operational day a machine places 720K components. Over a working year of 167 days the machine can place approximately 120 million. If 2-element arrays are mounted instead of discrete components, then the number of placements is reduced by a factor of two and in the scenario where 120 million 2-element arrays are placed there is a saving of one pick and place machine.

Smaller volume users can also benefit from replacing discrete components with arrays. The total number of placements is reduced thus creating spare capacity on placement machines. This in turn generates the opportunity to increase overall production output without further investment in new equipment.

#### W2A (0508) Capacitor Arrays

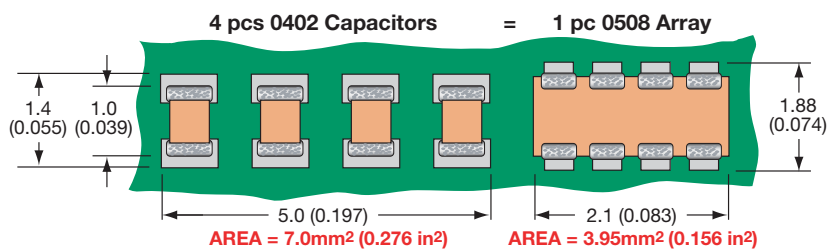

The 0508 4-element capacitor array gives a PCB space saving of over 40% vs four 0402 discretés and over 70% vs four 0603 discrete capacitors.

#### W3A (0612) Capacitor Arrays

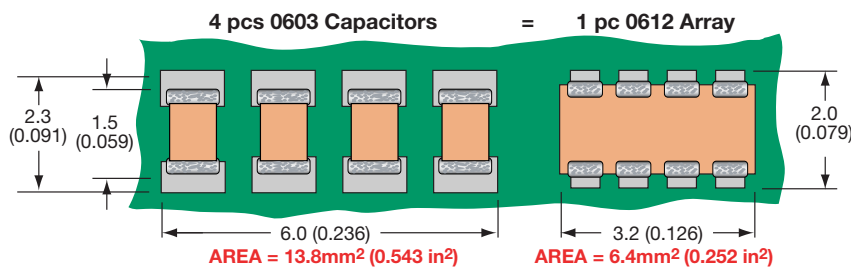

The 0612 4-element capacitor array gives a PCB space saving of over 50% vs four 0603 discretés and over 70% vs four 0805 discrete capacitors.

# Capacitor Array



## Capacitor Array (IPC)

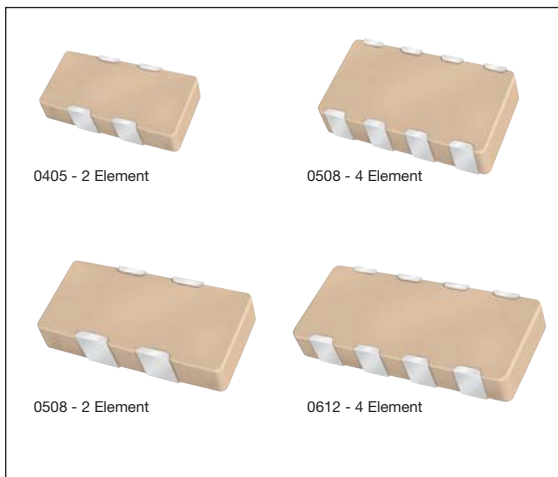

### GENERAL DESCRIPTION

AVX is the market leader in the development and manufacture of capacitor arrays. The smallest array option available from AVX, the 0405 2-element device, has been an enormous success in the Telecommunications market. The array family of products also includes the 0612 4-element device as well as 0508 2-element and 4-element series, all of which have received widespread acceptance in the marketplace.

AVX capacitor arrays are available in X5R, X7R and NP0 (COG) ceramic dielectrics to cover a broad range of capacitance values. Voltage ratings from 6.3 Volts up to 100 Volts are offered. AVX also now offers a range of automotive capacitor arrays qualified to AEC-Q200 (see separate table).

Key markets for capacitor arrays are Mobile and Cordless Phones, Digital Set Top Boxes, Computer Motherboards and Peripherals as well as Automotive applications, RF Modems, Networking Products, etc.

AVX Capacitor Array - W2A41A\*\*\*K  
S21 Magnitude

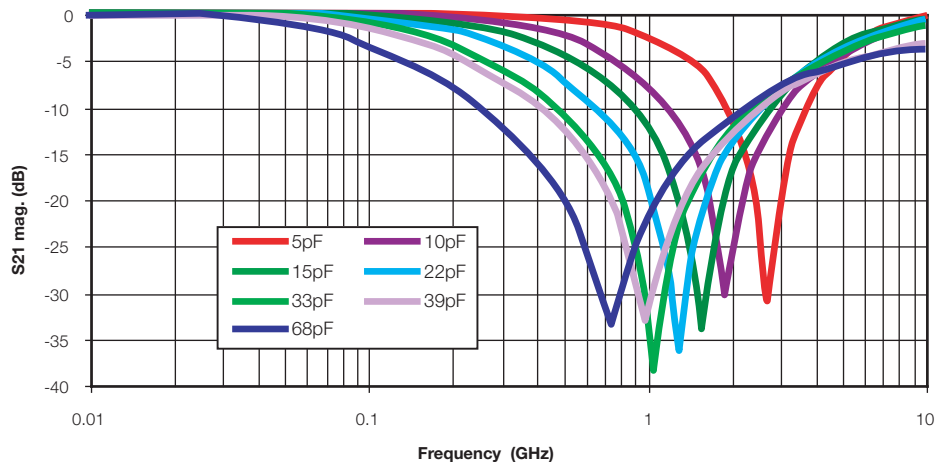

### HOW TO ORDER

<b>W</b>	<b>2</b>	<b>A</b>	<b>4</b>	<b>3</b>	<b>C</b>	<b>103</b>	<b>M</b>	<b>A</b>	<b>T</b>	<b>2A</b>
<b>Style</b> W = RoHS L = SnPb	<b>Case Size</b> 1 = 0405 2 = 0508 3 = 0612 5 = 0306	<b>Array</b>	<b>Number of Caps</b>	<b>Voltage</b> 6 = 6V Z = 10V Y = 16V 3 = 25V 5 = 50V 1 = 100V	<b>Dielectric</b> A = NP0 C = X7R D = X5R	<b>Capacitance Code</b> 2 Sig Digits + Number of Zeros	<b>Capacitance Tolerance</b> J = ±5% K = ±10% M = ±20%	<b>Failure Rate</b> A = Commercial 4 = Automotive	<b>Termination Code</b> T = Plated Ni and Sn** Z = FLEXITERM®** B = 5% min lead X = FLEXITERM® with 5% min lead	<b>Packaging &amp; Quantity Code</b> 2A = 7" Reel (4000) 4A = 13" Reel (10000) 2F = 7" Reel (1000)

**Not RoHS Compliant**

**\*\*RoHS compliant**



NOTE: Contact factory for availability of Termination and Tolerance Options for Specific Part Numbers.

For RoHS compliant products,  
please select correct termination style



# Capacitor Array

## Capacitance Range – NP0/COG

SIZE		0405			0508				0508				0612			
# Elements		2			2				4				4			
Soldering		Reflow Only			Reflow/Wave				Reflow/Wave				Reflow/Wave			
Packaging		All Paper			All Paper				Paper/Embossed				Paper/Embossed			
Length	mm	1.00 ± 0.15			1.30 ± 0.15				1.30 ± 0.15				1.60 ± 0.150			
	(in.)	(0.039 ± 0.006)			(0.051 ± 0.006)				(0.051 ± 0.006)				(0.063 ± 0.006)			
Width	mm	1.37 ± 0.15			2.10 ± 0.15				2.10 ± 0.15				3.20 ± 0.20			
	(in.)	(0.054 ± 0.006)			(0.083 ± 0.006)				(0.083 ± 0.006)				(0.126 ± 0.008)			
Max. Thickness	mm	0.66			0.94				0.94				1.35			
	(in.)	(0.026)			(0.037)				(0.037)				(0.053)			
WVDC		16	25	50	16	25	50	100	16	25	50	100	16	25	50	100
1R0	1.0															
1R2	1.2															
1R5	1.5															
1R8	1.8															
2R2	2.2															
2R7	2.7															
3R3	3.3															
3R9	3.9															
4R7	4.7															
5R6	5.6															
6R8	6.8															
8R2	8.2															
100	10															
120	12															
150	15															
180	18															
220	22															
270	27															
330	33															
390	39															
470	47															
560	56															
680	68															
820	82															
101	100															
121	120															
151	150															
181	180															
221	220															
271	270															
331	330															
391	390															
471	470															
561	560															
681	680															
821	820															
102	1000															
122	1200															
152	1500															
182	1800															
222	2200															
272	2700															
332	3300															
392	3900															
472	4700															
562	5600															
682	6800															
822	8200															

# Capacitor Array



## Capacitance Range – X7R/X5R

SIZE	0306					0405					0508					0508					0612							
# Elements	4					2					2					4					4							
Soldering	Reflow Only					Reflow Only					Reflow/Wave					Reflow/Wave					Reflow/Wave							
Packaging	All Paper					All Paper					All Paper					Paper/Embossed					Paper/Embossed							
Length	mm (in.)	1.60 ± 0.15 (0.063 ± 0.006)				1.00 ± 0.15 (0.039 ± 0.006)				1.30 ± 0.15 (0.051 ± 0.006)				1.30 ± 0.15 (0.051 ± 0.006)				1.60 ± 0.150 (0.063 ± 0.006)										
Width	mm (in.)	0.81 ± 0.15 (0.032 ± 0.006)				1.37 ± 0.15 (0.054 ± 0.006)				2.10 ± 0.15 (0.083 ± 0.006)				2.10 ± 0.15 (0.083 ± 0.006)				3.20 ± 0.20 (0.126 ± 0.008)										
Max. Thickness	mm (in.)	0.50 (0.020)				0.66 (0.026)				0.94 (0.037)				0.94 (0.037)				1.35 (0.053)										
WVDC		6	10	16	25	6	10	16	25	50	6	10	16	25	50	100	6	10	16	25	50	100	6	10	16	25	50	100
101 Cap	100	[Hatched/Orange]																										
121	120																											
151	150																											
181	180	[Brown]																										
221	220																											
271	270																											
331	330	[Brown]																										
391	390																											
471	470																											
561	560	[Brown]																										
681	680																											
821	820																											
102	1000	[Brown]																										
122	1200																											
152	1500																											
182	1800	[Brown]																										
222	2200																											
272	2700																											
332	3300	[Brown]																										
392	3900																											
472	4700																											
562	5600	[Brown]																										
682	6800																											
822	8200																											
103 Cap	0.010	[Brown]																										
123	0.012																											
153	0.015																											
183	0.018	[Brown]																										
223	0.022																											
273	0.027																											
333	0.033	[Brown]																										
393	0.039																											
473	0.047																											
563	0.056	[Hatched/Orange]																										
683	0.068																											
823	0.082																											
104	0.10	[Hatched/Orange]																										
124	0.12																											
154	0.15																											
184	0.18	[Hatched/Orange]																										
224	0.22																											
274	0.27																											
334	0.33	[Hatched/Orange]																										
474	0.47																											
564	0.56																											
684	0.68	[Hatched/Orange]																										
824	0.82																											
105	1.0																											
125	1.2	[Hatched/Orange]																										
155	1.5																											
185	1.8																											
225	2.2	[Hatched/Orange]																										
335	3.3																											
475	4.7																											
106	10	[White]																										
226	22																											
476	47																											
107	100																											

- [Brown] = Currently available X7R
- [Orange] = Currently available X5R
- [Diagonal lines /] = Under development X7R, contact factory for advance samples
- [Hatched/Orange] = Under development X5R, contact factory for advance samples





# Automotive Capacitor Array (IPC)

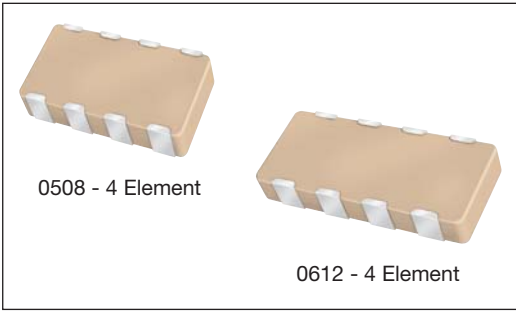

As the market leader in the development and manufacture of capacitor arrays AVX is pleased to offer a range of AEC-Q200 qualified arrays to compliment our product offering to the Automotive industry. Both the AVX 0612 and 0508 4-element capacitor array styles are qualified to the AEC-Q200 automotive specifications.

AEC-Q200 is the Automotive Industry qualification standard and a detailed qualification package is available on request.

All AVX automotive capacitor array production facilities are certified to ISO/TS 16949:2002.

## HOW TO ORDER

**W** | **3** | **A** | **4** | **Y** | **C** | **104** | **K** | **4** | **T** | **2A**

**Style**  
W = RoHS  
L = SnPb

**Case Size**  
1 = 0405  
2 = 0508  
3 = 0612

**Array**

**Number of Caps**

**Voltage**  
Z = 10V  
Y = 16V  
3 = 25V  
5 = 50V  
1 = 100V

**Dielectric**  
A = NP0  
C = X7R  
F = X8R

**Capacitance Code (In pF)**  
Significant Digits + Number of Zeros  
e.g. 10 $\mu$ F=106

**Capacitance Tolerance**  
\*J =  $\pm$ 5%  
\*K =  $\pm$ 10%  
M =  $\pm$ 20%

**Failure Rate**  
4 = Automotive

**Terminations**  
T = Plated Ni and Sn\*\*  
Z = FLEXITERM®\*\*  
B = 5% min lead  
X = FLEXITERM® with 5% min lead

**Packaging & Quantity Code**  
2A = 7" Reel (4000)  
4A = 13" Reel (10000)  
2F = 7" Reel (1000)

**\*\*RoHS compliant**

\*Contact factory for availability by part number for K =  $\pm$ 10% and J =  $\pm$ 5% tolerance.

NP0/COG												
SIZE	0405		0508				0612					
No. of Elements	2	2	4				4					
WVDC	50	50	16	25	50	100	16	25	50	100		
1R0 1R2 1R5	Cap 1.0 (pF) 1.2 1.5											
1R8 2R2 2R7	1.8 2.2 2.7											
3R3 3R9 4R7	3.3 3.9 4.7											
5R6 6R8 8R2	5.6 6.8 8.2											
100 120 150	10 12 15											
180 220 270	18 22 27											
330 390 470	33 39 47											
560 680 820	56 68 82											
101 121 151	100 120 150											
181 221 271	180 220 270											
331 391 471	330 390 470											
561 681 821	560 680 820											
102 122 152	1000 1200 1500											
182 222 272	1800 2200 2700											
332 392 472	3300 3900 4700											
562 682 822	5600 6800 8200											
103 123 153	Cap 0.010 ( $\mu$ F) 0.012 0.015											
183 223 273	0.018 0.022 0.027											
333 393 473	0.033 0.039 0.047											
563 683 823	0.056 0.068 0.082											
104 124 154	0.10 0.12 0.15											
224	0.22											

X7R													X8R	
SIZE	0508				0612				0612				0405	
No. of Elements	2				4				4				2	
WVDC	16	25	50	100	16	25	50	100	10	16	25	50	100	16
101 121 151	Cap 100 (pF) 120 150													
181 221 271	180 220 270													
331 391 471	330 390 470													
561 681 821	560 680 820													
102 122 152	1000 1200 1500													
182 222 272	1800 2200 2700													
332 392 472	3300 3900 4700													
562 682 822	5600 6800 8200													
103 123 153	Cap 0.010 ( $\mu$ F) 0.012 0.015													
183 223 273	0.018 0.022 0.027													
333 393 473	0.033 0.039 0.047													
563 683 823	0.056 0.068 0.082													
104 124 154	0.10 0.12 0.15													
224	0.22													

- = X7R
- = X8R
- = Under development

Not RoHS Compliant



For RoHS compliant products,  
please select correct termination style.



## PART & PAD LAYOUT DIMENSIONS

millimeters (inches)

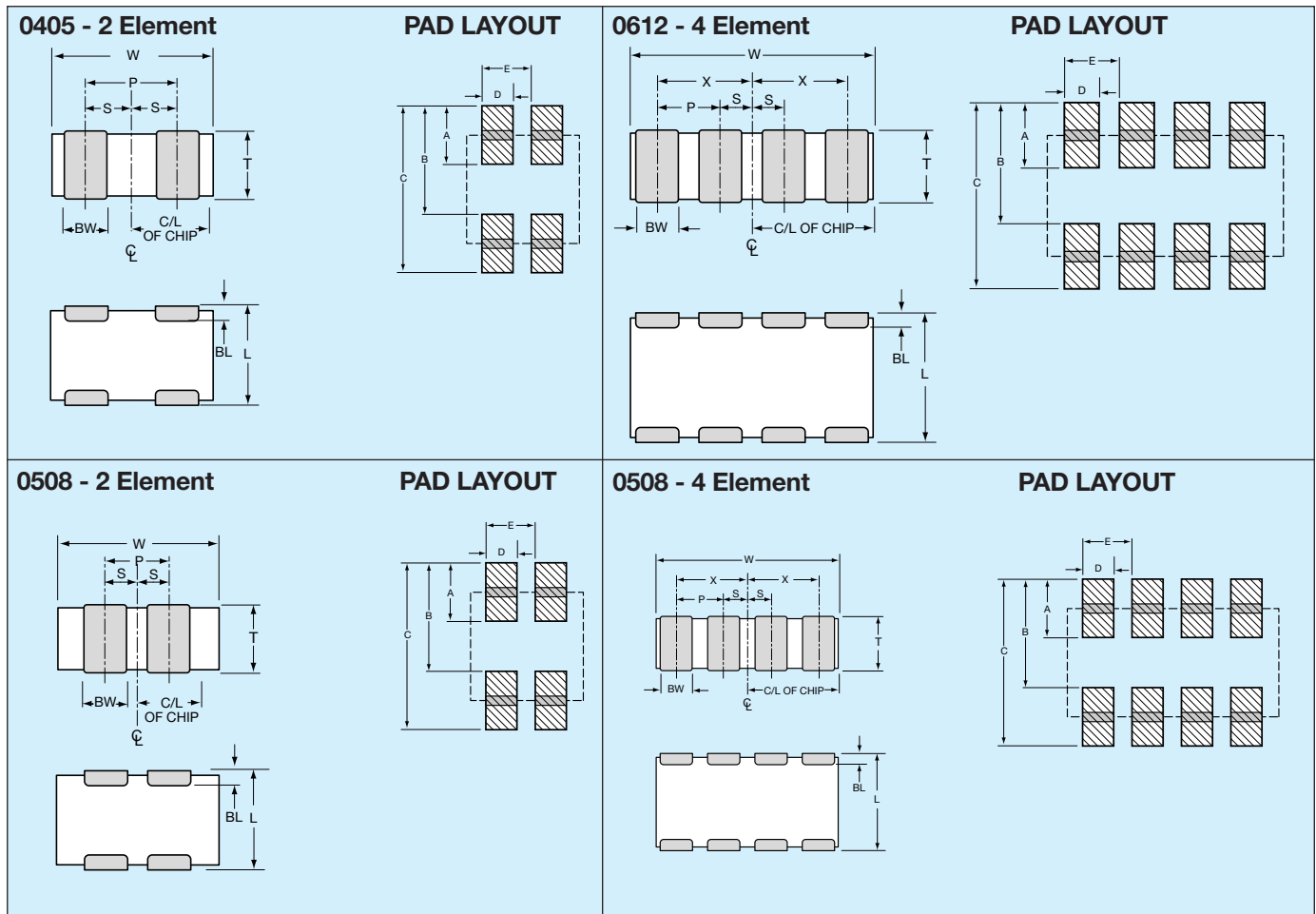

### PART DIMENSIONS

#### 0405 - 2 Element

L	W	T	BW	BL	P	S
1.00 ± 0.15 (0.039 ± 0.006)	1.37 ± 0.15 (0.054 ± 0.006)	0.66 MAX (0.026 MAX)	0.36 ± 0.10 (0.014 ± 0.004)	0.20 ± 0.10 (0.008 ± 0.004)	0.64 REF (0.025 REF)	0.32 ± 0.10 (0.013 ± 0.004)

#### 0508 - 2 Element

L	W	T	BW	BL	P	S
1.30 ± 0.15 (0.051 ± 0.006)	2.10 ± 0.15 (0.083 ± 0.006)	0.94 MAX (0.037 MAX)	0.43 ± 0.10 (0.017 ± 0.004)	0.33 ± 0.08 (0.013 ± 0.003)	1.00 REF (0.039 REF)	0.50 ± 0.10 (0.020 ± 0.004)

#### 0508 - 4 Element

L	W	T	BW	BL	P	X	S
1.30 ± 0.15 (0.051 ± 0.006)	2.10 ± 0.15 (0.083 ± 0.006)	0.94 MAX (0.037 MAX)	0.25 ± 0.06 (0.010 ± 0.003)	0.20 ± 0.08 (0.008 ± 0.003)	0.50 REF (0.020 REF)	0.75 ± 0.10 (0.030 ± 0.004)	0.25 ± 0.10 (0.010 ± 0.004)

#### 0612 - 4 Element

L	W	T	BW	BL	P	X	S
1.60 ± 0.20 (0.063 ± 0.008)	3.20 ± 0.20 (0.126 ± 0.008)	1.35 MAX (0.053 MAX)	0.41 ± 0.10 (0.016 ± 0.004)	0.18 <sup>+0.25</sup> <sub>-0.08</sub> (0.007 <sup>+0.010</sup> <sub>-0.003</sub> )	0.76 REF (0.030 REF)	1.14 ± 0.10 (0.045 ± 0.004)	0.38 ± 0.10 (0.015 ± 0.004)

### PAD LAYOUT DIMENSIONS

#### 0405 - 2 Element

A	B	C	D	E
0.46 (0.018)	0.74 (0.029)	1.20 (0.047)	0.30 (0.012)	0.64 (0.025)

#### 0508 - 2 Element

A	B	C	D	E
0.68 (0.027)	1.32 (0.052)	2.00 (0.079)	0.46 (0.018)	1.00 (0.039)

#### 0508 - 4 Element

A	B	C	D	E
0.56 (0.022)	1.32 (0.052)	1.88 (0.074)	0.30 (0.012)	0.50 (0.020)

#### 0612 - 4 Element

A	B	C	D	E
0.89 (0.035)	1.65 (0.065)	2.54 (0.100)	0.46 (0.018)	0.76 (0.030)

## Introduction

The signal integrity characteristics of a Power Delivery Network (PDN) are becoming critical aspects of board level and semiconductor package designs due to higher operating frequencies, larger power demands, and the ever shrinking lower and upper voltage limits around low operating voltages. These power system challenges are coming from mainstream designs with operating frequencies of 300MHz or greater, modest ICs with power demand of 15 watts or more, and operating voltages below 3 volts.

The classic PDN topology is comprised of a series of capacitor stages. Figure 1 is an example of this architecture with multiple capacitor stages.

An ideal capacitor can transfer all its stored energy to a load instantly. A real capacitor has parasitics that prevent instantaneous transfer of a capacitor's stored energy. The true nature of a capacitor can be modeled as an RLC equivalent circuit. For most simulation purposes, it is possible to model the characteristics of a real capacitor with one

capacitor, one resistor, and one inductor. The RLC values in this model are commonly referred to as equivalent series capacitance (ESC), equivalent series resistance (ESR), and equivalent series inductance (ESL).

The ESL of a capacitor determines the speed of energy transfer to a load. The lower the ESL of a capacitor, the faster that energy can be transferred to a load. Historically, there has been a tradeoff between energy storage (capacitance) and inductance (speed of energy delivery). Low ESL devices typically have low capacitance. Likewise, higher capacitance devices typically have higher ESLs. This tradeoff between ESL (speed of energy delivery) and capacitance (energy storage) drives the PDN design topology that places the fastest low ESL capacitors as close to the load as possible. Low Inductance MLCCs are found on semiconductor packages and on boards as close as possible to the load.

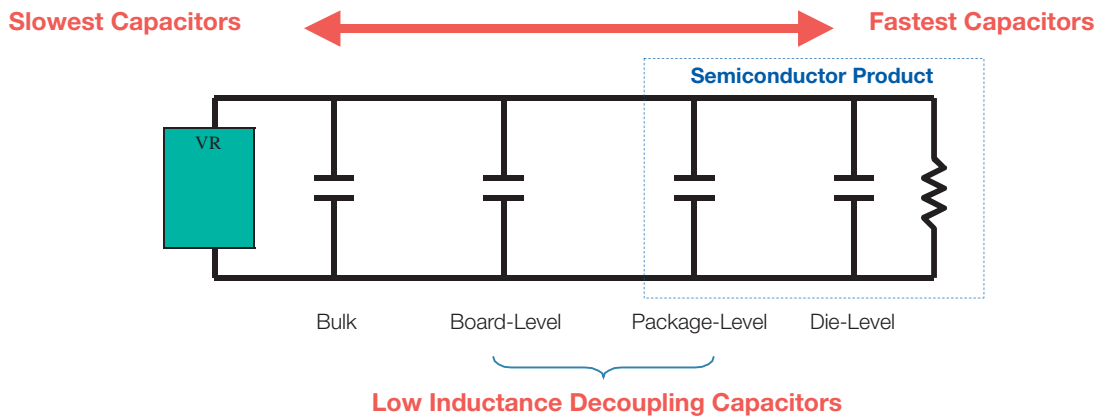

Figure 1 Classic Power Delivery Network (PDN) Architecture

## LOW INDUCTANCE CHIP CAPACITORS

The key physical characteristic determining equivalent series inductance (ESL) of a capacitor is the size of the current loop it creates. The smaller the current loop, the lower the ESL. A standard surface mount MLCC is rectangular in shape with electrical terminations on its shorter sides. A Low Inductance Chip Capacitor (LICC) sometimes referred to as Reverse Geometry Capacitor (RGC) has its terminations on the longer side of its rectangular shape.

When the distance between terminations is reduced, the size of the current loop is reduced. Since the size of the current loop is the primary driver of inductance, an 0306 with a smaller current loop has significantly lower ESL than an 0603. The reduction in ESL varies by EIA size, however, ESL is typically reduced 60% or more with an LICC versus a standard MLCC.

## INTERDIGITATED CAPACITORS

The size of a current loop has the greatest impact on the ESL characteristics of a surface mount capacitor. There is a secondary method for decreasing the ESL of a capacitor. This secondary method uses adjacent opposing current loops to reduce ESL. The InterDigitated Capacitor (IDC) utilizes both primary and secondary methods of reducing inductance. The IDC architecture shrinks the distance between terminations to minimize the current loop size, then further reduces inductance by creating adjacent opposing current loops.

An IDC is one single capacitor with an internal structure that has been optimized for low ESL. Similar to standard MLCC versus LICCs, the reduction in ESL varies by EIA case size. Typically, for the same EIA size, an IDC delivers an ESL that is at least 80% lower than an MLCC.

## Introduction

### LAND GRID ARRAY (LGA) CAPACITORS

Land Grid Array (LGA) capacitors are based on the first Low ESL MLCC technology created to specifically address the design needs of current day Power Delivery Networks (PDNs). This is the 3rd low inductance capacitor technology developed by AVX. LGA technology provides engineers with new options. The LGA internal structure and manufacturing technology eliminates the historic need for a device to be physically small to create small current loops to minimize inductance.

The first family of LGA products are 2 terminal devices. A 2 terminal 0306 LGA delivers ESL performance that is equal to or better than an 0306 8 terminal IDC. The 2 terminal 0805 LGA delivers ESL performance that approaches the 0508 8 terminal IDC. New designs that would have used 8 terminal IDCs are moving to 2 terminal LGAs because the layout is easier for a 2 terminal device and manufacturing yield is better for a 2 terminal LGA versus an 8 terminal IDC.

LGA technology is also used in a 4 terminal family of products that AVX is sampling and will formerly introduce in 2008. Beyond 2008, there are new multi-terminal LGA product families that will provide even more attractive options for PDN designers.

### LOW INDUCTANCE CHIP ARRAYS (LICA®)

The LICA® product family is the result of a joint development effort between AVX and IBM to develop a high performance MLCC family of decoupling capacitors. LICA was introduced in the 1980s and remains the leading choice of designers in high performance semiconductor packages and high reliability board level decoupling applications.

LICA® products are used in 99.999% uptime semiconductor package applications on both ceramic and organic substrates. The C4 solder ball termination option is the perfect compliment to flip-chip packaging technology. Mainframe class CPUs, ultimate performance multi-chip modules, and communications systems that must have the reliability of 5 9's use LICA®.

LICA® products with either Sn/Pb or Pb-free solder balls are used for decoupling in high reliability military and aerospace applications. These LICA® devices are used for decoupling of large pin count FPGAs, ASICs, CPUs, and other high power ICs with low operating voltages.

When high reliability decoupling applications require the very lowest ESL capacitors, LICA® products are the best option.

470 nF 0306 Impedance Comparison

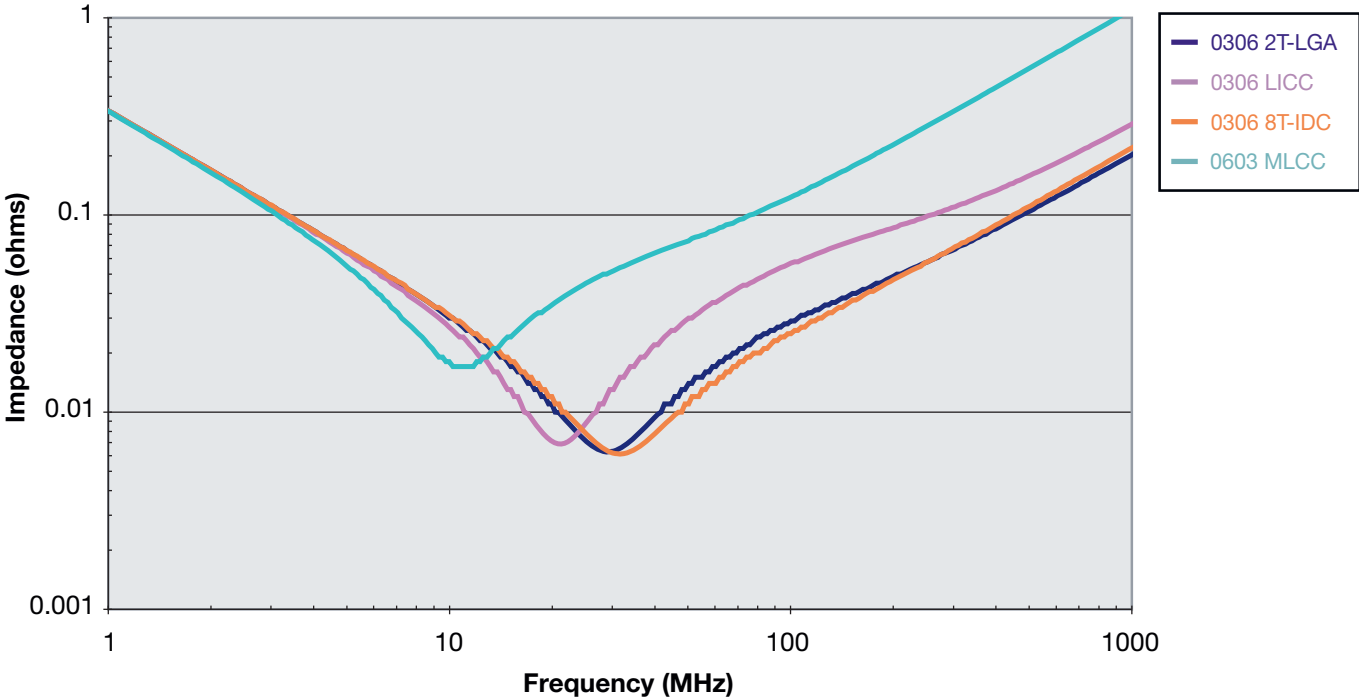

Figure 2 MLCC, LICC, IDC, and LGA technologies deliver different levels of equivalent series inductance (ESL).

# Low Inductance Capacitors (RoHS)



## 0612/0508/0306/0204 LICC (Low Inductance Chip Capacitors)

### GENERAL DESCRIPTION

The key physical characteristic determining equivalent series inductance (ESL) of a capacitor is the size of the current loop it creates. The smaller the current loop, the lower the ESL.

A standard surface mount MLCC is rectangular in shape with electrical terminations on its shorter sides. A Low Inductance Chip Capacitor (LICC) sometimes referred to as Reverse Geometry Capacitor (RGC) has its terminations on the longer sides of its rectangular shape. The image on the right shows the termination differences between an MLCC and an LICC.

When the distance between terminations is reduced, the size of the current loop is reduced. Since the size of the current loop is the primary driver of inductance, an 0306 with a smaller current loop has significantly lower ESL than an 0603. The reduction in ESL varies by EIA size, however, ESL is typically reduced 60% or more with an LICC versus a standard MLCC.

AVX LICC products are available with a lead-free finish of plated Nickel/Tin.

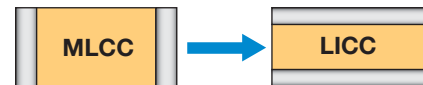
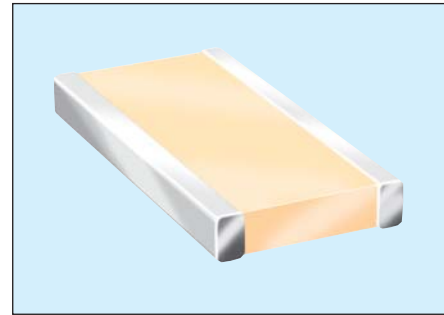

### PERFORMANCE CHARACTERISTICS

<b>Capacitance Tolerances</b>	K = $\pm 10\%$ ; M = $\pm 20\%$
<b>Operation Temperature Range</b>	X7R = $-55^{\circ}\text{C}$ to $+125^{\circ}\text{C}$ X5R = $-55^{\circ}\text{C}$ to $+85^{\circ}\text{C}$ X7S = $-55^{\circ}\text{C}$ to $+125^{\circ}\text{C}$
<b>Temperature Coefficient</b>	X7R, X5R = $\pm 15\%$ ; X7S = $\pm 22\%$
<b>Voltage Ratings</b>	4, 6.3, 10, 16, 25 VDC
<b>Dissipation Factor</b>	4V, 6.3V = 6.5% max; 10V = 5.0% max; 16V = 3.5% max; 25V = 3.0% max
<b>Insulation Resistance (@+25°C, RVDC)</b>	100,000M $\Omega$ min, or 1,000M $\Omega$ per $\mu\text{F}$ min., whichever is less



### HOW TO ORDER

**0612**

**Size**  
0204  
0306  
0508  
0612

**Z**

**Voltage**  
4 = 4V  
6 = 6.3V  
Z = 10V  
Y = 16V  
3 = 25V  
5 = 50V

**D**

**Dielectric**  
C = X7R  
D = X5R  
W = X6S  
Z = X7S

**105**

**Capacitance Code (In pF)**  
2 Sig. Digits +  
Number of Zeros

**M**

**Capacitance Tolerance**  
K =  $\pm 10\%$   
M =  $\pm 20\%$

**A**

**Failure Rate**  
A = N/A

**T**

**Terminations**  
T = Plated Ni  
and Sn

**2**

**Packaging Available**  
2 = 7" Reel  
4 = 13" Reel

**A\***

**Thickness**  
Thickness  
mm (in)  
0.35 (0.014)  
0.56 (0.022)  
0.61 (0.024)  
0.76 (0.030)  
1.02 (0.040)  
1.27 (0.050)

NOTE: Contact factory for availability of Termination and Tolerance Options for Specific Part Numbers.

### TYPICAL IMPEDANCE CHARACTERISTICS

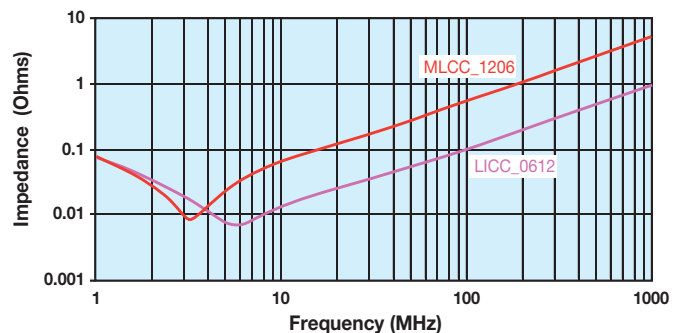
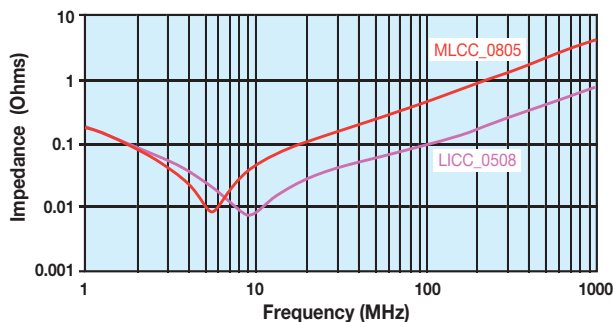

# Low Inductance Capacitors (RoHS)



## 0612/0508/0306/0204 LICC (Low Inductance Chip Capacitors)

SIZE	0204				0306					0508					0612														
Packaging															Embossed					Embossed					Embossed				
Length mm (in.)															0.81 ± 0.15 (0.032 ± 0.006)					1.27 ± 0.25 (0.050 ± 0.010)					1.60 ± 0.25 (0.063 ± 0.010)				
Width mm (in.)															1.60 ± 0.15 (0.063 ± 0.006)					2.00 ± 0.25 (0.080 ± 0.010)					3.20 ± 0.25 (0.126 ± 0.010)				
WVDC	4	6.3	10	16	4	6.3	10	16	25	50	6.3	10	16	25	50	6.3	10	16	25	50									
CAP 0.001 (µF)																													
0.0022																													
0.0047																													
0.010																													
0.015																													
0.022																													
0.047																													
0.068																													
0.10																													
0.15																													
0.22																													
0.47																													
0.68																													
1.0																													
1.5																													
2.2																													
3.3																													
4.7																													
10																													

### PHYSICAL DIMENSIONS AND PAD LAYOUT

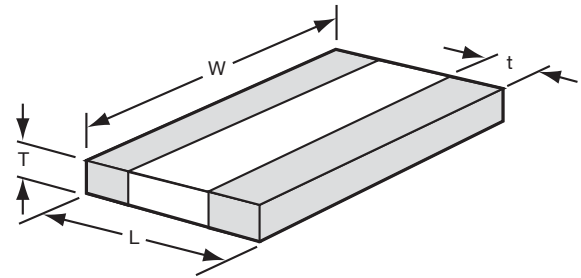

### PHYSICAL CHIP DIMENSIONS mm (in)

	L	W	t
<b>0612</b>	1.60 ± 0.25 (0.063 ± 0.010)	3.20 ± 0.25 (0.126 ± 0.010)	0.13 min. (0.005 min.)
<b>0508</b>	1.27 ± 0.25 (0.050 ± 0.010)	2.00 ± 0.25 (0.080 ± 0.010)	0.13 min. (0.005 min.)
<b>0306</b>	0.81 ± 0.15 (0.032 ± 0.006)	1.60 ± 0.15 (0.063 ± 0.006)	0.13 min. (0.005 min.)
<b>0204</b>	0.50 ± 0.05 (0.020 ± 0.002)	1.00 ± 0.05 (0.040 ± 0.002)	0.18 ± 0.08 (0.007 ± 0.003)

T - See Range Chart for Thickness and Codes

### PAD LAYOUT DIMENSIONS mm (in)

	A	B	C
0612	0.76 (0.030)	3.05 (0.120)	.635 (0.025)
0508	0.51 (0.020)	2.03 (0.080)	0.51 (0.020)
0306	0.31 (0.012)	1.52 (0.060)	0.51 (0.020)
0204			

Solid = X7R		Diagonal lines = X5R		Vertical lines = X7S		Horizontal lines = X6S	
mm (in.)		mm (in.)		mm (in.)		mm (in.)	
<b>0204</b>		<b>0306</b>		<b>0508</b>		<b>0612</b>	
<b>Code</b>	<b>Thickness</b>	<b>Code</b>	<b>Thickness</b>	<b>Code</b>	<b>Thickness</b>	<b>Code</b>	<b>Thickness</b>
<b>C</b>	0.35 (0.014)	<b>A</b>	0.61 (0.024)	<b>S</b>	0.56 (0.022)	<b>S</b>	0.56 (0.022)
				<b>V</b>	0.76 (0.030)	<b>V</b>	0.76 (0.030)
				<b>A</b>	1.02 (0.040)	<b>W</b>	1.02 (0.040)
						<b>A</b>	1.27 (0.050)

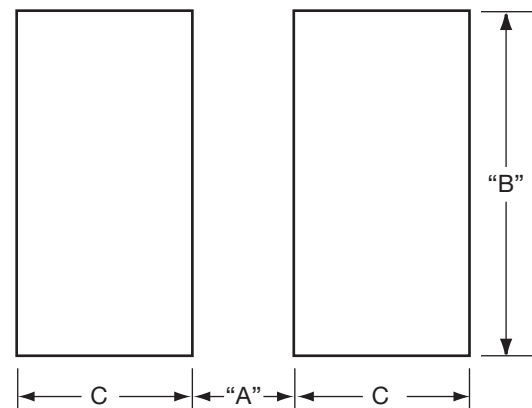

# Low Inductance Capacitors (SnPb)



0612/0508/0306/0204 Tin Lead Termination "B"

## GENERAL DESCRIPTION

The key physical characteristic determining equivalent series inductance (ESL) of a capacitor is the size of the current loop it creates. The smaller the current loop, the lower the ESL.

A standard surface mount MLCC is rectangular in shape with electrical terminations on its shorter sides. A Low Inductance Chip Capacitor (LICC) sometimes referred to as Reverse Geometry Capacitor (RGC) has its terminations on the longer sides of its rectangular shape. The image on the right shows the termination differences between an MLCC and an LICC.

When the distance between terminations is reduced, the size of the current loop is reduced. Since the size of the current loop is the primary driver of inductance, an 0306 with a smaller current loop has significantly lower ESL than an 0603. The reduction in ESL varies by EIA size, however, ESL is typically reduced 60% or more with an LICC versus a standard MLCC.

AVX LICC products are available with a lead termination for high reliability military and aerospace applications that must avoid tin whisker reliability issues.

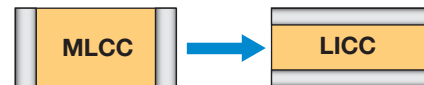
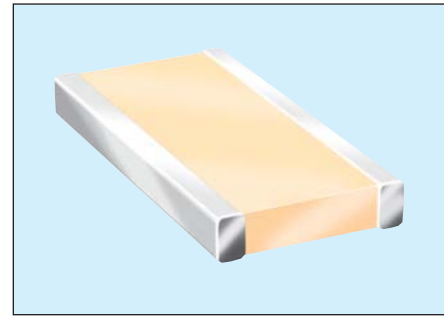

## PERFORMANCE CHARACTERISTICS

<b>Capacitance Tolerances</b>	K = $\pm 10\%$ ; M = $\pm 20\%$
<b>Operation Temperature Range</b>	X7R = $-55^{\circ}\text{C}$ to $+125^{\circ}\text{C}$ X5R = $-55^{\circ}\text{C}$ to $+85^{\circ}\text{C}$ X7S = $-55^{\circ}\text{C}$ to $+125^{\circ}\text{C}$
<b>Temperature Coefficient</b>	X7R, X5R = $\pm 15\%$ ; X7S = $\pm 22\%$
<b>Voltage Ratings</b>	4, 6.3, 10, 16, 25 VDC
<b>Dissipation Factor</b>	4V, 6.3V = 6.5% max; 10V = 5.0% max; 16V = 3.5% max; 25V = 3.0% max
<b>Insulation Resistance (@+25°C, RVDC)</b>	100,000M $\Omega$ min, or 1,000M $\Omega$ per $\mu\text{F}$ min., whichever is less

**Not RoHS Compliant**

## HOW TO ORDER

<b>LD18</b>	<b>Z</b>	<b>D</b>	<b>105</b>	<b>M</b>	<b>A</b>	<b>B</b>	<b>2</b>	<b>A*</b>
<b>Size</b>	<b>Voltage</b>	<b>Dielectric</b>	<b>Capacitance Code (In pF)</b>	<b>Capacitance Tolerance</b>	<b>Failure Rate</b>	<b>Terminations</b>	<b>Packaging Available</b>	<b>Thickness</b>
LD15 = 0204 LD16 = 0306 LD17 = 0508 LD18 = 0612	4 = 4V 6 = 6.3V Z = 10V Y = 16V 3 = 25V 5 = 50V	C = X7R D = X5R W = X6S	2 Sig. Digits + Number of Zeros	K = $\pm 10\%$ M = $\pm 20\%$	A = N/A	B = 5% min lead	2 = 7" Reel 4 = 13" Reel	mm (in) 0.35 (0.014) 0.56 (0.022) 0.61 (0.024) 0.76 (0.030) 1.02 (0.040) 1.27 (0.050)

NOTE: Contact factory for availability of Termination and Tolerance Options for Specific Part Numbers.

## TYPICAL IMPEDANCE CHARACTERISTICS

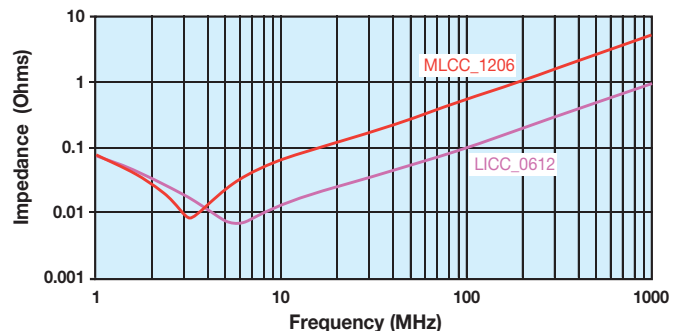
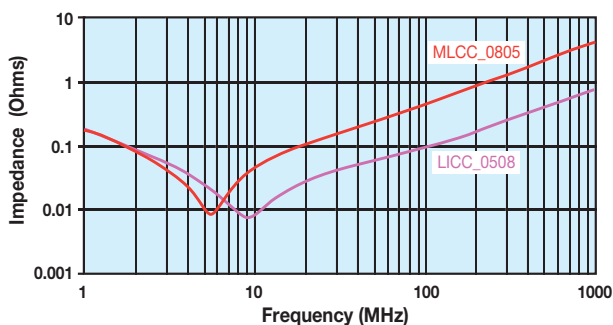

# Low Inductance Capacitors (SnPb)



0612/0508/0306/0204 Tin Lead Termination "B"

## PREFERRED SIZES ARE SHADED

SIZE	LD15				LD16				LD17				LD18						
Soldering					Reflow Only				Reflow Only				Reflow/Wave						
Packaging					All Paper				All Paper				Paper/Embossed						
(L) Length mm (in.)					0.81 ± 0.15 (0.032 ± 0.006)				1.27 ± 0.25 (0.050 ± 0.010)				1.60 ± 0.25 (0.063 ± 0.010)						
(W) Width mm (in.)					1.60 ± 0.15 (0.063 ± 0.006)				2.00 ± 0.25 (0.080 ± 0.010)				3.20 ± 0.25 (0.126 ± 0.010)						
WVDC	4	6.3	10	16	6.3	10	16	25	50	6.3	10	16	25	50	6.3	10	16	25	50
Cap (pF)	1000				A	A	A	A		S	S	S	S	V	S	S	S	S	V
	2200				A	A	A	A		S	S	S	S	V	S	S	S	S	V
	4700				A	A	A	A		S	S	S	S	V	S	S	S	S	V
Cap (µF)	0.010				A	A	A	A		S	S	S	S	V	S	S	S	S	V
	0.015				A	A	A	A		S	S	S	S	V	S	S	S	S	V
	0.022				A	A	A	A		S	S	S	S	V	S	S	S	S	V
	0.047				A	A	A		S	S	S	V	A	A	S	S	S	S	V
	0.068				A	A	A		S	S	S	V	A	A	S	S	S	V	W
	0.10	C	C		A	A	A		S	S	S	V	A	A	S	S	S	V	W
	0.15				A	A			S	S	V			S	S	S	V	W	W
	0.22				A	A			S	S	V	A		S	S	S	V	W	W
	0.47								V	V	A			S	S	V			
	0.68								A	A				V	V	W	A		
	1.0								A	A				V	V	W	A		
	1.5								A	A				W	W				
	2.2													A	A				
	3.3																		
	4.7																		
	10																		
WVDC	4	6.3	10	16	6.3	10	16	25	50	6.3	10	16	25	50	6.3	10	16	25	50
SIZE	<b>0204</b>				<b>0306</b>				<b>0508</b>				<b>0612</b>						

Solid = X7R    = X5R    = X7S    = X6S

mm (in.)		mm (in.)		mm (in.)		mm (in.)	
LD15 - 0204		LD16 - 0306		LD17 - 0508		LD18 - 0612	
Code	Thickness	Code	Thickness	Code	Thickness	Code	Thickness
C	0.35 (0.014)	A	0.61 (0.024)	S	0.56 (0.022)	S	0.56 (0.022)
				V	0.76 (0.030)	V	0.76 (0.030)
				A	1.02 (0.040)	W	1.02 (0.040)
						A	1.27 (0.050)

## PHYSICAL DIMENSIONS AND PAD LAYOUT

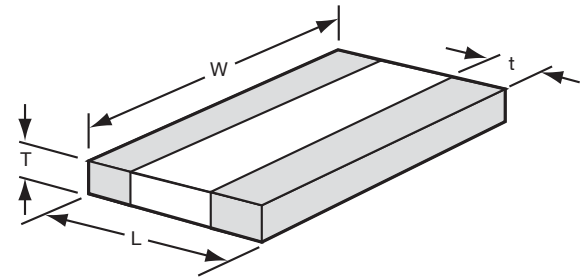

## PHYSICAL CHIP DIMENSIONS mm (in)

	L	W	t
0612	1.60 ± 0.25 (0.063 ± 0.010)	3.20 ± 0.25 (0.126 ± 0.010)	0.13 min. (0.005 min.)
0508	1.27 ± 0.25 (0.050 ± 0.010)	2.00 ± 0.25 (0.080 ± 0.010)	0.13 min. (0.005 min.)
0306	0.81 ± 0.15 (0.032 ± 0.006)	1.60 ± 0.15 (0.063 ± 0.006)	0.13 min. (0.005 min.)
0204	0.50 ± 0.05 (0.020 ± 0.002)	1.00 ± 0.05 (0.040 ± 0.002)	0.18 ± 0.08 (0.007 ± 0.003)

T - See Range Chart for Thickness and Codes

## PAD LAYOUT DIMENSIONS mm (in)

	A	B	C
0612	0.76 (0.030)	3.05 (0.120)	.635 (0.025)
0508	0.51 (0.020)	2.03 (0.080)	0.51 (0.020)
0306	0.31 (0.012)	1.52 (0.060)	0.51 (0.020)
0204			

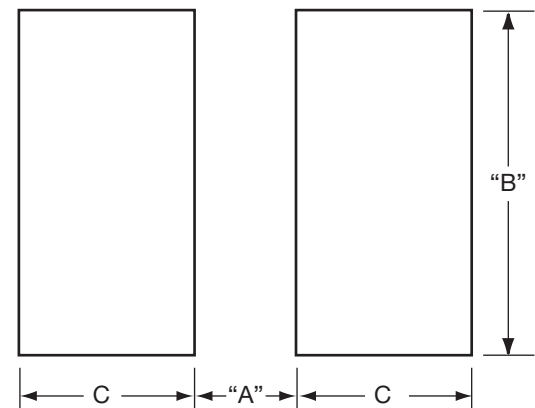



# IDC Low Inductance Capacitors (RoHS)

## 0306/0612/0508 IDC (InterDigitated Capacitors)

### GENERAL DESCRIPTION

Inter-Digitated Capacitors (IDCs) are used for both semiconductor package and board level decoupling. The equivalent series inductance (ESL) of a single capacitor or an array of capacitors in parallel determines the response time of a Power Delivery Network (PDN). The lower the ESL of a PDN, the faster the response time. A designer can use many standard MLCCs in parallel to reduce ESL or a low ESL Inter-Digitated Capacitor (IDC) device. These IDC devices are available in versions with a maximum height of 0.95mm or 0.55mm.

IDCs are typically used on packages of semiconductor products with power levels of 15 watts or greater. Inter-Digitated Capacitors are used on CPU, GPU, ASIC, and ASSP devices produced on 0.13μ, 90nm, 65nm, and 45nm processes. IDC devices are used on both ceramic and organic package substrates. These low ESL surface mount capacitors can be placed on the bottom side or the top side of a package substrate. The low profile 0.55mm maximum height IDCs can easily be used on the bottom side of BGA packages or on the die side of packages under a heat spreader.

IDCs are used for board level decoupling of systems with speeds of 300MHz or greater. Low ESL IDCs free up valuable board space by reducing the number of capacitors required versus standard MLCCs. There are additional benefits to reducing the number of capacitors beyond saving board space including higher reliability from a reduction in the number of components and lower placement costs based on the need for fewer capacitors.

The Inter-Digitated Capacitor (IDC) technology was developed by AVX. This is the second family of Low Inductance MLCC products created by AVX. IDCs are a cost effective alternative to AVX's first generation low ESL family for high-reliability applications known as LICA (Low Inductance Chip Array).

AVX IDC products are available with a lead-free finish of plated Nickel/Tin.

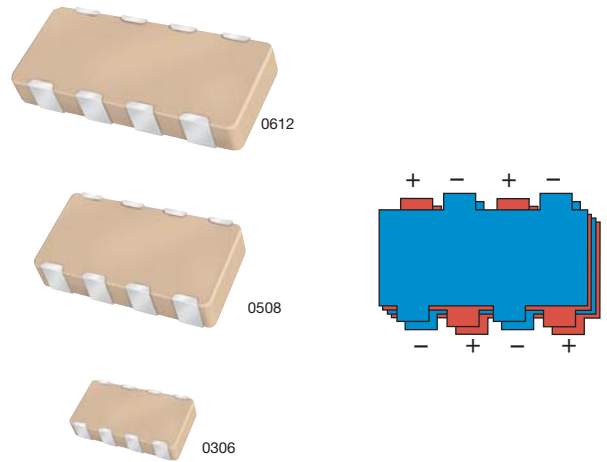

### TYPICAL IMPEDANCE

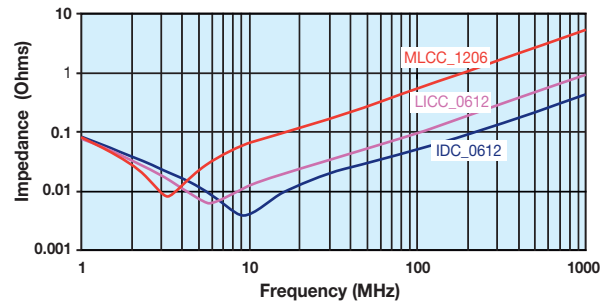

### HOW TO ORDER

W	3	L	1	6	D	225	M	A	T	3	A
Style	IDC Case Size	Low Inductance	Number of Terminals	Voltage	Dielectric	Capacitance Code (In pF)	Capacitance Tolerance	Failure Rate	Termination	Packaging	Thickness
	2 = 0508 3 = 0612 4 = 0306		1 = 8 Terminals	4 = 4V 6 = 6.3V Z = 10V Y = 16V 3 = 25V	C = X7R D = X5R Z = X7S	2 Sig. Digits + Number of Zeros	M = ±20%	A = N/A	T = Plated Ni and Sn	Available 1=7" Reel 3=13" Reel	Max. Thickness mm (in.) A=Standard S=0.55 (0.022)

NOTE: Contact factory for availability of Termination and Tolerance Options for Specific Part Numbers.

### PERFORMANCE CHARACTERISTICS

<b>Capacitance Tolerance</b>	±20% Preferred
<b>Operation Temperature Range</b>	X7R = -55°C to +125°C X5R = -55°C to +85°C X7S = -55°C to +125°C
<b>Temperature Coefficient</b>	±15% (0VDC), ±22% (X7S)
<b>Voltage Ratings</b>	4, 6.3, 10, 16, 25 VDC
<b>Dissipation Factor</b>	≤ 6.3V = 6.5% max; 10V = 5.0% max; ≥ 16V = 3.5% max
<b>Insulation Resistance (@+25°C, RVDC)</b>	100,000MΩ min, or 1,000MΩ per μF min., whichever is less

<b>Dielectric Strength</b>	No problems observed after 2.5 x RVDC for 5 seconds at 50mA max current
<b>CTE (ppm/C)</b>	12.0
<b>Thermal Conductivity</b>	4-5W/M K
<b>Terminations Available</b>	Plated Nickel and Solder

# IDC Low Inductance Capacitors (RoHS)

## 0306/0612/0508 IDC (InterDigitated Capacitors)

SIZE	0306		Thin 0508					0508					Thin 0612				0612					THICK 0612							
Max. Thickness	0.55 (0.022)		0.55 (0.022)					0.95 (0.037)					0.55 (0.022)				0.95 (0.037)					1.22 (0.048)							
WVDC	4	6.3	4	6.3	10	16	25	4	6.3	10	16	25	4	6.3	10	16	4	6.3	10	16	25	4	6.3	10	16	4	6.3	10	16
Cap (μF)	0.010																												
	0.022																												
	0.033																												
	0.047																												
	0.068																												
	0.10																												
	0.22																												
	0.33																												
	0.47																												
	0.68																												
	1.0																												
	1.5																												
	2.2																												
	3.3																												

### PHYSICAL DIMENSIONS AND PAD LAYOUT

Consult factory for additional requirements

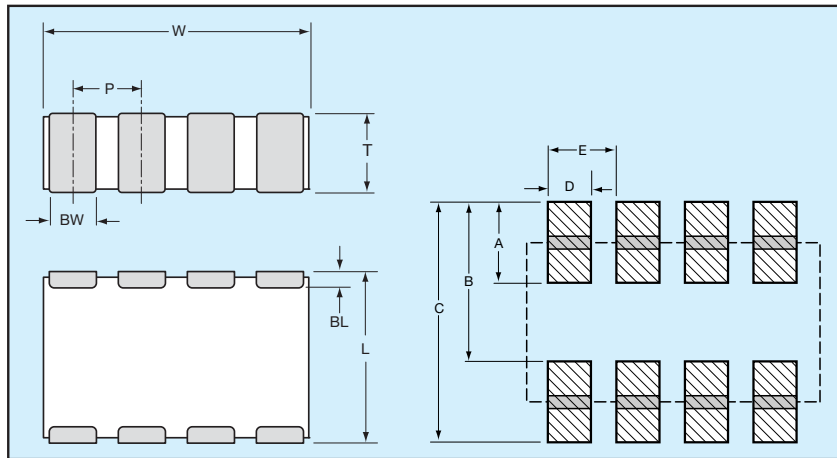

- = X7R
- = X5R
- = X7S

### PHYSICAL CHIP DIMENSIONS millimeters (inches)

SIZE	W	L	BW	BL	P
<b>0306</b>	1.60 ± 0.20 (0.063 ± 0.008)	0.82 ± 0.10 (0.032 ± 0.006)	0.25 ± 0.10 (0.010 ± 0.004)	0.20 ± 0.10 (0.008 ± 0.004)	0.40 ± 0.05 (0.015 ± 0.002)
<b>0508</b>	2.03 ± 0.20 (0.080 ± 0.008)	1.27 ± 0.20 (0.050 ± 0.008)	0.30 ± 0.10 (0.012 ± 0.004)	0.25 ± 0.15 (0.010 ± 0.006)	0.50 ± 0.05 (0.020 ± 0.002)
<b>0612</b>	3.20 ± 0.20 (0.126 ± 0.008)	1.60 ± 0.20 (0.063 ± 0.008)	0.50 ± 0.10 (0.020 ± 0.004)	0.25 ± 0.15 (0.010 ± 0.006)	0.80 ± 0.10 (0.031 ± 0.004)

### PAD LAYOUT DIMENSIONS

SIZE	A	B	C	D	E
<b>0306</b>	0.38 (0.015)	0.89 (0.035)	1.27 (0.050)	0.20 (0.008)	0.40 (0.015)
<b>0508</b>	0.64 (0.025)	1.27 (0.050)	1.91 (0.075)	0.28 (0.011)	0.50 (0.020)
<b>0612</b>	0.89 (0.035)	1.65 (0.065)	2.54 (0.100)	0.45 (0.018)	0.80 (0.031)

# IDC Low Inductance Capacitors (SnPb)

## 0306/0612/0508 IDC with Sn/Pb Termination

### GENERAL DESCRIPTION

Inter-Digitated Capacitors (IDCs) are used for both semiconductor package and board level decoupling. The equivalent series inductance (ESL) of a single capacitor or an array of capacitors in parallel determines the response time of a Power Delivery Network (PDN). The lower the ESL of a PDN, the faster the response time. A designer can use many standard MLCCs in parallel to reduce ESL or a low ESL Inter-Digitated Capacitor (IDC) device. These IDC devices are available in versions with a maximum height of 0.95mm or 0.55mm.

IDCs are typically used on packages of semiconductor products with power levels of 15 watts or greater. Inter-Digitated Capacitors are used on CPU, GPU, ASIC, and ASSP devices produced on 0.13μ, 90nm, 65nm, and 45nm processes. IDC devices are used on both ceramic and organic package substrates. These low ESL surface mount capacitors can be placed on the bottom side or the top side of a package substrate. The low profile 0.55mm maximum height IDCs can easily be used on the bottom side of BGA packages or on the die side of packages under a heat spreader.

IDCs are used for board level decoupling of systems with speeds of 300MHz or greater. Low ESL IDCs free up valuable board space by reducing the number of capacitors required versus standard MLCCs. There are additional benefits to reducing the number of capacitors beyond saving board space including higher reliability from a reduction in the number of components and lower placement costs based on the need for fewer capacitors.

The Inter-Digitated Capacitor (IDC) technology was developed by AVX. This is the second family of Low Inductance MLCC products created by AVX. IDCs are a cost effective alternative to AVX's first generation low ESL family for high-reliability applications known as LICA (Low Inductance Chip Array).

AVX IDC products are available with a lead termination for high reliability military and aerospace applications that must avoid tin whisker reliability issues.

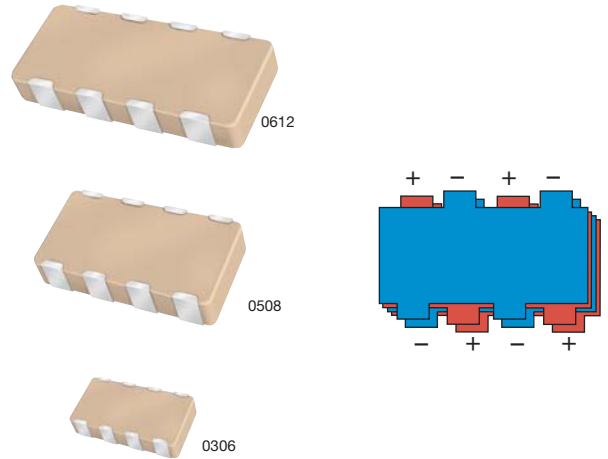

### TYPICAL IMPEDANCE

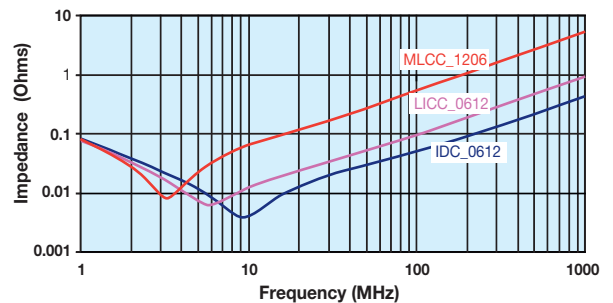

**Not RoHS Compliant**

### HOW TO ORDER

<b>L</b>	<b>3</b>	<b>L</b>	<b>1</b>	<b>6</b>	<b>D</b>	<b>225</b>	<b>M</b>	<b>A</b>	<b>B</b>	<b>3</b>	<b>A</b>
<b>Style</b>	<b>IDC Case Size</b>	<b>Low Inductance</b>	<b>Number of Terminals</b>	<b>Voltage</b>	<b>Dielectric</b>	<b>Capacitance Code (In pF)</b>	<b>Capacitance Tolerance</b>	<b>Failure Rate</b>	<b>Termination</b>	<b>Packaging Available</b>	<b>Thickness</b>
	2 = 0508 3 = 0612 4 = 0306		1 = 8 Terminals	4 = 4V 6 = 6.3V Z = 10V Y = 16V 3 = 25V	C = X7R D = X5R Z = X7S	2 Sig. Digits + Number of Zeros	M = ±20%	A = N/A	B = 5% min. Lead	1=7" Reel 3=13" Reel	<u>Max. Thickness</u> mm (in.) A=Standard S=0.55 (0.022)

NOTE: Contact factory for availability of Termination and Tolerance Options for Specific Part Numbers.

### PERFORMANCE CHARACTERISTICS

<b>Capacitance Tolerance</b>	±20% Preferred
<b>Operation Temperature Range</b>	X7R = -55°C to +125°C X5R = -55°C to +85°C X7S = -55°C to +125°C
<b>Temperature Coefficient</b>	±15% (0VDC), ±22% (X7S)
<b>Voltage Ratings</b>	4, 6.3, 10, 16, 25 VDC
<b>Dissipation Factor</b>	≤ 6.3V = 6.5% max; 10V = 5.0% max; ≥ 16V = 3.5% max
<b>Insulation Resistance (@+25°C, RVDC)</b>	100,000MΩ min, or 1,000MΩ per μF min., whichever is less

<b>Dielectric Strength</b>	No problems observed after 2.5 x RVDC for 5 seconds at 50mA max current
<b>CTE (ppm/C)</b>	12.0
<b>Thermal Conductivity</b>	4-5W/M K
<b>Terminations Available</b>	Plated Nickel and Solder

# IDC Low Inductance Capacitors (SnPb)

## 0306/0612/0508 IDC with Sn/Pb Termination

SIZE	0306		Thin 0508			0508			Thin 0612				0612					THICK 0612										
Max. Thickness	0.55 (0.022)		0.55 (0.022)			0.95 (0.037)			0.55 (0.022)				0.95 (0.037)					1.22 (0.048)										
WVDC	4	6.3	4	6.3	10	16	25	4	6.3	10	16	25	4	6.3	10	16	25	4	6.3	10	16	25	4	6.3	10	16		
Cap (μF)	Grid content representing availability of capacitor values across different sizes and WVDC ratings																											

### PHYSICAL DIMENSIONS AND PAD LAYOUT

Consult factory for additional requirements

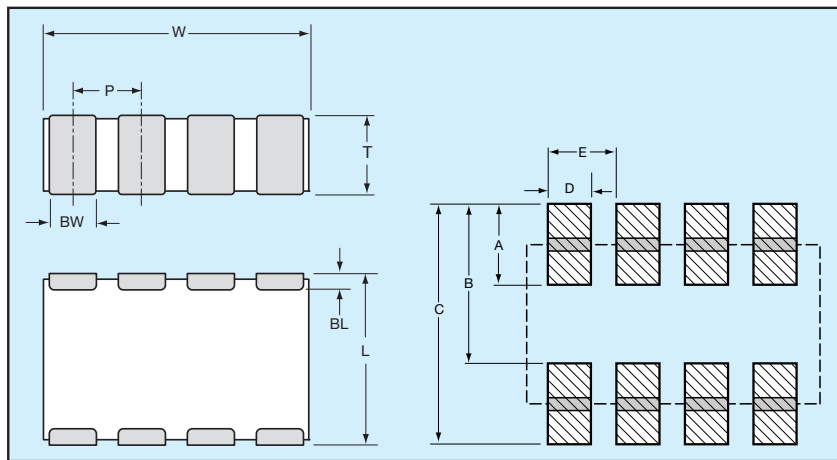

- = X7R
- = X5R
- = X7S

### PHYSICAL CHIP DIMENSIONS millimeters (inches)

SIZE	W	L	BW	BL	P
<b>0306</b>	1.60 ± 0.20 (0.063 ± 0.008)	0.82 ± 0.10 (0.032 ± 0.006)	0.25 ± 0.10 (0.010 ± 0.004)	0.20 ± 0.10 (0.008 ± 0.004)	0.40 ± 0.05 (0.015 ± 0.002)
<b>0508</b>	2.03 ± 0.20 (0.080 ± 0.008)	1.27 ± 0.20 (0.050 ± 0.008)	0.30 ± 0.10 (0.012 ± 0.004)	0.25 ± 0.15 (0.010 ± 0.006)	0.50 ± 0.05 (0.020 ± 0.002)
<b>0612</b>	3.20 ± 0.20 (0.126 ± 0.008)	1.60 ± 0.20 (0.063 ± 0.008)	0.50 ± 0.10 (0.020 ± 0.004)	0.25 ± 0.15 (0.010 ± 0.006)	0.80 ± 0.10 (0.031 ± 0.004)

### PAD LAYOUT DIMENSIONS

SIZE	A	B	C	D	E
<b>0306</b>	0.38 (0.015)	0.89 (0.035)	1.27 (0.050)	0.20 (0.008)	0.40 (0.015)
<b>0508</b>	0.64 (0.025)	1.27 (0.050)	1.91 (0.075)	0.28 (0.011)	0.50 (0.020)
<b>0612</b>	0.89 (0.035)	1.65 (0.065)	2.54 (0.101)	0.45 (0.018)	0.80 (0.031)

# LGA Low Inductance Capacitors



## 0204/0306/0805 Land Grid Arrays

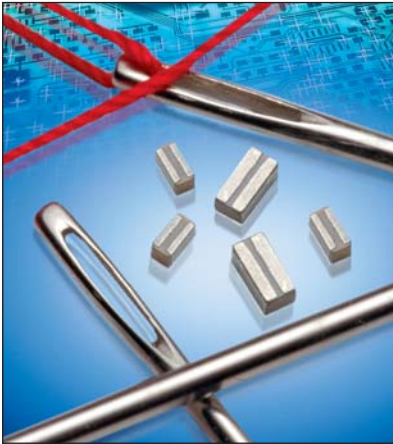

Land Grid Array (LGA) capacitors are the latest family of low inductance MLCCs from AVX. These new LGA products are the third low inductance family developed by AVX. The innovative LGA technology sets a new standard for low inductance MLCC performance. *Electronic Products* awarded its 2006 Product of the Year Award to the LGA Decoupling capacitor.

Our initial 2 terminal versions of LGA technology deliver the performance of an 8 terminal IDC low inductance MLCC with a number of advantages including:

- Simplified layout of 2 large solder pads compared to 8 small pads for IDCs
- Opportunity to reduce PCB or substrate contribution to system ESL by using multiple parallel vias in solder pads
- Advanced FCT manufacturing process used to create uniformly flat terminations on the capacitor that resist “tombstoning”
- Better solder joint reliability

### APPLICATIONS

#### Semiconductor Packages

- Microprocessors/CPU's
- Graphics Processors/GPU's
- Chipsets
- FPGA's
- ASIC's

#### Board Level Device Decoupling

- Frequencies of 300 MHz or more
- IC's drawing 15W or more
- Low voltages
- High speed buses



### 0306 2 TERMINAL LGA COMPARISON WITH 0306 8 TERMINAL IDC

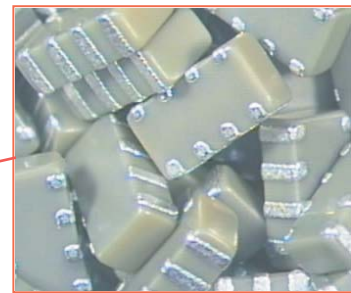
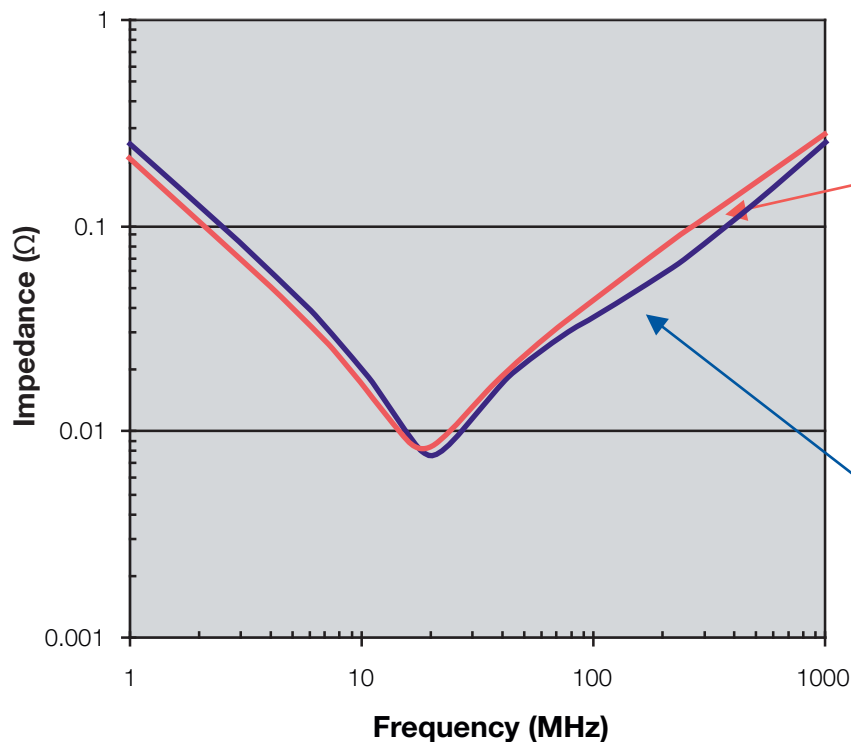

# LGA Low Inductance Capacitors



## 0204/0306/0805 Land Grid Arrays

SIZE	LG12 (0204)						LG22 (0306)						LGC2 (0805)										
Length mm (in.)	0.50 (0.020)						0.76 (0.030)						2.06 (0.081)										
Width mm (in.)	1.00 (0.039)						1.60 (0.063)						1.32 (0.052)										
Temp. Char.	X5R (D)		X7S (Z)		X6S (W)		X7R (C)			X5R (D)		X7S (Z)		X6S (W)		X7R (C)		X5R (D)		X7S (Z)		X6S (W)	
Working Voltage	6.3 (6)	4 (4)	6.3 (6)	4 (4)	6.3 (6)	4 (4)	10 (Z)	6.3 (6)	4 (4)	6.3 (6)	4 (4)	6.3 (6)	4 (4)	6.3 (6)	4 (4)	6.3 (6)	4 (4)	6.3 (6)	4 (4)	6.3 (6)	4 (4)	6.3 (6)	4 (4)
Cap (µF)	0.010 (103)																						

= X7R
  = X5R
  = X7S
  = X6S

### HOW TO ORDER

<b>LG</b>	<b>1</b>	<b>2</b>	<b>6</b>	<b>Z</b>	<b>104</b>	<b>M</b>	<b>A</b>	<b>T</b>	<b>2</b>	<b>S</b>	<b>1</b>
<b>Style</b>	<b>Case Size</b>	<b>Number of Terminals</b>	<b>Working Voltage</b>	<b>Temperature Characteristic</b>	<b>Coded Cap</b>	<b>Cap Tolerance</b>	<b>Termination Style</b>	<b>Termination</b>	<b>Packaging Tape &amp; Reel</b>	<b>Thickness</b>	<b>Number of Capacitors</b>
	1 = 0204 2 = 0306 C = 0805	2	4 = 4V 6 = 6.3V Z = 10V	C = X7R D = X5R Z = X7S W = X6S		M = 20%	A = "U" Land	100% Sn* <small>*Contact factory for other termination finishes</small>	2 = 7" Reel 4 = 13" Reel	S = 0.55mm max	

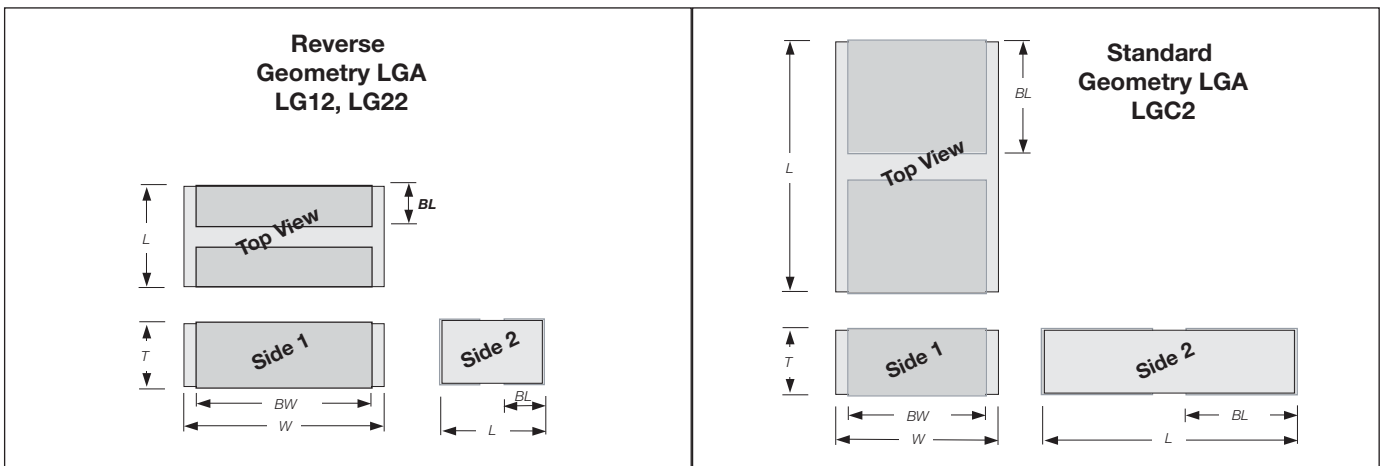

### PART DIMENSIONS

Series	L	W	T	BW	BL
LG12 (0204)	0.5 ± 0.05 (0.020 ± 0.002)	1.00 ± 0.10 (0.039 ± 0.004)	0.50 ± 0.05 (0.020 ± 0.002)	0.8 ± 0.10 (0.031 ± 0.004)	0.13 ± 0.08 (0.005 ± 0.003)
LG22 (0306)	0.76 ± 0.10 (0.030 ± 0.004)	1.60 ± 0.10 (0.063 ± 0.004)	0.50 ± 0.05 (0.020 ± 0.002)	1.50 ± 0.10 (0.059 ± 0.004)	0.28 ± 0.08 (0.011 ± 0.003)
LGC2 (0805)	2.06 ± 0.10 (0.081 ± 0.004)	1.32 ± 0.10 (0.052 ± 0.004)	0.50 ± 0.05 (0.020 ± 0.002)	1.14 ± 0.10 (0.045 ± 0.004)	0.90 ± 0.08 (0.035 ± 0.003)



### RECOMMENDED SOLDER PAD DIMENSIONS

mm (inches)

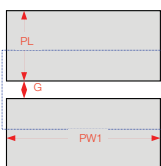

Series	PL	PW1	G
LG12 (0204)	0.50 (0.020)	1.00 (0.039)	0.20 (0.008)
LG22 (0306)	0.65 (0.026)	1.50 (0.059)	0.20 (0.008)
LGC2 (0805)	1.25 (0.049)	1.40 (0.055)	0.20 (0.008)



# LGA Low Inductance Capacitors



## 0204/0306/0805 Land Grid Arrays – Tin/Lead Termination “B”

SIZE	LG12 (0204)						LG22 (0306)						LGC2 (0805)										
Length mm (in.)	0.50 (0.020)						0.76 (0.030)						2.06 (0.081)										
Width mm (in.)	1.00 (0.039)						1.60 (0.063)						1.32 (0.052)										
Temp. Char.	X5R (D)		X7S (Z)		X6S (W)		X7R (C)			X5R (D)		X7S (Z)		X6S (W)		X7R (C)		X5R (D)		X7S (Z)		X6S (W)	
Working Voltage	6.3 (6)	4 (4)	6.3 (6)	4 (4)	6.3 (6)	4 (4)	10 (Z)	6.3 (6)	4 (4)	6.3 (6)	4 (4)	6.3 (6)	4 (4)	6.3 (6)	4 (4)	6.3 (6)	4 (4)	6.3 (6)	4 (4)	6.3 (6)	4 (4)	6.3 (6)	4 (4)
Cap (µF)	0.010 (103)																						

= X7R   
  = X5R   
  = X7S   
  = X6S

### HOW TO ORDER

<b>PG</b>	<b>1</b>	<b>2</b>	<b>6</b>	<b>Z</b>	<b>104</b>	<b>M</b>	<b>A</b>	<b>B</b>	<b>2</b>	<b>S</b>	<b>1</b>
Style	Case Size	Number of Terminals	Working Voltage	Temperature Characteristic	Coded Cap	Cap Tolerance	Termination Style	Termination	Packaging Tape & Reel	Thickness	Number of Capacitors
	1 = 0204 2 = 0306 C = 0805	2	4 = 4V 6 = 6.3V Z = 10V	C = X7R D = X5R Z = X7S W = X6S		M = 20%	A = "U" Land	5% Min Lead	2 = 7" Reel 4 = 13" Reel	S = 0.55mm max	

Not RoHS Compliant

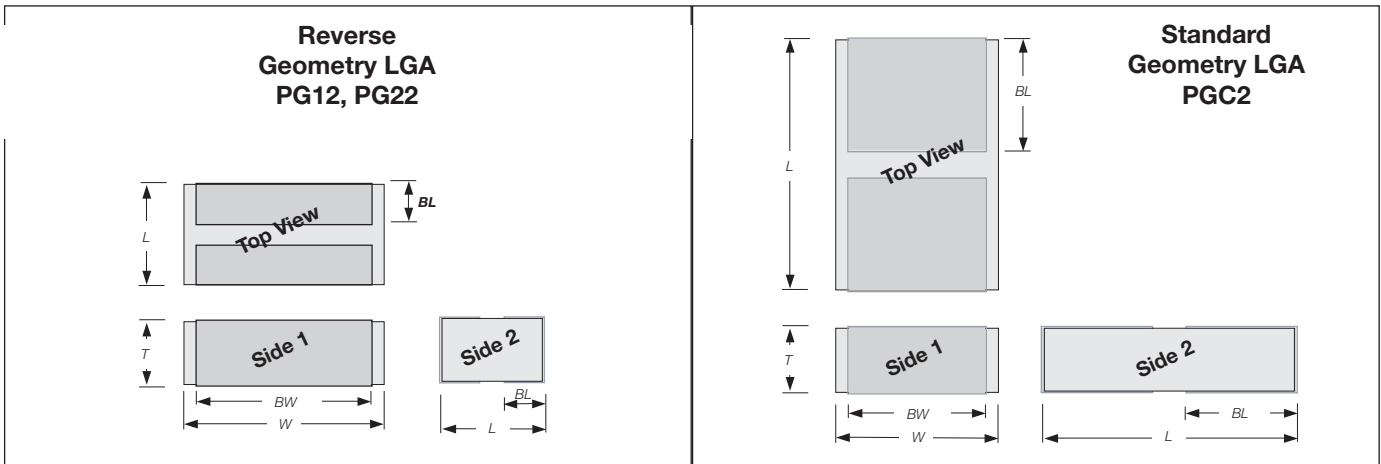

### PART DIMENSIONS

Series	mm (inches)				
	L	W	T	BW	BL
PG12 (0204)	0.5 ± 0.05 (0.020 ± 0.002)	1.00 ± 0.10 (0.039 ± 0.004)	0.50 ± 0.05 (0.020 ± 0.002)	0.8 ± 0.10 (0.031 ± 0.004)	0.13 ± 0.08 (0.005 ± 0.003)
PG22 (0306)	0.76 ± 0.10 (0.030 ± 0.004)	1.60 ± 0.10 (0.063 ± 0.004)	0.50 ± 0.05 (0.020 ± 0.002)	1.50 ± 0.10 (0.059 ± 0.004)	0.28 ± 0.08 (0.011 ± 0.003)
PGC2 (0805)	2.06 ± 0.10 (0.081 ± 0.004)	1.32 ± 0.10 (0.052 ± 0.004)	0.50 ± 0.05 (0.020 ± 0.002)	1.14 ± 0.10 (0.045 ± 0.004)	0.90 ± 0.08 (0.035 ± 0.003)

### RECOMMENDED SOLDER PAD DIMENSIONS

mm (inches)



Series	PL	PW1	G
PG12 (0204)	0.50 (0.020)	1.00 (0.039)	0.20 (0.008)
PG22 (0306)	0.65 (0.026)	1.50 (0.059)	0.20 (0.008)
PGC2 (0805)	1.25 (0.049)	1.40 (0.055)	0.20 (0.008)



# Low Inductance Capacitors



## LICA® (Low Inductance Decoupling Capacitor Arrays)



LICA® arrays utilize up to four separate capacitor sections in one ceramic body (see Configurations and Capacitance Options). These designs exhibit a number of technical advancements:

Low Inductance features–

- Low resistance platinum electrodes in a low aspect ratio pattern
- Double electrode pickup and perpendicular current paths
- C4 “flip-chip” technology for minimal interconnect inductance

### HOW TO ORDER

LICA	3	T	102	M	3	F	C	4	A	A
<b>Style &amp; Size</b>	5V = 9 10V = Z 25V = 3	D = X5R T = T55T S = High K T55T	<b>Cap/Section (EIA Code)</b> 102 = 1000 pF 103 = 10 nF 104 = 100 nF	<b>Capacitance Tolerance</b> M = ±20% P = GMV	<b>Height Code</b> 6 = 0.500mm 3 = 0.650mm 1 = 0.875mm 5 = 1.100mm 7 = 1.600mm	<b>Termination</b> F = C4 Solder Balls- 97Pb/3Sn H = C4 Solder Balls Low ESR G = Lead Free SAC R = Cr-Cu-Au N = Cr-Ni-Au V = Eutectic Lead-Tin Bump- 37%Pb/63%Sn X = None	<b>Reel Packaging</b> M = 7" Reel R = 13" Reel 6 = 2"x2" Waffle Pack 8 = 2"x2" Black Waffle Pack 7 = 2"x2" Waffle Pack w/ termination facing up A = 2"x2" Black Waffle Pack w/ termination facing up C = 4"x4" Waffle Pack w/ clear lid	<b># of Caps/Part</b> 1 = one 2 = two 4 = four	<b>Inspection Code</b> A = Standard B = COTS+ X = MIL-PRF-123	<b>Code Face</b> A = Bar B = No Bar C = Dot, S55S Dielectrics D = Triangle

NOTE: Contact factory for availability of Termination and Tolerance Options for Specific Part Numbers.

TABLE 1

Typical Parameters	T55T/S55S	Units
Capacitance, 25°C	Co	Nanofarads
Capacitance, 55°C	1.45 x Co	Nanofarads
Capacitance, 85°C	0.7 x Co	Nanofarads
Dissipation Factor 25°	15	Percent
ESR (Nominal)	20	Milliohms
DC Resistance	0.2	Ohms
IR (Minimum @25°) (Design Dependent)	300	Megaohms
Dielectric Breakdown, Min	500	Volts
Thermal Coefficient of Expansion	8.5	ppm/°C 25-100°
Inductance: (Design Dependent) (Nominal)	30	Pico-Henries
Frequency of Operation	DC to 5 Gigahertz	
Ambient Temp Range	-55° to 125°C	



### SOLDER BALL AND PAD DIMENSIONS

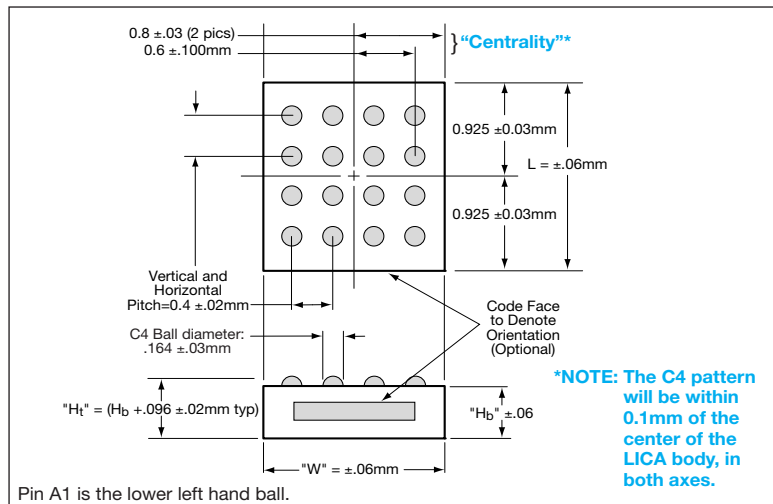

Code (Body Height)	Width (W)	Length (L)	Height Body (H <sub>b</sub> )
1	1.600mm	1.850mm	0.875mm
3	1.600mm	1.850mm	0.650mm
5	1.600mm	1.850mm	1.100mm
6	1.600mm	1.850mm	0.500mm
7	1.600mm	1.850mm	1.600mm

### TERMINATION OPTIONS

SOLDER BALLS  
TERMINATION OPTION F, H, G OR V

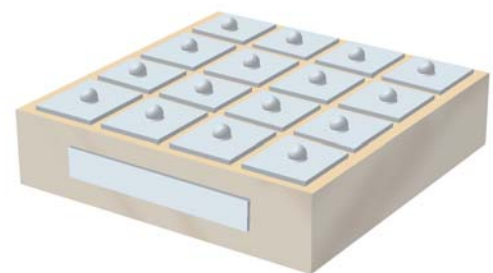

TERMINATION OPTION R OR N

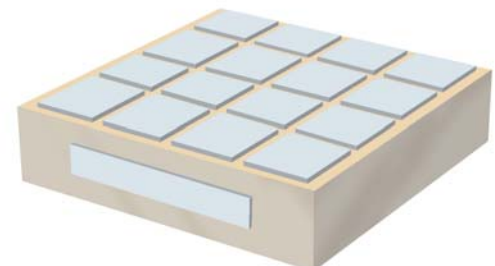



# Low Inductance Capacitors



## LICA® (Low Inductance Decoupling Capacitor Arrays)

### TEMPERATURE VS CAPACITANCE CHANGE

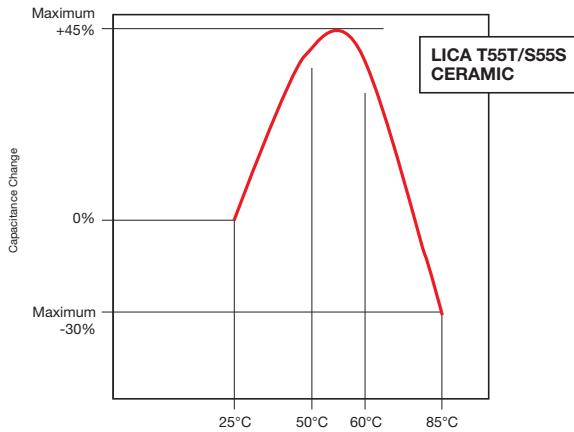

### TYPICAL S21 FOR LICA AT SINGLE VIA

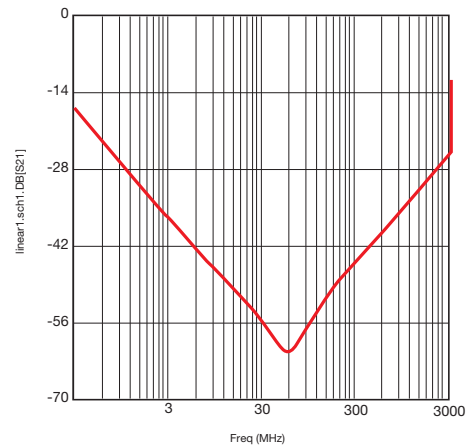

### LICA COMMON PART NUMBER LIST

Part Number	Voltage	Thickness (mm)	Capacitors per Package
LICA3T193M3FC4AA	25	0.650	4
LICA3T153P3FC4AA	25	0.650	4
LICA3T134M1FC1AA	25	0.875	1
LICA3T104P1FC1AA	25	0.875	1
LICA3T333M1FC4AA	25	0.875	4
LICA3T263P3FC4AA	25	0.650	4
LICA3T244M5FC1AA	25	1.100	1
LICA3T194P5FC1AA	25	1.100	1
LICA3T394M7FC1AB	25	1.600	1
LICA3T314P7FC1AB	25	1.600	1
<b>Extended Range</b>			
LICAZT623M3FC4AB	10	0.650	4
LICA3T104M3FC1A	25	0.650	1
LICA3T803P3FC1A	25	0.650	1
LICA3T423M3FC2A	25	0.650	2
LICA3T333P3FC2A	25	0.650	2
LICA3S253M3FC4A	25	0.650	4
LICAZD753M3FC4AD	10	0.650	4
LICAZD504M3FC1AB	10	0.650	1
LICAZD604M7FC1AB	10	1.600	1
LICA3D193M3FC4AB	25	0.650	4

### CONFIGURATION

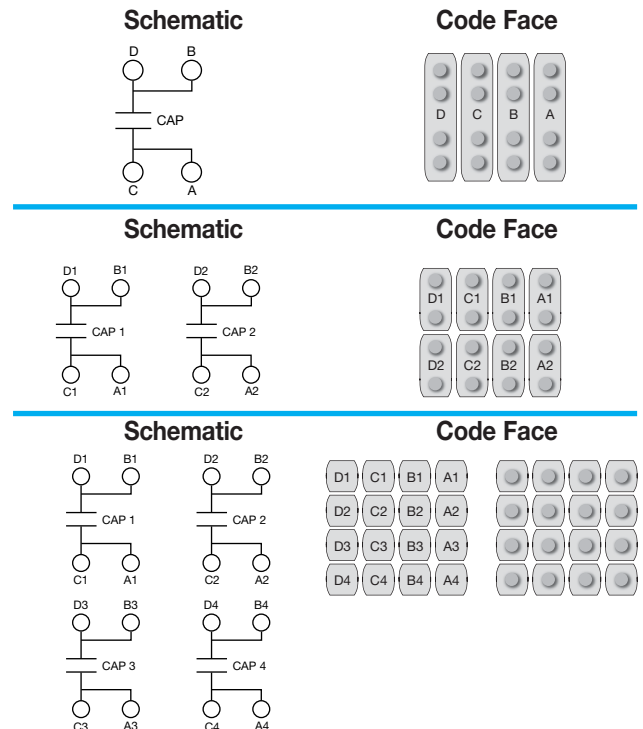

### WAFFLE PACK OPTIONS FOR LICA®

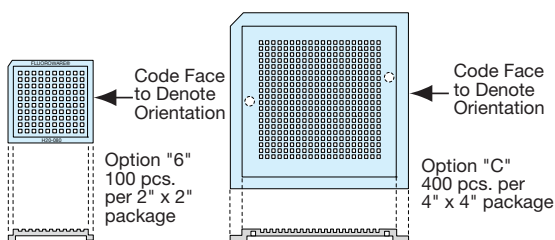

Note: Standard configuration is Termination side down

### LICA® PACKAGING SCHEME "M" AND "R"

8mm conductive plastic tape on reel:  
 "M"=7" reel max. qty. 3,000, "R"=13" reel max. qty. 8,000

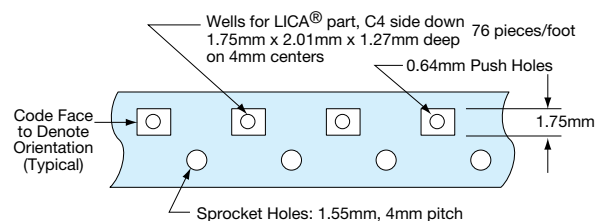

# High Voltage MLC Chips



For 600V to 5000V Applications

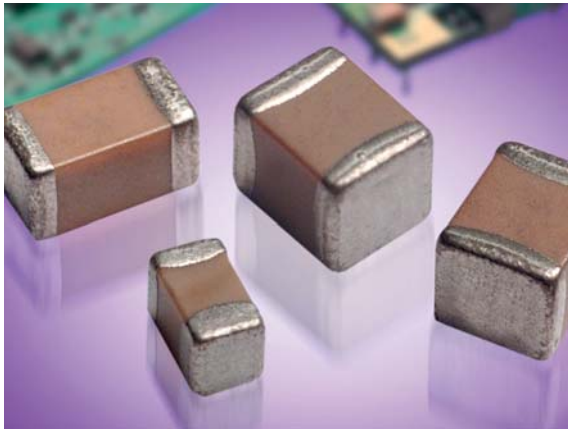

**NEW 630V RANGE**

High value, low leakage and small size are difficult parameters to obtain in capacitors for high voltage systems. AVX special high voltage MLC chip capacitors meet these performance characteristics and are designed for applications such as snubbers in high frequency power converters, resonators in SMPS, and high voltage coupling/dc blocking. These high voltage chip designs exhibit low ESRs at high frequencies.

Larger physical sizes than normally encountered chips are used to make high voltage MLC chip products. Special precautions must be taken in applying these chips in surface mount assemblies. The temperature gradient during heating or cooling cycles should not exceed 4°C per second. The preheat temperature must be within 50°C of the peak temperature reached by the ceramic bodies through the soldering process. Chip sizes 1210 and larger should be reflow soldered only. Capacitors may require protective surface coating to prevent external arcing.

For 1825, 2225 and 3640 sizes, AVX offers leaded version in either thru-hole or SMT configurations (for details see section on high voltage leaded MLC chips).

## HOW TO ORDER

1808	A	A	271	K	A	1	1	A
AVX Style	Voltage	Temperature Coefficient	Capacitance Code (2 significant digits + no. of zeros) Examples:	Capacitance Tolerance COG: J = ±5% K = ±10% M = ±20% X7R: K = ±10% M = ±20% Z = +80%, -20%	Test Level A = Standard	Termination* 1 = Pd/Ag T = Plated Ni and Sn (RoHS Compliant)	Packaging 1 = 7" Reel 3 = 13" Reel 9 = Bulk	Special Code A = Standard
0805	600V/630V = C 1000V = A 1500V = S 2000V = G	COG = A X7R = C	10 pF = 100 100 pF = 101 1,000 pF = 102 22,000 pF = 223 220,000 pF = 224 1 μF = 105					
1206	2500V = W							
1210	3000V = H							
1808	4000V = J							
1812	5000V = K							
1825								
2220								
2225								
3640								

**\*\*\***

**\*Note:** Terminations with 5% minimum lead (Pb) is available, see pages 83 and 84 for LD style. Leaded terminations are available, see pages 85 and 86.

Notes: Capacitors with X7R dielectrics are not intended for applications across AC supply mains or AC line filtering with polarity reversal. Contact plant for recommendations. Contact factory for availability of Termination and Tolerance options for Specific Part Numbers.

\*\*\* AVX offers nonstandard chip sizes. Contact factory for details.

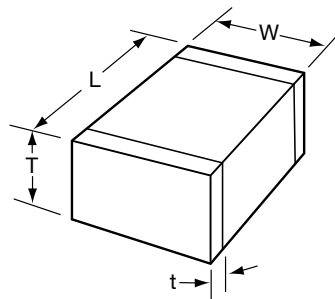

## DIMENSIONS

millimeters (inches)

SIZE	0805	1206	1210*	1808*	1812*	1825*	2220*	2225*	3640*
(L) Length	2.01 ± 0.20 (0.079 ± 0.008)	3.20 ± 0.20 (0.126 ± 0.008)	3.20 ± 0.20 (0.126 ± 0.008)	4.57 ± 0.25 (0.180 ± 0.010)	4.50 ± 0.30 (0.177 ± 0.012)	4.50 ± 0.30 (0.177 ± 0.012)	5.70 ± 0.40 (0.224 ± 0.016)	5.72 ± 0.25 (0.225 ± 0.010)	9.14 ± 0.25 (0.360 ± 0.010)
(W) Width	1.25 ± 0.20 (0.049 ± 0.008)	1.60 ± 0.20 (0.063 ± 0.008)	2.50 ± 0.20 (0.098 ± 0.008)	2.03 ± 0.25 (0.080 ± 0.010)	3.20 ± 0.20 (0.126 ± 0.008)	6.40 ± 0.30 (0.252 ± 0.012)	5.00 ± 0.40 (0.197 ± 0.016)	6.35 ± 0.25 (0.250 ± 0.010)	10.2 ± 0.25 (0.400 ± 0.010)
(T) Thickness Max.	1.30 (0.051)	1.52 (0.060)	1.70 (0.067)	2.03 (0.080)	2.54 (0.100)	2.54 (0.100)	3.30 (0.130)	2.54 (0.100)	2.54 (0.100)
(t) terminal min. max.	0.50 ± 0.25 (0.020 ± 0.010)	0.25 (0.010) 0.75 (0.030)	0.25 (0.010) 0.75 (0.030)	0.25 (0.010) 1.02 (0.040)	0.25 (0.010) 1.02 (0.040)	0.25 (0.010) 1.02 (0.040)	0.25 (0.010) 1.02 (0.040)	0.25 (0.010) 1.02 (0.040)	0.76 (0.030) 1.52 (0.060)

\*Reflow Soldering Only



# High Voltage MLC Chips



For 600V to 5000V Applications

## C0G Dielectric

### Performance Characteristics

<b>Capacitance Range</b>	10 pF to 0.047 $\mu$ F (25°C, 1.0 $\pm$ 0.2 Vrms at 1kHz, for $\leq$ 1000 pF use 1 MHz)
<b>Capacitance Tolerances</b>	$\pm$ 5%, $\pm$ 10%, $\pm$ 20%
<b>Dissipation Factor</b>	0.1% max. (+25°C, 1.0 $\pm$ 0.2 Vrms, 1kHz, for $\leq$ 1000 pF use 1 MHz)
<b>Operating Temperature Range</b>	-55°C to +125°C
<b>Temperature Characteristic</b>	0 $\pm$ 30 ppm/°C (0 VDC)
<b>Voltage Ratings</b>	600, 630, 1000, 1500, 2000, 2500, 3000, 4000 & 5000 VDC (+125°C)
<b>Insulation Resistance</b> (+25°C, at 500 VDC)	100K M $\Omega$ min. or 1000 M $\Omega$ - $\mu$ F min., whichever is less
<b>Insulation Resistance</b> (+125°C, at 500 VDC)	10K M $\Omega$ min. or 100 M $\Omega$ - $\mu$ F min., whichever is less
<b>Dielectric Strength</b>	Minimum 120% rated voltage for 5 seconds at 50 mA max. current

## HIGH VOLTAGE C0G CAPACITANCE VALUES

VOLTAGE	0805	1206	1210	1808	1812	1825	2220	2225	3640	
600/630	min.	10pF	10 pF	100 pF	100 pF	100 pF	1000 pF	1000 pF	1000 pF	1000 pF
	max.	330pF	1200 pF	2700 pF	3300 pF	5600 pF	0.012 $\mu$ F	0.012 $\mu$ F	0.018 $\mu$ F	0.047 $\mu$ F
1000	min.	10pF	10 pF	10 pF	100 pF	100 pF	100 pF	1000 pF	1000 pF	1000 pF
	max.	180pF	560 pF	1500 pF	2200 pF	3300 pF	8200 pF	0.010 $\mu$ F	0.010 $\mu$ F	0.022 $\mu$ F
1500	min.	—	10 pF	10 pF	10 pF	10 pF	100 pF	100 pF	100 pF	100 pF
	max.	—	270 pF	680 pF	820 pF	1800 pF	4700 pF	4700 pF	5600 pF	0.010 $\mu$ F
2000	min.	—	10 pF	10 pF	10 pF	10 pF	100 pF	100 pF	100 pF	100 pF
	max.	—	120 pF	270 pF	330 pF	1000 pF	1800 pF	2200 pF	2700 pF	6800 pF
2500	min.	—	—	—	10 pF	10 pF	10 pF	100 pF	100 pF	100 pF
	max.	—	—	—	180 pF	470 pF	1200 pF	1500 pF	1800 pF	3900 pF
3000	min.	—	—	—	10 pF	10 pF	10 pF	10 pF	10 pF	100 pF
	max.	—	—	—	120 pF	330 pF	820 pF	1000 pF	1200 pF	2700 pF
4000	min.	—	—	—	10 pF	10 pF	10 pF	10 pF	10 pF	100 pF
	max.	—	—	—	47 pF	150 pF	330 pF	470 pF	560 pF	1200 pF
5000	min.	—	—	—	—	—	—	10 pF	10 pF	10 pF
	max.	—	—	—	—	—	—	220 pF	270 pF	820 pF

## X7R Dielectric

### Performance Characteristics

<b>Capacitance Range</b>	10 pF to 0.56 $\mu$ F (25°C, 1.0 $\pm$ 0.2 Vrms at 1kHz)
<b>Capacitance Tolerances</b>	$\pm$ 10%; $\pm$ 20%; +80%, -20%
<b>Dissipation Factor</b>	2.5% max. (+25°C, 1.0 $\pm$ 0.2 Vrms, 1kHz)
<b>Operating Temperature Range</b>	-55°C to +125°C
<b>Temperature Characteristic</b>	$\pm$ 15% (0 VDC)
<b>Voltage Ratings</b>	600, 630, 1000, 1500, 2000, 2500, 3000, 4000 & 5000 VDC (+125°C)
<b>Insulation Resistance</b> (+25°C, at 500 VDC)	100K M $\Omega$ min. or 1000 M $\Omega$ - $\mu$ F min., whichever is less
<b>Insulation Resistance</b> (+125°C, at 500 VDC)	10K M $\Omega$ min. or 100 M $\Omega$ - $\mu$ F min., whichever is less
<b>Dielectric Strength</b>	Minimum 120% rated voltage for 5 seconds at 50 mA max. current

## HIGH VOLTAGE X7R MAXIMUM CAPACITANCE VALUES

VOLTAGE	0805	1206	1210	1808	1812	1825	2220	2225	3640	
600/630	min.	100pF	1000 pF	1000 pF	1000 pF	1000 pF	0.010 $\mu$ F	0.010 $\mu$ F	0.010 $\mu$ F	0.010 $\mu$ F
	max.	6800pF	0.022 $\mu$ F	0.056 $\mu$ F	0.068 $\mu$ F	0.120 $\mu$ F	0.270 $\mu$ F	0.270 $\mu$ F	0.330 $\mu$ F	0.560 $\mu$ F
1000	min.	100pF	100 pF	1000 pF	1000 pF	1000 pF	1000 pF	1000 pF	1000 pF	1000 pF
	max.	1500pF	6800 pF	0.015 $\mu$ F	0.018 $\mu$ F	0.039 $\mu$ F	0.100 $\mu$ F	0.120 $\mu$ F	0.150 $\mu$ F	0.220 $\mu$ F
1500	min.	—	100 pF	100 pF	100 pF	100 pF	1000 pF	1000 pF	1000 pF	1000 pF
	max.	—	2700 pF	5600 pF	6800 pF	0.015 $\mu$ F	0.056 $\mu$ F	0.056 $\mu$ F	0.068 $\mu$ F	0.100 $\mu$ F
2000	min.	—	10 pF	100 pF	100 pF	100 pF	100 pF	1000 pF	1000 pF	1000 pF
	max.	—	1500 pF	3300 pF	3300 pF	8200 pF	0.022 $\mu$ F	0.027 $\mu$ F	0.033 $\mu$ F	0.027 $\mu$ F
2500	min.	—	—	—	10 pF	10 pF	100 pF	100 pF	100 pF	1000 pF
	max.	—	—	—	2200 pF	5600 pF	0.015 $\mu$ F	0.018 $\mu$ F	0.022 $\mu$ F	0.022 $\mu$ F
3000	min.	—	—	—	10 pF	10 pF	100 pF	100 pF	100 pF	1000 pF
	max.	—	—	—	1800 pF	3900 pF	0.010 $\mu$ F	0.012 $\mu$ F	0.015 $\mu$ F	0.018 $\mu$ F
4000	min.	—	—	—	—	—	—	—	—	100 pF
	max.	—	—	—	—	—	—	—	—	6800 pF
5000	min.	—	—	—	—	—	—	—	—	100 pF
	max.	—	—	—	—	—	—	—	—	3300 pF



# High Voltage MLC Chips Tin/Lead Termination “B”

For 600V to 5000V Applications

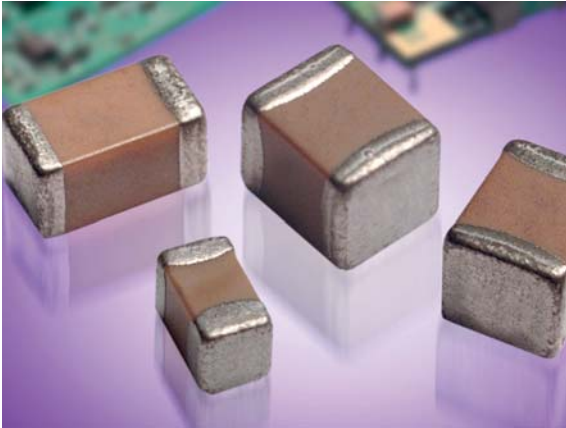

**NEW 630V RANGE**

AVX Corporation will support those customers for commercial and military Multilayer Ceramic Capacitors with a termination consisting of 5% minimum lead. This termination is indicated by the use of a “B” in the 12th position of the AVX Catalog Part Number. This fulfills AVX’s commitment to providing a full range of products to our customers. AVX has provided in the following pages, a full range of values that we are offering in this “B” termination.

Larger physical sizes than normally encountered chips are used to make high voltage MLC chip product. Special precautions must be taken in applying these chips in surface mount assemblies. The temperature gradient during heating or cooling cycles should not exceed 4°C per second. The preheat temperature must be within 50°C of the peak temperature reached by the ceramic bodies through the soldering process. Chip sizes 1210 and larger should be reflow soldered only. Capacitors may require protective surface coating to prevent external arcing.

For 1825, 2225 and 3640 sizes, AVX offers leaded version in either thru-hole or SMT configurations (for details see section on high voltage leaded MLC chips).

**Not RoHS Compliant**

## HOW TO ORDER

<b>LD08</b>	<b>A</b>	<b>A</b>	<b>271</b>	<b>K</b>	<b>A</b>	<b>B</b>	<b>1</b>	<b>A</b>
<b>AVX Style</b>	<b>Voltage</b>	<b>Temperature Coefficient</b>	<b>Capacitance Code</b> (2 significant digits + no. of zeros) Examples: 10 pF = 100 100 pF = 101 1,000 pF = 102 22,000 pF = 223 220,000 pF = 224 1 μF = 105	<b>Capacitance Tolerance</b> COG: J = ±5% K = ±10% M = ±20% X7R: K = ±10% M = ±20% Z = +80%, -20%	<b>Test Level</b> A = Standard	<b>Termination</b> B = 5% Min Pb	<b>Packaging</b> 1 = 7" Reel 3 = 13" Reel 9 = Bulk	<b>Special Code</b> A = Standard
LD05 - 0805	600V/630V = C 1000V = A	COG = A X7R = C						
LD06 - 1206	1500V = S							
LD10 - 1210	2000V = G							
LD08 - 1808	2500V = W							
LD12 - 1812	3000V = H							
LD13 - 1825	4000V = J							
LD20 - 2220	5000V = K							
LD14 - 2225								
LD40 - 3640								

Notes: Capacitors with X7R dielectrics are not intended for applications across AC supply mains or AC line filtering with polarity reversal. Contact plant for recommendations. Contact factory for availability of Termination and Tolerance options for Specific Part Numbers.

\*\*\* AVX offers nonstandard chip sizes. Contact factory for details.

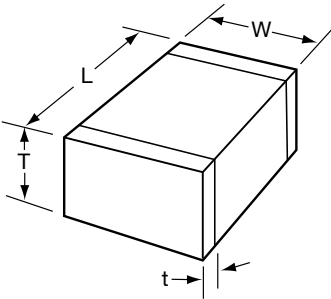

## DIMENSIONS

SIZE	LD05 (0805)	LD06 (1206)	LD10* (1210)	LD08* (1808)	LD12* (1812)	LD13* (1825)	LD20* (2220)	LD14* (2225)	LD40* (3640)
(L) Length	2.01 ± 0.20 (0.079 ± 0.008)	3.20 ± 0.20 (0.126 ± 0.008)	3.20 ± 0.20 (0.126 ± 0.008)	4.57 ± 0.25 (0.180 ± 0.010)	4.50 ± 0.30 (0.177 ± 0.012)	4.50 ± 0.30 (0.177 ± 0.012)	5.70 ± 0.40 (0.224 ± 0.016)	5.72 ± 0.25 (0.225 ± 0.010)	9.14 ± 0.25 (0.360 ± 0.010)
(W) Width	1.25 ± 0.20 (0.049 ± 0.008)	1.60 ± 0.20 (0.063 ± 0.008)	2.50 ± 0.20 (0.098 ± 0.008)	2.03 ± 0.25 (0.080 ± 0.010)	3.20 ± 0.20 (0.126 ± 0.008)	6.40 ± 0.30 (0.252 ± 0.012)	5.00 ± 0.40 (0.197 ± 0.016)	6.35 ± 0.25 (0.250 ± 0.010)	10.2 ± 0.25 (0.400 ± 0.010)
(T) Thickness Max.	1.30 (0.051)	1.52 (0.060)	1.70 (0.067)	2.03 (0.080)	2.54 (0.100)	2.54 (0.100)	3.30 (0.130)	2.54 (0.100)	2.54 (0.100)
(t) terminal min. max.	0.50 ± 0.25 (0.020 ± 0.010)	0.25 (0.010) 0.75 (0.030)	0.25 (0.010) 0.75 (0.030)	0.25 (0.010) 1.02 (0.040)	0.25 (0.010) 1.02 (0.040)	0.25 (0.010) 1.02 (0.040)	0.25 (0.010) 1.02 (0.040)	0.25 (0.010) 1.02 (0.040)	0.76 (0.030) 1.52 (0.060)

\* Reflow soldering only.



# High Voltage MLC Chips Tin/Lead Termination “B”



For 600V to 5000V Applications

## C0G Dielectric

### Performance Characteristics

<b>Capacitance Range</b>	10 pF to 0.047 $\mu$ F (25°C, 1.0 $\pm$ 0.2 Vrms at 1kHz, for $\leq$ 1000 pF use 1 MHz)
<b>Capacitance Tolerances</b>	$\pm$ 5%, $\pm$ 10%, $\pm$ 20%
<b>Dissipation Factor</b>	0.1% max. (+25°C, 1.0 $\pm$ 0.2 Vrms, 1kHz, for $\leq$ 1000 pF use 1 MHz)
<b>Operating Temperature Range</b>	-55°C to +125°C
<b>Temperature Characteristic</b>	0 $\pm$ 30 ppm/°C (0 VDC)
<b>Voltage Ratings</b>	600, 630, 1000, 1500, 2000, 2500, 3000, 4000 & 5000 VDC (+125°C)
<b>Insulation Resistance</b> (+25°C, at 500 VDC)	100K M $\Omega$ min. or 1000 M $\Omega$ - $\mu$ F min., whichever is less
<b>Insulation Resistance</b> (+125°C, at 500 VDC)	10K M $\Omega$ min. or 100 M $\Omega$ - $\mu$ F min., whichever is less
<b>Dielectric Strength</b>	Minimum 120% rated voltage for 5 seconds at 50 mA max. current

## HIGH VOLTAGE C0G CAPACITANCE VALUES

VOLTAGE	LD05 (0805)	LD06 (1206)	LD10 (1210)	LD08 (1808)	LD12 (1812)	LD13 (1825)	LD20 (2220)	LD14 (2225)	LD40 (3640)
600/630 min.	10pF	10 pF	100 pF	100 pF	100 pF	1000 pF	1000 pF	1000 pF	1000 pF
600/630 max.	330pF	1200 pF	2700 pF	3300 pF	5600 pF	0.012 $\mu$ F	0.012 $\mu$ F	0.018 $\mu$ F	0.047 $\mu$ F
1000 min.	10pF	10 pF	10 pF	100 pF	100 pF	100 pF	1000 pF	1000 pF	1000 pF
1000 max.	180pF	560 pF	1500 pF	2200 pF	3300 pF	8200 pF	0.010 $\mu$ F	0.010 $\mu$ F	0.022 $\mu$ F
1500 min.	—	10 pF	10 pF	10 pF	10 pF	100 pF	100 pF	100 pF	100 pF
1500 max.	—	270 pF	680 pF	820 pF	1800 pF	4700 pF	4700 pF	5600 pF	0.010 $\mu$ F
2000 min.	—	10 pF	10 pF	10 pF	10 pF	100 pF	100 pF	100 pF	100 pF
2000 max.	—	120 pF	270 pF	330 pF	1000 pF	1800 pF	2200 pF	2700 pF	6800 pF
2500 min.	—	—	—	10 pF	10 pF	10 pF	100 pF	100 pF	100 pF
2500 max.	—	—	—	180 pF	470 pF	1200 pF	1500 pF	1800 pF	3900 pF
3000 min.	—	—	—	10 pF	10 pF	10 pF	10 pF	10 pF	100 pF
3000 max.	—	—	—	120 pF	330 pF	820 pF	1000 pF	1200 pF	2700 pF
4000 min.	—	—	—	10 pF	10 pF	10 pF	10 pF	10 pF	100 pF
4000 max.	—	—	—	47 pF	150 pF	330 pF	470 pF	560 pF	1200 pF
5000 min.	—	—	—	—	—	—	10 pF	10 pF	10 pF
5000 max.	—	—	—	—	—	—	220 pF	270 pF	820 pF

## X7R Dielectric

### Performance Characteristics

<b>Capacitance Range</b>	10 pF to 0.56 $\mu$ F (25°C, 1.0 $\pm$ 0.2 Vrms at 1kHz)
<b>Capacitance Tolerances</b>	$\pm$ 10%; $\pm$ 20%; +80%, -20%
<b>Dissipation Factor</b>	2.5% max. (+25°C, 1.0 $\pm$ 0.2 Vrms, 1kHz)
<b>Operating Temperature Range</b>	-55°C to +125°C
<b>Temperature Characteristic</b>	$\pm$ 15% (0 VDC)
<b>Voltage Ratings</b>	600, 630, 1000, 1500, 2000, 2500, 3000, 4000 & 5000 VDC (+125°C)
<b>Insulation Resistance</b> (+25°C, at 500 VDC)	100K M $\Omega$ min. or 1000 M $\Omega$ - $\mu$ F min., whichever is less
<b>Insulation Resistance</b> (+125°C, at 500 VDC)	10K M $\Omega$ min. or 100 M $\Omega$ - $\mu$ F min., whichever is less
<b>Dielectric Strength</b>	Minimum 120% rated voltage for 5 seconds at 50 mA max. current

## HIGH VOLTAGE X7R MAXIMUM CAPACITANCE VALUES

VOLTAGE	0805	1206	1210	1808	1812	1825	2220	2225	3640
600/630 min.	100pF	1000 pF	1000 pF	1000 pF	1000 pF	0.010 $\mu$ F	0.010 $\mu$ F	0.010 $\mu$ F	0.010 $\mu$ F
600/630 max.	6800pF	0.022 $\mu$ F	0.056 $\mu$ F	0.068 $\mu$ F	0.120 $\mu$ F	0.270 $\mu$ F	0.270 $\mu$ F	0.330 $\mu$ F	0.560 $\mu$ F
1000 min.	100pF	100 pF	1000 pF	1000 pF	1000 pF	1000 pF	1000 pF	1000 pF	0.010 $\mu$ F
1000 max.	1500pF	6800 pF	0.015 $\mu$ F	0.018 $\mu$ F	0.039 $\mu$ F	0.100 $\mu$ F	0.120 $\mu$ F	0.150 $\mu$ F	0.220 $\mu$ F
1500 min.	—	100 pF	100 pF	100 pF	100 pF	1000 pF	1000 pF	1000 pF	1000 pF
1500 max.	—	2700 pF	5600 pF	6800 pF	0.015 $\mu$ F	0.056 $\mu$ F	0.056 $\mu$ F	0.068 $\mu$ F	0.100 $\mu$ F
2000 min.	—	10 pF	100 pF	100 pF	100 pF	100 pF	1000 pF	1000 pF	1000 pF
2000 max.	—	1500 pF	3300 pF	3300 pF	8200 pF	0.022 $\mu$ F	0.027 $\mu$ F	0.033 $\mu$ F	0.027 $\mu$ F
2500 min.	—	—	—	10 pF	10 pF	100 pF	100 pF	100 pF	1000 pF
2500 max.	—	—	—	2200 pF	5600 pF	0.015 $\mu$ F	0.018 $\mu$ F	0.022 $\mu$ F	0.022 $\mu$ F
3000 min.	—	—	—	10 pF	10 pF	100 pF	100 pF	100 pF	1000 pF
3000 max.	—	—	—	1800 pF	3900 pF	0.010 $\mu$ F	0.012 $\mu$ F	0.015 $\mu$ F	0.018 $\mu$ F
4000 min.	—	—	—	—	—	—	—	—	100 pF
4000 max.	—	—	—	—	—	—	—	—	6800 pF
5000 min.	—	—	—	—	—	—	—	—	100 pF
5000 max.	—	—	—	—	—	—	—	—	3300 pF

# High Voltage MLC Chips FLEXITERM®



For 600V to 3000V Applications

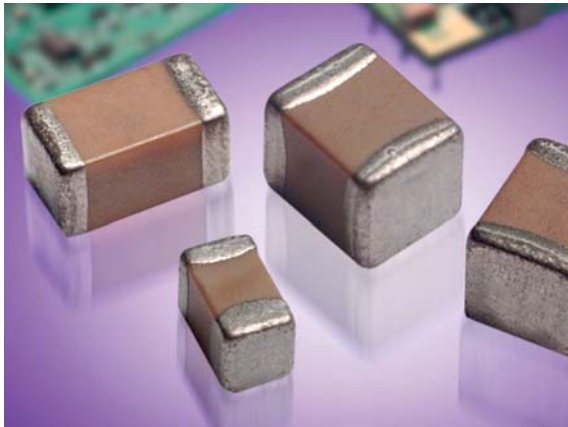

High value, low leakage and small size are difficult parameters to obtain in capacitors for high voltage systems. AVX special high voltage MLC chips capacitors meet these performance characteristics and are designed for applications such as snubbers in high frequency power converters, resonators in SMPS, and high voltage coupling/DC blocking. These high voltage chip designs exhibit low ESRs at high frequencies.

To make high voltage chips, larger physical sizes than are normally encountered are necessary. These larger sizes require that special precautions be taken in applying these chips in surface mount assemblies. In response to this, and to follow from the success of the FLEXITERM® range of low voltage parts, AVX is delighted to offer a FLEXITERM® high voltage range of capacitors, FLEXITERM®.

The FLEXITERM® layer is designed to enhance the mechanical flexure and temperature cycling performance of a standard ceramic capacitor, giving customers a solution where board flexure or temperature cycle damage are concerns.



## HOW TO ORDER

1808	A	C	272	K	A	Z	1	A
AVX Style	Voltage	Temperature Coefficient	Capacitance Code (2 significant digits + no. of zeros) Examples:	Capacitance Tolerance COG: J = ±5% K = ±10% M = ±20% X7R: K = ±10% M = ±20% Z = +80%, -20%	Test Level	Termination* Z = FLEXITERM® 100% Tin (RoHS Compliant)	Packaging 1 = 7" Reel 3 = 13" Reel 9 = Bulk	Special Code A = Standard
0805	600V/630V = C	COG = A	10 pF = 100					
1206	1000V = A	X7R = C	100 pF = 101					
1210	1500V = S		1,000 pF = 102					
1808	2000V = G		22,000 pF = 223					
1812	2500V = W		220,000 pF = 224					
1825	3000V = H		1 μF = 105					
2220								
2225								
***								

Notes: Capacitors with X7R dielectrics are not intended for applications across AC supply mains or AC line filtering with polarity reversal. Contact plant for recommendations. Contact factory for availability of Termination and Tolerance options for Specific Part Numbers.

\*\*\* AVX offers nonstandard chip sizes. Contact factory for details.

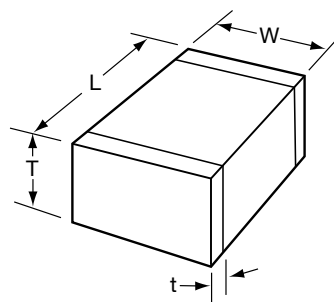

## DIMENSIONS

millimeters (inches)

SIZE	0805	1206	1210*	1808*	1812*	1825*	2220*	2225*
(L) Length	2.01 ± 0.20 (0.079 ± 0.008)	3.20 ± 0.20 (0.126 ± 0.008)	3.20 ± 0.20 (0.126 ± 0.008)	4.57 ± 0.25 (0.180 ± 0.010)	4.50 ± 0.30 (0.177 ± 0.012)	4.50 ± 0.30 (0.177 ± 0.012)	5.7 ± 0.40 (0.224 ± 0.016)	5.72 ± 0.25 (0.225 ± 0.010)
(W) Width	1.25 ± 0.20 (0.049 ± 0.008)	1.60 ± 0.20 (0.063 ± 0.008)	2.50 ± 0.20 (0.098 ± 0.008)	2.03 ± 0.25 (0.080 ± 0.010)	3.20 ± 0.20 (0.126 ± 0.008)	6.40 ± 0.30 (0.252 ± 0.012)	5.0 ± 0.40 (0.197 ± 0.016)	6.35 ± 0.25 (0.250 ± 0.010)
(T) Thickness Max.	1.30 (0.051)	1.52 (0.060)	1.70 (0.067)	2.03 (0.080)	2.54 (0.100)	2.54 (0.100)	3.30 (0.130)	2.54 (0.100)
(t) terminal min. max.	0.50 ± 0.25 (0.020 ± 0.010)	0.25 (0.010) 0.75 (0.030)	0.25 (0.010) 0.75 (0.030)	0.25 (0.010) 1.02 (0.040)	0.25 (0.010) 1.02 (0.040)	0.25 (0.010) 1.02 (0.040)	0.25 (0.010) 1.02 (0.040)	0.25 (0.010) 1.02 (0.040)

\*Reflow Soldering Only



# High Voltage MLC Chips FLEXITERM®



For 600V to 5000V Applications

## C0G Dielectric

### Performance Characteristics

<b>Capacitance Range</b>	10 pF to 0.018 µF (25°C, 1.0 ±0.2 Vrms at 1kHz, for ≤ 1000 pF use 1 MHz)
<b>Capacitance Tolerances</b>	±5%, ±10%, ±20%
<b>Dissipation Factor</b>	0.1% max. (+25°C, 1.0 ±0.2 Vrms, 1kHz, for ≤ 1000 pF use 1 MHz)
<b>Operating Temperature Range</b>	-55°C to +125°C
<b>Temperature Characteristic</b>	0 ±30 ppm/°C (0 VDC)
<b>Voltage Ratings</b>	600, 630, 1000, 1500, 2000, 2500, 3000, 4000 & 5000 VDC (+125°C)
<b>Insulation Resistance</b> (+25°C, at 500 VDC)	100K MΩ min. or 1000 MΩ - µF min., whichever is less
<b>Insulation Resistance</b> (+125°C, at 500 VDC)	10K MΩ min. or 100 MΩ - µF min., whichever is less
<b>Dielectric Strength</b>	Minimum 120% rated voltage for 5 seconds at 50 mA max. current

## HIGH VOLTAGE C0G CAPACITANCE VALUES

VOLTAGE	0805	1206	1210	1808	1812	1825	2220	2225
600/630 min.	10pF	10 pF	100 pF	100 pF	100 pF	1000 pF	1000 pF	1000 pF
600/630 max.	330pF	1200 pF	2700 pF	3300 pF	5600 pF	0.012 µF	0.012 µF	0.018 µF
1000 min.	10pF	10 pF	10 pF	100 pF	100 pF	100 pF	1000 pF	1000 pF
1000 max.	180pF	560 pF	1500 pF	2200 pF	3300 pF	8200 pF	0.010 µF	0.010 µF
1500 min.	—	10 pF	10 pF	10 pF	10 pF	100 pF	100 pF	100 pF
1500 max.	—	270 pF	680 pF	820 pF	1800 pF	4700 pF	4700 pF	5600 pF
2000 min.	—	10 pF	10 pF	10 pF	10 pF	100 pF	100 pF	100 pF
2000 max.	—	120 pF	270 pF	330 pF	1000 pF	1800 pF	2200 pF	2700 pF
2500 min.	—	—	—	10 pF	10 pF	10 pF	100 pF	100 pF
2500 max.	—	—	—	180 pF	470 pF	1200 pF	1500 pF	1800 pF
3000 min.	—	—	—	10 pF	10 pF	10 pF	10 pF	10 pF
3000 max.	—	—	—	120 pF	330 pF	820 pF	1000 pF	1200 pF
4000 min.	—	—	—	10 pF	10 pF	10 pF	10 pF	10 pF
4000 max.	—	—	—	47 pF	150 pF	330 pF	470 pF	560 pF
5000 min.	—	—	—	—	—	—	10 pF	10 pF
5000 max.	—	—	—	—	—	—	220 pF	270 pF

## X7R Dielectric

### Performance Characteristics

<b>Capacitance Range</b>	10 pF to 0.33 µF (25°C, 1.0 ±0.2 Vrms at 1kHz)
<b>Capacitance Tolerances</b>	±10%; ±20%; +80%, -20%
<b>Dissipation Factor</b>	2.5% max. (+25°C, 1.0 ±0.2 Vrms, 1kHz)
<b>Operating Temperature Range</b>	-55°C to +125°C
<b>Temperature Characteristic</b>	±15% (0 VDC)
<b>Voltage Ratings</b>	600, 630, 1000, 1500, 2000, 2500, 3000, 4000 & 5000 VDC (+125°C)
<b>Insulation Resistance</b> (+25°C, at 500 VDC)	100K MΩ min. or 1000 MΩ - µF min., whichever is less
<b>Insulation Resistance</b> (+125°C, at 500 VDC)	10K MΩ min. or 100 MΩ - µF min., whichever is less
<b>Dielectric Strength</b>	Minimum 120% rated voltage for 5 seconds at 50 mA max. current

## HIGH VOLTAGE X7R MAXIMUM CAPACITANCE VALUES

VOLTAGE	0805	1206	1210	1808	1812	1825	2220	2225
600/630 min.	100pF	1000 pF	1000 pF	1000 pF	1000 pF	0.010 µF	0.010 µF	0.010 µF
600/630 max.	6800pF	0.022 µF	0.056 µF	0.068 µF	0.120 µF	0.270 µF	0.270 µF	0.330 µF
1000 min.	100pF	100 pF	1000 pF	1000 pF	1000 pF	1000 pF	1000 pF	1000 pF
1000 max.	1500pF	6800 pF	0.015 µF	0.018 µF	0.039 µF	0.100 µF	0.120 µF	0.150 µF
1500 min.	—	100 pF	100 pF	100 pF	100 pF	1000 pF	1000 pF	1000 pF
1500 max.	—	2700 pF	5600 pF	6800 pF	0.015 µF	0.056 µF	0.056 µF	0.068 µF
2000 min.	—	10 pF	100 pF	100 pF	100 pF	100 pF	1000 pF	1000 pF
2000 max.	—	1500 pF	3300 pF	3300 pF	8200 pF	0.022 µF	0.027 µF	0.033 µF
2500 min.	—	—	—	10 pF	10 pF	100 pF	100 pF	100 pF
2500 max.	—	—	—	2200 pF	5600 pF	0.015 µF	0.018 µF	0.022 µF
3000 min.	—	—	—	10 pF	10 pF	100 pF	100 pF	100 pF
3000 max.	—	—	—	1800 pF	3900 pF	0.010 pF	0.012 µF	0.015 µF

# MIL-PRF-55681/Chips

Part Number Example  
CDR01 thru CDR06

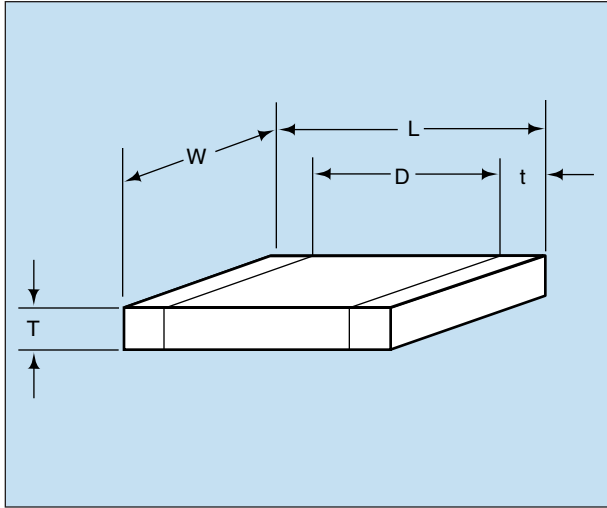

## MILITARY DESIGNATION PER MIL-PRF-55681

### Part Number Example

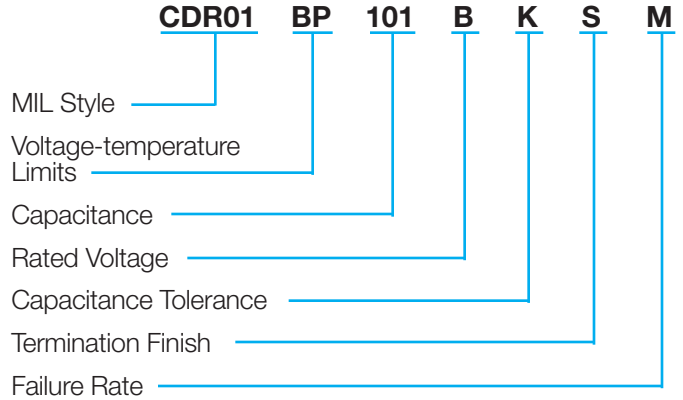

NOTE: Contact factory for availability of Termination and Tolerance Options for Specific Part Numbers.

**MIL Style:** CDR01, CDR02, CDR03, CDR04, CDR05, CDR06

### Voltage Temperature Limits:

BP =  $0 \pm 30$  ppm/°C without voltage;  $0 \pm 30$  ppm/°C with rated voltage from -55°C to +125°C

BX =  $\pm 15\%$  without voltage;  $+15 -25\%$  with rated voltage from -55°C to +125°C

**Capacitance:** Two digit figures followed by multiplier (number of zeros to be added) e.g., 101 = 100 pF

**Rated Voltage:** A = 50V, B = 100V

**Capacitance Tolerance:** J  $\pm 5\%$ , K  $\pm 10\%$ , M  $\pm 20\%$

### Termination Finish:

M = Palladium Silver  
 N = Silver Nickel Gold  
 S = Solder-coated

U = Base Metallization/Barrier Metal/Solder Coated\*  
 W = Base Metallization/Barrier Metal/Tinned (Tin or Tin/Lead Alloy)

\*Solder shall have a melting point of 200°C or less.

**Failure Rate Level:** M = 1.0%, P = .1%, R = .01%, S = .001%

**Packaging:** Bulk is standard packaging. Tape and reel per RS481 is available upon request.

**Not RoHS Compliant**

## CROSS REFERENCE: AVX/MIL-PRF-55681/CDR01 THRU CDR06\*

Per MIL-PRF-55681	AVX Style	Length (L)	Width (W)	Thickness (T)		D		Termination Band (t)	
				Min.	Max.	Min.	Max.	Min.	Max.
CDR01	0805	.080 $\pm$ .015	.050 $\pm$ .015	.022	.055	.030	—	.010	—
CDR02	1805	.180 $\pm$ .015	.050 $\pm$ .015	.022	.055	—	—	.010	.030
CDR03	1808	.180 $\pm$ .015	.080 $\pm$ .018	.022	.080	—	—	.010	.030
CDR04	1812	.180 $\pm$ .015	.125 $\pm$ .015	.022	.080	—	—	.010	.030
CDR05	1825	.180 $^{+.020}$ $_{-.015}$	.250 $^{+.020}$ $_{-.015}$	.020	.080	—	—	.010	.030
CDR06	2225	.225 $\pm$ .020	.250 $\pm$ .020	.020	.080	—	—	.010	.030

\*For CDR11, 12, 13, and 14 see AVX Microwave Chip Capacitor Catalog



# MIL-PRF-55681/Chips

## Military Part Number Identification

### CDR01 thru CDR06



#### CDR01 thru CDR06 to MIL-PRF-55681

Military Type Designation	Capacitance in pF	Capacitance tolerance	Rated temperature and voltage-temperature limits	WVDC
<b>AVX Style 0805/CDR01</b>				
CDR01BP100B---	10	J,K	BP	100
CDR01BP120B---	12	J	BP	100
CDR01BP150B---	15	J,K	BP	100
CDR01BP180B---	18	J	BP	100
CDR01BP220B---	22	J,K	BP	100
CDR01BP270B---	27	J	BP	100
CDR01BP330B---	33	J,K	BP	100
CDR01BP390B---	39	J	BP	100
CDR01BP470B---	47	J,K	BP	100
CDR01BP560B---	56	J	BP	100
CDR01BP680B---	68	J,K	BP	100
CDR01BP820B---	82	J	BP	100
CDR01BP101B---	100	J,K	BP	100
CDR01B--121B---	120	J,K	BP,BX	100
CDR01B--151B---	150	J,K	BP,BX	100
CDR01B--181B---	180	J,K	BP,BX	100
CDR01BX221B---	220	K,M	BX	100
CDR01BX271B---	270	K	BX	100
CDR01BX331B---	330	K,M	BX	100
CDR01BX391B---	390	K	BX	100
CDR01BX471B---	470	K,M	BX	100
CDR01BX561B---	560	K	BX	100
CDR01BX681B---	680	K,M	BX	100
CDR01BX821B---	820	K	BX	100
CDR01BX102B---	1000	K,M	BX	100
CDR01BX122B---	1200	K	BX	100
CDR01BX152B---	1500	K,M	BX	100
CDR01BX182B---	1800	K	BX	100
CDR01BX222B---	2200	K,M	BX	100
CDR01BX272B---	2700	K	BX	100
CDR01BX332B---	3300	K,M	BX	100
CDR01BX392A---	3900	K	BX	50
CDR01BX472A---	4700	K,M	BX	50
<b>AVX Style 1805/CDR02</b>				
CDR02BP221B---	220	J,K	BP	100
CDR02BP271B---	270	J	BP	100
CDR02BX392B---	3900	K	BX	100
CDR02BX472B---	4700	K,M	BX	100
CDR02BX562B---	5600	K	BX	100
CDR02BX682B---	6800	K,M	BX	100
CDR02BX822B---	8200	K	BX	100
CDR02BX103B---	10,000	K,M	BX	100
CDR02BX123A---	12,000	K	BX	50
CDR02BX153A---	15,000	K,M	BX	50
CDR02BX183A---	18,000	K	BX	50
CDR02BX223A---	22,000	K,M	BX	50

- Add appropriate failure rate
- Add appropriate termination finish
- Capacitance Tolerance

Military Type Designation	Capacitance in pF	Capacitance tolerance	Rated temperature and voltage-temperature limits	WVDC
<b>AVX Style 1808/CDR03</b>				
CDR03BP331B---	330	J,K	BP	100
CDR03BP391B---	390	J	BP	100
CDR03BP471B---	470	J,K	BP	100
CDR03BP561B---	560	J	BP	100
CDR03BP681B---	680	J,K	BP	100
CDR03BP821B---	820	J	BP	100
CDR03BP102B---	1000	J,K	BP	100
CDR03BX123B---	12,000	K	BX	100
CDR03BX153B---	15,000	K,M	BX	100
CDR03BX183B---	18,000	K	BX	100
CDR03BX223B---	22,000	K,M	BX	100
CDR03BX273B---	27,000	K	BX	100
CDR03BX333B---	33,000	K,M	BX	100
CDR03BX393A---	39,000	K	BX	50
CDR03BX473A---	47,000	K,M	BX	50
CDR03BX563A---	56,000	K	BX	50
CDR03BX683A---	68,000	K,M	BX	50
<b>AVX Style 1812/CDR04</b>				
CDR04BP122B---	1200	J	BP	100
CDR04BP152B---	1500	J,K	BP	100
CDR04BP182B---	1800	J	BP	100
CDR04BP222B---	2200	J,K	BP	100
CDR04BP272B---	2700	J	BP	100
CDR04BP332B---	3300	J,K	BP	100
CDR04BX393B---	39,000	K	BX	100
CDR04BX473B---	47,000	K,M	BX	100
CDR04BX563B---	56,000	K	BX	100
CDR04BX823A---	82,000	K	BX	50
CDR04BX104A---	100,000	K,M	BX	50
CDR04BX124A---	120,000	K	BX	50
CDR04BX154A---	150,000	K,M	BX	50
CDR04BX184A---	180,000	K	BX	50
<b>AVX Style 1825/CDR05</b>				
CDR05BP392B---	3900	J,K	BP	100
CDR05BP472B---	4700	J,K	BP	100
CDR05BP562B---	5600	J,K	BP	100
CDR05BX683B---	68,000	K,M	BX	100
CDR05BX823B---	82,000	K	BX	100
CDR05BX104B---	100,000	K,M	BX	100
CDR05BX124B---	120,000	K	BX	100
CDR05BX154B---	150,000	K,M	BX	100
CDR05BX224A---	220,000	K,M	BX	50
CDR05BX274A---	270,000	K	BX	50
CDR05BX334A---	330,000	K,M	BX	50
<b>AVX Style 2225/CDR06</b>				
CDR06BP682B---	6800	J,K	BP	100
CDR06BP822B---	8200	J,K	BP	100
CDR06BP103B---	10,000	J,K	BP	100
CDR06BX394A---	390,000	K	BX	50
CDR06BX474A---	470,000	K,M	BX	50

- Add appropriate failure rate
- Add appropriate termination finish
- Capacitance Tolerance



# MIL-PRF-55681/Chips

## Part Number Example

### CDR31 thru CDR35

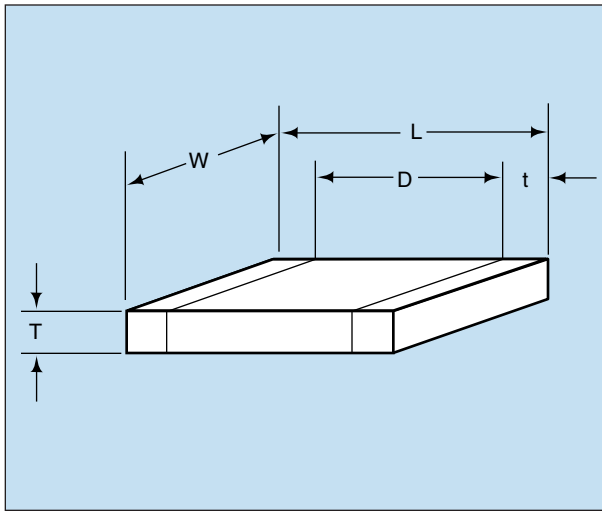

## MILITARY DESIGNATION PER MIL-PRF-55681

### Part Number Example

(example) **CDR31** **BP** **101** **B** **K** **S** **M**

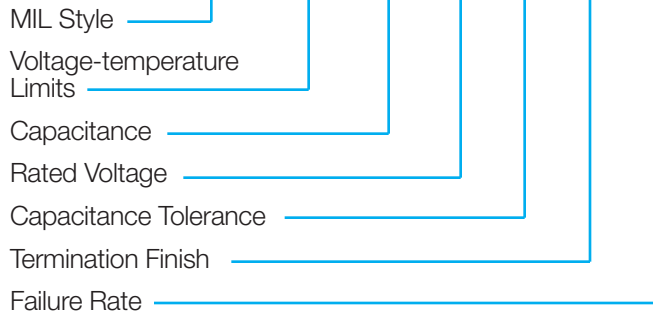

NOTE: Contact factory for availability of Termination and Tolerance Options for Specific Part Numbers.

**MIL Style:** CDR31, CDR32, CDR33, CDR34, CDR35

#### Voltage Temperature Limits:

BP =  $0 \pm 30$  ppm/°C without voltage;  $0 \pm 30$  ppm/°C with rated voltage from -55°C to +125°C

BX =  $\pm 15\%$  without voltage; +15 -25% with rated voltage from -55°C to +125°C

**Capacitance:** Two digit figures followed by multiplier (number of zeros to be added) e.g., 101 = 100 pF

**Rated Voltage:** A = 50V, B = 100V

**Capacitance Tolerance:** B  $\pm .10$  pF, C  $\pm .25$  pF, D  $\pm .5$  pF, F  $\pm 1\%$ , J  $\pm 5\%$ , K  $\pm 10\%$ , M  $\pm 20\%$

#### Termination Finish:

M = Palladium Silver  
N = Silver Nickel Gold  
S = Solder-coated  
Y = 100% Tin

U = Base Metallization/Barrier Metal/Solder Coated\*  
W = Base Metallization/Barrier Metal/Tinned (Tin or Tin/Lead Alloy)

\*Solder shall have a melting point of 200°C or less.

**Failure Rate Level:** M = 1.0%, P = .1%, R = .01%, S = .001%

**Packaging:** Bulk is standard packaging. Tape and reel per RS481 is available upon request.

**Not RoHS Compliant**

## CROSS REFERENCE: AVX/MIL-PRF-55681/CDR31 THRU CDR35

Per MIL-PRF-55681 (Metric Sizes)	AVX Style	Length (L) (mm)	Width (W) (mm)	Thickness (T)	D	Termination Band (t)	
				Max. (mm)		Min. (mm)	Max. (mm)
CDR31	0805	2.00	1.25	1.3	.50	.70	.30
CDR32	1206	3.20	1.60	1.3	—	.70	.30
CDR33	1210	3.20	2.50	1.5	—	.70	.30
CDR34	1812	4.50	3.20	1.5	—	.70	.30
CDR35	1825	4.50	6.40	1.5	—	.70	.30

# MIL-PRF-55681/Chips



## Military Part Number Identification CDR31

### CDR31 to MIL-PRF-55681/7

Military Type Designation 1/	Capacitance in pF	Capacitance tolerance	Rated temperature and voltage-temperature limits	WVDC
<b>AVX Style 0805/CDR31 (BP)</b>				
CDR31BP1R0B---	1.0	B,C	BP	100
CDR31BP1R1B---	1.1	B,C	BP	100
CDR31BP1R2B---	1.2	B,C	BP	100
CDR31BP1R3B---	1.3	B,C	BP	100
CDR31BP1R5B---	1.5	B,C	BP	100
CDR31BP1R6B---	1.6	B,C	BP	100
CDR31BP1R8B---	1.8	B,C	BP	100
CDR31BP2R0B---	2.0	B,C	BP	100
CDR31BP2R2B---	2.2	B,C	BP	100
CDR31BP2R4B---	2.4	B,C	BP	100
CDR31BP2R7B---	2.7	B,C,D	BP	100
CDR31BP3R0B---	3.0	B,C,D	BP	100
CDR31BP3R3B---	3.3	B,C,D	BP	100
CDR31BP3R6B---	3.6	B,C,D	BP	100
CDR31BP3R9B---	3.9	B,C,D	BP	100
CDR31BP4R3B---	4.3	B,C,D	BP	100
CDR31BP4R7B---	4.7	B,C,D	BP	100
CDR31BP5R1B---	5.1	B,C,D	BP	100
CDR31BP5R6B---	5.6	B,C,D	BP	100
CDR31BP6R2B---	6.2	B,C,D	BP	100
CDR31BP6R8B---	6.8	B,C,D	BP	100
CDR31BP7R5B---	7.5	B,C,D	BP	100
CDR31BP8R2B---	8.2	B,C,D	BP	100
CDR31BP9R1B---	9.1	B,C,D	BP	100
CDR31BP100B---	10	F,J,K	BP	100
CDR31BP110B---	11	F,J,K	BP	100
CDR31BP120B---	12	F,J,K	BP	100
CDR31BP130B---	13	F,J,K	BP	100
CDR31BP150B---	15	F,J,K	BP	100
CDR31BP160B---	16	F,J,K	BP	100
CDR31BP180B---	18	F,J,K	BP	100
CDR31BP200B---	20	F,J,K	BP	100
CDR31BP220B---	22	F,J,K	BP	100
CDR31BP240B---	24	F,J,K	BP	100
CDR31BP270B---	27	F,J,K	BP	100
CDR31BP300B---	30	F,J,K	BP	100
CDR31BP330B---	33	F,J,K	BP	100
CDR31BP360B---	36	F,J,K	BP	100
CDR31BP390B---	39	F,J,K	BP	100
CDR31BP430B---	43	F,J,K	BP	100
CDR31BP470B---	47	F,J,K	BP	100
CDR31BP510B---	51	F,J,K	BP	100
CDR31BP560B---	56	F,J,K	BP	100
CDR31BP620B---	62	F,J,K	BP	100
CDR31BP680B---	68	F,J,K	BP	100
CDR31BP750B---	75	F,J,K	BP	100
CDR31BP820B---	82	F,J,K	BP	100
CDR31BP910B---	91	F,J,K	BP	100

- Add appropriate failure rate
- Add appropriate termination finish
- Capacitance Tolerance

Military Type Designation 1/	Capacitance in pF	Capacitance tolerance	Rated temperature and voltage-temperature limits	WVDC
<b>AVX Style 0805/CDR31 (BP) cont'd</b>				
CDR31BP101B---	100	F,J,K	BP	100
CDR31BP111B---	110	F,J,K	BP	100
CDR31BP121B---	120	F,J,K	BP	100
CDR31BP131B---	130	F,J,K	BP	100
CDR31BP151B---	150	F,J,K	BP	100
CDR31BP161B---	160	F,J,K	BP	100
CDR31BP181B---	180	F,J,K	BP	100
CDR31BP201B---	200	F,J,K	BP	100
CDR31BP221B---	220	F,J,K	BP	100
CDR31BP241B---	240	F,J,K	BP	100
CDR31BP271B---	270	F,J,K	BP	100
CDR31BP301B---	300	F,J,K	BP	100
CDR31BP331B---	330	F,J,K	BP	100
CDR31BP361B---	360	F,J,K	BP	100
CDR31BP391B---	390	F,J,K	BP	100
CDR31BP431B---	430	F,J,K	BP	100
CDR31BP471B---	470	F,J,K	BP	100
CDR31BP511A---	510	F,J,K	BP	50
CDR31BP561A---	560	F,J,K	BP	50
CDR31BP621A---	620	F,J,K	BP	50
CDR31BP681A---	680	F,J,K	BP	50
<b>AVX Style 0805/CDR31 (BX)</b>				
CDR31BX471B---	470	K,M	BX	100
CDR31BX561B---	560	K,M	BX	100
CDR31BX681B---	680	K,M	BX	100
CDR31BX821B---	820	K,M	BX	100
CDR31BX102B---	1,000	K,M	BX	100
CDR31BX122B---	1,200	K,M	BX	100
CDR31BX152B---	1,500	K,M	BX	100
CDR31BX182B---	1,800	K,M	BX	100
CDR31BX222B---	2,200	K,M	BX	100
CDR31BX272B---	2,700	K,M	BX	100
CDR31BX332B---	3,300	K,M	BX	100
CDR31BX392B---	3,900	K,M	BX	100
CDR31BX472B---	4,700	K,M	BX	100
CDR31BX562A---	5,600	K,M	BX	50
CDR31BX682A---	6,800	K,M	BX	50
CDR31BX822A---	8,200	K,M	BX	50
CDR31BX103A---	10,000	K,M	BX	50
CDR31BX123A---	12,000	K,M	BX	50
CDR31BX153A---	15,000	K,M	BX	50
CDR31BX183A---	18,000	K,M	BX	50

- Add appropriate failure rate
- Add appropriate termination finish
- Capacitance Tolerance

1/ The complete part number will include additional symbols to indicate capacitance tolerance, termination and failure rate level.

# MIL-PRF-55681/Chips



## Military Part Number Identification CDR32

### CDR32 to MIL-PRF-55681/8

Military Type Designation <sup>1/</sup>	Capacitance in pF	Capacitance tolerance	Rated temperature and voltage-temperature limits	WVDC
<b>AVX Style 1206/CDR32 (BP)</b>				
CDR32BP1R0B---	1.0	B,C	BP	100
CDR32BP1R1B---	1.1	B,C	BP	100
CDR32BP1R2B---	1.2	B,C	BP	100
CDR32BP1R3B---	1.3	B,C	BP	100
CDR32BP1R5B---	1.5	B,C	BP	100
CDR32BP1R6B---	1.6	B,C	BP	100
CDR32BP1R8B---	1.8	B,C	BP	100
CDR32BP2R0B---	2.0	B,C	BP	100
CDR32BP2R2B---	2.2	B,C	BP	100
CDR32BP2R4B---	2.4	B,C	BP	100
CDR32BP2R7B---	2.7	B,C,D	BP	100
CDR32BP3R0B---	3.0	B,C,D	BP	100
CDR32BP3R3B---	3.3	B,C,D	BP	100
CDR32BP3R6B---	3.6	B,C,D	BP	100
CDR32BP3R9B---	3.9	B,C,D	BP	100
CDR32BP4R3B---	4.3	B,C,D	BP	100
CDR32BP4R7B---	4.7	B,C,D	BP	100
CDR32BP5R1B---	5.1	B,C,D	BP	100
CDR32BP5R6B---	5.6	B,C,D	BP	100
CDR32BP6R2B---	6.2	B,C,D	BP	100
CDR32BP6R8B---	6.8	B,C,D	BP	100
CDR32BP7R5B---	7.5	B,C,D	BP	100
CDR32BP8R2B---	8.2	B,C,D	BP	100
CDR32BP9R1B---	9.1	B,C,D	BP	100
CDR32BP100B---	10	F,J,K	BP	100
CDR32BP110B---	11	F,J,K	BP	100
CDR32BP120B---	12	F,J,K	BP	100
CDR32BP130B---	13	F,J,K	BP	100
CDR32BP150B---	15	F,J,K	BP	100
CDR32BP160B---	16	F,J,K	BP	100
CDR32BP180B---	18	F,J,K	BP	100
CDR32BP200B---	20	F,J,K	BP	100
CDR32BP220B---	22	F,J,K	BP	100
CDR32BP240B---	24	F,J,K	BP	100
CDR32BP270B---	27	F,J,K	BP	100
CDR32BP300B---	30	F,J,K	BP	100
CDR32BP330B---	33	F,J,K	BP	100
CDR32BP360B---	36	F,J,K	BP	100
CDR32BP390B---	39	F,J,K	BP	100
CDR32BP430B---	43	F,J,K	BP	100
CDR32BP470B---	47	F,J,K	BP	100
CDR32BP510B---	51	F,J,K	BP	100
CDR32BP560B---	56	F,J,K	BP	100
CDR32BP620B---	62	F,J,K	BP	100
CDR32BP680B---	68	F,J,K	BP	100
CDR32BP750B---	75	F,J,K	BP	100
CDR32BP820B---	82	F,J,K	BP	100
CDR32BP910B---	91	F,J,K	BP	100

- Add appropriate failure rate
- Add appropriate termination finish
- Capacitance Tolerance

Military Type Designation <sup>1/</sup>	Capacitance in pF	Capacitance tolerance	Rated temperature and voltage-temperature limits	WVDC
<b>AVX Style 1206/CDR32 (BP) cont'd</b>				
CDR32BP101B---	100	F,J,K	BP	100
CDR32BP111B---	110	F,J,K	BP	100
CDR32BP121B---	120	F,J,K	BP	100
CDR32BP131B---	130	F,J,K	BP	100
CDR32BP151B---	150	F,J,K	BP	100
CDR32BP161B---	160	F,J,K	BP	100
CDR32BP181B---	180	F,J,K	BP	100
CDR32BP201B---	200	F,J,K	BP	100
CDR32BP221B---	220	F,J,K	BP	100
CDR32BP241B---	240	F,J,K	BP	100
CDR32BP271B---	270	F,J,K	BP	100
CDR32BP301B---	300	F,J,K	BP	100
CDR32BP331B---	330	F,J,K	BP	100
CDR32BP361B---	360	F,J,K	BP	100
CDR32BP391B---	390	F,J,K	BP	100
CDR32BP431B---	430	F,J,K	BP	100
CDR32BP471B---	470	F,J,K	BP	100
CDR32BP511B---	510	F,J,K	BP	100
CDR32BP561B---	560	F,J,K	BP	100
CDR32BP621B---	620	F,J,K	BP	100
CDR32BP681B---	680	F,J,K	BP	100
CDR32BP751B---	750	F,J,K	BP	100
CDR32BP821B---	820	F,J,K	BP	100
CDR32BP911B---	910	F,J,K	BP	100
CDR32BP102B---	1,000	F,J,K	BP	100
CDR32BP112A---	1,100	F,J,K	BP	50
CDR32BP122A---	1,200	F,J,K	BP	50
CDR32BP132A---	1,300	F,J,K	BP	50
CDR32BP152A---	1,500	F,J,K	BP	50
CDR32BP162A---	1,600	F,J,K	BP	50
CDR32BP182A---	1,800	F,J,K	BP	50
CDR32BP202A---	2,000	F,J,K	BP	50
CDR32BP222A---	2,200	F,J,K	BP	50
<b>AVX Style 1206/CDR32 (BX)</b>				
CDR32BX472B---	4,700	K,M	BX	100
CDR32BX562B---	5,600	K,M	BX	100
CDR32BX682B---	6,800	K,M	BX	100
CDR32BX822B---	8,200	K,M	BX	100
CDR32BX103B---	10,000	K,M	BX	100
CDR32BX123B---	12,000	K,M	BX	100
CDR32BX153B---	15,000	K,M	BX	100
CDR32BX183A---	18,000	K,M	BX	50
CDR32BX223A---	22,000	K,M	BX	50
CDR32BX273A---	27,000	K,M	BX	50
CDR32BX333A---	33,000	K,M	BX	50
CDR32BX393A---	39,000	K,M	BX	50

- Add appropriate failure rate
- Add appropriate termination finish
- Capacitance Tolerance

<sup>1/</sup> The complete part number will include additional symbols to indicate capacitance tolerance, termination and failure rate level.

### CDR33/34/35 to MIL-PRF-55681/9/10/11

Military Type Designation <sup>1/</sup>	Capacitance in pF	Capacitance tolerance	Rated temperature and voltage-temperature limits	WVDC
<b>AVX Style 1210/CDR33 (BP)</b>				
CDR33BP102B---	1,000	F,J,K	BP	100
CDR33BP112B---	1,100	F,J,K	BP	100
CDR33BP122B---	1,200	F,J,K	BP	100
CDR33BP132B---	1,300	F,J,K	BP	100
CDR33BP152B---	1,500	F,J,K	BP	100
CDR33BP162B---	1,600	F,J,K	BP	100
CDR33BP182B---	1,800	F,J,K	BP	100
CDR33BP202B---	2,000	F,J,K	BP	100
CDR33BP222B---	2,200	F,J,K	BP	100
CDR33BP242A---	2,400	F,J,K	BP	50
CDR33BP272A---	2,700	F,J,K	BP	50
CDR33BP302A---	3,000	F,J,K	BP	50
CDR33BP332A---	3,300	F,J,K	BP	50
<b>AVX Style 1210/CDR33 (BX)</b>				
CDR33BX153B---	15,000	K,M	BX	100
CDR33BX183B---	18,000	K,M	BX	100
CDR33BX223B---	22,000	K,M	BX	100
CDR33BX273B---	27,000	K,M	BX	100
CDR33BX393A---	39,000	K,M	BX	50
CDR33BX473A---	47,000	K,M	BX	50
CDR33BX563A---	56,000	K,M	BX	50
CDR33BX683A---	68,000	K,M	BX	50
CDR33BX823A---	82,000	K,M	BX	50
CDR33BX104A---	100,000	K,M	BX	50
<b>AVX Style 1812/CDR34 (BP)</b>				
CDR34BP222B---	2,200	F,J,K	BP	100
CDR34BP242B---	2,400	F,J,K	BP	100
CDR34BP272B---	2,700	F,J,K	BP	100
CDR34BP302B---	3,000	F,J,K	BP	100
CDR34BP332B---	3,300	F,J,K	BP	100
CDR34BP362B---	3,600	F,J,K	BP	100
CDR34BP392B---	3,900	F,J,K	BP	100
CDR34BP432B---	4,300	F,J,K	BP	100
CDR34BP472B---	4,700	F,J,K	BP	100
CDR34BP512A---	5,100	F,J,K	BP	50
CDR34BP562A---	5,600	F,J,K	BP	50
CDR34BP622A---	6,200	F,J,K	BP	50
CDR34BP682A---	6,800	F,J,K	BP	50
CDR34BP752A---	7,500	F,J,K	BP	50
CDR34BP822A---	8,200	F,J,K	BP	50
CDR34BP912A---	9,100	F,J,K	BP	50
CDR34BP103A---	10,000	F,J,K	BP	50

- Add appropriate failure rate
- Add appropriate termination finish
- Capacitance Tolerance

Military Type Designation <sup>1/</sup>	Capacitance in pF	Capacitance tolerance	Rated temperature and voltage-temperature limits	WVDC
<b>AVX Style 1812/CDR34 (BX)</b>				
CDR34BX273B---	27,000	K,M	BX	100
CDR34BX333B---	33,000	K,M	BX	100
CDR34BX393B---	39,000	K,M	BX	100
CDR34BX473B---	47,000	K,M	BX	100
CDR34BX563B---	56,000	K,M	BX	100
CDR34BX104A---	100,000	K,M	BX	50
CDR34BX124A---	120,000	K,M	BX	50
CDR34BX154A---	150,000	K,M	BX	50
CDR34BX184A---	180,000	K,M	BX	50
<b>AVX Style 1825/CDR35 (BP)</b>				
CDR35BP472B---	4,700	F,J,K	BP	100
CDR35BP512B---	5,100	F,J,K	BP	100
CDR35BP562B---	5,600	F,J,K	BP	100
CDR35BP622B---	6,200	F,J,K	BP	100
CDR35BP682B---	6,800	F,J,K	BP	100
CDR35BP752B---	7,500	F,J,K	BP	100
CDR35BP822B---	8,200	F,J,K	BP	100
CDR35BP912B---	9,100	F,J,K	BP	100
CDR35BP103B---	10,000	F,J,K	BP	100
CDR35BP113A---	11,000	F,J,K	BP	50
CDR35BP123A---	12,000	F,J,K	BP	50
CDR35BP133A---	13,000	F,J,K	BP	50
CDR35BP153A---	15,000	F,J,K	BP	50
CDR35BP163A---	16,000	F,J,K	BP	50
CDR35BP183A---	18,000	F,J,K	BP	50
CDR35BP203A---	20,000	F,J,K	BP	50
CDR35BP223A---	22,000	F,J,K	BP	50
<b>AVX Style 1825/CDR35 (BX)</b>				
CDR35BX563B---	56,000	K,M	BX	100
CDR35BX683B---	68,000	K,M	BX	100
CDR35BX823B---	82,000	K,M	BX	100
CDR35BX104B---	100,000	K,M	BX	100
CDR35BX124B---	120,000	K,M	BX	100
CDR35BX154B---	150,000	K,M	BX	100
CDR35BX184A---	180,000	K,M	BX	50
CDR35BX224A---	220,000	K,M	BX	50
CDR35BX274A---	270,000	K,M	BX	50
CDR35BX334A---	330,000	K,M	BX	50
CDR35BX394A---	390,000	K,M	BX	50
CDR35BX474A---	470,000	K,M	BX	50

- Add appropriate failure rate
- Add appropriate termination finish
- Capacitance Tolerance

<sup>1/</sup> The complete part number will include additional symbols to indicate capacitance tolerance, termination and failure rate level.

# Packaging of Chip Components



## Automatic Insertion Packaging

### TAPE & REEL QUANTITIES

All tape and reel specifications are in compliance with RS481.

	8mm	12mm	
Paper or Embossed Carrier	0612, 0508, 0805, 1206, 1210		
Embossed Only		1808	1812, 1825 2220, 2225
Paper Only	0201, 0306, 0402, 0603		
Qty. per Reel/7" Reel	2,000, 3,000 or 4,000, 10,000, 15,000 Contact factory for exact quantity	3,000	500, 1,000 Contact factory for exact quantity
Qty. per Reel/13" Reel	5,000, 10,000, 50,000 Contact factory for exact quantity	10,000	4,000

### REEL DIMENSIONS

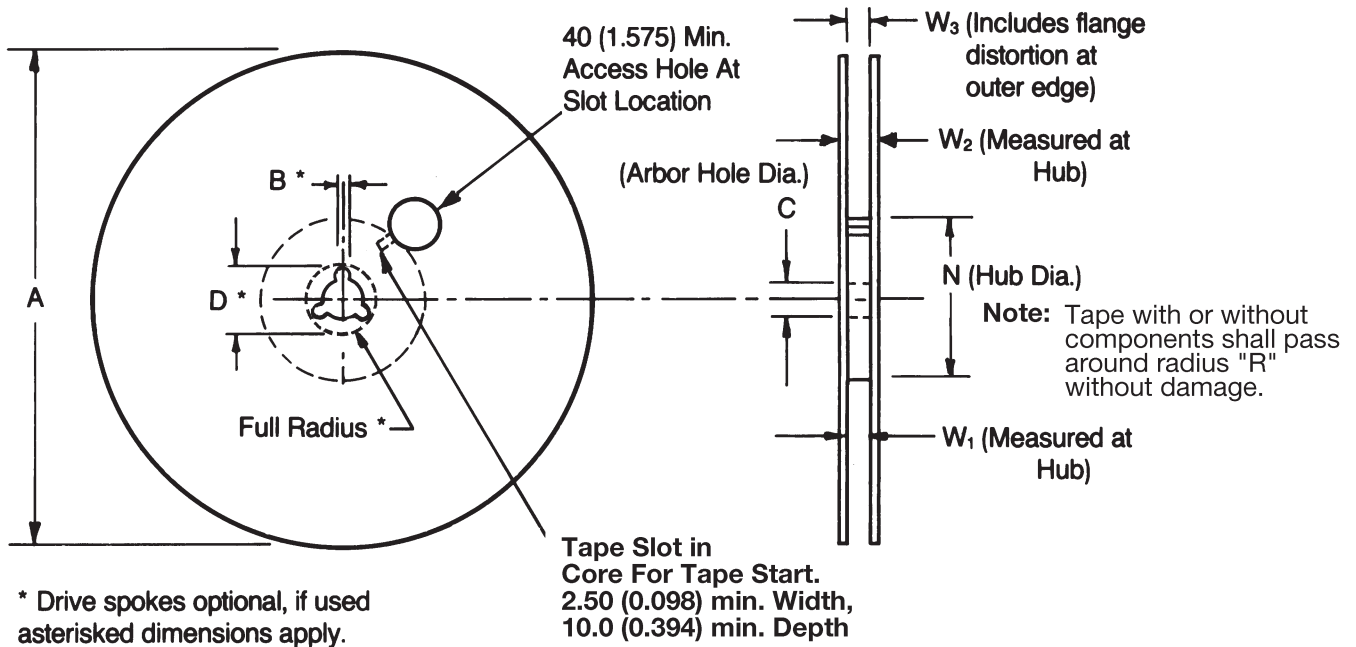

Tape Size <sup>(1)</sup>	A Max.	B* Min.	C	D* Min.	N Min.	W <sub>1</sub>	W <sub>2</sub> Max.	W <sub>3</sub>
8mm	330 (12.992)	1.5 (0.059)	13.0 <sup>+0.50</sup> <sub>-0.20</sub> (0.512 <sup>+0.020</sup> <sub>-0.008</sub> )	20.2 (0.795)	50.0 (1.969)	8.40 <sup>+1.5</sup> <sub>-0.8</sub> (0.331 <sup>+0.059</sup> <sub>-0.0</sub> )	14.4 (0.567)	7.90 Min. (0.311)
12mm						12.4 <sup>+2.0</sup> <sub>-0.0</sub> (0.488 <sup>+0.079</sup> <sub>-0.0</sub> )		11.9 Min. (0.469)
								10.9 Max. (0.429)
								15.4 Max. (0.607)

Metric dimensions will govern.

English measurements rounded and for reference only.

(1) For tape sizes 16mm and 24mm (used with chip size 3640) consult EIA RS-481 latest revision.

# Embossed Carrier Configuration



## 8 & 12mm Tape Only

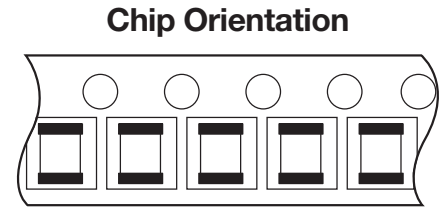
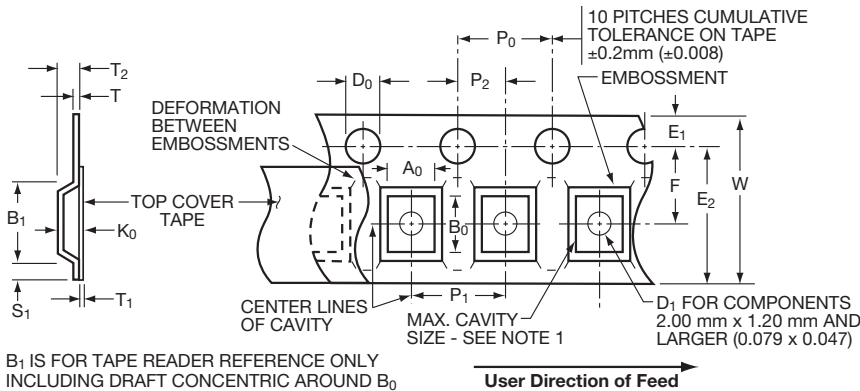

## 8 & 12mm Embossed Tape Metric Dimensions Will Govern

### CONSTANT DIMENSIONS

Tape Size	D <sub>0</sub>	E	P <sub>0</sub>	P <sub>2</sub>	S <sub>1</sub> Min.	T Max.	T <sub>1</sub>
8mm and 12mm	1.50 <sup>+0.10</sup> / <sub>0.0</sub> (0.059 <sup>+0.004</sup> / <sub>0.0</sub> )	1.75 ± 0.10 (0.069 ± 0.004)	4.0 ± 0.10 (0.157 ± 0.004)	2.0 ± 0.05 (0.079 ± 0.002)	0.60 (0.024)	0.60 (0.024)	0.10 (0.004) Max.

### VARIABLE DIMENSIONS

Tape Size	B <sub>1</sub> Max.	D <sub>1</sub> Min.	E <sub>2</sub> Min.	F	P <sub>1</sub> See Note 5	R Min. See Note 2	T <sub>2</sub>	W Max.	A <sub>0</sub> B <sub>0</sub> K <sub>0</sub>
8mm	4.35 (0.171)	1.00 (0.039)	6.25 (0.246)	3.50 ± 0.05 (0.138 ± 0.002)	4.00 ± 0.10 (0.157 ± 0.004)	25.0 (0.984)	2.50 Max. (0.098)	8.30 (0.327)	See Note 1
12mm	8.20 (0.323)	1.50 (0.059)	10.25 (0.404)	5.50 ± 0.05 (0.217 ± 0.002)	4.00 ± 0.10 (0.157 ± 0.004)	30.0 (1.181)	6.50 Max. (0.256)	12.3 (0.484)	See Note 1
8mm 1/2 Pitch	4.35 (0.171)	1.00 (0.039)	6.25 (0.246)	3.50 ± 0.05 (0.138 ± 0.002)	2.00 ± 0.10 (0.079 ± 0.004)	25.0 (0.984)	2.50 Max. (0.098)	8.30 (0.327)	See Note 1
12mm Double Pitch	8.20 (0.323)	1.50 (0.059)	10.25 (0.404)	5.50 ± 0.05 (0.217 ± 0.002)	8.00 ± 0.10 (0.315 ± 0.004)	30.0 (1.181)	6.50 Max. (0.256)	12.3 (0.484)	See Note 1

#### NOTES:

1. The cavity defined by A<sub>0</sub>, B<sub>0</sub>, and K<sub>0</sub> shall be configured to provide the following:

Surround the component with sufficient clearance such that:

- the component does not protrude beyond the sealing plane of the cover tape.
- the component can be removed from the cavity in a vertical direction without mechanical restriction, after the cover tape has been removed.
- rotation of the component is limited to 20° maximum (see Sketches D & E).
- lateral movement of the component is restricted to 0.5mm maximum (see Sketch F).

2. Tape with or without components shall pass around radius "R" without damage.

3. Bar code labeling (if required) shall be on the side of the reel opposite the round sprocket holes. Refer to EIA-556.

4. B<sub>1</sub> dimension is a reference dimension for tape feeder clearance only.

5. If P<sub>1</sub> = 2.0mm, the tape may not properly index in all tape feeders.

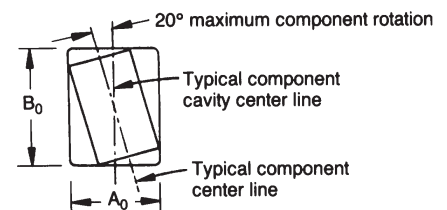
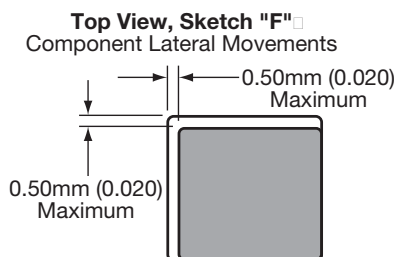
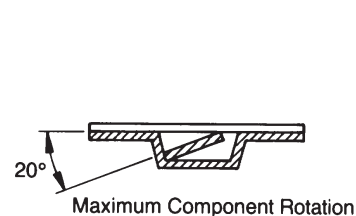

# Paper Carrier Configuration



## 8 & 12mm Tape Only

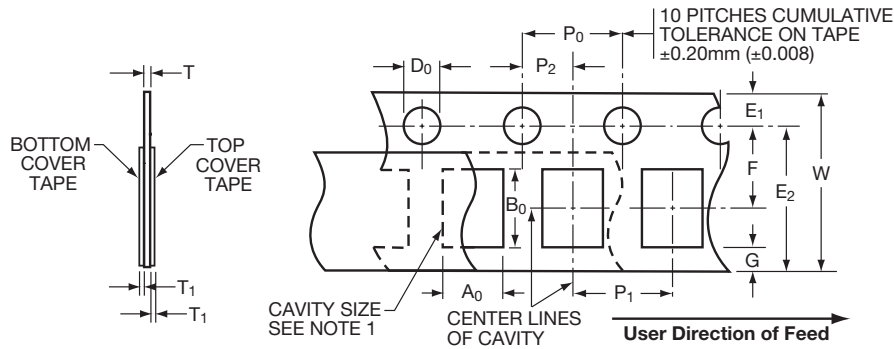

## 8 & 12mm Paper Tape Metric Dimensions Will Govern

### CONSTANT DIMENSIONS

Tape Size	D <sub>0</sub>	E	P <sub>0</sub>	P <sub>2</sub>	T <sub>1</sub>	G. Min.	R Min.
8mm and 12mm	1.50 <sup>+0.10</sup> / <sub>-0.004</sub> (0.059 <sup>+0.004</sup> / <sub>-0.004</sub> )	1.75 ± 0.10 (0.069 ± 0.004)	4.00 ± 0.10 (0.157 ± 0.004)	2.00 ± 0.05 (0.079 ± 0.002)	0.10 (0.004) Max.	0.75 (0.030) Min.	25.0 (0.984) See Note 2 Min.

### VARIABLE DIMENSIONS

Tape Size	P <sub>1</sub> See Note 4	E <sub>2</sub> Min.	F	W	A <sub>0</sub> B <sub>0</sub>	T
8mm	4.00 ± 0.10 (0.157 ± 0.004)	6.25 (0.246)	3.50 ± 0.05 (0.138 ± 0.002)	8.00 <sup>+0.30</sup> / <sub>-0.10</sub> (0.315 <sup>+0.012</sup> / <sub>-0.004</sub> )	See Note 1	1.10mm (0.043) Max. for Paper Base Tape and  1.60mm (0.063) Max. for Non-Paper Base Compositions
12mm	4.00 ± 0.010 (0.157 ± 0.004)	10.25 (0.404)	5.50 ± 0.05 (0.217 ± 0.002)	12.0 ± 0.30 (0.472 ± 0.012)		
8mm 1/2 Pitch	2.00 ± 0.05 (0.079 ± 0.002)	6.25 (0.246)	3.50 ± 0.05 (0.138 ± 0.002)	8.00 <sup>+0.30</sup> / <sub>-0.10</sub> (0.315 <sup>+0.012</sup> / <sub>-0.004</sub> )		
12mm Double Pitch	8.00 ± 0.10 (0.315 ± 0.004)	10.25 (0.404)	5.50 ± 0.05 (0.217 ± 0.002)	12.0 ± 0.30 (0.472 ± 0.012)		

#### NOTES:

- The cavity defined by A<sub>0</sub>, B<sub>0</sub>, and T shall be configured to provide sufficient clearance surrounding the component so that:
  - the component does not protrude beyond either surface of the carrier tape;
  - the component can be removed from the cavity in a vertical direction without mechanical restriction after the top cover tape has been removed;
  - rotation of the component is limited to 20° maximum (see Sketches A & B);
  - lateral movement of the component is restricted to 0.5mm maximum (see Sketch C).
- Tape with or without components shall pass around radius "R" without damage.
- Bar code labeling (if required) shall be on the side of the reel opposite the sprocket holes. Refer to EIA-556.
- If P<sub>1</sub> = 2.0mm, the tape may not properly index in all tape feeders.

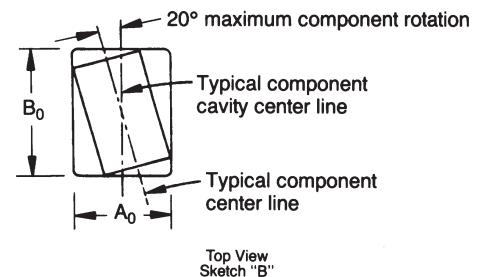
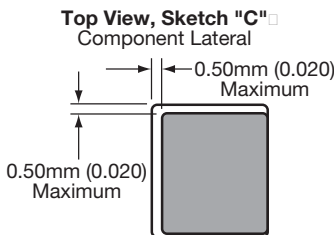
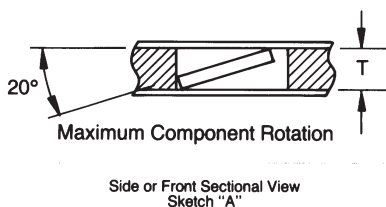

## Bar Code Labeling Standard

AVX bar code labeling is available and follows latest version of EIA-556





## BENEFITS

- Easier handling
- Smaller packaging volume  
(1/20 of T/R packaging)
- Easier inventory control
- Flexibility
- Recyclable

## CASE DIMENSIONS

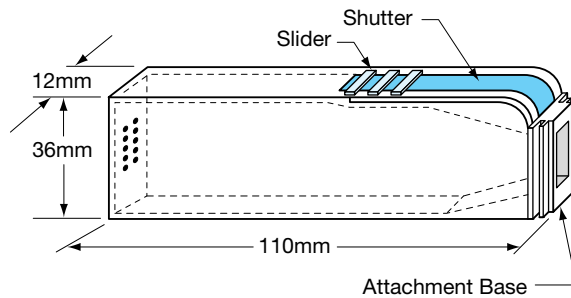

## BULK FEEDER

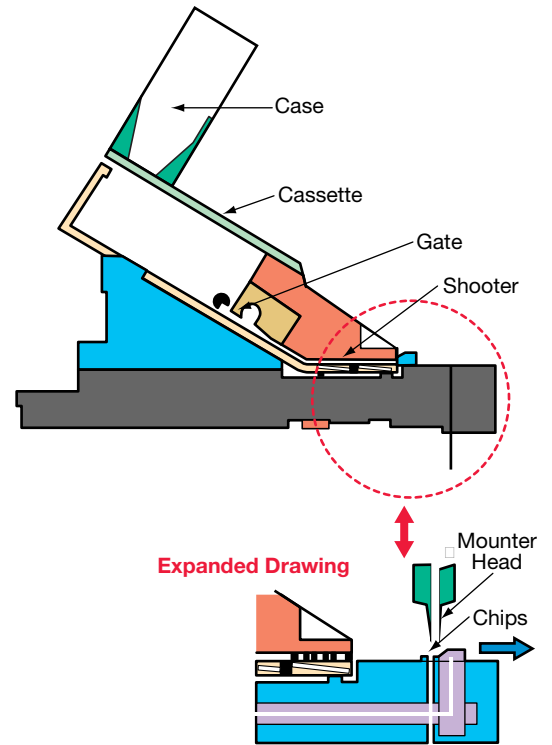

## CASE QUANTITIES

Part Size	0402	0603	0805	1206
Qty. (pcs / cassette)	80,000	15,000	10,000 (T=.023") 8,000 (T=.031") 6,000 (T=.043")	5,000 (T=.023") 4,000 (T=.032") 3,000 (T=.044")

## I. Capacitance (farads)

English:  $C = \frac{.224 \text{ K A}}{T_D}$

Metric:  $C = \frac{.0884 \text{ K A}}{T_D}$

## II. Energy stored in capacitors (Joules, watt - sec)

$E = \frac{1}{2} CV^2$

## III. Linear charge of a capacitor (Amperes)

$I = C \frac{dV}{dt}$

## IV. Total Impedance of a capacitor (ohms)

$Z = \sqrt{R_S^2 + (X_C - X_L)^2}$

## V. Capacitive Reactance (ohms)

$X_C = \frac{1}{2 \pi fC}$

## VI. Inductive Reactance (ohms)

$X_L = 2 \pi fL$

## VII. Phase Angles:

Ideal Capacitors: Current leads voltage 90°

Ideal Inductors: Current lags voltage 90°

Ideal Resistors: Current in phase with voltage

## VIII. Dissipation Factor (%)

D.F. =  $\tan \delta$  (loss angle) =  $\frac{E.S.R.}{X_C} = (2 \pi fC) (E.S.R.)$

## IX. Power Factor (%)

P.F. =  $\text{Sine } \delta$  (loss angle) =  $\text{Cos } \phi$  (phase angle)

P.F. = (when less than 10%) = DF

## X. Quality Factor (dimensionless)

$Q = \text{Cotan } \delta$  (loss angle) =  $\frac{1}{D.F.}$

## XI. Equivalent Series Resistance (ohms)

E.S.R. = (D.F.) (Xc) = (D.F.) / (2 π fC)

## XII. Power Loss (watts)

Power Loss = (2 π fCV²) (D.F.)

## XIII. KVA (Kilowatts)

KVA = 2 π fCV² x 10<sup>-3</sup>

## XIV. Temperature Characteristic (ppm/°C)

T.C. =  $\frac{C_t - C_{25}}{C_{25} (T_t - 25)} \times 10^6$

## XV. Cap Drift (%)

C.D. =  $\frac{C_1 - C_2}{C_1} \times 100$

## XVI. Reliability of Ceramic Capacitors

$L_t = \left( \frac{V_t}{V_o} \right)^X \left( \frac{T_t}{T_o} \right)^Y$

## XVII. Capacitors in Series (current the same)

Any Number:  $\frac{1}{C_T} = \frac{1}{C_1} + \frac{1}{C_2} \dots \frac{1}{C_N}$

Two:  $C_T = \frac{C_1 C_2}{C_1 + C_2}$

## XVIII. Capacitors in Parallel (voltage the same)

$C_T = C_1 + C_2 \dots + C_N$

## XIX. Aging Rate

A.R. = %Δ C/decade of time

## XX. Decibels

db = 20 log  $\frac{V_1}{V_2}$

## METRIC PREFIXES

## SYMBOLS

Pico	X 10 <sup>-12</sup>	K	= Dielectric Constant	f	= frequency	L <sub>t</sub>	= Test life
Nano	X 10 <sup>-9</sup>	A	= Area	L	= Inductance	V <sub>t</sub>	= Test voltage
Micro	X 10 <sup>-6</sup>	T <sub>D</sub>	= Dielectric thickness	δ	= Loss angle	V <sub>O</sub>	= Operating voltage
Milli	X 10 <sup>-3</sup>	V	= Voltage	φ	= Phase angle	T <sub>t</sub>	= Test temperature
Deci	X 10 <sup>-1</sup>	t	= time	X & Y	= exponent effect of voltage and temp.	T <sub>O</sub>	= Operating temperature
Deca	X 10 <sup>+1</sup>	R <sub>S</sub>	= Series Resistance	L <sub>O</sub>	= Operating life		
Kilo	X 10 <sup>+3</sup>						
Mega	X 10 <sup>+6</sup>						
Giga	X 10 <sup>+9</sup>						
Tera	X 10 <sup>+12</sup>						

**Basic Construction** – A multilayer ceramic (MLC) capacitor is a monolithic block of ceramic containing two sets of offset, interleaved planar electrodes that extend to two opposite surfaces of the ceramic dielectric. This simple

structure requires a considerable amount of sophistication, both in material and manufacture, to produce it in the quality and quantities needed in today's electronic equipment.

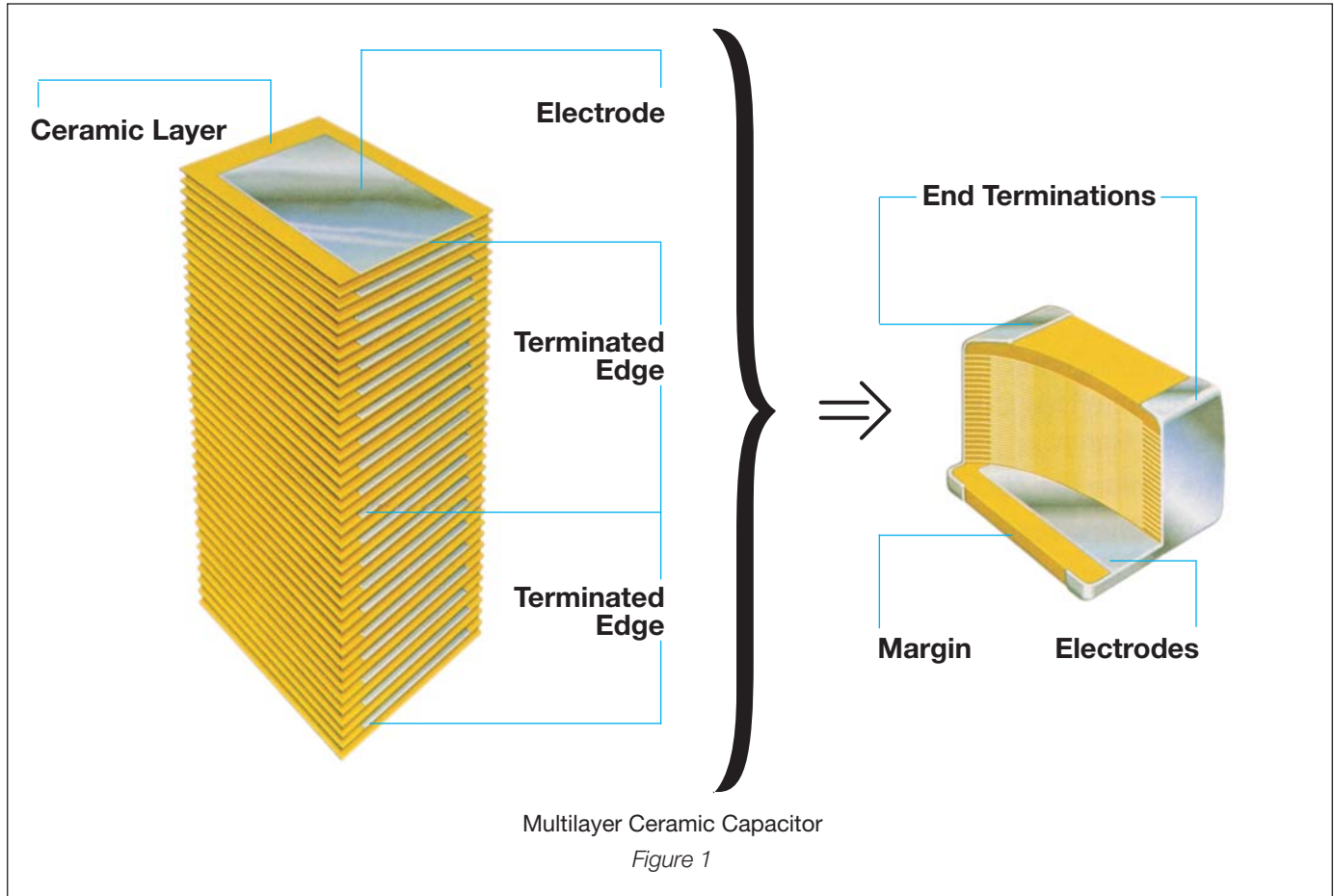

**Formulations** – Multilayer ceramic capacitors are available in both Class 1 and Class 2 formulations. Temperature compensating formulations are Class 1 and temperature stable and general application formulations are classified as Class 2.

**Class 1** – Class 1 capacitors or temperature compensating capacitors are usually made from mixtures of titanates where barium titanate is normally not a major part of the mix. They have predictable temperature coefficients and in general, do not have an aging characteristic. Thus they are the most stable capacitor available. The most popular Class 1 multilayer ceramic capacitors are C0G (NP0) temperature compensating capacitors (negative-positive 0 ppm/°C).

**Class 2** – EIA Class 2 capacitors typically are based on the chemistry of barium titanate and provide a wide range of capacitance values and temperature stability. The most commonly used Class 2 dielectrics are X7R and Y5V. The X7R provides intermediate capacitance values which vary only  $\pm 15\%$  over the temperature range of  $-55^{\circ}\text{C}$  to  $125^{\circ}\text{C}$ . It finds applications where stability over a wide temperature range is required.

The Y5V provides the highest capacitance values and is used in applications where limited temperature changes are expected. The capacitance value for Y5V can vary from 22% to -82% over the  $-30^{\circ}\text{C}$  to  $85^{\circ}\text{C}$  temperature range.

All Class 2 capacitors vary in capacitance value under the influence of temperature, operating voltage (both AC and DC), and frequency. For additional information on performance changes with operating conditions, consult AVX's software, SpiCap.

**Table 1: EIA and MIL Temperature Stable and General Application Codes**

<b>EIA CODE</b>	
<b>Percent Capacity Change Over Temperature Range</b>	
<b>RS198</b>	<b>Temperature Range</b>
X7	-55°C to +125°C
X6	-55°C to +105°C
X5	-55°C to +85°C
Y5	-30°C to +85°C
Z5	+10°C to +85°C
<b>Code</b>	<b>Percent Capacity Change</b>
D	±3.3%
E	±4.7%
F	±7.5%
P	±10%
R	±15%
S	±22%
T	+22%, -33%
U	+22%, -56%
V	+22%, -82%

EXAMPLE – A capacitor is desired with the capacitance value at 25°C to increase no more than 7.5% or decrease no more than 7.5% from -30°C to +85°C. EIA Code will be Y5F.

<b>MIL CODE</b>		
<b>Symbol</b>	<b>Temperature Range</b>	
A	-55°C to +85°C	
B	-55°C to +125°C	
C	-55°C to +150°C	
<b>Symbol</b>	<b>Cap. Change Zero Volts</b>	<b>Cap. Change Rated Volts</b>
R	+15%, -15%	+15%, -40%
S	+22%, -22%	+22%, -56%
W	+22%, -56%	+22%, -66%
X	+15%, -15%	+15%, -25%
Y	+30%, -70%	+30%, -80%
Z	+20%, -20%	+20%, -30%

Temperature characteristic is specified by combining range and change symbols, for example BR or AW. Specification slash sheets indicate the characteristic applicable to a given style of capacitor.

In specifying capacitance change with temperature for Class 2 materials, EIA expresses the capacitance change over an operating temperature range by a 3 symbol code. The first symbol represents the cold temperature end of the temperature range, the second represents the upper limit of the operating temperature range and the third symbol represents the capacitance change allowed over the operating temperature range. Table 1 provides a detailed explanation of the EIA system.

**Effects of Voltage** – Variations in voltage have little effect on Class 1 dielectric but does affect the capacitance and dissipation factor of Class 2 dielectrics. The application of DC voltage reduces both the capacitance and dissipation factor while the application of an AC voltage within a reasonable range tends to increase both capacitance and dissipation factor readings. If a high enough AC voltage is applied, eventually it will reduce capacitance just as a DC voltage will. Figure 2 shows the effects of AC voltage.

**Cap. Change vs. A.C. Volts  
X7R**

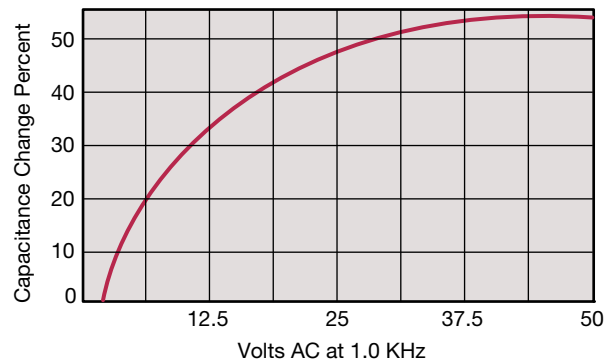

Figure 2

Capacitor specifications specify the AC voltage at which to measure (normally 0.5 or 1 VAC) and application of the wrong voltage can cause spurious readings. Figure 3 gives the voltage coefficient of dissipation factor for various AC voltages at 1 kilohertz. Applications of different frequencies will affect the percentage changes versus voltages.

**D.F. vs. A.C. Measurement Volts  
X7R**

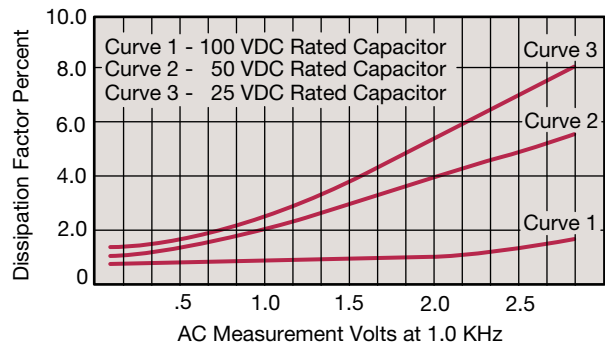

Figure 3

Typical effect of the application of DC voltage is shown in Figure 4. The voltage coefficient is more pronounced for higher K dielectrics. These figures are shown for room temperature conditions. The combination characteristic known as voltage temperature limits which shows the effects of rated voltage over the operating temperature range is shown in Figure 5 for the military BX characteristic.

**Typical Cap. Change vs. D.C. Volts  
X7R**

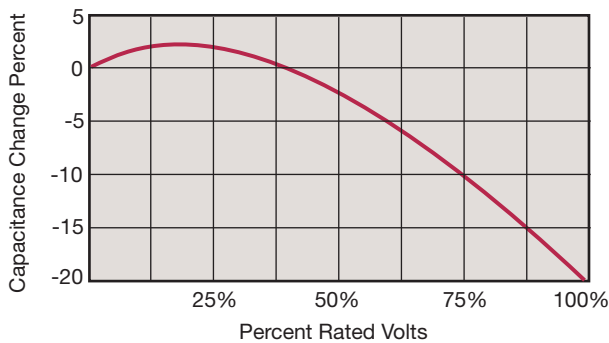

Figure 4

**Typical Cap. Change vs. Temperature  
X7R**

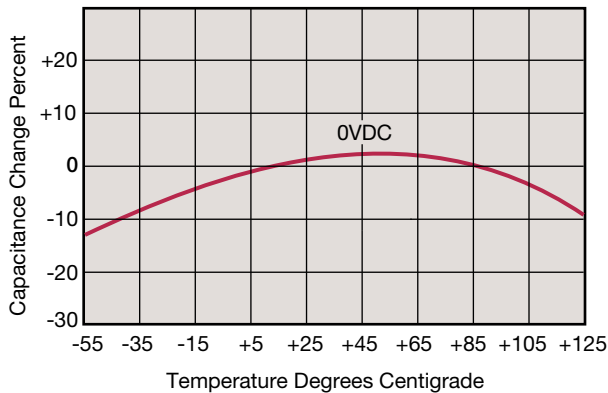

Figure 5

**Effects of Time** – Class 2 ceramic capacitors change capacitance and dissipation factor with time as well as temperature, voltage and frequency. This change with time is known as aging. Aging is caused by a gradual re-alignment of the crystalline structure of the ceramic and produces an exponential loss in capacitance and decrease in dissipation factor versus time. A typical curve of aging rate for semistable ceramics is shown in Figure 6.

If a Class 2 ceramic capacitor that has been sitting on the shelf for a period of time, is heated above its curie point, (125°C for 4 hours or 150°C for ½ hour will suffice) the part will de-age and return to its initial capacitance and dissipation factor readings. Because the capacitance changes rapidly, immediately after de-aging, the basic capacitance measurements are normally referred to a time period sometime after the de-aging process. Various manufacturers use different time bases but the most popular one is one day or twenty-four hours after “last heat.” Change in the aging curve can be caused by the application of voltage and other stresses. The possible changes in capacitance due to de-aging by heating the unit explain why capacitance changes are allowed after test, such as temperature cycling, moisture resistance, etc., in MIL specs. The application of high voltages such as dielectric withstanding voltages also tends to de-age

capacitors and is why re-reading of capacitance after 12 or 24 hours is allowed in military specifications after dielectric strength tests have been performed.

**Typical Curve of Aging Rate  
X7R**

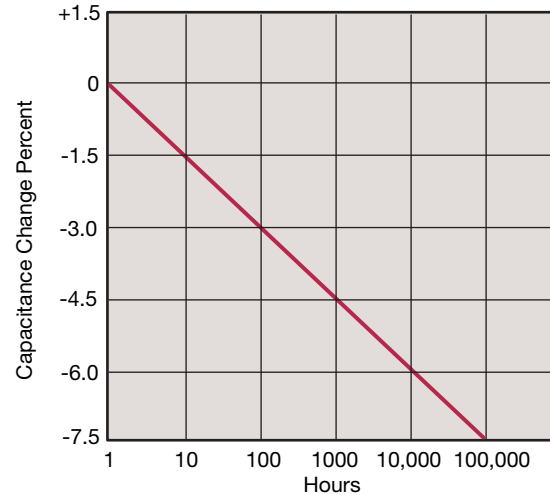

Characteristic	Max. Aging Rate %/Decade
C0G (NP0)	None
X7R, X5R	2
Y5V	7

Figure 6

**Effects of Frequency** – Frequency affects capacitance and impedance characteristics of capacitors. This effect is much more pronounced in high dielectric constant ceramic formulation than in low K formulations. AVX’s SpiCap software generates impedance, ESR, series inductance, series resonant frequency and capacitance all as functions of frequency, temperature and DC bias for standard chip sizes and styles. It is available free from AVX and can be downloaded for free from AVX website: [www.avx.com](http://www.avx.com).



**Effects of Mechanical Stress** – High “K” dielectric ceramic capacitors exhibit some low level piezoelectric reactions under mechanical stress. As a general statement, the piezoelectric output is higher, the higher the dielectric constant of the ceramic. It is desirable to investigate this effect before using high “K” dielectrics as coupling capacitors in extremely low level applications.

**Reliability** – Historically ceramic capacitors have been one of the most reliable types of capacitors in use today. The approximate formula for the reliability of a ceramic capacitor is:

$$\frac{L_o}{L_t} = \left(\frac{V_t}{V_o}\right)^X \left(\frac{T_t}{T_o}\right)^Y$$

where

$L_o$  = operating life                       $T_t$  = test temperature and  
 $L_t$  = test life                               $T_o$  = operating temperature  
 $V_t$  = test voltage                              in °C  
 $V_o$  = operating voltage                       $X, Y$  = see text

Historically for ceramic capacitors exponent X has been considered as 3. The exponent Y for temperature effects typically tends to run about 8.

A capacitor is a component which is capable of storing electrical energy. It consists of two conductive plates (electrodes) separated by insulating material which is called the dielectric. A typical formula for determining capacitance is:

$$C = \frac{.224 KA}{t}$$

$C$  = capacitance (picofarads)  
 $K$  = dielectric constant (Vacuum = 1)  
 $A$  = area in square inches  
 $t$  = separation between the plates in inches  
 (thickness of dielectric)  
 $.224$  = conversion constant  
 (.0884 for metric system in cm)

**Capacitance** – The standard unit of capacitance is the farad. A capacitor has a capacitance of 1 farad when 1 coulomb charges it to 1 volt. One farad is a very large unit and most capacitors have values in the micro ( $10^{-6}$ ), nano ( $10^{-9}$ ) or pico ( $10^{-12}$ ) farad level.

**Dielectric Constant** – In the formula for capacitance given above the dielectric constant of a vacuum is arbitrarily chosen as the number 1. Dielectric constants of other materials are then compared to the dielectric constant of a vacuum.

**Dielectric Thickness** – Capacitance is indirectly proportional to the separation between electrodes. Lower voltage requirements mean thinner dielectrics and greater capacitance per volume.

**Area** – Capacitance is directly proportional to the area of the electrodes. Since the other variables in the equation are usually set by the performance desired, area is the easiest parameter to modify to obtain a specific capacitance within a material group.

**Energy Stored** – The energy which can be stored in a capacitor is given by the formula:

$$E = \frac{1}{2}CV^2$$

$E$  = energy in joules (watts-sec)  
 $V$  = applied voltage  
 $C$  = capacitance in farads

**Potential Change** – A capacitor is a reactive component which reacts against a change in potential across it. This is shown by the equation for the linear charge of a capacitor:

$$I_{ideal} = C \frac{dV}{dt}$$

where

$I$  = Current  
 $C$  = Capacitance  
 $dV/dt$  = Slope of voltage transition across capacitor

Thus an infinite current would be required to instantly change the potential across a capacitor. The amount of current a capacitor can “sink” is determined by the above equation.

**Equivalent Circuit** – A capacitor, as a practical device, exhibits not only capacitance but also resistance and inductance. A simplified schematic for the equivalent circuit is:

$C$  = Capacitance                               $L$  = Inductance

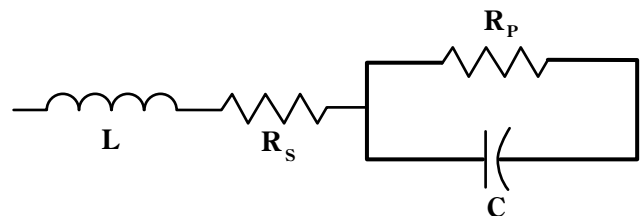

$R_s$  = Series Resistance                       $R_p$  = Parallel Resistance

**Reactance** – Since the insulation resistance ( $R_p$ ) is normally very high, the total impedance of a capacitor is:

$$Z = \sqrt{R_s^2 + (X_C - X_L)^2}$$

where

$Z$  = Total Impedance  
 $R_s$  = Series Resistance  
 $X_C$  = Capacitive Reactance =  $\frac{1}{2 \pi f C}$   
 $X_L$  = Inductive Reactance =  $2 \pi f L$

The variation of a capacitor’s impedance with frequency determines its effectiveness in many applications.

**Phase Angle** – Power Factor and Dissipation Factor are often confused since they are both measures of the loss in a capacitor under AC application and are often almost identical in value. In a “perfect” capacitor the current in the capacitor will lead the voltage by 90°.

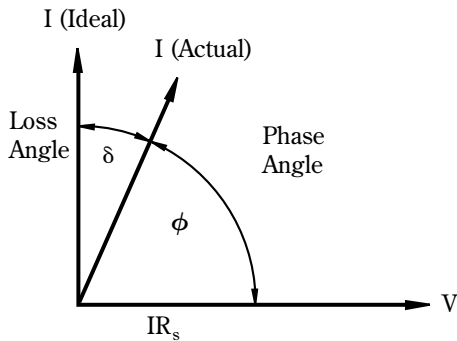

In practice the current leads the voltage by some other phase angle due to the series resistance  $R_s$ . The complement of this angle is called the loss angle and:

$$\text{Power Factor (P.F.)} = \cos \phi \text{ or } \sin \delta$$

$$\text{Dissipation Factor (D.F.)} = \tan \delta$$

for small values of  $\delta$  the tan and sine are essentially equal which has led to the common interchangeability of the two terms in the industry.

**Equivalent Series Resistance** – The term E.S.R. or Equivalent Series Resistance combines all losses both series and parallel in a capacitor at a given frequency so that the equivalent circuit is reduced to a simple R-C series connection.

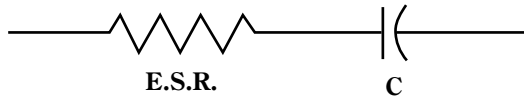

**Dissipation Factor** – The DF/PF of a capacitor tells what percent of the apparent power input will turn to heat in the capacitor.

$$\text{Dissipation Factor} = \frac{\text{E.S.R.}}{X_C} = (2 \pi fC) (\text{E.S.R.})$$

The watts loss are:

$$\text{Watts loss} = (2 \pi fCV^2) (\text{D.F.})$$

Very low values of dissipation factor are expressed as their reciprocal for convenience. These are called the “Q” or Quality factor of capacitors.

**Parasitic Inductance** – The parasitic inductance of capacitors is becoming more and more important in the decoupling of today’s high speed digital systems. The relationship between the inductance and the ripple voltage induced on the DC voltage line can be seen from the simple inductance equation:

$$V = L \frac{di}{dt}$$

The  $\frac{di}{dt}$  seen in current microprocessors can be as high as 0.3 A/ns, and up to 10A/ns. At 0.3 A/ns, 100pH of parasitic inductance can cause a voltage spike of 30mV. While this does not sound very drastic, with the  $V_{cc}$  for microprocessors decreasing at the current rate, this can be a fairly large percentage.

Another important, often overlooked, reason for knowing the parasitic inductance is the calculation of the resonant frequency. This can be important for high frequency, bypass capacitors, as the resonant point will give the most signal attenuation. The resonant frequency is calculated from the simple equation:

$$f_{res} = \frac{1}{2\pi\sqrt{LC}}$$

**Insulation Resistance** – Insulation Resistance is the resistance measured across the terminals of a capacitor and consists principally of the parallel resistance  $R_P$  shown in the equivalent circuit. As capacitance values and hence the area of dielectric increases, the I.R. decreases and hence the product ( $C \times IR$  or  $RC$ ) is often specified in ohm farads or more commonly megohm-microfarads. Leakage current is determined by dividing the rated voltage by IR (Ohm’s Law).

**Dielectric Strength** – Dielectric Strength is an expression of the ability of a material to withstand an electrical stress. Although dielectric strength is ordinarily expressed in volts, it is actually dependent on the thickness of the dielectric and thus is also more generically a function of volts/mil.

**Dielectric Absorption** – A capacitor does not discharge instantaneously upon application of a short circuit, but drains gradually after the capacitance proper has been discharged. It is common practice to measure the dielectric absorption by determining the “reappearing voltage” which appears across a capacitor at some point in time after it has been fully discharged under short circuit conditions.

**Corona** – Corona is the ionization of air or other vapors which causes them to conduct current. It is especially prevalent in high voltage units but can occur with low voltages as well where high voltage gradients occur. The energy discharged degrades the performance of the capacitor and can in time cause catastrophic failures.

# Surface Mounting Guide



## MLC Chip Capacitors

### REFLOW SOLDERING

Case Size	D1	D2	D3	D4	D5
0201	0.85 (0.033)	0.30 (0.012)	0.25 (0.010)	0.30 (0.012)	0.35 (0.014)
0402	1.70 (0.067)	0.60 (0.024)	0.50 (0.020)	0.60 (0.024)	0.50 (0.020)
0603	2.30 (0.091)	0.80 (0.031)	0.70 (0.028)	0.80 (0.031)	0.75 (0.030)
0805	3.00 (0.118)	1.00 (0.039)	1.00 (0.039)	1.00 (0.039)	1.25 (0.049)
1206	4.00 (0.157)	1.00 (0.039)	2.00 (0.079)	1.00 (0.039)	1.60 (0.063)
1210	4.00 (0.157)	1.00 (0.039)	2.00 (0.079)	1.00 (0.039)	2.50 (0.098)
1808	5.60 (0.220)	1.00 (0.039)	3.60 (0.142)	1.00 (0.039)	2.00 (0.079)
1812	5.60 (0.220)	1.00 (0.039)	3.60 (0.142)	1.00 (0.039)	3.00 (0.118)
1825	5.60 (0.220)	1.00 (0.039)	3.60 (0.142)	1.00 (0.039)	6.35 (0.250)
2220	6.60 (0.260)	1.00 (0.039)	4.60 (0.181)	1.00 (0.039)	5.00 (0.197)
2225	6.60 (0.260)	1.00 (0.039)	4.60 (0.181)	1.00 (0.039)	6.35 (0.250)

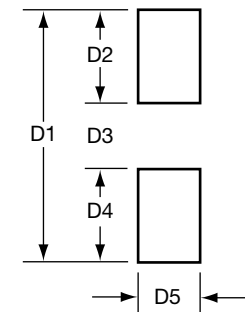

Dimensions in millimeters (inches)

#### Component Pad Design

Component pads should be designed to achieve good solder fillets and minimize component movement during reflow soldering. Pad designs are given below for the most common sizes of multilayer ceramic capacitors for both wave and reflow soldering. The basis of these designs is:

- Pad width equal to component width. It is permissible to decrease this to as low as 85% of component width but it is not advisable to go below this.
- Pad overlap 0.5mm beneath component.
- Pad extension 0.5mm beyond components for reflow and 1.0mm for wave soldering.

### WAVE SOLDERING

Case Size	D1	D2	D3	D4	D5
0603	3.10 (0.12)	1.20 (0.05)	0.70 (0.03)	1.20 (0.05)	0.75 (0.03)
0805	4.00 (0.15)	1.50 (0.06)	1.00 (0.04)	1.50 (0.06)	1.25 (0.05)
1206	5.00 (0.19)	1.50 (0.06)	2.00 (0.09)	1.50 (0.06)	1.60 (0.06)

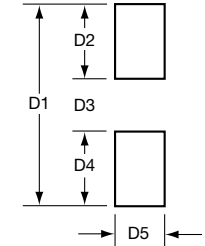

Dimensions in millimeters (inches)

#### Component Spacing

For wave soldering components, must be spaced sufficiently far apart to avoid bridging or shadowing (inability of solder to penetrate properly into small spaces). This is less important for reflow soldering but sufficient space must be allowed to enable rework should it be required.

#### Preheat & Soldering

The rate of preheat should not exceed 4°C/second to prevent thermal shock. A better maximum figure is about 2°C/second.

For capacitors size 1206 and below, with a maximum thickness of 1.25mm, it is generally permissible to allow a temperature differential from preheat to soldering of 150°C. In all other cases this differential should not exceed 100°C.

For further specific application or process advice, please consult AVX.

#### Cleaning

Care should be taken to ensure that the capacitors are thoroughly cleaned of flux residues especially the space beneath the capacitor. Such residues may otherwise become conductive and effectively offer a low resistance bypass to the capacitor.

Ultrasonic cleaning is permissible, the recommended conditions being 8 Watts/litre at 20-45 kHz, with a process cycle of 2 minutes vapor rinse, 2 minutes immersion in the ultrasonic solvent bath and finally 2 minutes vapor rinse.

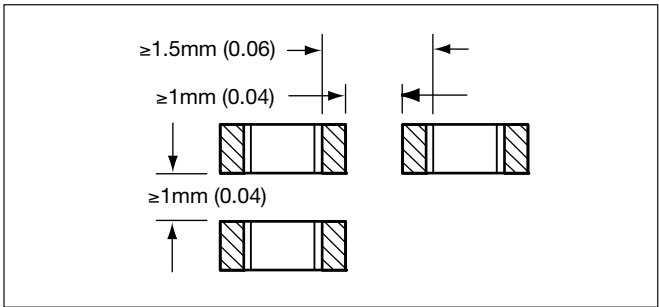



## Recommended Soldering Profiles

### REFLOW SOLDER PROFILES

AVX RoHS compliant products utilize termination finishes (e.g. Sn or SnAg) that are compatible with all Pb-Free soldering systems and are fully reverse compatible with SnPb soldering systems. A recommended SnPb profile is shown for comparison; for Pb-Free soldering, IPC/JEDECJ-STD-020C may be referenced. The upper line in the chart shows the maximum envelope to which products are qualified (typically 3x reflow cycles at 260°C max). The center line gives the recommended profile for optimum wettability and soldering in Pb-Free Systems.

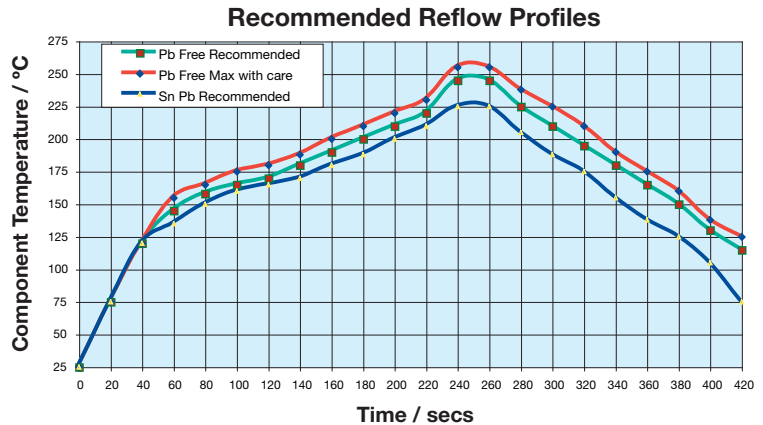

#### Preheat:

The pre-heat stabilizes the part and reduces the temperature differential prior to reflow. The initial ramp to 125°C may be rapid, but from that point (2-3)°C/sec is recommended to allow ceramic parts to heat uniformly and plastic encapsulated parts to stabilize through the glass transition temperature of the body (~ 180°C).

#### Reflow:

In the reflow phase, the maximum recommended time > 230°C is 40secs. Time at peak reflow is 10secs max.; optimum reflow is achieved at 250°C, (see wetting balance chart opposite) but products are qualified to 260°C max. Please reference individual product datasheets for maximum limits

#### Cool Down:

Cool down should not be forced and 6°C/sec is recommended. A slow cool down will result in a finer grain structure of the reflow solder in the solder fillet.

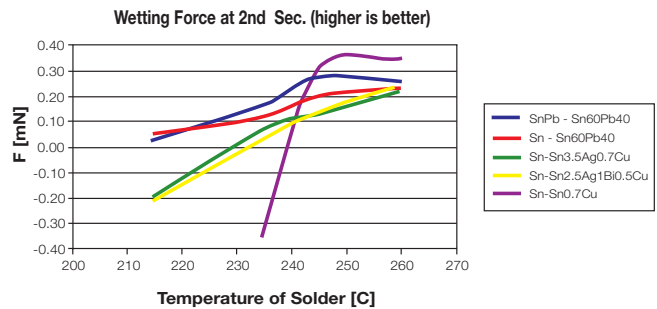

**IMPORTANT NOTE:** Typical Pb-Free reflow solders have a more dull and grainy appearance compared to traditional SnPb. Elevating the reflow temperature will not change this, but extending the cool down can help improve the visual appearance of the joint.

### WAVE SOLDER PROFILES

For wave solder, there is no change in the recommended wave profile; all standard Pb-Free (SnCu/SnCuAg) systems operate at the same 260°C max recommended for SnPb systems.

#### Preheat:

This is more important for wave solder; a higher temperature preheat will reduce the thermal shock to SMD parts that are immersed (please consult individual product data sheets for SMD parts that are suited to wave solder). SMD parts should ideally be heated from the bottom-Side prior to wave. PTH (Pin through hole) parts on the topside should not be separately heated.

#### Wave:

250°C – 260°C recommended for optimum solderability.

#### Cool Down:

As with reflow solder, cool down should not be forced and 6°C/sec is recommended. Any air knives at the end of the 2nd wave should be heated.

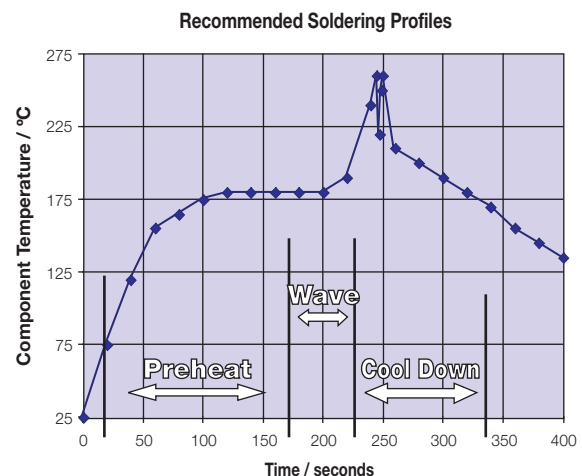

# Surface Mounting Guide

## MLC Chip Capacitors

### APPLICATION NOTES

#### Storage

The components should be stored in their “as received packaging” where possible. If the components are removed from their original packaging then they should be stored in an airtight container (e.g. a heat sealed plastic bag) with desiccant (e.g. silica gel). Storage area temperature should be kept between +5 degrees C and +30 degrees C with humidity < 70% RH. Storage atmosphere must be free of gas containing sulfur and chlorine. Avoid exposing the product to saline moisture or to temperature changes that might result in the formation of condensation. To assure good solderability performance we recommend that the product be used within 6 months from our shipping date, but can be used for up to 12 months. Chip capacitors may crack if exposed to hydrogen (H<sub>2</sub>) gas while sealed or if coated with silicon, which generates hydrogen gas.

#### Solderability

Terminations to be well soldered after immersion in a 60/40 tin/lead solder bath at 235 ± 5°C for 2 ± 1 seconds.

#### Leaching

Terminations will resist leaching for at least the immersion times and conditions shown below.

Termination Type	Solder Tin/Lead/Silver	Solder Temp. °C	Immersion Time Seconds
Nickel Barrier	60/40/0	260 ± 5	30 ± 1

#### Lead-Free Wave Soldering

The recommended peak temperature for lead-free wave soldering is 250°C-260°C for 3-5 seconds. The other parameters of the profile remains the same as above.

The following should be noted by customers changing from lead based systems to the new lead free pastes.

- a) The visual standards used for evaluation of solder joints will need to be modified as lead free joints are not as bright as with tin-lead pastes and the fillet may not be as large.
- b) Lead-free solder pastes do not allow the same self alignment as lead containing systems. Standard mounting pads are acceptable, but machine set up may need to be modified.

#### General

Surface mounting chip multilayer ceramic capacitors are designed for soldering to printed circuit boards or other substrates. The construction of the components is such that they will withstand the time/temperature profiles used in both wave and reflow soldering methods.

#### Handling

Chip multilayer ceramic capacitors should be handled with care to avoid damage or contamination from perspiration and skin oils. The use of tweezers or vacuum pick ups is strongly recommended for individual components. Bulk

handling should ensure that abrasion and mechanical shock are minimized. Taped and reeled components provides the ideal medium for direct presentation to the placement machine. Any mechanical shock should be minimized during handling chip multilayer ceramic capacitors.

#### Preheat

It is important to avoid the possibility of thermal shock during soldering and carefully controlled preheat is therefore required. The rate of preheat should not exceed 4°C/second and a target figure 2°C/second is recommended. Although an 80°C to 120°C temperature differential is preferred, recent developments allow a temperature differential between the component surface and the soldering temperature of 150°C (Maximum) for capacitors of 1210 size and below with a maximum thickness of 1.25mm. The user is cautioned that the risk of thermal shock increases as chip size or temperature differential increases.

#### Soldering

Mildly activated rosin fluxes are preferred. The minimum amount of solder to give a good joint should be used. Excessive solder can lead to damage from the stresses caused by the difference in coefficients of expansion between solder, chip and substrate. AVX terminations are suitable for all wave and reflow soldering systems. If hand soldering cannot be avoided, the preferred technique is the utilization of hot air soldering tools.

#### Cooling

Natural cooling in air is preferred, as this minimizes stresses within the soldered joint. When forced air cooling is used, cooling rate should not exceed 4°C/second. Quenching is not recommended but if used, maximum temperature differentials should be observed according to the preheat conditions above.

#### Cleaning

Flux residues may be hygroscopic or acidic and must be removed. AVX MLC capacitors are acceptable for use with all of the solvents described in the specifications MIL-STD-202 and EIA-RS-198. Alcohol based solvents are acceptable and properly controlled water cleaning systems are also acceptable. Many other solvents have been proven successful, and most solvents that are acceptable to other components on circuit assemblies are equally acceptable for use with ceramic capacitors.

#### Prevention of Metallic Migration

Note that when components with Sn plating on the end terminations are to be used in applications that are likely to experience conditions of high humidity under bias voltage, we strongly recommend that the circuit boards be conformally coated to protect the Sn from moisture that might lead to migration and eventual current leakage.

When using Capacitor Arrays we recommend that there is no differential in applied voltage between adjacent elements.

# Surface Mounting Guide



## MLC Chip Capacitors

### POST SOLDER HANDLING

Once SMP components are soldered to the board, any bending or flexure of the PCB applies stresses to the soldered joints of the components. For leaded devices, the stresses are absorbed by the compliancy of the metal leads and generally don't result in problems unless the stress is large enough to fracture the soldered connection.

Ceramic capacitors are more susceptible to such stress because they don't have compliant leads and are brittle in nature. The most frequent failure mode is low DC resistance or short circuit. The second failure mode is significant loss of capacitance due to severing of contact between sets of the internal electrodes.

Cracks caused by mechanical flexure are very easily identified and generally take one of the following two general forms:

Mechanical cracks are often hidden underneath the termination and are difficult to see externally. However, if one end termination falls off during the removal process from PCB, this is one indication that the cause of failure was excessive mechanical stress due to board warping.



Type A:  
Angled crack between bottom of device to top of solder joint.



Type B:  
Fracture from top of device to bottom of device.

## MLC Chip Capacitors

### COMMON CAUSES OF MECHANICAL CRACKING

The most common source for mechanical stress is board depanelization equipment, such as manual breakapart, v-cutters and shear presses. Improperly aligned or dull cutters may cause torqueing of the PCB resulting in flex stresses being transmitted to components near the board edge. Another common source of flexural stress is contact during parametric testing when test points are probed. If the PCB is allowed to flex during the test cycle, nearby ceramic capacitors may be broken.

A third common source is board to board connections at vertical connectors where cables or other PCBs are connected to the PCB. If the board is not supported during the plug/unplug cycle, it may flex and cause damage to nearby components.

Special care should also be taken when handling large (>6" on a side) PCBs since they more easily flex or warp than smaller boards.

### REWORKING OF MLCS

Thermal shock is common in MLCs that are manually attached or reworked with a soldering iron. *AVX strongly recommends that any reworking of MLCs be done with hot air reflow rather than soldering irons.* It is practically impossible to cause any thermal shock in ceramic capacitors when using hot air reflow.

However direct contact by the soldering iron tip often causes thermal cracks that may fail at a later date. If rework by soldering iron is absolutely necessary, it is recommended that the wattage of the iron be less than 30 watts and the tip temperature be <math><300^{\circ}\text{C}</math>. *Rework should be performed by applying the solder iron tip to the pad and not directly contacting any part of the ceramic capacitor.*

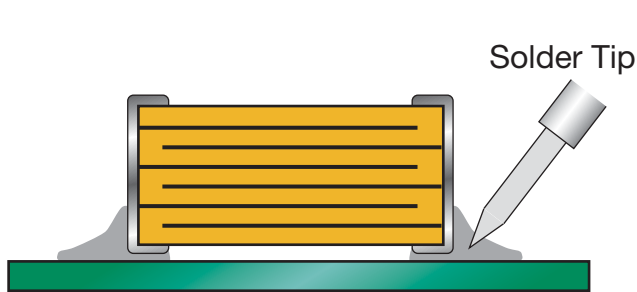

Preferred Method - No Direct Part Contact

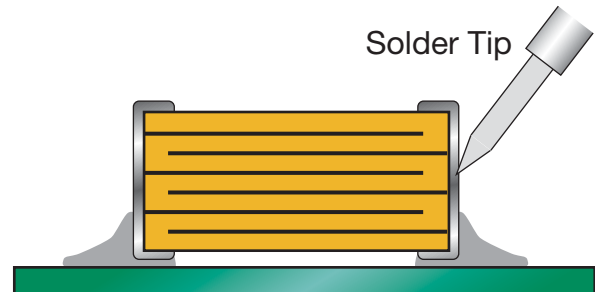

Poor Method - Direct Contact with Part

### PCB BOARD DESIGN

To avoid many of the handling problems, AVX recommends that MLCs be located at least .2" away from nearest edge of board. However when this is not possible, AVX recommends that the panel be routed along the cut line, adjacent to where the MLC is located.

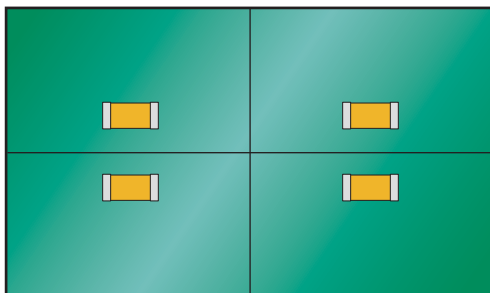

No Stress Relief for MLCs

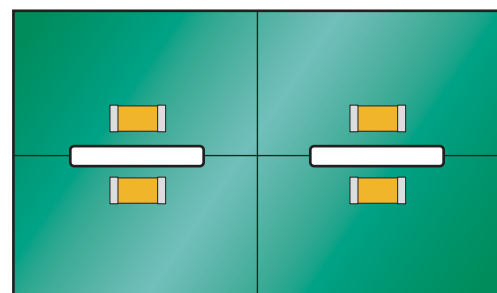

Routed Cut Line Relieves Stress on MLC

## AMERICAS

**AVX Greenville, SC**  
Tel: 864-967-2150

**AVX Northwest, WA**  
Tel: 360-699-8746

**AVX Midwest, IN**  
Tel: 317-861-9184

**AVX Mid/Pacific, CA**  
Tel: 408-988-4900

**AVX Northeast, MA**  
Tel: 617-479-0345

**AVX Southwest, CA**  
Tel: 949-859-9509

**AVX Canada**  
Tel: 905-238-3151

**AVX South America**  
Tel: +55-11-4688-1960

## EUROPE

**AVX Limited, England**  
Tel: +44-1276-697000

**AVX S.A.S., France**  
Tel: +33-1-69-18-46-00

**AVX GmbH, Germany**  
Tel: +49-0811-95949-0

**AVX SRL, Italy**  
Tel: +39-02-614-571

**AVX Czech Republic**  
Tel: +420-57-57-57-521

**AVX/ELCO UK**  
Tel: +44-1638-675000

**ELCO Europe GmbH**  
Tel: +49-2741-299-0

**AVX S.A., Spain**  
Tel: +34-91-63-97-197

**AVX Benelux**  
Tel: +31-187-489-337

## ASIA-PACIFIC

**AVX/Kyocera (S) Pte Ltd.,  
Singapore**  
Tel: +65-6286-7555

**AVX/Kyocera, Asia, Ltd.,  
Hong Kong**  
Tel: +852-2363-3303

**AVX/Kyocera Yuhan Hoesa,  
South Korea**  
Tel: +82-2785-6504

**AVX/Kyocera HK Ltd.,  
Taiwan**  
Tel: +886-2-2656-0258

**AVX/Kyocera (M) Sdn Bhd,  
Malaysia**  
Tel: +60-4228-1190

**AVX/Kyocera International  
Trading Co. Ltd.,  
Shanghai**  
Tel: +86-21-3255 1933

**AVX/Kyocera Asia Ltd.,  
Shenzen**  
Tel: +86-755-3336-0615

**AVX/Kyocera International  
Trading Co. Ltd.,  
Beijing**  
Tel: +86-10-6588-3528

**AVX/Kyocera India  
Liaison Office**  
Tel: +91-80-6450-0715

## ASIA-KED (KYOCERA Electronic Devices)

**KED Hong Kong Ltd.**  
Tel: +852-2305-1080/1223

**KED Hong Kong Ltd.  
Shenzen**  
Tel: +86-755-3398-9600

**KED Company Ltd.  
Shanghai**  
Tel: +86-21-3255-1833

**KED Hong Kong Ltd.  
Beijing**  
Tel: +86-10-5869-4655

**KED Taiwan Ltd.**  
Tel: +886-2-2950-0268

**KED Korea Yuhan Hoesa,  
South Korea**  
Tel: +82-2-783-3604/6126

**KED (S) Pte Ltd.  
Singapore**  
Tel: +65-6509-0328

**Kyocera Corporation  
Japan**  
Tel: +81-75-604-3449

Contact:

