

Reflexus Penta-band SMD Antenna

Part No. A10315

Product Specification

1 Features

- GSM/UMTS antenna supporting up to 5 frequency bands
- Complementary antenna technology provides resistance to de-tuning
- High efficiency
- Easy to integrate
- Intended for SMD mounting
- Supplied in tape on reel

Reflexus supports the following communication standards:

GSM/GPRS/EDGE	CDMA2000 1xRTT/EV-DO/EV-DV	UMTS WCDMA/HSPA	Other Standards
GSM850 (E)GSM900 GSM1800 (DCS) GSM1900 (PCS)	Band Classes: 1,2,3,4,6,8,9,12,14,15	Bands I – VI Bands VIII – X	Korean PCS DECT (outside USA) TD-SCDMA AWS

2 Description

Reflexus uses a ground plane in order to radiate efficiently, but this ground plane must not extend underneath the antenna itself.

The antenna uses a matching circuit to achieve optimized results for the specific frequency bands that are required. This product specification shows the performance of the antenna when optimized to cover a typical penta-band reception: GSM850/900/1800/1900 and WCDMA.

3 Applications

- Mobile handsets
- Femto / Pico base stations
- Tracker devices
- Machine to machine communication
- Remote monitoring



4 Part numbers

A10315



5 General data

Product name	Reflexus GSM SMD
Part Numbers	A10315
Frequency (typical)	824MHz-960MHz 1710MHz -2170MHz
Polarization	Linear
Operating temperature	-40 °C to +85 °C
Impedance with matching	50 Ω
Weight	2.5g
Antenna type	SMD
Dimensions	40 x 10 x 3.2 [mm]

6 Electrical characteristics

	Typical performance	Conditions
Peak gain	2dBi @ 876Mhz 3.7dBi @ 1917Mhz	<p>All data measured on Antenova's reference board, part number A10315-U1M</p> <p>Data given for the 824MHz-960MHz and 1710MHz-2170MHz frequency ranges</p>
Average gain	-1.3dBi 824-960 MHz -1.5dBi 1710-2170 MHz	
Average efficiency 824-960 MHz 1710-2170 MHz	70% >60%	
Maximum Return Loss	-8dB	
Maximum VSWR	2.3:1	

7 Electrical performance

7-1 Return Loss

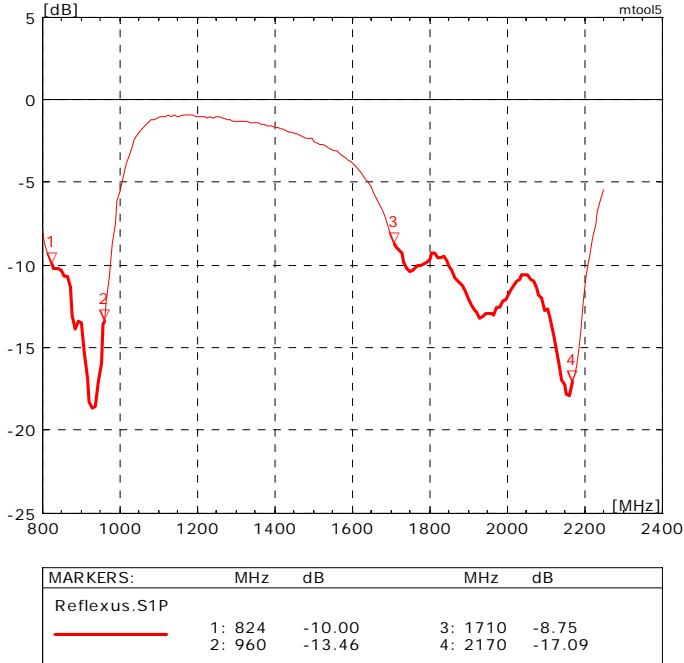

7-2 VSWR

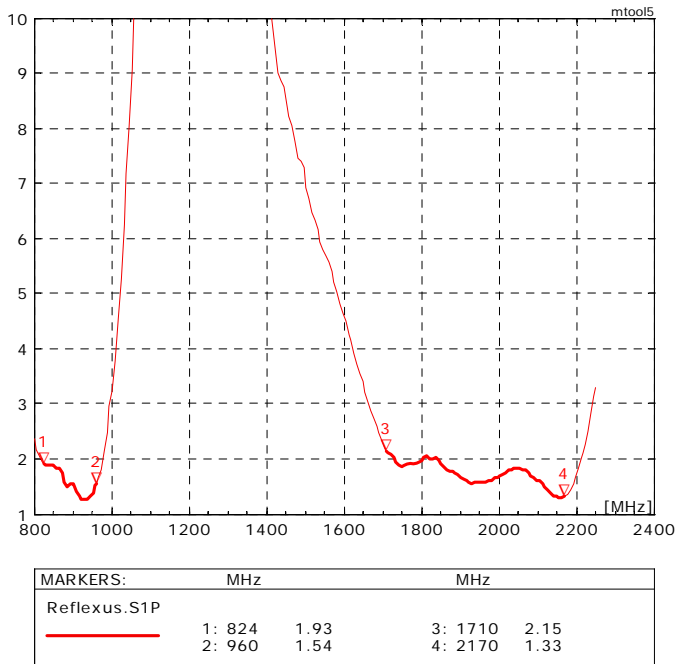

7-3 Antenna patterns 824-960 MHz

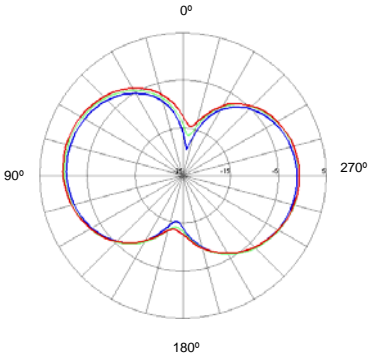
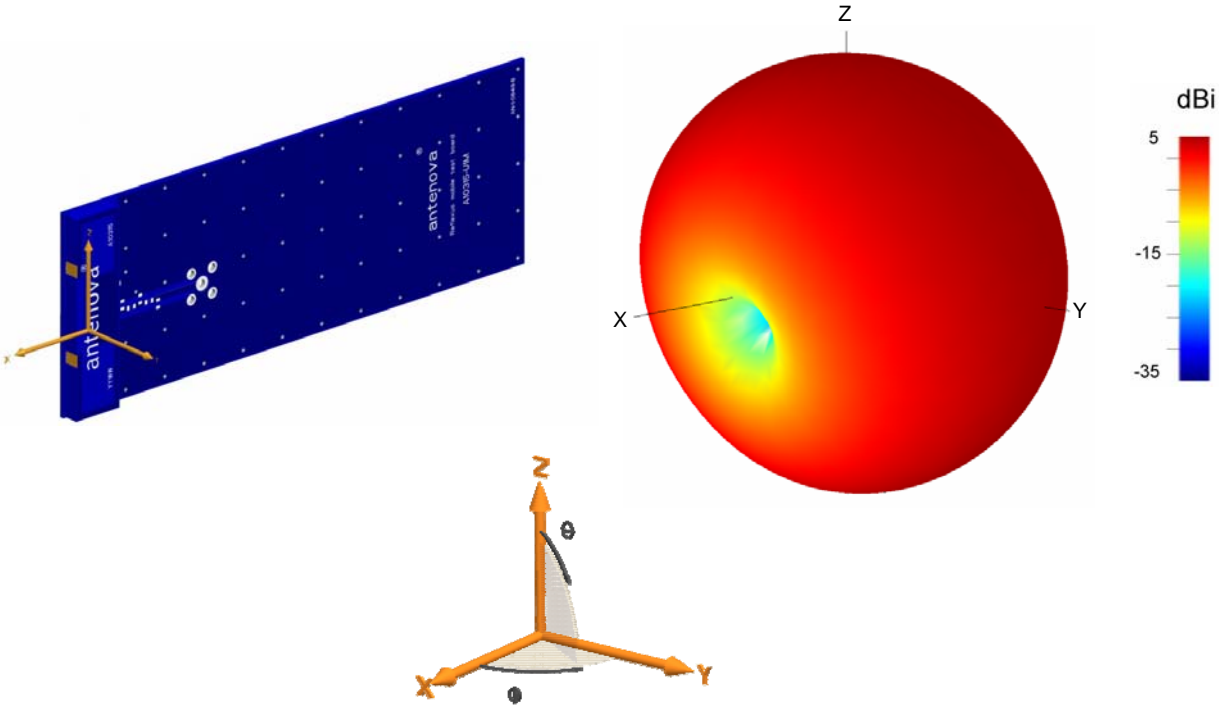

XY plane

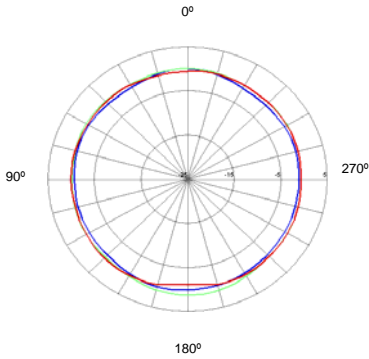

ZY plane

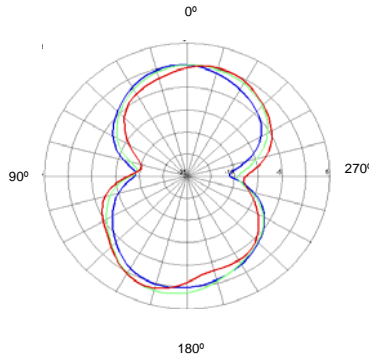

XZ plane

Patterns show combined polarisations measured on reference board A10315-U1M. 3D Pattern measured at 890MHz

7-4 Antenna patterns 1710 – 2170 MHz

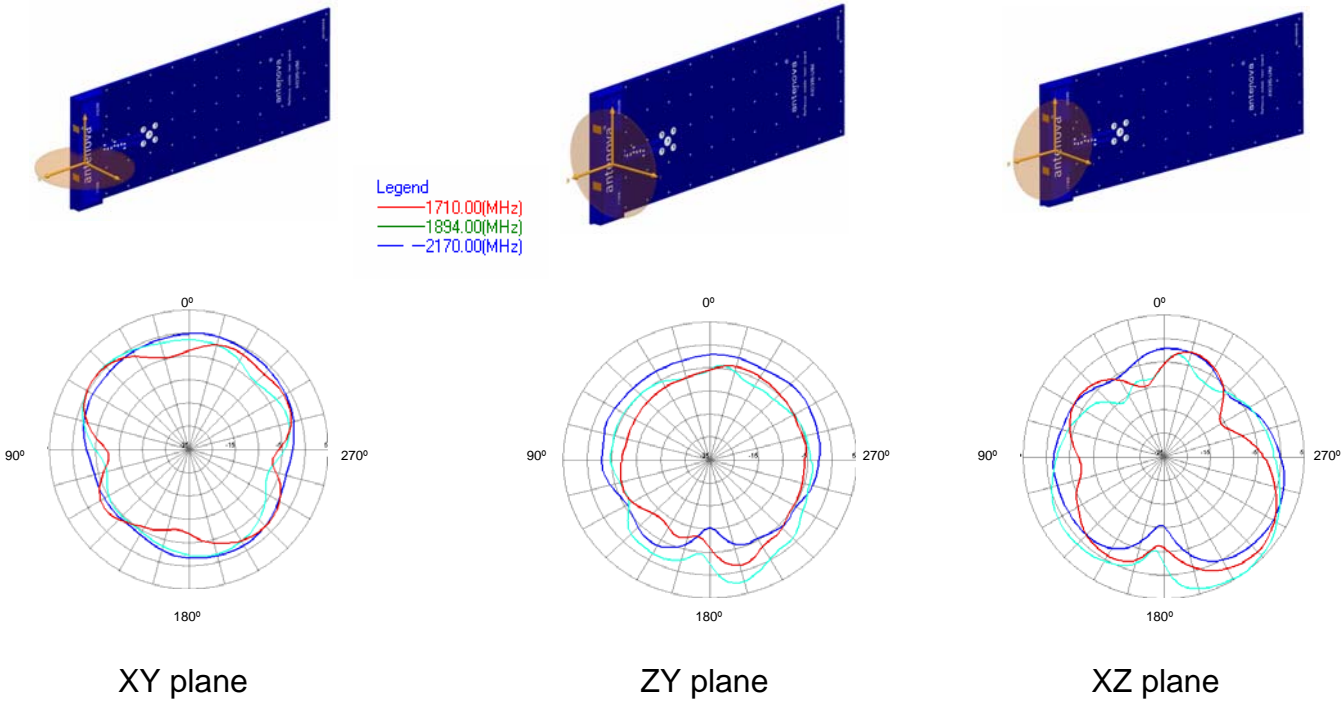
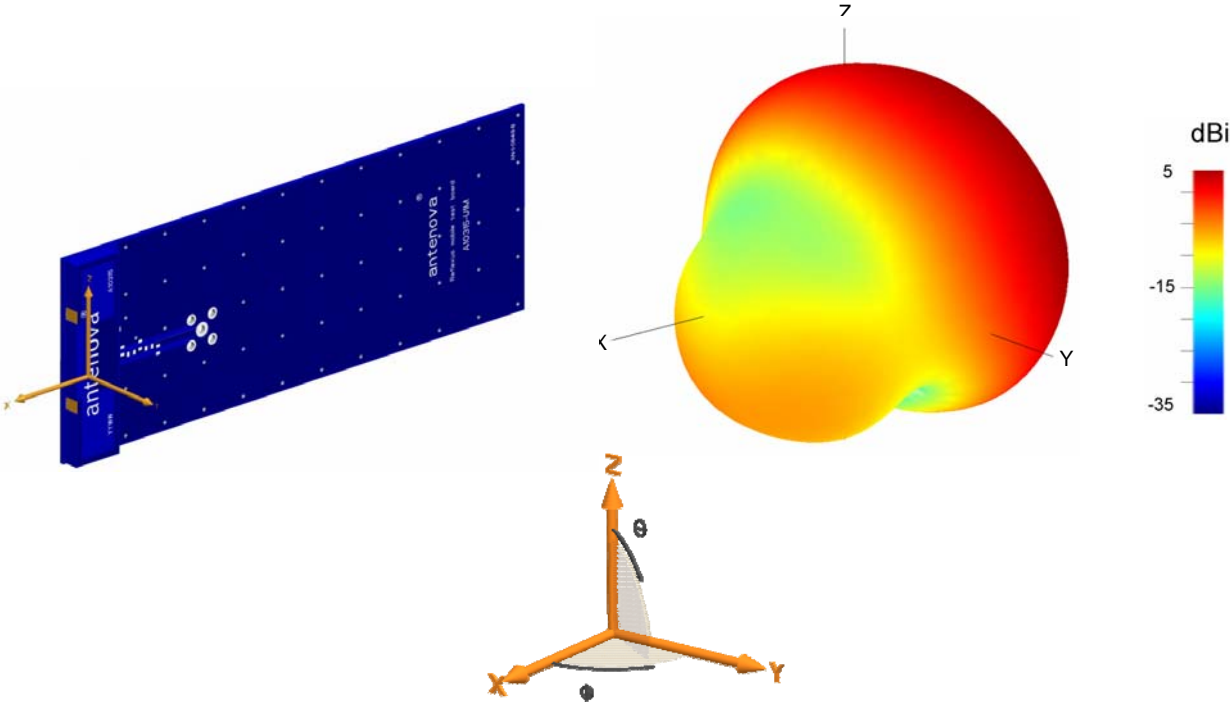

Patterns show combined polarisations measured on reference board A10315-U1M. 3D Pattern measured at 1894MHz

8 Antenna efficiency

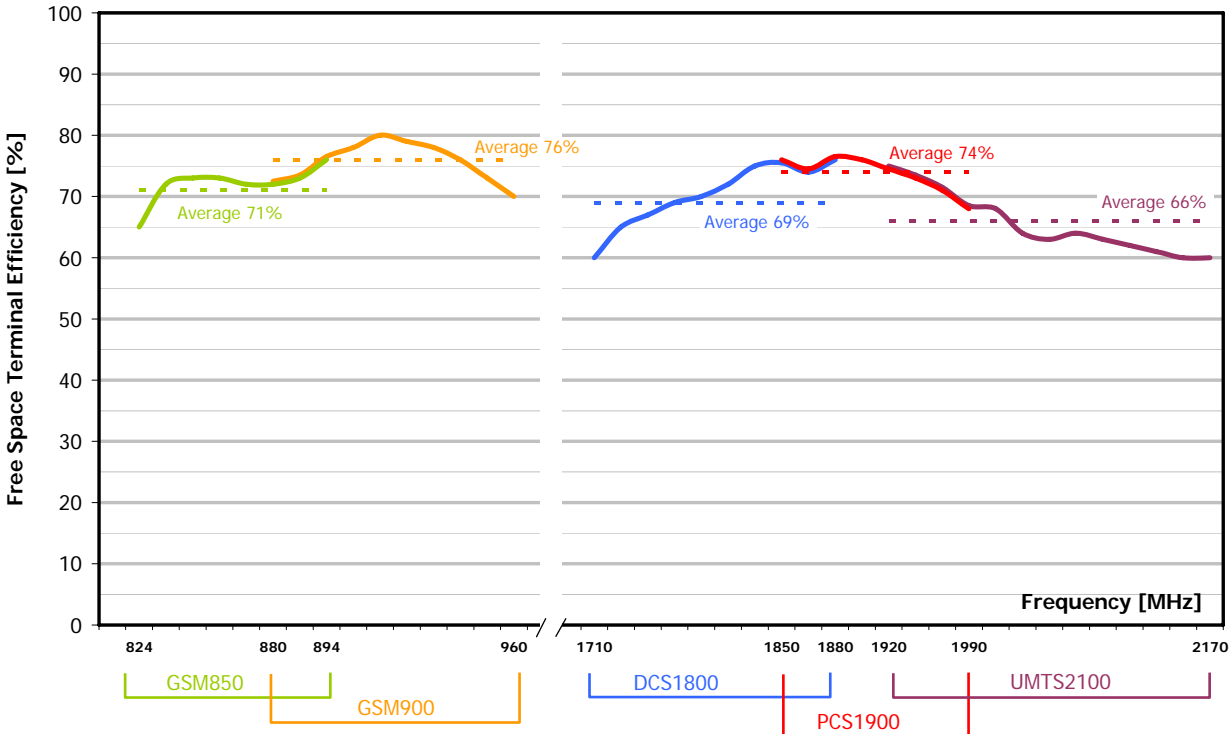

Reflexus efficiency in free space

9 Antenna dimensions

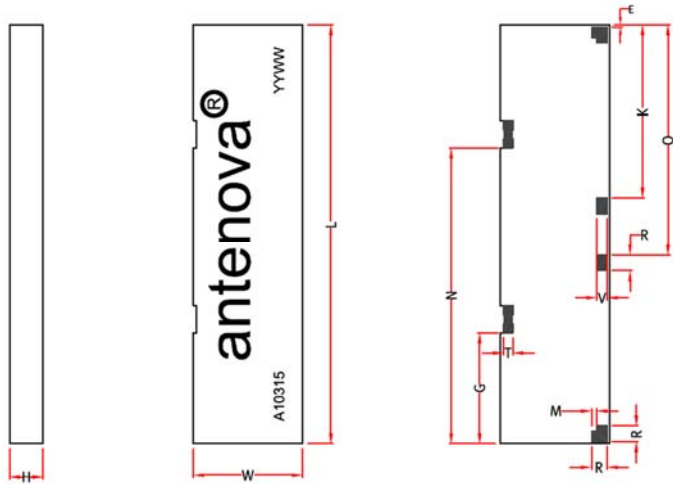

L	W	H	E	N	T	G	R	M	V	O	K
Length	Width	Height									
40.0 +/- 0.2	10.4 +/- 0.2	3.2 +/- 0.15	0.2 +/- 0.15	28.28 +/- 0.15	0.9 +/- 0.15	10.56 +/- 0.15	1.5 +/- 0.15	0.2 +/- 0.15	1.0 +/- 0.15	22 +/- 0.15	16.5 +/- 0.15

Dimensions in mm

Integrated Antenna and RF Solutions

10 Antenna footprint

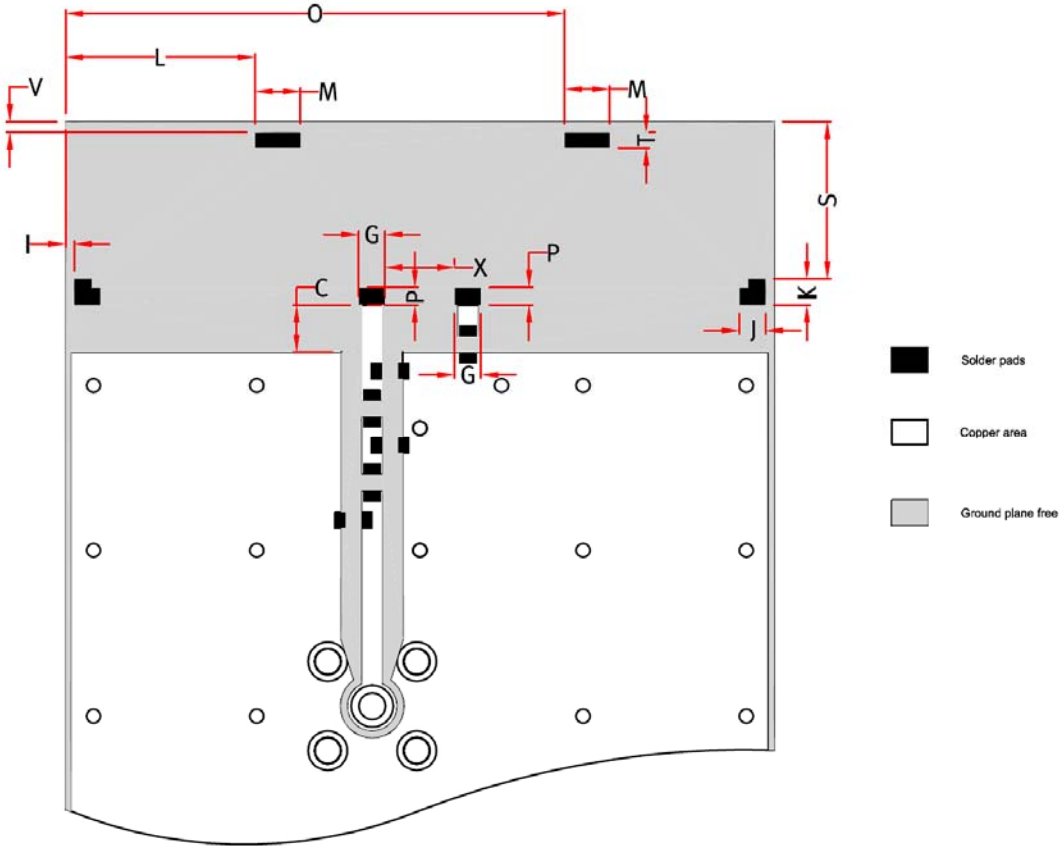

Reflexus GSM (Part No: A10315)

CAD files of the antenna footprint are available from Antenova on request. Please contact info@antenova.com for further details.

X	P	C	G	I	J	K	S	M	O	V	T	L
4.0 +/-0.1	1.0 +/-0.1	2.7 +/-0.1	1.5 +/-0.1	0.5 +/-0.1	1.5 +/-0.1	1.5 +/- 0.1	9.0 +/-0.1	2.6 +/-0.1	28.58 +/-0.1	0.6 +/- 0.1	0.9 +/- 0.1	10.86 +/- 0.1

11 Electrical interface

11-1 Transmission lines

The antenna should be connected using an RF transmission line.

All transmission lines should be designed to have a characteristic impedance of 50Ω . The length of the transmission lines should be kept to a minimum. Any other parts of the RF system like transceivers, power amplifiers, etc, should also be designed to have an impedance of 50Ω .

Once the material for the PCB has been chosen (PCB thickness and dielectric constant), a co-planar transmission line can easily be designed using any of the commercial software packages for transmission line design. For the chosen PCB thickness, copper thickness and substrate dielectric constant, the program will calculate the appropriate transmission line width and gaps on either side of the track so the characteristic impedance of the co-planar transmission line is 50Ω .

11-2 Matching circuit

The antenna requires a matching circuit that must be optimized for each customer's product. The matching circuit will require up to five components depending on the impedance of the antenna when situated in the device, and pads have been designed for 0603 components for best results. In addition to the matching circuit, a separate DC blocking capacitor will also be required between the radio and the antenna matching circuit.

The following pad layout should be designed into the device so the correct circuit can be installed:

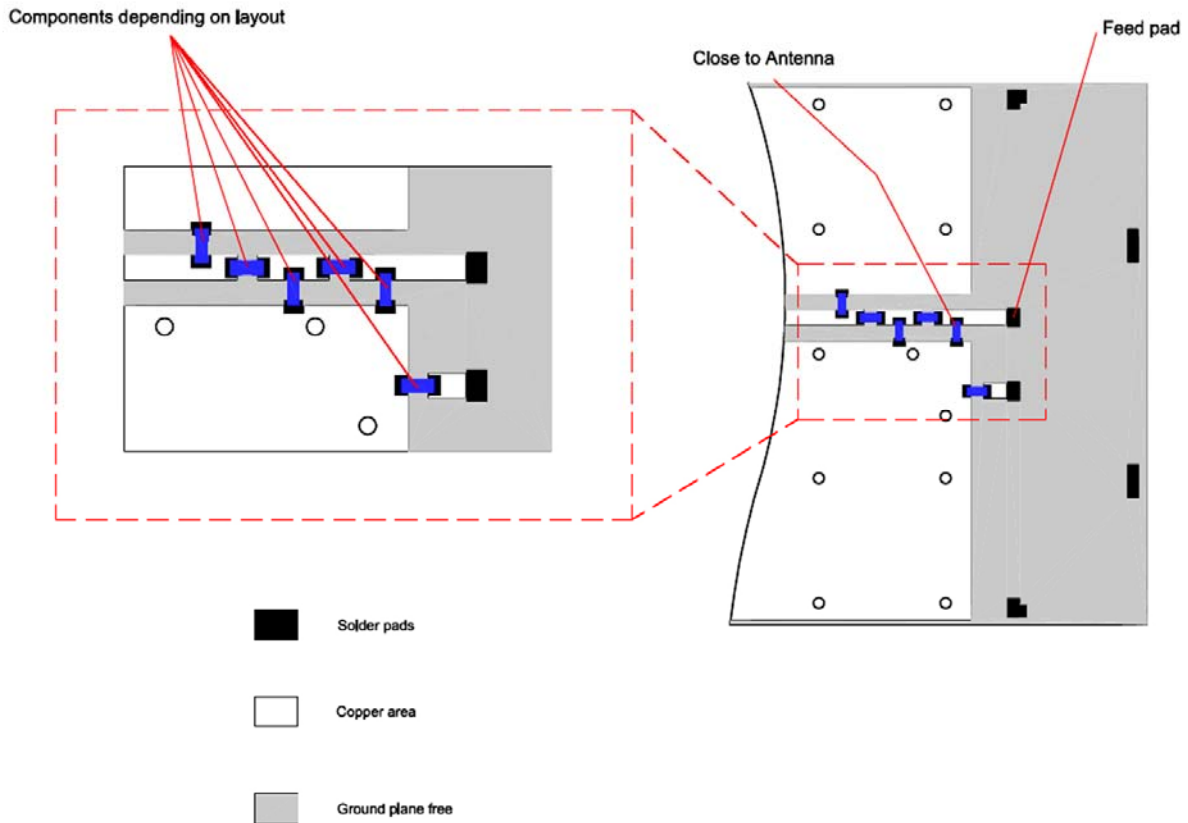

Note: The component values for the matching circuit will vary depending on the size of the PCB and surrounding components. The impedance of the antenna should be measured before selecting suitable matching components. Antenova offers a matching service on request. Contact info@antenova.com for further information.

11-3 Antenna placement

Reflexus should be fitted to the device so that power from the antenna can radiate into free space. Antenova strongly recommends placing the antenna near the edge of the board. Maximum antenna performance is achieved by placing the antenna close to the corner of the PCB with few components or metal objects nearby. Ground can be placed at the side of the antenna, but the remaining space around the antenna, including directly above and below should be free from components or conducting objects. The placements shown here are for guidance only, as the actual performance differences will depend on each individual device.

Antenova offers a full range of development support to ensure efficient implementation of the antenna into the specific design. To overcome RF design issues, matching circuits, transmission lines, layout and other components, please contact Antenova (info@antenova.com) for design and placement recommendations.

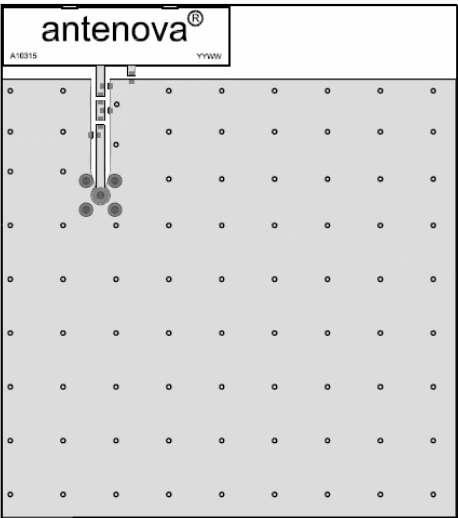

Best Performance

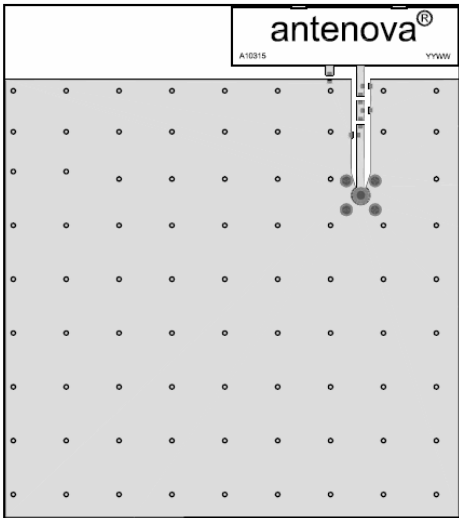

Best Performance

11-4 Reference board

The reference board has been designed for evaluation purposes of Reflexus GSM antenna and it includes a SMA female connector. The reference board is available with Reflexus tuned to cover 5 bands: GSM850/900/1800/1900 and WCDMA, Part number: A10315-U1M

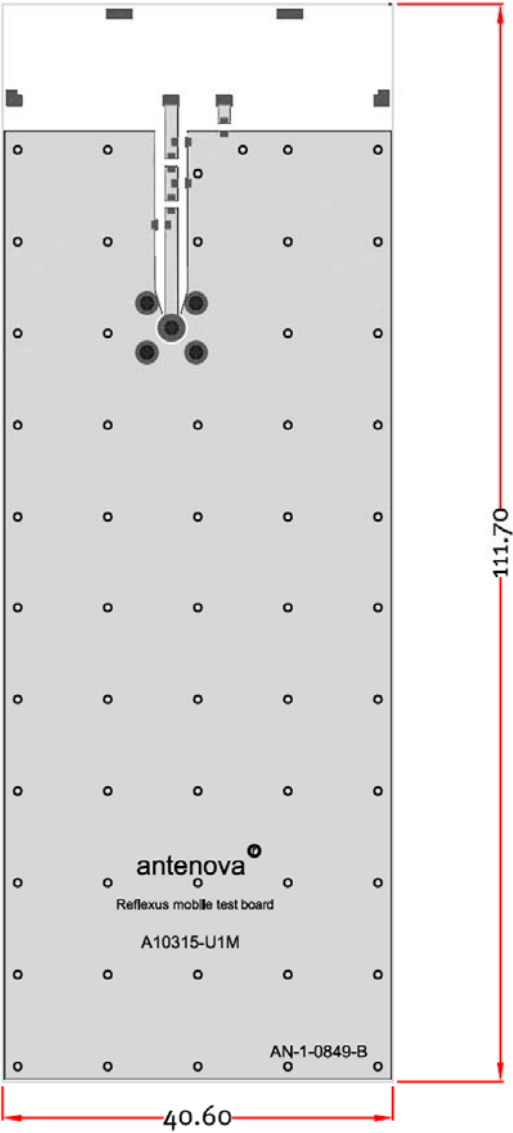

Dimensions in mm

Note: Other size reference boards are available for typical applications. Contact info@antenna.com for further information or to order a reference board.

12 Soldering

This antenna is suitable for lead free soldering.

The reflow profile should be adjusted to suit the PCBA, oven and solder paste, while observing the following conditions:

- The maximum temperature should not exceed 240 °C
- However for lead free soldering, a maximum temperature of 255 °C for no more than 20 seconds is permitted.
- The antenna should not be exposed to temperatures exceeding 120 °C more than 3 times during the soldering process.

13 Hazardous material regulation conformance

The antenna has been tested to conform to RoHS requirements. A certificate of conformance is available from Antenova's website.

14 Packaging

14-1 Optimal storage conditions for packaged reels

Temperature	-10°C to 40°C
Humidity	Less than 75% RH
Shelf Life	18 Months
Storage place	Away from corrosive gas and direct sunlight
Packaging	Reels should be stored in unopened sealed manufacturer's plastic packaging.

Note: Storage of open reels of antennas is not recommended due to possible oxidization of pads on antennas. If short term storage is necessary, then it is highly recommended that the bag containing the antenna reel is re-sealed and stored in like storage conditions as in above table.

14-2 Tape characteristics

Reflexus

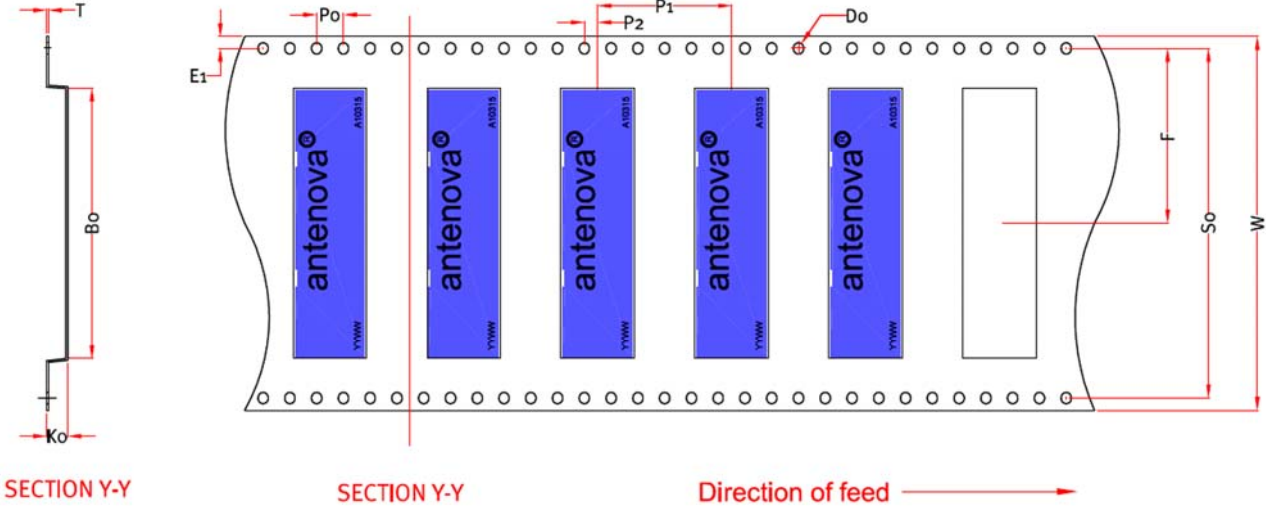

W	F	E1	P0	P1	P2	A0	B0	K0	SO	T	D0
56 ± 0.2	26.2 ± 0.1	1.75 ± 0.1	4 ± 0.1	20 ± 0.1	2 ± 0.1	9.3 ± 0.1	40.6 ± 0.1	1.3 ± 0.1	52.4 ± 0.1	0.3 ± 0.05	Min 1.5 +/- 0.1

Dimensions in mm

Quantity	Leading Space	Trailing Space
1000 pcs / reel	50 blank antenna holders	50 blank antenna holders

14-3 Reel dimensions

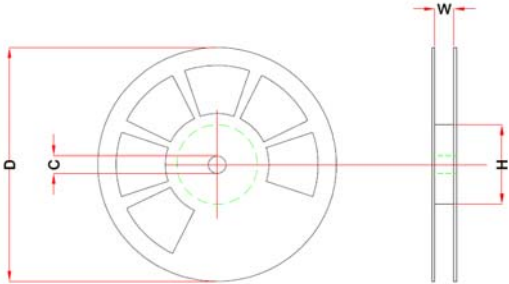

Width	Reel Diameter	Hub Diameter	Shaft Diameter
70 mm	330 +/- 2.0 mm	80 mm	13 +/- 0.5 mm

14-4 Box dimensions



Width W	Breadth B	Thickness H
195 mm	195 mm	37 mm

14-5 Bag properties

Reels are supplied in protective plastic packaging

14-6 Box label information

Reflexus



Dimensions in mm



www.antenova.com

Corporate Headquarters

Antenova Ltd.
Far Field House
Albert Road
Stow-cum-Quy
Cambridge
CB25 9AR
UK

Tel: +44 1223 810600
Fax: +44 1223 810650
Email: info@antenova.com

North America Headquarters

Antenova Ltd.
Rogers Business Park
2541 Technology Drive Suite 403
Elgin, IL 60124
USA

Tel: +1 (847) 551 9710
Fax: +1 (847) 551 9719
Email: info@antenova.com

Asia Headquarters

Antenova Asia Ltd.
4F, No. 324, Sec. 1, Nei-Hu Road
Nei-Hu District
Taipei 11493
Taiwan, ROC

Tel: +886 (0) 2 8797 8630
Fax: +886 (0) 2 8797 6890
Email: info@antenova.com

Copyright® 2009 Antenova Ltd. All Rights Reserved. Antenova® and gigaNOVA® are trademarks of Antenova Ltd. Any other names and/or trademarks belong to their respective companies.

The materials provided herein are believed to be reliable and correct at the time of print. Antenova does not warrant the accuracy or completeness of the information, text, graphics or other items contained within these information. Antenova further assumes no responsibility for the use of this information, and all such information shall be entirely at the user's risk.



Certificate No: 4598

Integrated Antenna and RF Solutions