

# Micropower Precision Shunt Voltage Reference

## FEATURES

- Initial Voltage Accuracy: 0.05%
- Low Operating Current: 10 $\mu$ A
- Low Drift: 10ppm/ $^{\circ}$ C Max
- Less Than 1 $\Omega$  Dynamic Impedance
- Both Commercial and Industrial Temperature Range Parts Are Available
- Available in 1.25V, 2.5V, 4.096V and 5V in SO-8 and TO-92 Packages
- 1.25V and 2.5V Available in MSOP Package

## APPLICATIONS

- Portable Meters
- Precision Regulators
- A/D and D/A Converters
- Calibrators

## DESCRIPTION

The LT<sup>®</sup>1634 is a micropower, precision, shunt voltage reference. The bandgap reference uses trimmed precision thin film resistors to achieve 0.05% initial voltage accuracy. Improved curvature correction technique guarantees 10ppm/ $^{\circ}$ C maximum temperature drift. Advances in design, processing and packaging techniques guarantee 10 $\mu$ A operation and low temperature cycling hysteresis. The LT1634 does not require an output compensation capacitor, but is stable with capacitive loads. Low dynamic impedance makes the LT1634 reference easy to use from unregulated supplies.

The LT1634 reference can be used as a high performance upgrade to the LM185/LM385, LT1004 and LT1034 where lower power and guaranteed temperature drift is required.

LT, LTC and LTM are registered trademarks of Linear Technology Corporation. All other trademarks are the property of their respective owners.

## TYPICAL APPLICATION

Super Accurate  $\pm 4.096$ V Output References

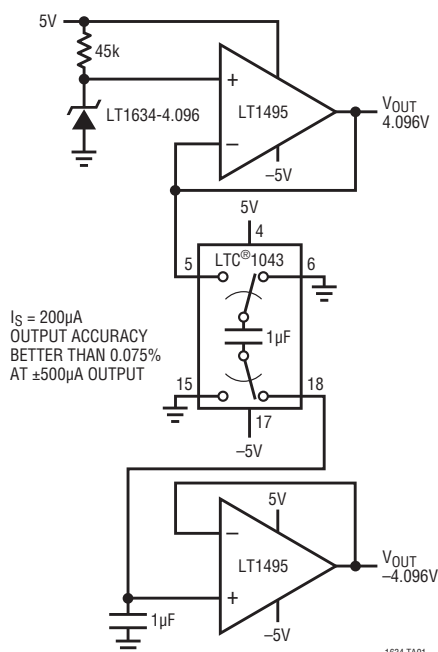

Temperature Drift

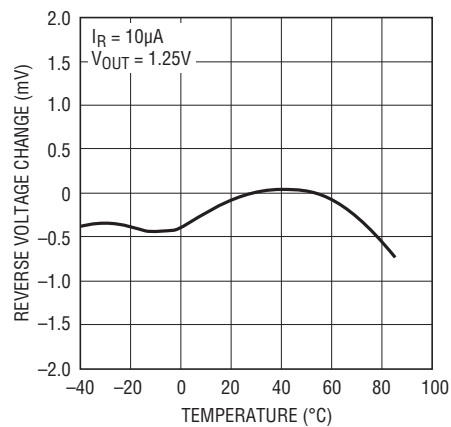

# LT1634

## ABSOLUTE MAXIMUM RATINGS (Note 1)

### Current Operating

|                      |       |
|----------------------|-------|
| 1.25V .....          | 100mA |
| 2.5V .....           | 50mA  |
| 4.096V, 5V .....     | 30mA  |
| Forward Current..... | 20mA  |

### Operating Temperature Range

|   |                |
|---|----------------|
| Commercial .....                          | 0°C to 70°C    |
| Industrial .....                          | -40°C to 85°C  |
| Storage Temperature Range (Note 1).....   | -65°C to 150°C |
| Lead Temperature (Soldering, 10 sec)..... | 300°C          |

## PIN CONFIGURATION

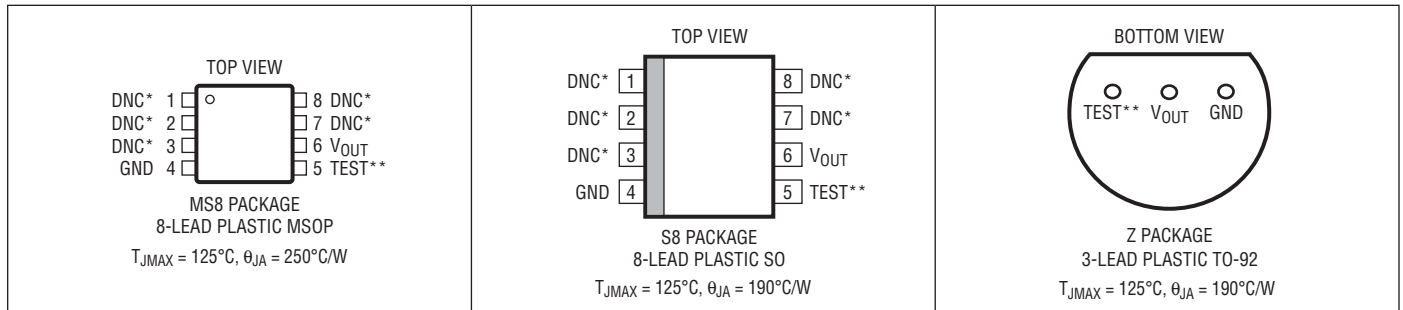

\*Connected internally. Do Not Connect external circuitry to these pins.

\*\*The TEST pin can be left unconnected or connected to the GND pin (GND pin on Z package, Pin4 on MS8 and S8 packages)

## ORDER INFORMATION

| LEAD FREE FINISH     | TAPE AND REEL          | PART MARKING | PACKAGE DESCRIPTION  | SPECIFIED TEMPERATURE RANGE |
|----------------------|------------------------|--------------|----------------------|-----------------------------|
| LT1634BCMS8-1.25#PBF | LT1634BCMS8-1.25#TRPBF | LTCV         | 8-Lead Plastic MSOP  | 0°C to 70°C                 |
| LT1634BCMS8-2.5#PBF  | LT1634BCMS8-2.5#TRPBF  | LTDF         | 8-Lead Plastic MSOP  | 0°C to 70°C                 |
| LT1634ACS8-1.25#PBF  | LT1634ACS8-1.25#TRPBF  | 1634A1       | 8-Lead Plastic SO    | 0°C to 70°C                 |
| LT1634ACS8-2.5#PBF   | LT1634ACS8-2.5#TRPBF   | 1634A2       | 8-Lead Plastic SO    | 0°C to 70°C                 |
| LT1634ACS8-4.096#PBF | LT1634ACS8-4.096#TRPBF | 1634A4       | 8-Lead Plastic SO    | 0°C to 70°C                 |
| LT1634ACS8-5#PBF     | LT1634ACS8-5#TRPBF     | 1634A5       | 8-Lead Plastic SO    | 0°C to 70°C                 |
| LT1634AIS8-1.25#PBF  | LT1634AIS8-1.25#TRPBF  | 634AI1       | 8-Lead Plastic SO    | -40°C to 85°C               |
| LT1634AIS8-2.5#PBF   | LT1634AIS8-2.5#TRPBF   | 634AI2       | 8-Lead Plastic SO    | -40°C to 85°C               |
| LT1634AIS8-4.096#PBF | LT1634AIS8-4.096#TRPBF | 634AI4       | 8-Lead Plastic SO    | -40°C to 85°C               |
| LT1634AIS8-5#PBF     | LT1634AIS8-5#TRPBF     | 634AI5       | 8-Lead Plastic SO    | -40°C to 85°C               |
| LT1634BCS8-1.25#PBF  | LT1634BCS8-1.25#TRPBF  | 1634B1       | 8-Lead Plastic SO    | 0°C to 70°C                 |
| LT1634BCS8-2.5#PBF   | LT1634BCS8-2.5#TRPBF   | 1634B2       | 8-Lead Plastic SO    | 0°C to 70°C                 |
| LT1634BCS8-4.096#PBF | LT1634BCS8-4.096#TRPBF | 1634B4       | 8-Lead Plastic SO    | 0°C to 70°C                 |
| LT1634BCS8-5#PBF     | LT1634BCS8-5#TRPBF     | 1634B5       | 8-Lead Plastic SO    | 0°C to 70°C                 |
| LT1634BIS8-1.25#PBF  | LT1634BIS8-1.25#TRPBF  | 634BI1       | 8-Lead Plastic SO    | -40°C to 85°C               |
| LT1634BIS8-2.5#PBF   | LT1634BIS8-2.5#TRPBF   | 634BI2       | 8-Lead Plastic SO    | -40°C to 85°C               |
| LT1634BIS8-4.096#PBF | LT1634BIS8-4.096#TRPBF | 634BI4       | 8-Lead Plastic SO    | -40°C to 85°C               |
| LT1634BIS8-5#PBF     | LT1634BIS8-5#TRPBF     | 634BI5       | 8-Lead Plastic SO    | -40°C to 85°C               |
| LT1634CCZ-1.25#PBF   | LT1634CCZ-1.25#TRPBF   |              | 3-Lead Plastic TO-92 | 0°C to 70°C                 |
| LT1634CCZ-2.5#PBF    | LT1634CCZ-2.5#TRPBF    |              | 3-Lead Plastic TO-92 | 0°C to 70°C                 |
| LT1634CCZ-4.096#PBF  | LT1634CCZ-4.096#TRPBF  |              | 3-Lead Plastic TO-92 | 0°C to 70°C                 |
| LT1634CCZ-5#PBF      | LT1634CCZ-5#TRPBF      |              | 3-Lead Plastic TO-92 | 0°C to 70°C                 |

Consult LTC Marketing for parts specified with wider operating temperature ranges.

Consult LTC Marketing for information on lead based finish parts.

For more information on lead free part marking, go to: <http://www.linear.com/leadfree/>

For more information on tape and reel specifications, go to: <http://www.linear.com/tapeandree/>

1634fe

## AVAILABLE OPTIONS

| TEMPERATURE   | ACCURACY (%) | TEMPERATURE COEFFICIENT<br>(ppm/°C) | PACKAGE TYPE                        |   |   |
|---------------|--------------|-------------------------------------|-------------------------------------|---|---|
|               |              |                                     | MS8                                 | S8  | Z   |
| 0°C to 70°C   | 0.05         | 10                                  |                                     | LT1634ACS8-1.25<br>LT1634ACS8-2.5<br>LT1634ACS8-4.096<br>LT1634ACS8-5 |   |
| -40°C to 85°C | 0.05         | 10                                  |                                     | LT1634AIS8-1.25<br>LT1634AIS8-2.5<br>LT1634AIS8-4.096<br>LT1634AIS8-5 |   |
| 0°C to 70°C   | 0.05         | 25                                  | LT1634BCMS8-1.25<br>LT1634BCMS8-2.5 | LT1634BCS8-1.25<br>LT1634BCS8-2.5<br>LT1634BCS8-4.096<br>LT1634BCS8-5 |   |
| -40°C to 85°C | 0.05         | 25                                  |                                     | LT1634BIS8-1.25<br>LT1634BIS8-2.5<br>LT1634BIS8-4.096<br>LT1634BIS8-5 |   |
| 0°C to 70°C   | 0.20         | 25                                  |                                     |   | LT1634CCZ-1.25<br>LT1634CCZ-2.5<br>LT1634CCZ-4.096<br>LT1634CCZ-5 |

## 1.25V ELECTRICAL CHARACTERISTICS

The ● denotes the specifications which apply over the full operating temperature range, otherwise specifications are at T<sub>A</sub> = 25°C. (Note 3)

| PARAMETER   | CONDITIONS  | MIN               | TYP          | MAX              | UNITS             |
|---|---|-------------------|--------------|------------------|-------------------|
| Reverse Breakdown Voltage                         | LT1634ACS8/LT1634BCMS8/LT1634BCS8/<br>LT1634AIS8/LT1634BIS8 (I <sub>R</sub> = 10μA) | 1.24937<br>-0.05  | 1.250        | 1.25062<br>0.05  | V<br>%            |
|   | LT1634CCZ (I <sub>R</sub> = 10μA)   | 1.24750<br>-0.20  | 1.250        | 1.25250<br>0.20  | V<br>%            |
|   | LT1634ACS8 (I <sub>R</sub> = 10μA) ●  | 1.24849<br>-0.12  | 1.250        | 1.25149<br>0.12  | V<br>%            |
|   | LT1634AIS8 (I <sub>R</sub> = 10μA) ●  | 1.24781<br>-0.175 | 1.250        | 1.25218<br>0.175 | V<br>%            |
|   | LT1634BCS8/LT1634BCMS8 (I <sub>R</sub> = 10μA) ●                                    | 1.24718<br>-0.225 | 1.250        | 1.25281<br>0.225 | V<br>%            |
|   | LT1634BIS8 (I <sub>R</sub> = 10μA) ●  | 1.24547<br>-0.362 | 1.250        | 1.25453<br>0.362 | V<br>%            |
|   | LT1634CCZ (I <sub>R</sub> = 10μA) ●   | 1.24531<br>-0.375 | 1.250        | 1.25469<br>0.375 | V<br>%            |
| Reverse Breakdown Change<br>with Current (Note 4) | 10μA ≤ I <sub>R</sub> ≤ 2mA ●   |                   | 0.25<br>0.30 | 1<br>2           | mV<br>mV          |
|   | 2mA ≤ I <sub>R</sub> ≤ 20mA ●   |                   | 2<br>2       | 8<br>10          | mV<br>mV          |
| Minimum Operating Current                         |   |                   |              | 7                | μA                |
| Temperature Coefficient (Note 8)                  | LT1634A, I <sub>R</sub> = 10μA ●  |                   | 4            | 10               | ppm/°C            |
|   | LT1634B/LT1634C, I <sub>R</sub> = 10μA ●  |                   | 10           | 25               | ppm/°C            |
| Reverse Dynamic Impedance (Note 5)                | 10μA ≤ I <sub>R</sub> ≤ 2mA ●   |                   | 0.125        | 0.5              | Ω                 |
|   |   |                   | 0.150        | 1.0              | Ω                 |
| Low Frequency Noise (Note 6)                      | I <sub>R</sub> = 10μA, 0.1Hz ≤ f ≤ 10Hz   |                   | 10           |                  | μV <sub>P-P</sub> |
| Hysteresis (Note 7)                               | ΔT = -40°C to 85°C  |                   | 160          |                  | ppm               |
|   | ΔT = 0°C to 70°C  |                   | 40           |                  | ppm               |

## 2.5V ELECTRICAL CHARACTERISTICS

The ● denotes the specifications which apply over the full operating temperature range, otherwise specifications are at  $T_A = 25^\circ\text{C}$ . (Note 3)

| PARAMETER                                      | CONDITIONS  | MIN                 | TYP          | MAX              | UNITS                      |
|--|---|---------------------|--------------|------------------|----------------------------|
| Reverse Breakdown Voltage                      | LT1634ACS8/LT1634BCMS8/LT1634BCS8/<br>LT1634AIS8/LT1634BIS8 ( $I_R = 10\mu\text{A}$ ) | 2.49875<br>-0.05    | 2.500        | 2.50125<br>0.05  | V<br>%                     |
|  | LT1634CCZ ( $I_R = 10\mu\text{A}$ )   | 2.49500<br>-0.20    | 2.500        | 2.50500<br>0.20  | V<br>%                     |
|  | LT1634ACS8 ( $I_R = 10\mu\text{A}$ )  | ● 2.49700<br>-0.12  | 2.500        | 2.50300<br>0.12  | V<br>%                     |
|  | LT1634AIS8 ( $I_R = 10\mu\text{A}$ )  | ● 2.49562<br>-0.175 | 2.500        | 2.50437<br>0.175 | V<br>%                     |
|  | LT1634BCMS8/LT1634BCS8 ( $I_R = 10\mu\text{A}$ )                                      | ● 2.49437<br>-0.225 | 2.500        | 2.50562<br>0.225 | V<br>%                     |
|  | LT1634BIS8 ( $I_R = 10\mu\text{A}$ )  | ● 2.49094<br>-0.362 | 2.500        | 2.50906<br>0.362 | V<br>%                     |
|  | LT1634CCZ ( $I_R = 10\mu\text{A}$ )   | ● 2.49062<br>-0.375 | 2.500        | 2.50937<br>0.375 | V<br>%                     |
| Reverse Breakdown Change with Current (Note 4) | $10\mu\text{A} \leq I_R \leq 2\text{mA}$  | ●                   | 0.30<br>0.40 | 1.5<br>3.0       | mV<br>mV                   |
|  | $2\text{mA} \leq I_R \leq 20\text{mA}$  | ●                   | 2<br>2       | 8<br>10          | mV<br>mV                   |
| Minimum Operating Current                      |   | ●                   |              | 8                | $\mu\text{A}$              |
| Temperature Coefficient (Note 8)               | LT1634A, $I_R = 10\mu\text{A}$  | ●                   | 4            | 10               | ppm/ $^\circ\text{C}$      |
|  | LT1634B/LT1634C, $I_R = 10\mu\text{A}$  | ●                   | 10           | 25               | ppm/ $^\circ\text{C}$      |
| Reverse Dynamic Impedance (Note 5)             | $10\mu\text{A} \leq I_R \leq 2\text{mA}$  | ●                   | 0.15<br>0.20 | 0.75<br>1.50     | $\Omega$<br>$\Omega$       |
|  |   |                     |              |                  |                            |
| Low Frequency Noise (Note 6)                   | $I_R = 10\mu\text{A}$ , $0.1\text{Hz} \leq f \leq 10\text{Hz}$                        |                     | 15           |                  | $\mu\text{V}_{\text{P-P}}$ |
| Hysteresis (Note 7)                            | $\Delta T = -40^\circ\text{C}$ to $85^\circ\text{C}$                                  |                     | 160          |                  | ppm                        |
|  | $\Delta T = 0^\circ\text{C}$ to $70^\circ\text{C}$                                    |                     | 40           |                  | ppm                        |

## 4.096 ELECTRICAL CHARACTERISTICS

The ● denotes the specifications which apply over the full operating temperature range, otherwise specifications are at  $T_A = 25^\circ\text{C}$ . (Note 3)

| PARAMETER                                      | CONDITIONS  | MIN                 | TYP          | MAX              | UNITS         |
|--|---|---------------------|--------------|------------------|---------------|
| Reverse Breakdown Voltage                      | LT1634ACS8/LT1634BCS8/<br>LT1634AIS8/LT1634BIS8 ( $I_R = 20\mu\text{A}$ ) | 4.09395<br>-0.05    | 4.096        | 4.09805<br>0.05  | V<br>%        |
|  | LT1634CCZ ( $I_R = 20\mu\text{A}$ )                                       | 4.08780<br>-0.20    | 4.096        | 4.10419<br>0.20  | V<br>%        |
|  | LT1634ACS8 ( $I_R = 20\mu\text{A}$ )                                      | ● 4.09108<br>-0.12  | 4.096        | 4.10091<br>0.12  | V<br>%        |
|  | LT1634AIS8 ( $I_R = 20\mu\text{A}$ )                                      | ● 4.08883<br>-0.175 | 4.096        | 4.10317<br>0.175 | V<br>%        |
|  | LT1634BCS8 ( $I_R = 20\mu\text{A}$ )                                      | ● 4.08678<br>-0.225 | 4.096        | 4.10522<br>0.225 | V<br>%        |
|  | LT1634BIS8 ( $I_R = 20\mu\text{A}$ )                                      | ● 4.08115<br>-0.362 | 4.096        | 4.11085<br>0.362 | V<br>%        |
|  | LT1634CCZ ( $I_R = 20\mu\text{A}$ )                                       | ● 4.08064<br>-0.375 | 4.096        | 4.11137<br>0.375 | V<br>%        |
| Reverse Breakdown Change with Current (Note 4) | $20\mu\text{A} \leq I_R \leq 2\text{mA}$                                  | ●                   | 0.30<br>0.40 | 1.5<br>3.0       | mV<br>mV      |
|  | $2\text{mA} \leq I_R \leq 20\text{mA}$                                    | ●                   | 6<br>6       | 15<br>20         | mV<br>mV      |
| Minimum Operating Current                      |   | ●                   |              | 15               | $\mu\text{A}$ |

**4.096V ELECTRICAL CHARACTERISTICS** The ● denotes the specifications which apply over the full operating temperature range, otherwise specifications are at T<sub>A</sub> = 25°C. (Note 3)

| PARAMETER                          | CONDITIONS                              | MIN | TYP  | MAX  | UNITS             |
|------------------------------------|---|-----|------|------|-------------------|
| Temperature Coefficient (Note 8)   | LT1634A, I <sub>R</sub> = 20μA          | ●   | 4    | 10   | ppm/°C            |
|                                    | LT1634B/LT1634C, I <sub>R</sub> = 20μA  | ●   | 10   | 25   | ppm/°C            |
| Reverse Dynamic Impedance (Note 5) | 20μA ≤ I <sub>R</sub> ≤ 2mA             | ●   | 0.15 | 0.75 | Ω                 |
|                                    |   |     | 0.20 | 1.50 |                   |
| Low Frequency Noise (Note 6)       | I <sub>R</sub> = 20μA, 0.1Hz ≤ f ≤ 10Hz |     | 30   |      | μV <sub>P-P</sub> |
| Hysteresis (Note 7)                | ΔT = -40°C to 85°C<br>ΔT = 0°C to 70°C  |     | 160  |      | ppm               |
|                                    |   |     | 40   |      |                   |

**5V ELECTRICAL CHARACTERISTICS** The ● denotes the specifications which apply over the full operating temperature range, otherwise specifications are at T<sub>A</sub> = 25°C. (Note 3)

| PARAMETER                                      | CONDITIONS  | MIN    | TYP     | MAX   | UNITS             |   |
|--|---|--------|---------|-------|-------------------|---|
| Reverse Breakdown Voltage                      | LT1634ACS8/LT1634BCS8/<br>LT1634AIS8/LT1634BIS8 (I <sub>R</sub> = 20μA) |        | 4.99750 | 5.000 | 5.00250           | V |
|  |   |        | -0.05   |       | 0.05              | % |
|  | LT1634CCZ (I <sub>R</sub> = 20μA)                                       |        | 4.99000 | 5.000 | 5.01000           | V |
|  |   |        | -0.20   |       | 0.20              | % |
|  | LT1634ACS8 (I <sub>R</sub> = 20μA)                                      | ●      | 4.99400 | 5.000 | 5.00600           | V |
|  |   |        | -0.12   |       | 0.12              | % |
|  | LT1634AIS8 (I <sub>R</sub> = 20μA)                                      | ●      | 4.99125 | 5.000 | 5.00875           | V |
|  |   | -0.175 |         | 0.175 | %                 |   |
| Reverse Breakdown Change with Current (Note 4) | 20μA ≤ I <sub>R</sub> ≤ 2mA   | ●      | 0.30    | 1.5   | mV                |   |
|  |   |        | 0.40    | 3.0   |                   |   |
| Minimum Operating Current                      | 2mA ≤ I <sub>R</sub> ≤ 20mA   | ●      | 6       | 15    | mV                |   |
|  |   |        | 6       | 20    |                   |   |
| Reverse Breakdown Change with Current (Note 4) | 2mA ≤ I <sub>R</sub> ≤ 20mA   | ●      |         | 15    | μA                |   |
| Temperature Coefficient (Note 8)               | LT1634A, I <sub>R</sub> = 20μA  | ●      | 4       | 10    | ppm/°C            |   |
|  | LT1634B/LT1634C, I <sub>R</sub> = 20μA                                  | ●      | 10      | 25    | ppm/°C            |   |
| Reverse Dynamic Impedance (Note 5)             | 20μA ≤ I <sub>R</sub> ≤ 2mA   | ●      | 0.15    | 0.75  | Ω                 |   |
|  |   |        | 0.20    | 1.50  |                   |   |
| Low Frequency Noise (Note 6)                   | I <sub>R</sub> = 20μA, 0.1Hz ≤ f ≤ 10Hz                                 |        | 35      |       | μV <sub>P-P</sub> |   |
| Hysteresis (Note 7)                            | ΔT = -40°C to 85°C<br>ΔT = 0°C to 70°C                                  |        | 160     |       | ppm               |   |
|  |   |        | 40      |       |                   |   |

**Note 1:** Stresses beyond those listed under Absolute Maximum Ratings may cause permanent damage to the device. Exposure to any Absolute Maximum Rating condition for extended periods may affect device reliability and lifetime.

**Note 2:** If the part is stored outside of the specific operating temperature range, the output may shift due to hysteresis.

**Note 3:** ESD (Electrostatic Discharge) sensitive device. Use proper ESD handling precautions.

**Note 4:** Output requires 0.1μF for operating current greater than 1mA.

**Note 5:** This parameter is guaranteed by “reverse breakdown change with current” test.

**Note 6:** Peak-to-peak noise is measured with a single highpass filter at 0.1Hz and 2-pole lowpass filter at 10Hz.

**Note 7:** Hysteresis in output voltage is created by package stress that differs depending on whether the IC was previously at a higher or lower temperature. Output voltage is always measured at 25°C but the IC is cycled to 85°C or -40°C before successive measurements. Hysteresis is roughly proportional to the square of the temperature change. Hysteresis is not normally a problem for operational temperature excursions where the instrument might be stored at high or low temperature.

**Note 8:** Temperature coefficient is calculated from the minimum and maximum output voltage measured at T<sub>MIN</sub>, Room and T<sub>MAX</sub> as follows:

$$TC = (V_{OMAX} - V_{OMIN}) / (T_{MAX} - T_{MIN})$$

Incremental slope is also measured at 25°C.

# 1.25V TYPICAL PERFORMANCE CHARACTERISTICS

**Reverse Characteristics**

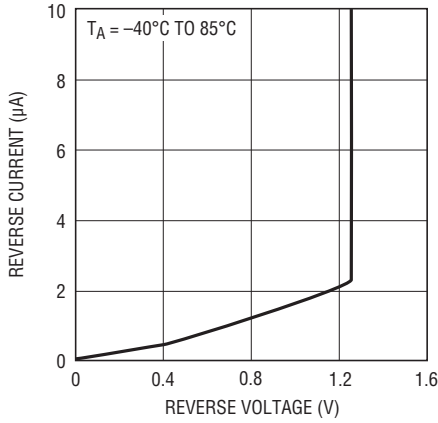

1634-1.25 G01

**Temperature Drift**

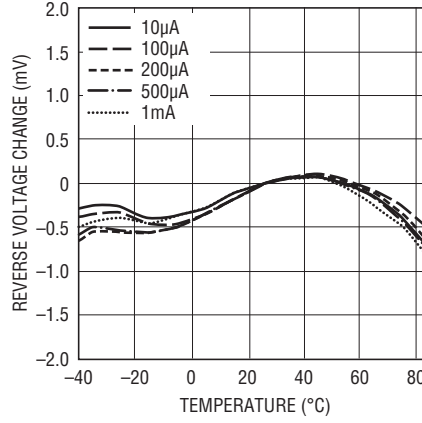

1634-1.25 G02

**Reverse Voltage Change vs Current**

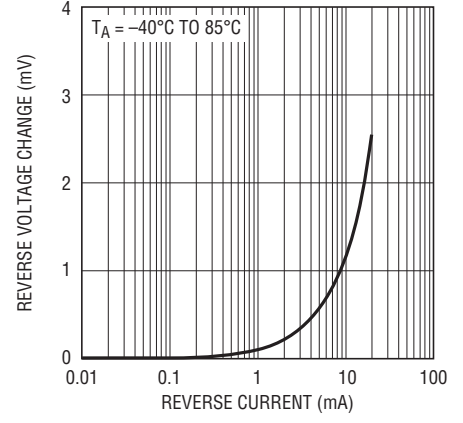

1634-1.25 G03

**Reverse Dynamic Impedance**

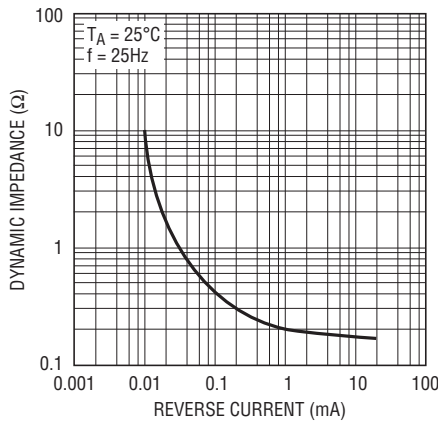

1634-1.25 G04

**Dynamic Impedance vs Frequency**

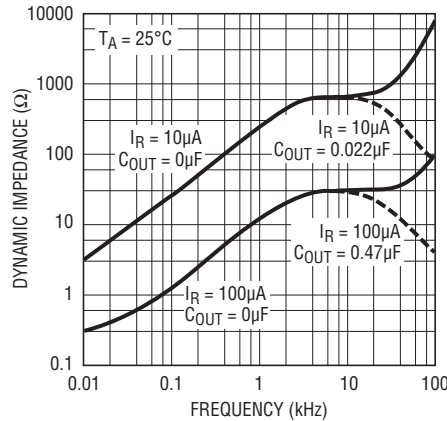

1634-1.25 G05

**Forward Characteristics**

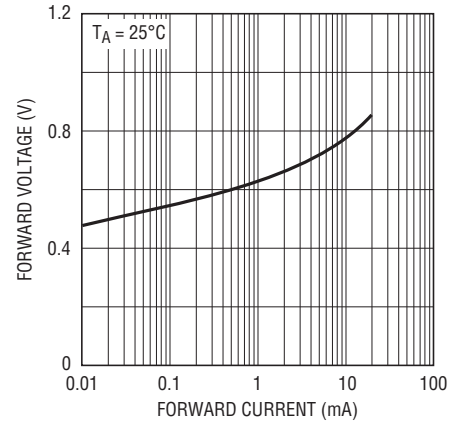

1634-1.25 G06

**0.1Hz to 10Hz Noise**

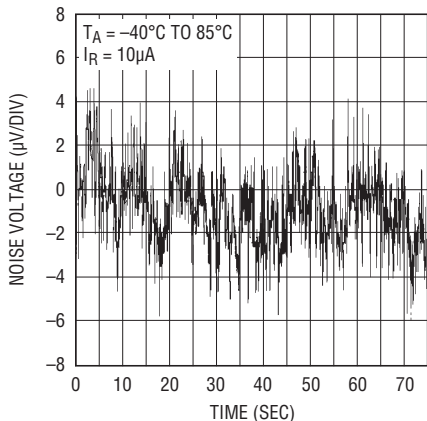

1634-1.25 G07

**Response Time**

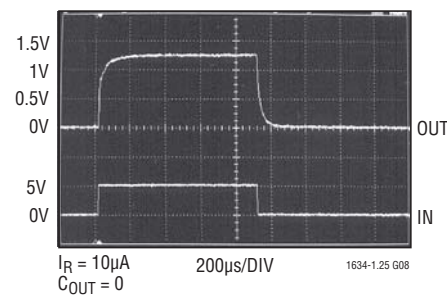

1634-1.25 G08

**Response Time**

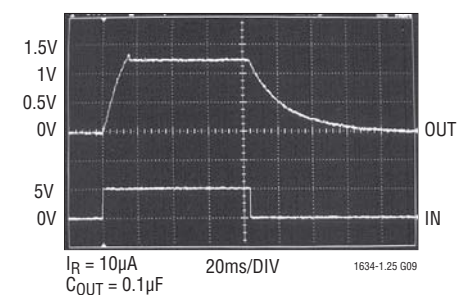

1634-1.25 G09

## 2.5V TYPICAL PERFORMANCE CHARACTERISTICS

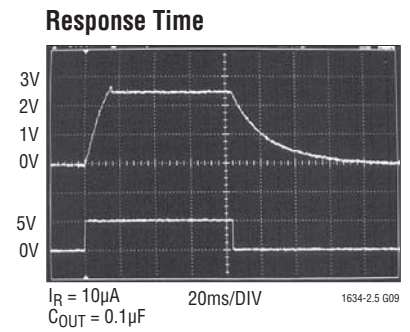
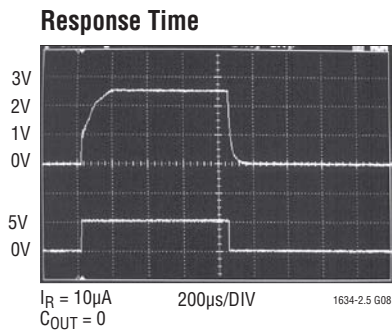
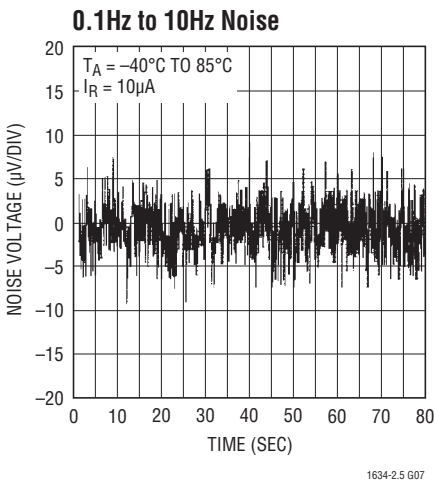
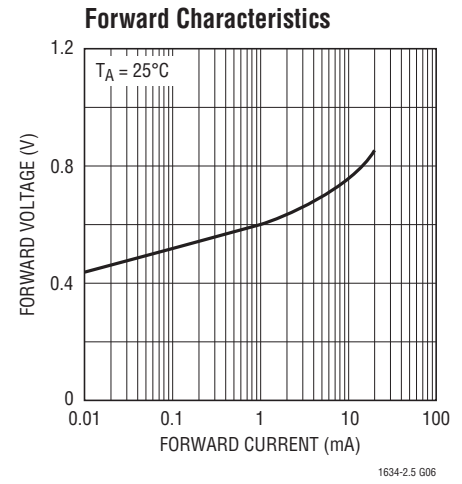
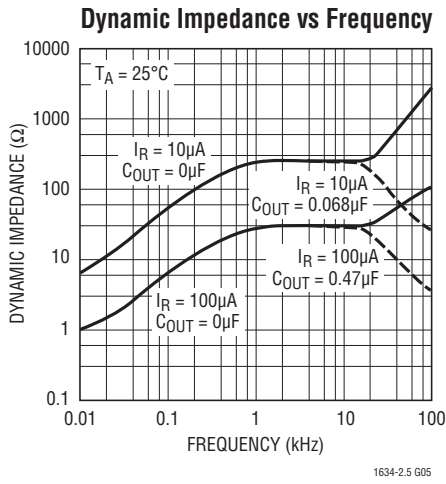
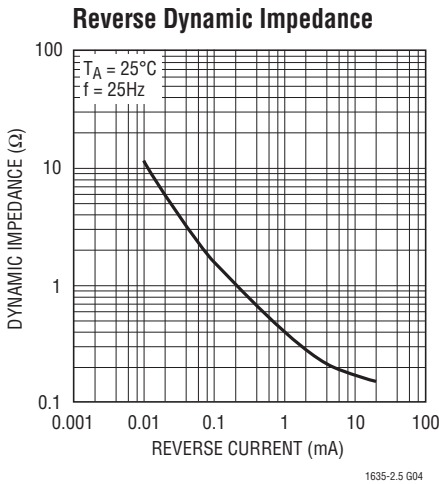
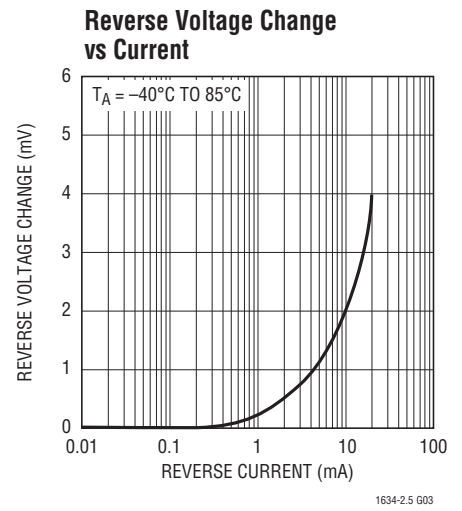
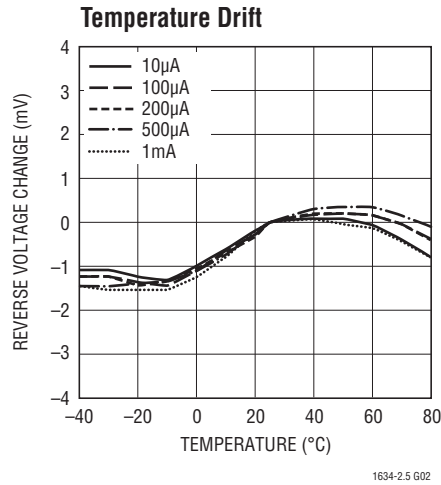
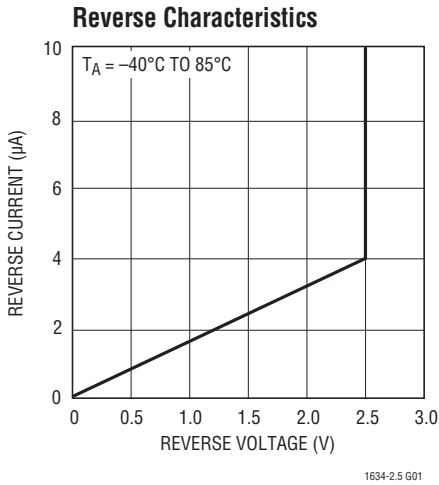



# 4.096V TYPICAL PERFORMANCE CHARACTERISTICS

**Reverse Characteristics**

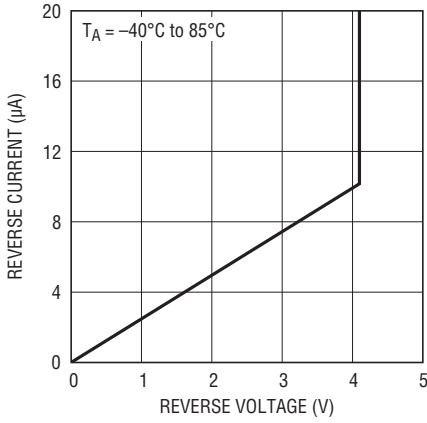

1634-4 G01

**Temperature Drift**

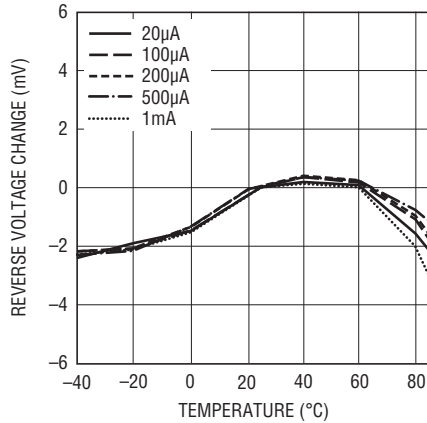

1634-4 G02

**Reverse Voltage Change vs Current**

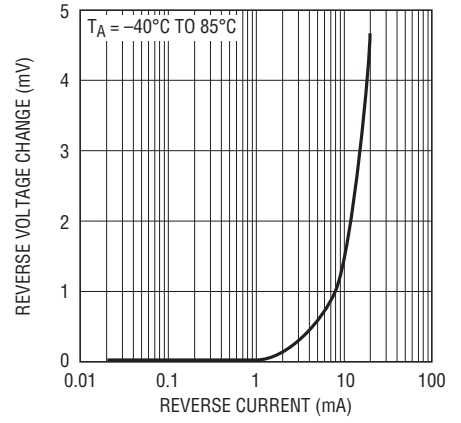

1634-4 G03

**Reverse Dynamic Impedance**

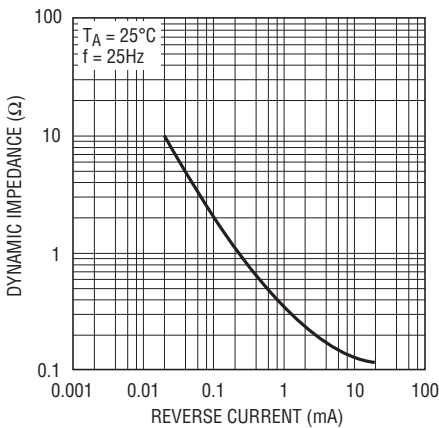

1635-4 G04

**Dynamic Impedance vs Frequency**

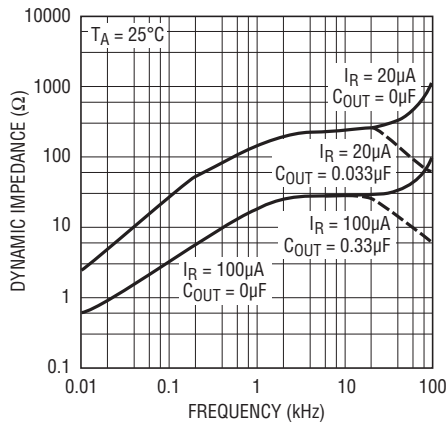

1634-4 G05

**Forward Characteristics**

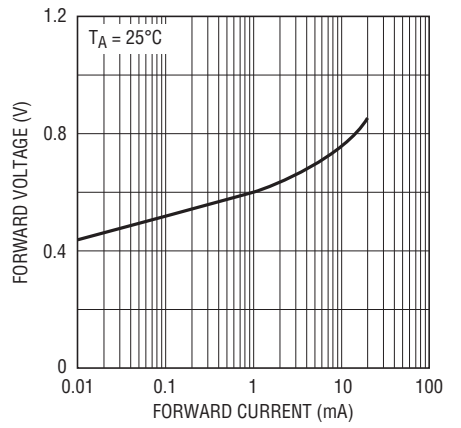

1634-2.5 G06

**0.1Hz to 10Hz Noise**

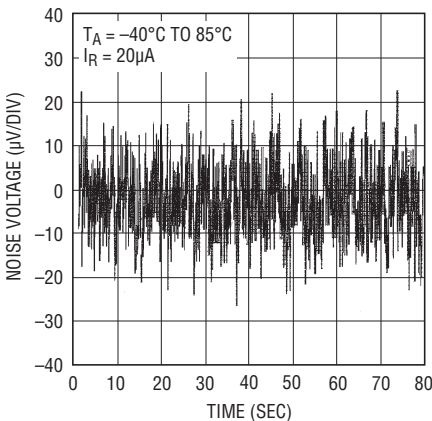

1634-4 G06

**Response Time**

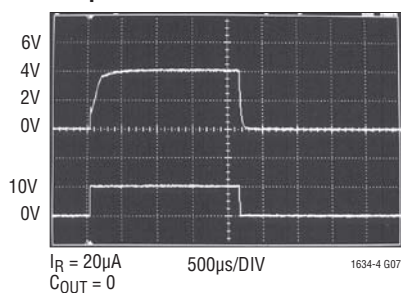

1634-4 G07

**Response Time**

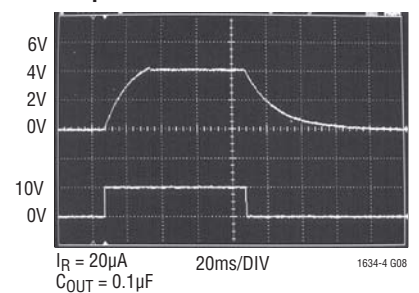

1634-4 G08



# 5V TYPICAL PERFORMANCE CHARACTERISTICS

**Reverse Characteristics**

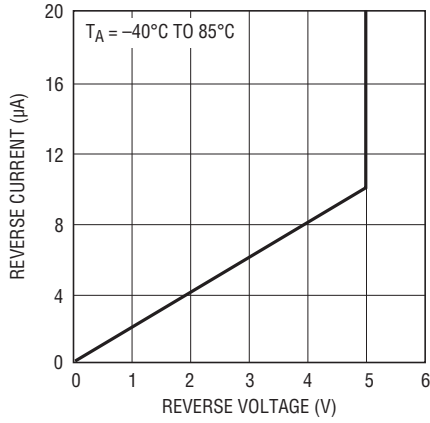

1634-5 G01

**Temperature Drift**

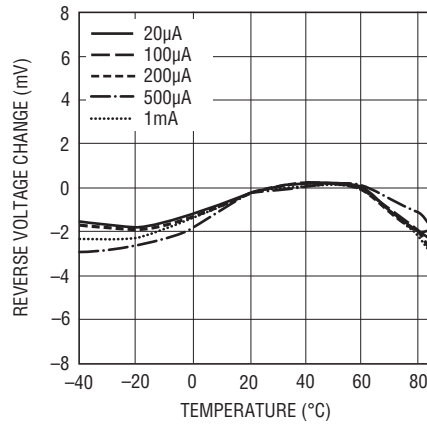

1634-5 G02

**Reverse Voltage Change vs Current**

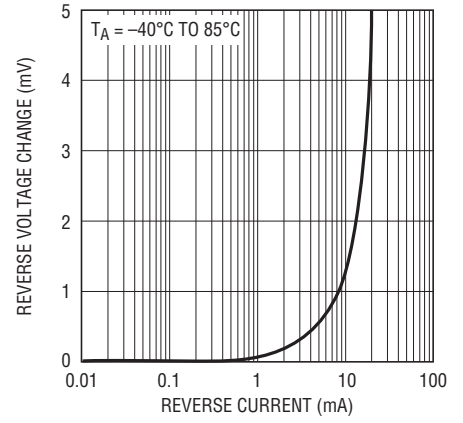

1634-5 G03

**Reverse Dynamic Impedance**

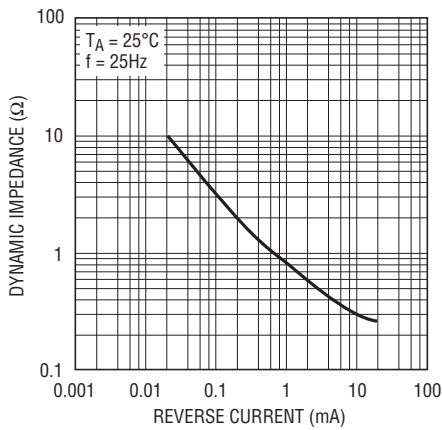

1635-5 G04

**Dynamic Impedance vs Frequency**

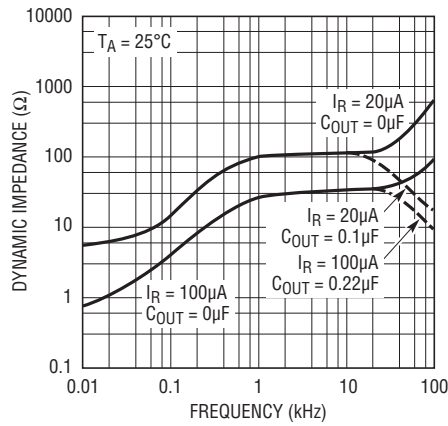

1634-5 G05

**Forward Characteristics**

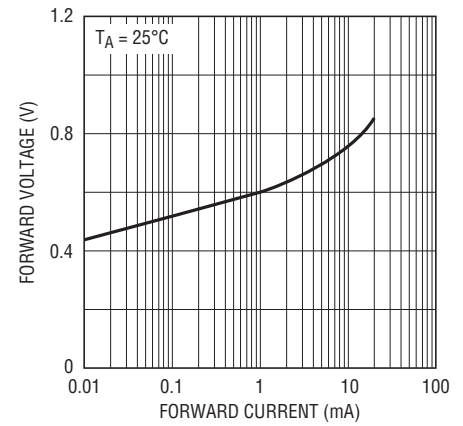

1634-2.5 G06

**0.1Hz to 10Hz Noise**

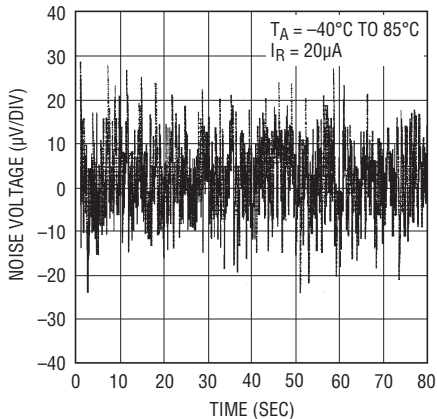

1634-5 G06

**Response Time**

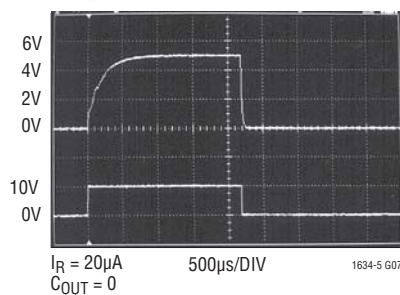

1634-5 G07

**Response Time**

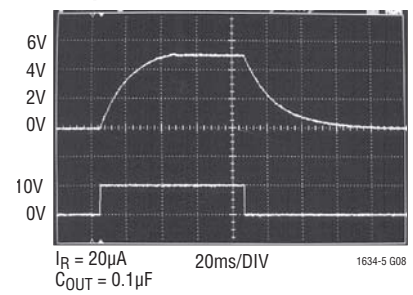

1634-5 G08

## APPLICATIONS INFORMATION

The reverse characteristics of the LT1634 behave like a resistor in parallel with a Zener diode. This simple, well behaved characteristic is important to the proper operation of circuits like Figure 1. The adjustable output

voltage reference depends upon positive feedback from the LT1495's output to start-up and regulate the bias current for the LT1634.

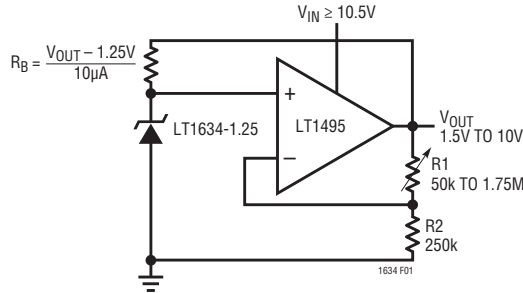
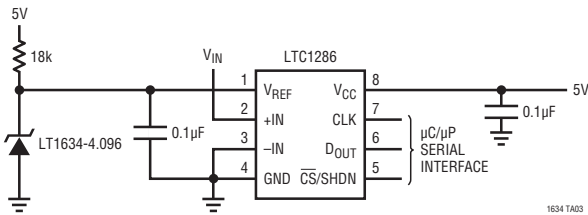

Figure 1. Adjustable Output Voltage Reference

## TYPICAL APPLICATIONS

### Reference for Micropower A/D Converter



### The LT1634-5 Generates the LTC1448 Dual 12-Bit DAC's Reference and Supply Voltage

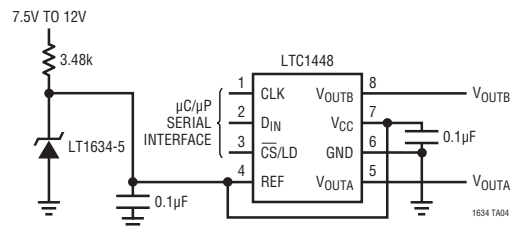

## PACKAGE DESCRIPTION

### S8 Package 8-Lead Plastic Small Outline (Narrow 0.150 Inch) (Reference LTC DWG # 05-08-1610)

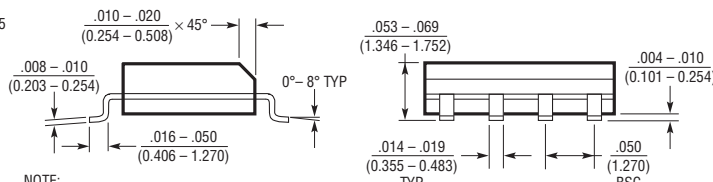
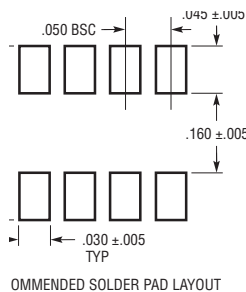

- NOTE:  
1. DIMENSIONS IN INCHES (MILLIMETERS)  
2. DRAWING NOT TO SCALE  
3. THESE DIMENSIONS DO NOT INCLUDE MOLD FLASH OR PROTRUSIONS. MOLD FLASH OR PROTRUSIONS SHALL NOT EXCEED .006" (0.15mm)

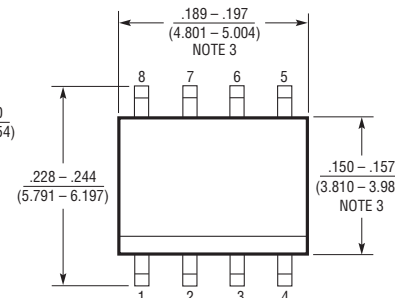

5208 0202x

1634fe

# PACKAGE DESCRIPTION

## MS8 Package 8-Lead Plastic MSOP (Reference LTC DWG # 05-08-1660)

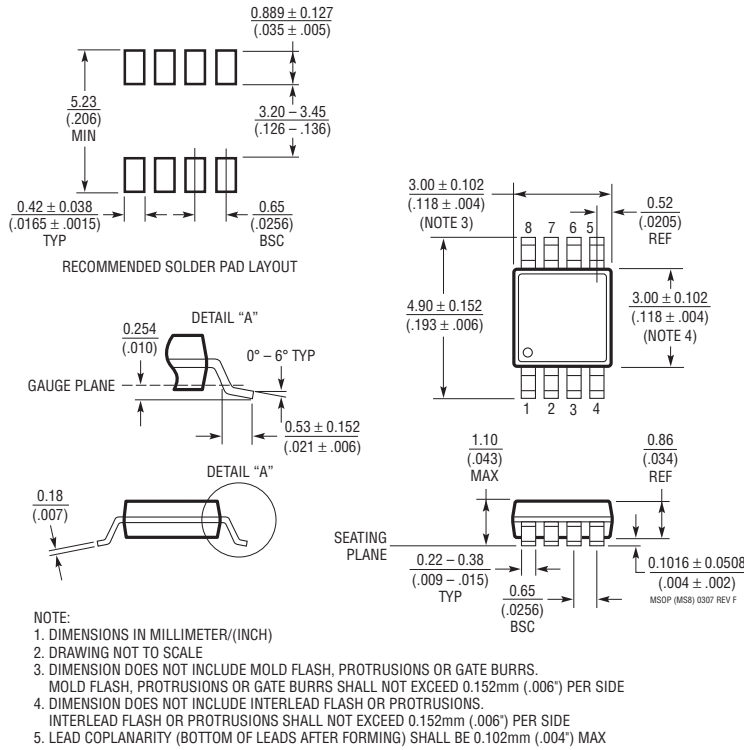

## Z Package 3-Lead Plastic TO-92 (Similar to TO-226) (Reference LTC DWG # 05-08-1410)

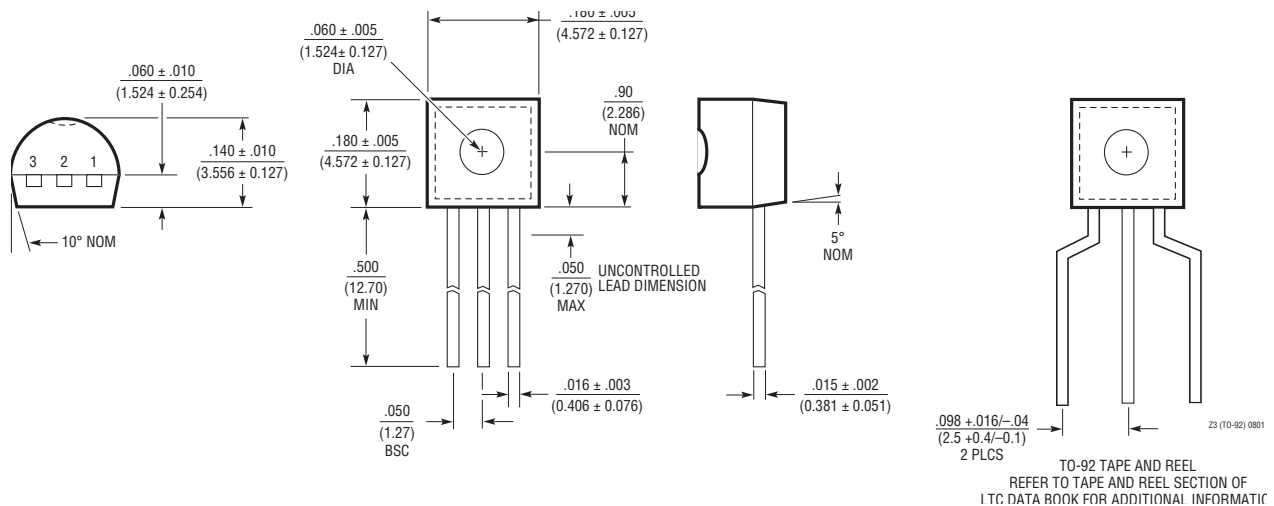

## TYPICAL APPLICATIONS

### Single Cell Li-Ion Battery Supervisory Circuit ( $I_Q = 20\mu A$ )

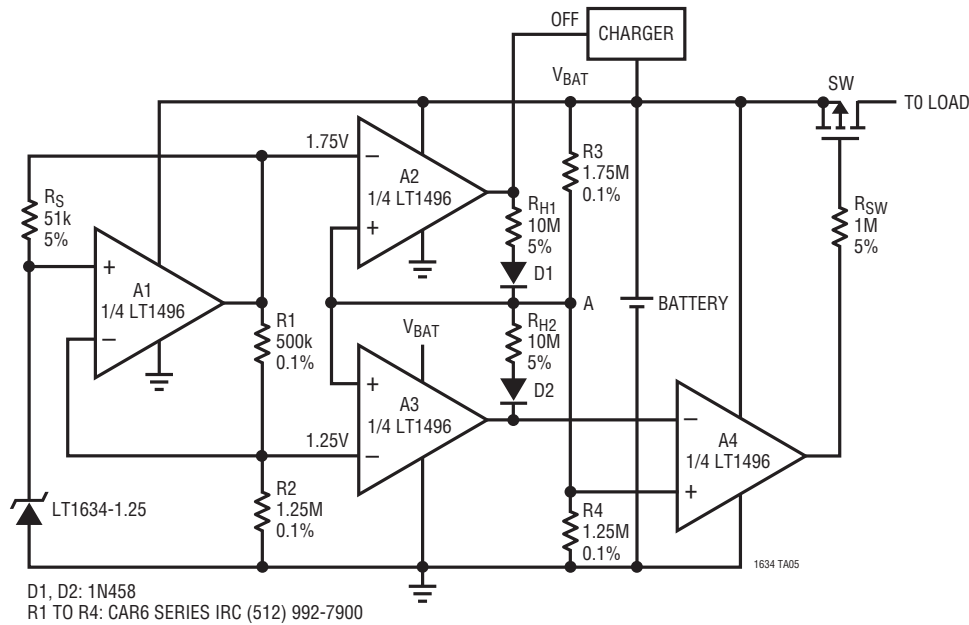

### Micropower Voltage and Current Reference

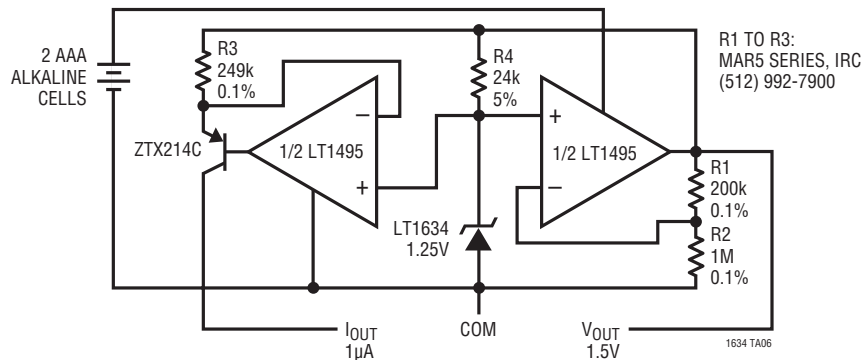

## RELATED PARTS

| PART NUMBER | DESCRIPTION                              | COMMENTS   |
|-------------|--|--|
| LTC1440     | Micropower Comparator with Reference     | 3.7μA Max Supply Current, 1% 1.182V Reference, MSOP, PDIP and SO-8 Packages                            |
| LT1460      | Micropower Series Reference              | 0.075% Max, 10ppm/°C Max Drift, 2.5V, 5V and 10V Versions, MSOP, PDIP, SO-8, SOT-23 and TO-92 Packages |
| LT1495      | 1.5μA Precision Rail-to-Rail Dual Op Amp | 1.5μA Max Supply Current, 100pA Max IOS  |
| LTC1540     | Nanopower Comparator with Reference      | 600nA Max Supply Current, 2% 1.182V Reference, MSOP and SO-8 Packages                                  |