

FEATURES

- 58 dB typical small signal gain**
- 43 dBm typical saturated output power**
- 48 dBm typical output IP3**
- 6 dB maximum noise figure**
- Operates from 12 V and 28 V supplies**
- Built-in bias sequencing**
- Enable pin to provide shutdown capability**

APPLICATIONS

- Telecom infrastructure**
- Test instrumentation**
- Military**

FUNCTIONAL BLOCK DIAGRAM

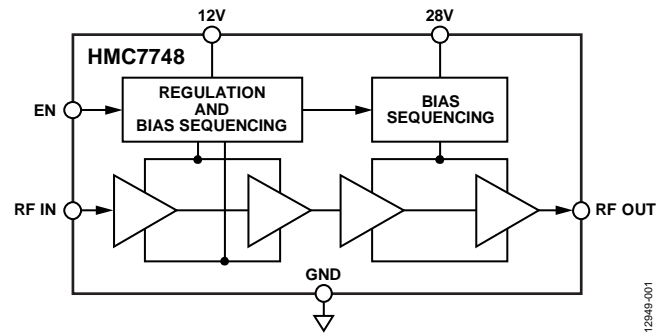

Figure 1.

12949-001

GENERAL DESCRIPTION

The [HMC7748](#) is a multistage power amplifier (PA) that provides 25 W of saturated output power across the band of 2 GHz to 6 GHz. It draws 0.7 A from a 12 V supply and up to 4 A from a 28 V supply. Input signals of as much as -8 dBm are acceptable, and the module has small signal gain of 60 dB.

The 12 V supply is regulated internally and generates the negative voltage required for the gate bias. Built-in bias sequencing prevents the drain voltages for the amplifier stages from being applied without the negative voltage present, which protects the amplifiers if 28 V is applied without 12 V supply applied.

An external enable pin causes the module to remain in shutdown mode unless the pin is pulled to ground. This pin provides a means of turning the amplifiers off and on without cycling the power supplies.

TABLE OF CONTENTS

Features	1	ESD Caution.....	4
Applications.....	1	Pin Configuration and Function Descriptions.....	5
Functional Block Diagram	1	Typical Performance Characteristics	6
General Description	1	Applications Information	8
Revision History	2	Outline Dimensions	9
Specifications.....	3	Ordering Guide	9
Absolute Maximum Ratings.....	4		

REVISION HISTORY

11/2016—Revision 0: Initial Version

SPECIFICATIONS

Unless otherwise noted, specifications are with bias voltages of 12 V and 28 V, EN pin pulled to ground, and a baseplate temperature of 25°C.

Table 1.

Parameter	Min	Typ	Max	Unit	Test Conditions/Comments
FREQUENCY RANGE	2		6	GHz	
GAIN					
Small Signal Gain	50	58		dB	-55 dBm input, room temperature
RF OUTPUT POWER					
1 dB Compression (P1dB)	35	38		dBm	1 MHz tone spacing
Saturated Output Power (P _{SAT})	41	43		dBm	
Output Third-Order Intercept (IP3)		48		dBm	
Noise Figure		5	6	dB	
VOLTAGE STANDING WAVE RATIO (VSWR)					
Input			2:1		Small signal operation
Output		2:1			
CURRENT					
12 V Supply		0.7	0.9	A	Small signal operation
28 V Supply		1.7		A	
			4	A	Saturated output operation

ABSOLUTE MAXIMUM RATINGS

Table 2.

Parameter	Rating
12 V Bias Line	20 V
28 V Bias Line	32 V
Maximum Voltage, EN	5 V
RF Input Level	-8 dBm
Output VSWR	6:1
Operating Temperature Range	-40°C to +70°C
Storage Temperature Range	-55°C to +150°C
ESD Sensitivity, Human Body Model (HBM)	Class 1A

Stresses at or above those listed under Absolute Maximum Ratings may cause permanent damage to the product. This is a stress rating only; functional operation of the product at these or any other conditions above those indicated in the operational section of this specification is not implied. Operation beyond the maximum operating conditions for extended periods may affect product reliability.

ESD CAUTION



ESD (electrostatic discharge) sensitive device. Charged devices and circuit boards can discharge without detection. Although this product features patented or proprietary protection circuitry, damage may occur on devices subjected to high energy ESD. Therefore, proper ESD precautions should be taken to avoid performance degradation or loss of functionality.

PIN CONFIGURATION AND FUNCTION DESCRIPTIONS

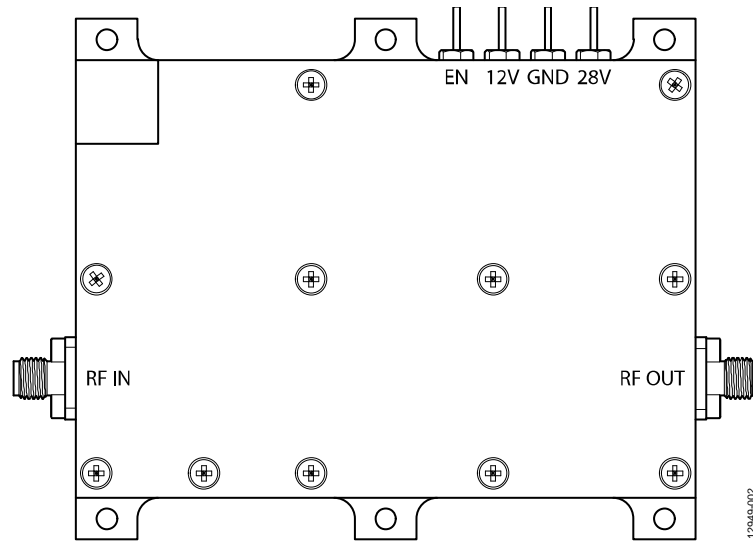

Figure 2. Pin Configuration

Table 3. Pin Function Descriptions

Pin No.	Mnemonic	Description
J1	RF IN	RF Input. RF IN has a frequency range of 2 GHz to 6 GHz, and input signals of -10 dBm and a maximum of -8 dBm.
J2	RF OUT	RF Output. RF OUT has a frequency range of 2 GHz to 6 GHz.
J3	28V	28 V, 4 A Supply.
J4	GND	Ground Connection.
J5	12V	12 V, 0.7 A Supply.
J6	EN	Enable. Pull this pin to ground to enable the PA.

TYPICAL PERFORMANCE CHARACTERISTICS

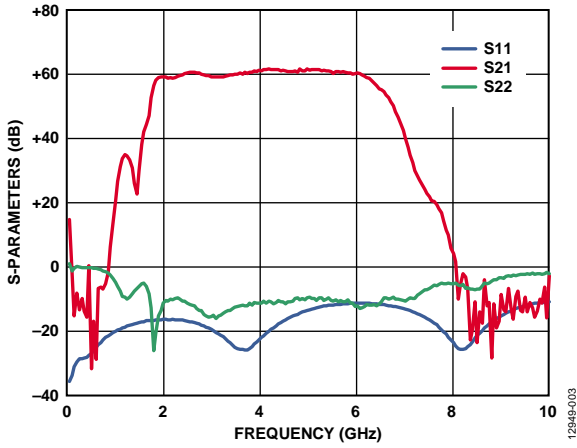

Figure 3. S-Parameters vs. Frequency at 25°C

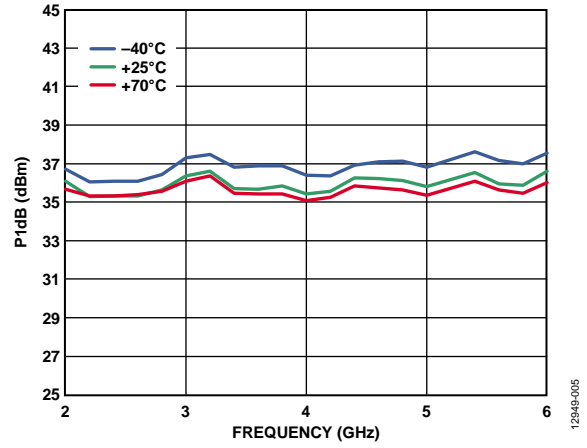

Figure 5. P1dB vs. Frequency for Various Temperatures

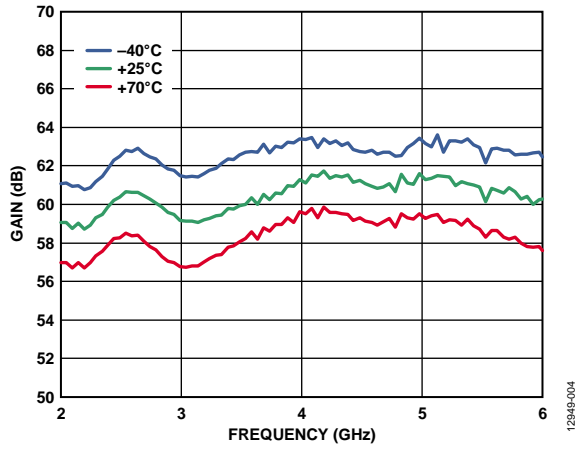

Figure 4. Small Signal Gain vs. Frequency for Various Temperatures

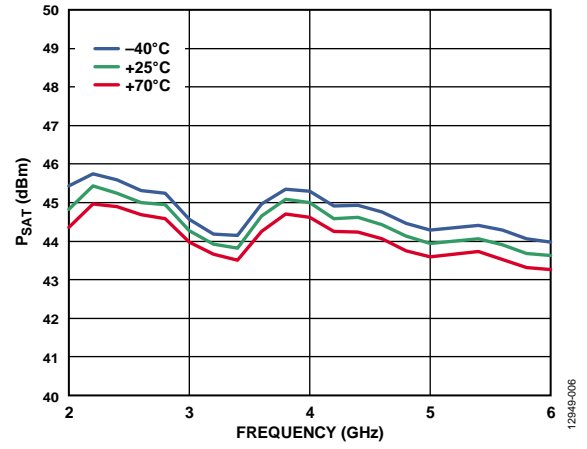

Figure 6. Saturated Power (P_{SAT}) vs. Frequency for Various Temperatures

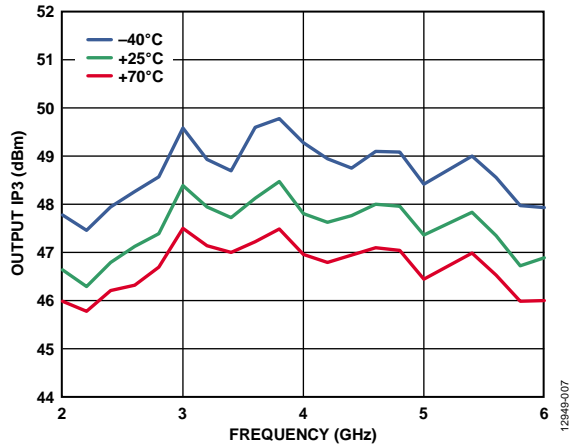

Figure 7. Output IP3 vs. Frequency for Various Temperatures

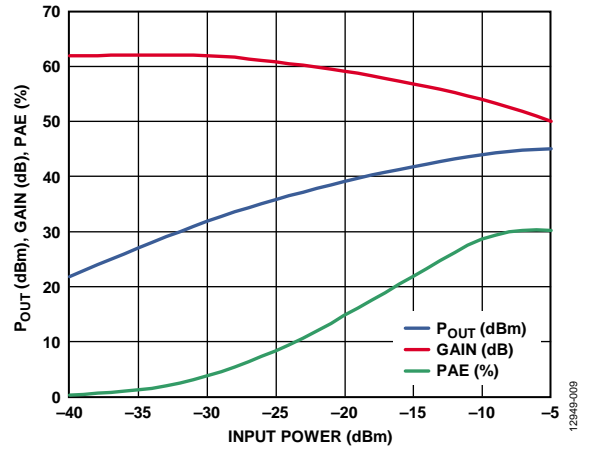

Figure 9. Power Compression at 4 GHz

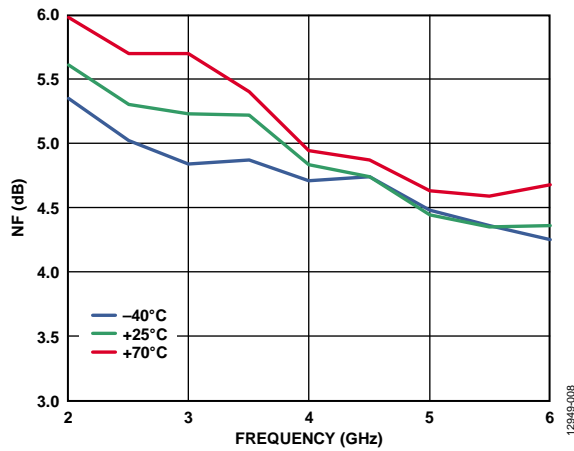

Figure 8. Noise Figure (NF) vs. Frequency for Various Temperatures

APPLICATIONS INFORMATION

The [HMC7748](#) multistage amplifier is designed to be mounted to a heat sink of a suitable size such that during operation, the backside case temperature never exceeds 70°C. Operation of the unit at backside case temperatures greater than 70°C results in the reduced life of the unit.

Prior to applying dc voltages, terminate both the RF input and RF output to 50 Ω. Never disconnect the RF output when dc is applied to the unit.

The EN pin (PA enable) must be tied TTL logic low or to ground to operate the unit. If the PA enable is not required for an application, it can be hardwired to ground.

The [HMC7748](#) contains depletion mode devices and has built-in bias sequencing circuitry, which means that if the 28 V dc voltage is applied first, there is no damage to the unit.

To turn on the amplifier, complete the following steps:

1. Verify that the dc connections are correct.
2. Verify that the PA enable (EN pin) is pulled high.
3. Verify that the RF input is off.
4. Apply 12 V dc to the 12V pin.
5. Apply 28 V dc to the 28V pin.
6. Pull the PA enable (EN pin) to logic low or to ground.
7. Apply the RF input, ensuring that the power level is less than -8 dBm.

To turn off the amplifier, complete the following steps:

1. Turn the RF input off.
2. Apply a TTL logic high to the PA enable (EN pin).
3. Turn off the 28 V dc supply.
4. Turn off the 12 V dc supply.

OUTLINE DIMENSIONS

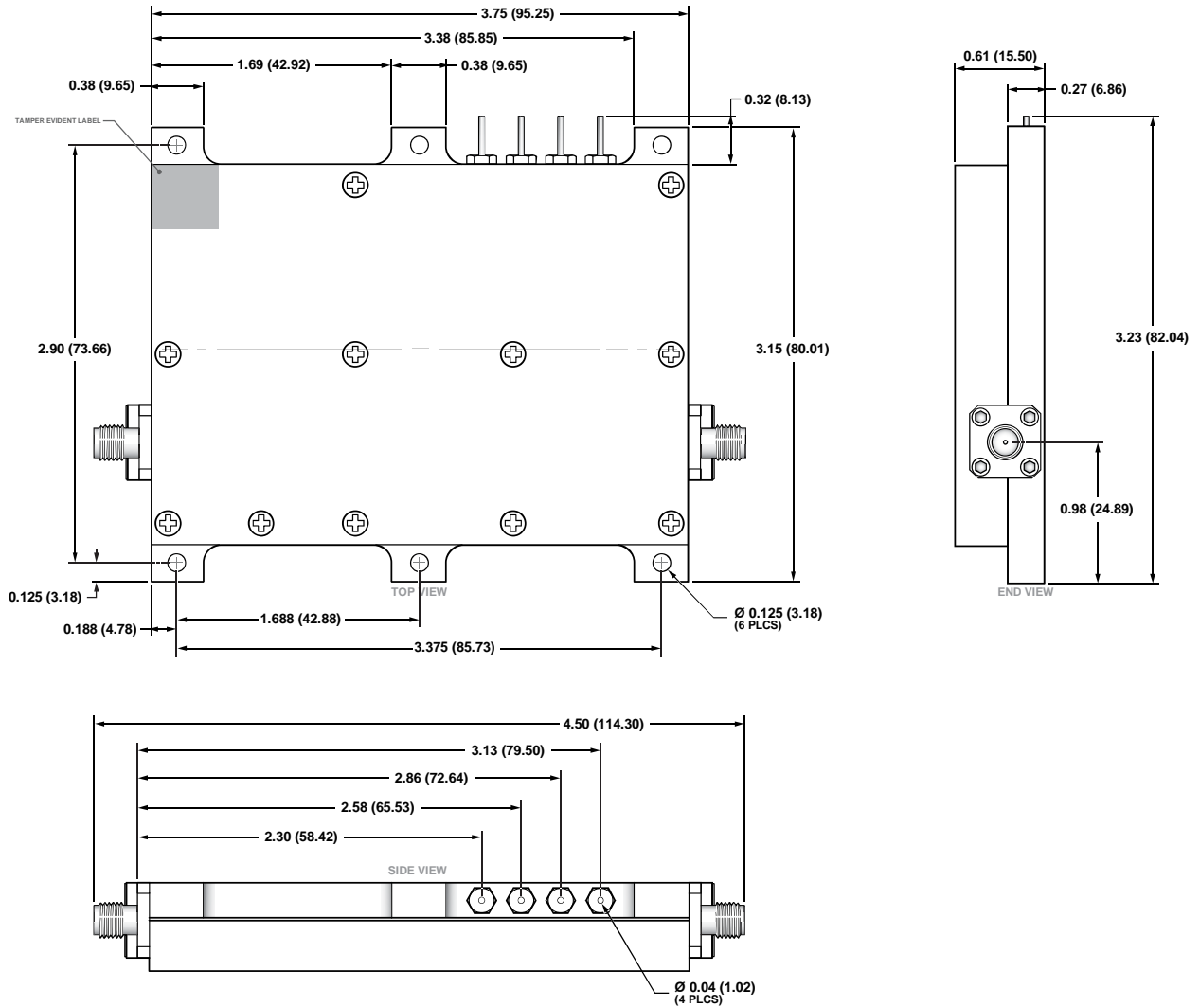

CONTROLLING DIMENSIONS ARE IN INCHES; MILLIMETER DIMENSIONS (IN PARENTHESES) ARE ROUNDED-OFF INCH EQUIVALENTS FOR REFERENCE ONLY AND ARE NOT APPROPRIATE FOR USE IN DESIGN.

Figure 10. 6-Lead Module with Connector Interface [MODULE] (HML-6-1)
Dimensions shown in inches and (millimeters)

ORDERING GUIDE

Model	Temperature Range	Package Description	Package Option
HMC7748	-40°C to +70°C	6-Lead Module with Connector Interface [MODULE]	HML-6-1