

# Standalone Linear Li-Ion Battery Charger with Thermal Regulation in ThinSOT

## FEATURES

- Programmable Charge Current Up to 800mA
- No MOSFET, Sense Resistor or Blocking Diode Required
- Complete Linear Charger in ThinSOT™ Package for Single Cell Lithium-Ion Batteries
- Constant-Current/Constant-Voltage Operation with Thermal Regulation\* to Maximize Charge Rate Without Risk of Overheating
- Charges Single Cell Li-Ion Batteries Directly from USB Port
- Preset 4.2V Charge Voltage with  $\pm 1\%$  Accuracy
- Charge Current Monitor Output for Gas Gauging\*
- Automatic Recharge
- Charge Status Output Pin
- C/10 Charge Termination
- 25 $\mu$ A Supply Current in Shutdown
- 2.9V Trickle Charge Threshold (LTC4054)
- Available Without Trickle Charge (LTC4054X)
- Soft-Start Limits Inrush Current
- Available in 5-Lead SOT-23 Package

## APPLICATIONS

- Cellular Telephones, PDAs, MP3 Players
- Charging Docks and Cradles
- Bluetooth Applications

## DESCRIPTION

The LTC<sup>®</sup>4054 is a complete constant-current/constant-voltage linear charger for single cell lithium-ion batteries. Its ThinSOT package and low external component count make the LTC4054 ideally suited for portable applications. Furthermore, the LTC4054 is specifically designed to work within USB power specifications.

No external sense resistor is needed, and no blocking diode is required due to the internal MOSFET architecture. Thermal feedback regulates the charge current to limit the die temperature during high power operation or high ambient temperature. The charge voltage is fixed at 4.2V, and the charge current can be programmed externally with a single resistor. The LTC4054 automatically terminates the charge cycle when the charge current drops to 1/10th the programmed value after the final float voltage is reached.

When the input supply (wall adapter or USB supply) is removed, the LTC4054 automatically enters a low current state, dropping the battery drain current to less than 2 $\mu$ A. The LTC4054 can be put into shutdown mode, reducing the supply current to 25 $\mu$ A.

Other features include charge current monitor, undervoltage lockout, automatic recharge and a status pin to indicate charge termination and the presence of an input voltage.

LT, LTC and LT are registered trademarks of Linear Technology Corporation.

ThinSOT is a trademark of Linear Technology Corporation.

\*U.S. Patent No. 6,522,118

## TYPICAL APPLICATION

600mA Single Cell Li-Ion Charger

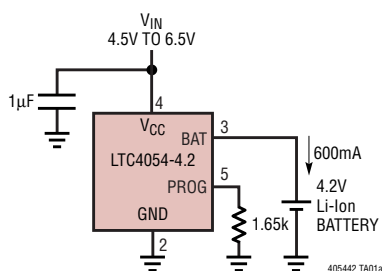

Complete Charge Cycle (750mAh Battery)

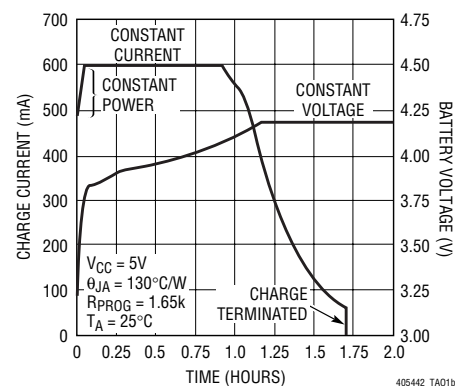

## ABSOLUTE MAXIMUM RATINGS

(Note 1)

Input Supply Voltage ( $V_{CC}$ )	-0.3V to 10V
PROG	-0.3V to $V_{CC} + 0.3V$
BAT	-0.3V to 7V
CHRG	-0.3V to 10V
BAT Short-Circuit Duration	Continuous
BAT Pin Current	800mA
PROG Pin Current	800 $\mu$ A
Maximum Junction Temperature	125°C
Operating Ambient Temperature Range	
(Note 2)	-40°C to 85°C
Storage Temperature Range	-65°C to 125°C
Lead Temperature (Soldering, 10 sec)	300°C

## PACKAGE/ORDER INFORMATION

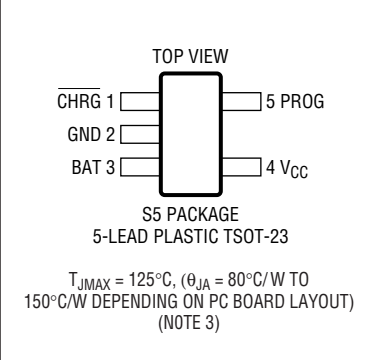
	ORDER PART NUMBER
	LTC4054ES5-4.2 LTC4054XES5-4.2
	S5 PART MARKING
	LTH7 LTADY

Consult LTC Marketing for parts specified with wider operating temperature ranges.

## ELECTRICAL CHARACTERISTICS

The ● denotes specifications which apply over the full operating temperature range, otherwise specifications are at  $T_A = 25^\circ\text{C}$ .  $V_{CC} = 5V$ , unless otherwise noted.

SYMBOL	PARAMETER	CONDITIONS	MIN	TYP	MAX	UNITS
$V_{CC}$	Input Supply Voltage		● 4.25		6.5	V
$I_{CC}$	Input Supply Current	Charge Mode (Note 4), $R_{PROG} = 10k$ Standby Mode (Charge Terminated) Shutdown Mode ( $R_{PROG}$ Not Connected, $V_{CC} < V_{BAT}$ , or $V_{CC} < V_{UV}$ )	●	300 200 25	2000 500 50	$\mu$ A $\mu$ A $\mu$ A
$V_{FLOAT}$	Regulated Output (Float) Voltage	$0^\circ\text{C} \leq T_A \leq 85^\circ\text{C}$ , $I_{BAT} = 40\text{mA}$	4.158	4.2	4.242	V
$I_{BAT}$	BAT Pin Current	$R_{PROG} = 10k$ , Current Mode $R_{PROG} = 2k$ , Current Mode Standby Mode, $V_{BAT} = 4.2V$ Shutdown Mode ( $R_{PROG}$ Not Connected) Sleep Mode, $V_{CC} = 0V$	● 93 ● 465 ● 0	100 500 -2.5	107 535 -6	mA mA $\mu$ A
$I_{TRIKL}$	Trickle Charge Current	$V_{BAT} < V_{TRIKL}$ , $R_{PROG} = 2k$ (Note 5)	● 20	45	70	mA
$V_{TRIKL}$	Trickle Charge Threshold Voltage	$R_{PROG} = 10k$ , $V_{BAT}$ Rising (Note 5)	2.8	2.9	3.0	V
$V_{TRHYS}$	Trickle Charge Hysteresis Voltage	$R_{PROG} = 10k$ (Note 5)	60	80	110	mV
$V_{UV}$	$V_{CC}$ Undervoltage Lockout Threshold	From $V_{CC}$ Low to High	● 3.7	3.8	3.92	V
$V_{UVHYS}$	$V_{CC}$ Undervoltage Lockout Hysteresis		● 150	200	300	mV
$V_{MSD}$	Manual Shutdown Threshold Voltage	PROG Pin Rising PROG Pin Falling	● 1.15 ● 0.9	1.21 1.0	1.30 1.1	V V
$V_{ASD}$	$V_{CC} - V_{BAT}$ Lockout Threshold Voltage	$V_{CC}$ from Low to High $V_{CC}$ from High to Low	70 5	100 30	140 50	mV mV
$I_{TERM}$	C/10 Termination Current Threshold	$R_{PROG} = 10k$ (Note 6) $R_{PROG} = 2k$	● 0.085 ● 0.085	0.10 0.10	0.115 0.115	mA/mA mA/mA
$V_{PROG}$	PROG Pin Voltage	$R_{PROG} = 10k$ , Current Mode	● 0.93	1.0	1.07	V
$I_{CHRG}$	CHRG Pin Weak Pull-Down Current	$V_{CHRG} = 5V$	8	20	35	$\mu$ A
$V_{CHRG}$	CHRG Pin Output Low Voltage	$I_{CHRG} = 5\text{mA}$		0.35	0.6	V
$\Delta V_{RECHRG}$	Recharge Battery Threshold Voltage	$V_{FLOAT} - V_{RECHRG}$	100	150	200	mV

**ELECTRICAL CHARACTERISTICS** The ● denotes specifications which apply over the full operating temperature range, otherwise specifications are at  $T_A = 25^\circ\text{C}$ .  $V_{CC} = 5\text{V}$ , unless otherwise noted.

SYMBOL	PARAMETER	CONDITIONS	MIN	TYP	MAX	UNITS
$T_{LIM}$	Junction Temperature in Constant Temperature Mode			120		$^\circ\text{C}$
$R_{ON}$	Power FET "ON" Resistance (Between $V_{CC}$ and BAT)			600		$\text{m}\Omega$
$t_{SS}$	Soft-Start Time	$I_{BAT} = 0$ to $I_{BAT} = 1000\text{V}/R_{PROG}$		100		$\mu\text{s}$
$t_{RECHARGE}$	Recharge Comparator Filter Time	$V_{BAT}$ High to Low	0.75	2	4.5	ms
$t_{TERM}$	Termination Comparator Filter Time	$I_{BAT}$ Falling Below $I_{CHG}/10$	400	1000	2500	$\mu\text{s}$
$I_{PROG}$	PROG Pin Pull-Up Current			3		$\mu\text{A}$

**Note 1:** Absolute Maximum Ratings are those values beyond which the life of the device may be impaired.  
**Note 2:** The LTC4054E-4.2 and the LTC4054XE-4.2 are guaranteed to meet performance specifications from  $0^\circ\text{C}$  to  $70^\circ\text{C}$ . Specifications over the  $-40^\circ\text{C}$  to  $85^\circ\text{C}$  operating temperature range are assured by design, characterization and correlation with statistical process controls.  
**Note 3:** See Thermal Considerations.

**Note 4:** Supply current includes PROG pin current (approximately  $100\mu\text{A}$ ) but does not include any current delivered to the battery through the BAT pin (approximately  $100\text{mA}$ ).  
**Note 5:** This parameter is not applicable to the LTC4054X.  
**Note 6:**  $I_{TERM}$  is expressed as a fraction of measured full charge current with indicated PROG resistor.

**TYPICAL PERFORMANCE CHARACTERISTICS**

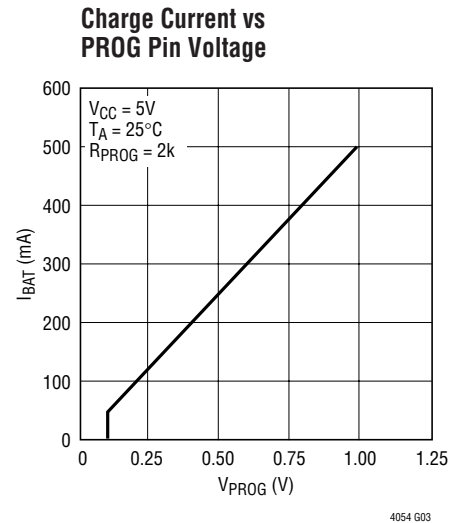
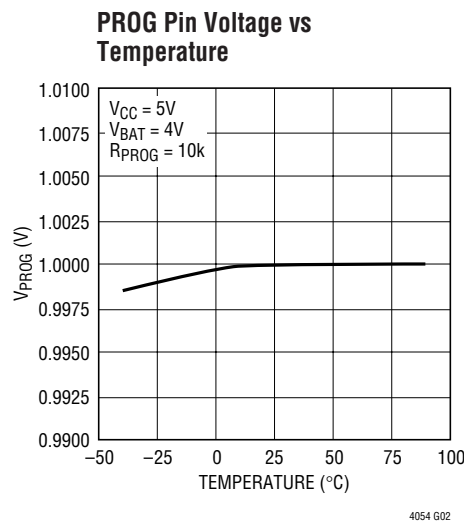
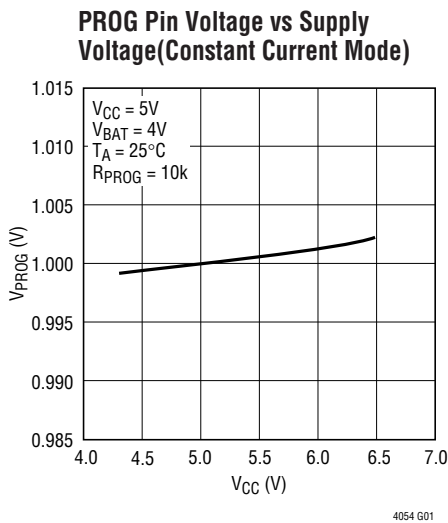

# TYPICAL PERFORMANCE CHARACTERISTICS

**PROG Pin Pull-Up Current vs Temperature and Supply Voltage**

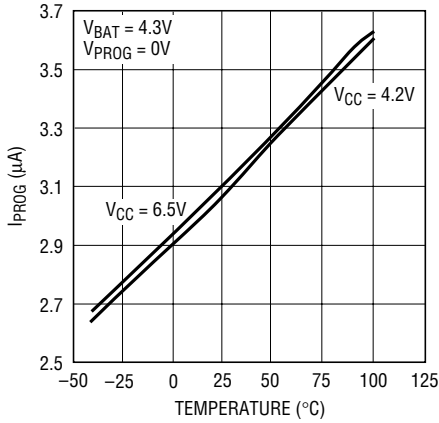

4054 G04

**PROG Pin Current vs PROG Pin Voltage (Pull-Up Current)**

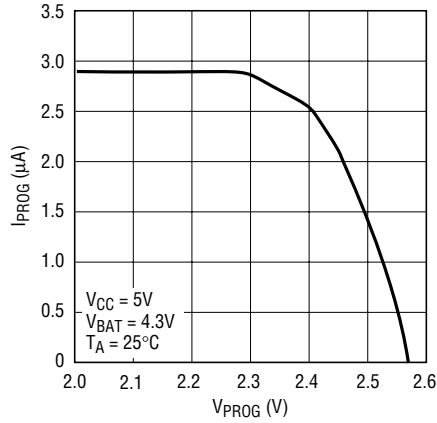

4054 G05

**PROG Pin Current vs PROG Pin Voltage (Clamp Current)**

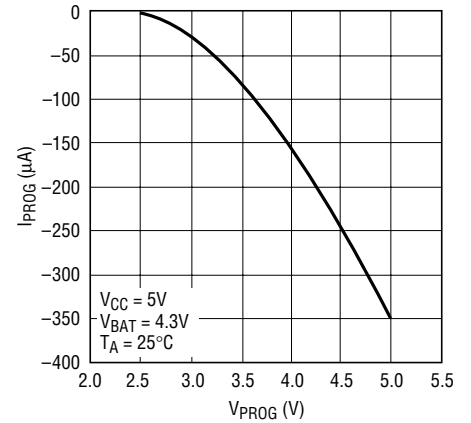

4054 G06

**Regulated Output (Float) Voltage vs Charge Current**

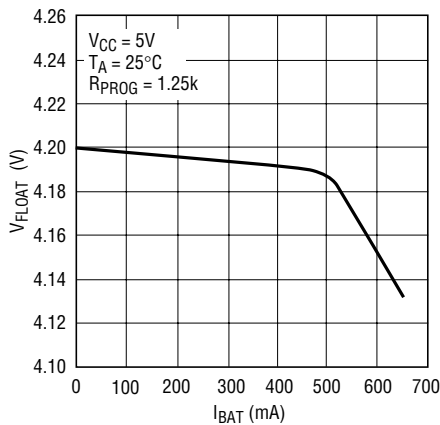

4054 G07

**Regulated Output (Float) Voltage vs Temperature**

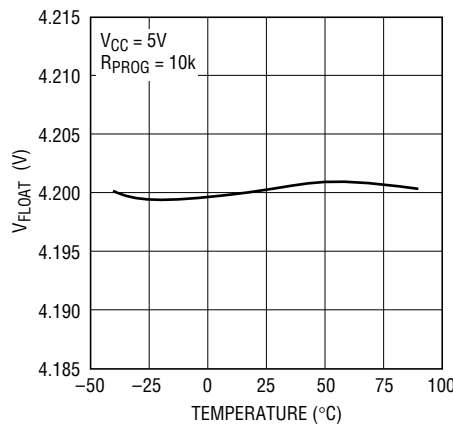

4054 G08

**Regulated Output (Float) Voltage vs Supply Voltage**

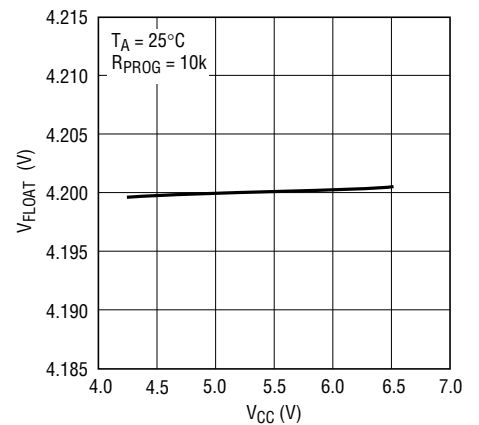

4054 G09

**CHRG Pin I-V Curve (Strong Pull-Down State)**

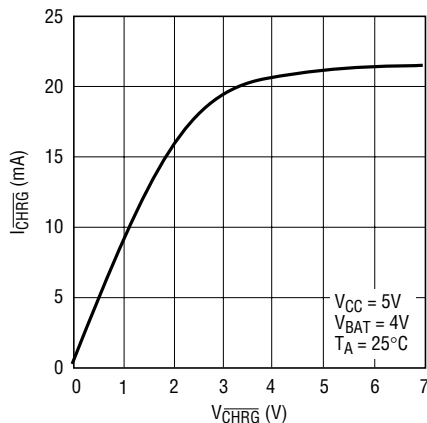

4054 G10

**CHRG Pin Current vs Temperature (Strong Pull-Down State)**

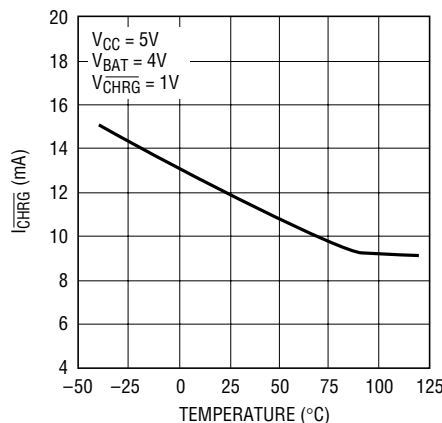

4054 G11

**CHRG Pin I-V Curve (Weak Pull-Down State)**

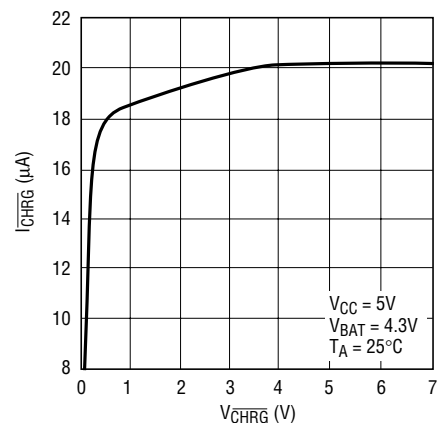

4054 G12

405442xf

# TYPICAL PERFORMANCE CHARACTERISTICS

**CHRG Pin Current vs Temperature (Weak Pull-Down State)**

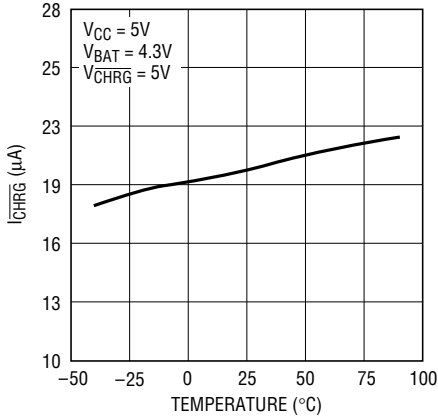

4054 G13

**Trickle Charge Current vs Temperature**

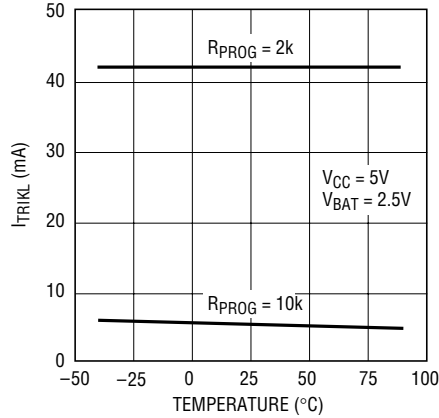

4054 G14

**Trickle Charge Current vs Supply Voltage**

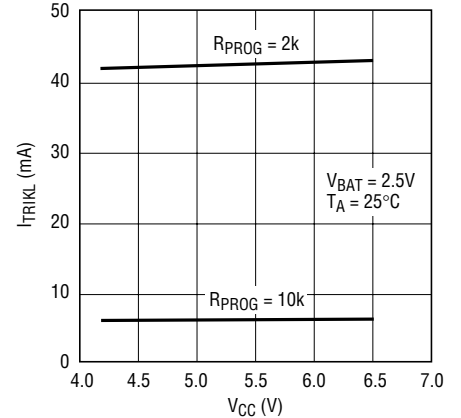

4054 G15

**Trickle Charge Threshold vs Temperature**

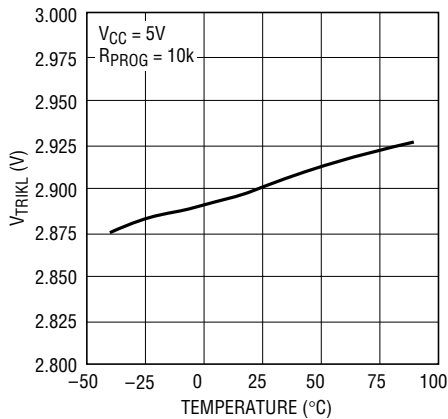

4054 G16

**Charge Current vs Battery Voltage**

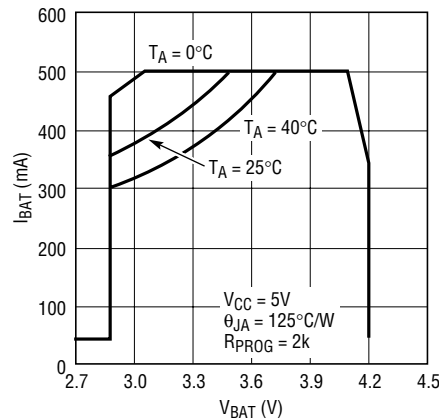

4054 G17

**Charge Current vs Supply Voltage**

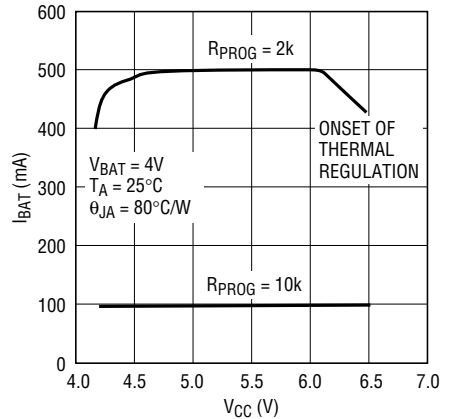

4054 G18

**Charge Current vs Ambient Temperature**

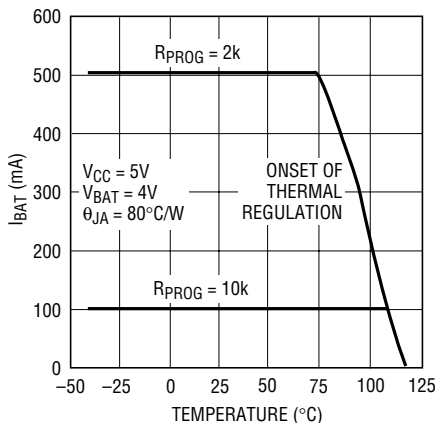

4054 G19

**Recharge Voltage Threshold vs Temperature**

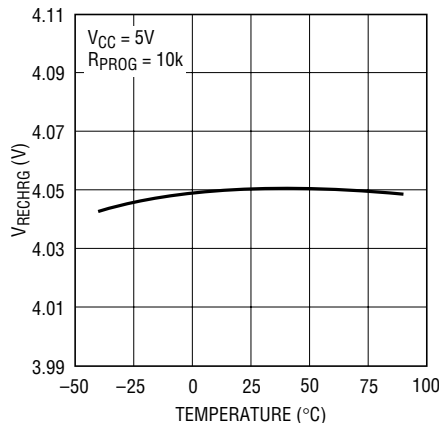

4054 G20

**Power FET "ON" Resistance vs Temperature**

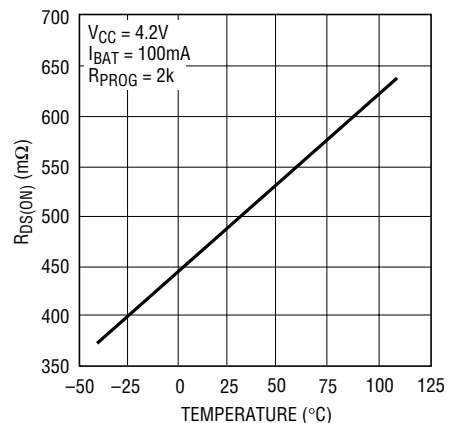

4054 G21

## PIN FUNCTIONS

**CHRG (Pin 1):** Open-Drain Charge Status Output. When the battery is charging, the  $\overline{\text{CHRG}}$  pin is pulled low by an internal N-channel MOSFET. When the charge cycle is completed, a weak pull-down of approximately  $20\mu\text{A}$  is connected to the  $\overline{\text{CHRG}}$  pin, indicating an “AC present” condition. When the LTC4054 detects an undervoltage lockout condition,  $\overline{\text{CHRG}}$  is forced high impedance.

**GND (Pin 2):** Ground.

**BAT (Pin 3):** Charge Current Output. Provides charge current to the battery and regulates the final float voltage to 4.2V. An internal precision resistor divider from this pin sets the float voltage which is disconnected in shutdown mode.

**V<sub>CC</sub> (Pin 4):** Positive Input Supply Voltage. Provides power to the charger.  $V_{\text{CC}}$  can range from 4.25V to 6.5V and should be bypassed with at least a  $1\mu\text{F}$  capacitor. When  $V_{\text{CC}}$  drops to within 30mV of the BAT pin voltage, the LTC4054 enters shutdown mode, dropping  $I_{\text{BAT}}$  to less than  $2\mu\text{A}$ .

**PROG (Pin 5):** Charge Current Program, Charge Current Monitor and Shutdown Pin. The charge current is programmed by connecting a 1% resistor,  $R_{\text{PROG}}$ , to ground. When charging in constant-current mode, this pin serves to 1V. In all modes, the voltage on this pin can be used to measure the charge current using the following formula:

$$I_{\text{BAT}} = (V_{\text{PROG}}/R_{\text{PROG}}) \cdot 1000$$

The PROG pin can also be used to shut down the charger. Disconnecting the program resistor from ground allows a  $3\mu\text{A}$  current to pull the PROG pin high. When it reaches the 1.21V shutdown threshold voltage, the charger enters shutdown mode, charging stops and the input supply current drops to  $25\mu\text{A}$ . This pin is also clamped to approximately 2.4V. Driving this pin to voltages beyond the clamp voltage will draw currents as high as 1.5mA. Reconnecting  $R_{\text{PROG}}$  to ground will return the charger to normal operation.

**BLOCK DIAGRAM**

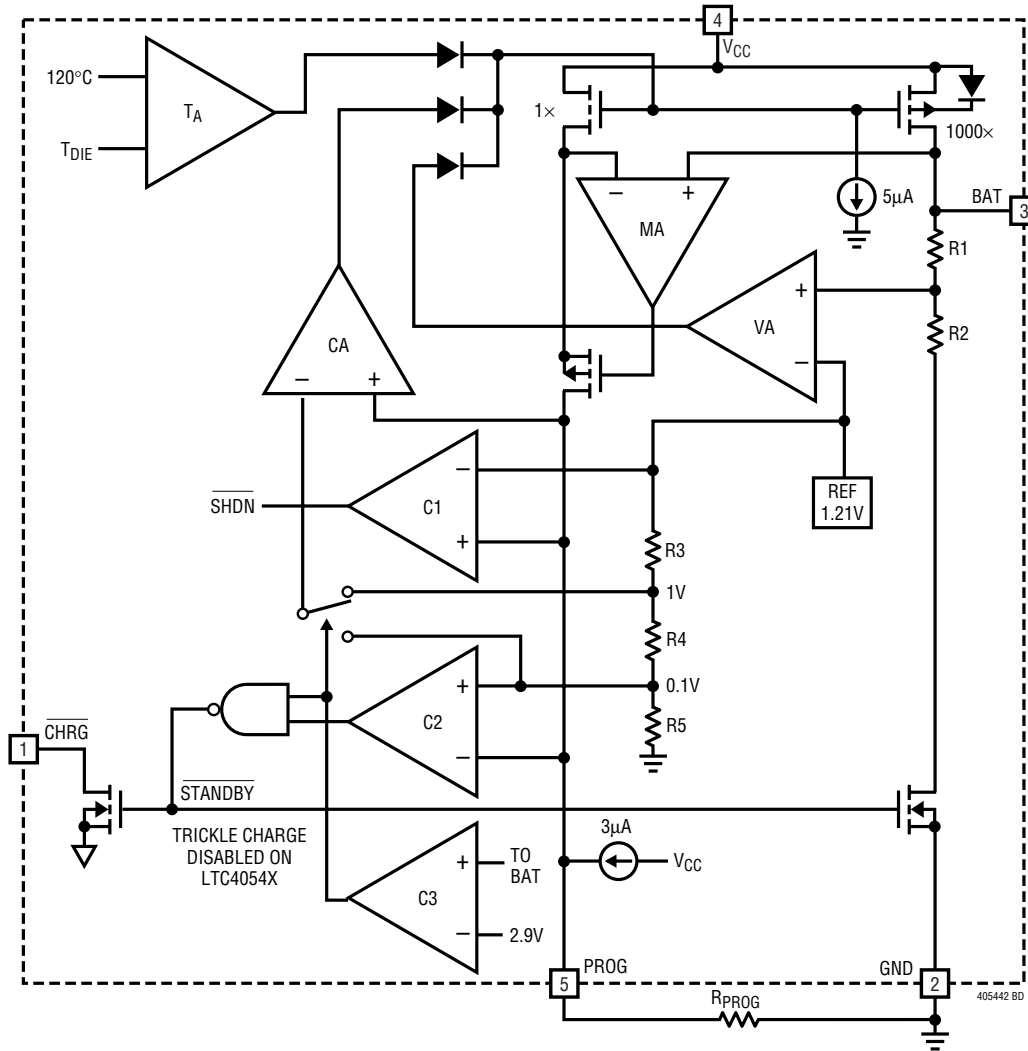

## OPERATION

The LTC4054 is a single cell lithium-ion battery charger using a constant-current/constant-voltage algorithm. It can deliver up to 800mA of charge current (using a good thermal PCB layout) with a final float voltage accuracy of  $\pm 1\%$ . The LTC4054 includes an internal P-channel power MOSFET and thermal regulation circuitry. No blocking diode or external current sense resistor is required; thus, the basic charger circuit requires only two external components. Furthermore, the LTC4054 is capable of operating from a USB power source.

### Normal Charge Cycle

A charge cycle begins when the voltage at the  $V_{CC}$  pin rises above the UVLO threshold level and a 1% program resistor is connected from the PROG pin to ground or when a battery is connected to the charger output. If the BAT pin is less than 2.9V, the charger enters trickle charge mode. In this mode, the LTC4054 supplies approximately 1/10 the programmed charge current to bring the battery voltage up to a safe level for full current charging. (Note: The LTC4054X does not include this trickle charge feature).

When the BAT pin voltage rises above 2.9V, the charger enters constant-current mode, where the programmed charge current is supplied to the battery. When the BAT pin approaches the final float voltage (4.2V), the LTC4054 enters constant-voltage mode and the charge current begins to decrease. When the charge current drops to 1/10 of the programmed value, the charge cycle ends.

### Programming Charge Current

The charge current is programmed using a single resistor from the PROG pin to ground. The battery charge current is 1000 times the current out of the PROG pin. The program resistor and the charge current are calculated using the following equations:

$$R_{\text{PROG}} = \frac{1000V}{I_{\text{CHG}}}, \quad I_{\text{CHG}} = \frac{1000V}{R_{\text{PROG}}}$$

The charge current out of the BAT pin can be determined at any time by monitoring the PROG pin voltage using the following equation:

$$I_{\text{BAT}} = \frac{V_{\text{PROG}}}{R_{\text{PROG}}} \cdot 1000$$

### Charge Termination

A charge cycle is terminated when the charge current falls to 1/10th the programmed value after the final float voltage is reached. This condition is detected by using an internal, filtered comparator to monitor the PROG pin. When the PROG pin voltage falls below 100mV<sup>1</sup> for longer than  $t_{\text{TERM}}$  (typically 1ms), charging is terminated. The charge current is latched off and the LTC4054 enters standby mode, where the input supply current drops to 200 $\mu$ A. (Note: C/10 termination is disabled in trickle charging and thermal limiting modes).

When charging, transient loads on the BAT pin can cause the PROG pin to fall below 100mV for short periods of time before the DC charge current has dropped to 1/10th the programmed value. The 1ms filter time ( $t_{\text{TERM}}$ ) on the termination comparator ensures that transient loads of this nature do not result in premature charge cycle termination. Once the *average* charge current drops below 1/10th the programmed value, the LTC4054 terminates the charge cycle and ceases to provide any current through the BAT pin. In this state, all loads on the BAT pin must be supplied by the battery.

The LTC4054 constantly monitors the BAT pin voltage in standby mode. If this voltage drops below the 4.05V recharge threshold ( $V_{\text{RECHRG}}$ ), another charge cycle begins and current is once again supplied to the battery. To manually restart a charge cycle when in standby mode, the input voltage must be removed and reapplied, or the charger must be shut down and restarted using the PROG pin. Figure 1 shows the state diagram of a typical charge cycle.

### Charge Status Indicator ( $\overline{\text{CHRG}}$ )

The charge status output has three different states: strong pull-down ( $\sim 10$ mA), weak pull-down ( $\sim 20$  $\mu$ A) and high impedance. The strong pull-down state indicates that the LTC4054 is in a charge cycle. Once the charge cycle has terminated, the pin state is determined by undervoltage

**Note 1:** Any external sources that hold the PROG pin above 100mV will prevent the LTC4054 from terminating a charge cycle.



## OPERATION

lockout conditions. A weak pull-down indicates that  $V_{CC}$  meets the UVLO conditions and the LTC4054 is ready to charge. High impedance indicates that the LTC4054 is in undervoltage lockout mode: either  $V_{CC}$  is less than 100mV above the BAT pin voltage or insufficient voltage is applied to the  $V_{CC}$  pin. A microprocessor can be used to distinguish between these three states—this method is discussed in the Applications Information section.

### Thermal Limiting

An internal thermal feedback loop reduces the programmed charge current if the die temperature attempts to rise above a preset value of approximately 120°C. This feature protects the LTC4054 from excessive temperature and allows the user to push the limits of the power handling capability of a given circuit board without risk of damaging the LTC4054. The charge current can be set according to typical (not worst-case) ambient temperature with the assurance that the charger will automatically reduce the current in worst-case conditions. ThinSOT power considerations are discussed further in the Applications Information section.

### Undervoltage Lockout (UVLO)

An internal undervoltage lockout circuit monitors the input voltage and keeps the charger in shutdown mode until  $V_{CC}$  rises above the undervoltage lockout threshold. The UVLO circuit has a built-in hysteresis of 200mV. Furthermore, to protect against reverse current in the power MOSFET, the UVLO circuit keeps the charger in shutdown mode if  $V_{CC}$  falls to within 30mV of the battery voltage. If the UVLO comparator is tripped, the charger will not come out of shutdown mode until  $V_{CC}$  rises 100mV above the battery voltage.

### Manual Shutdown

At any point in the charge cycle, the LTC4054 can be put into shutdown mode by removing  $R_{PROG}$  thus floating the PROG pin. This reduces the battery drain current to less

than 2 $\mu$ A and the supply current to less than 50 $\mu$ A. A new charge cycle can be initiated by reconnecting the program resistor.

In manual shutdown, the  $\overline{CHRG}$  pin is in a weak pull-down state as long as  $V_{CC}$  is high enough to exceed the UVLO conditions. The  $\overline{CHRG}$  pin is in a high impedance state if the LTC4054 is in undervoltage lockout mode: either  $V_{CC}$  is within 100mV of the BAT pin voltage or insufficient voltage is applied to the  $V_{CC}$  pin.

### Automatic Recharge

Once the charge cycle is terminated, the LTC4054 continuously monitors the voltage on the BAT pin using a comparator with a 2ms filter time ( $t_{RECHARGE}$ ). A charge cycle restarts when the battery voltage falls below 4.05V (which corresponds to approximately 80% to 90% battery capacity). This ensures that the battery is kept at or near a fully charged condition and eliminates the need for periodic charge cycle initiations.  $\overline{CHRG}$  output enters a strong pull-down state during recharge cycles.

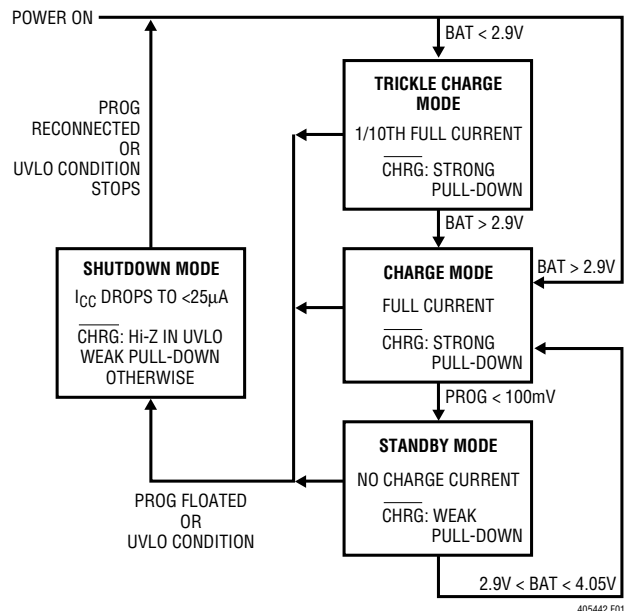

Figure 1. State Diagram of a Typical Charge Cycle

## APPLICATIONS INFORMATION

### Stability Considerations

The constant-voltage mode feedback loop is stable without an output capacitor provided a battery is connected to the charger output. With no battery present, an output capacitor is recommended to reduce ripple voltage. When using high value, low ESR ceramic capacitors, it is recommended to add a 1Ω resistor in series with the capacitor. No series resistor is needed if tantalum capacitors are used.

In constant-current mode, the PROG pin is in the feedback loop, not the battery. The constant-current mode stability is affected by the impedance at the PROG pin. With no additional capacitance on the PROG pin, the charger is stable with program resistor values as high as 20k. However, additional capacitance on this node reduces the maximum allowed program resistor. The pole frequency at the PROG pin should be kept above 100kHz. Therefore, if the PROG pin is loaded with a capacitance,  $C_{PROG}$ , the following equation can be used to calculate the maximum resistance value for  $R_{PROG}$ :

$$R_{PROG} \leq \frac{1}{2\pi \cdot 10^5 \cdot C_{PROG}}$$

Average, rather than instantaneous, charge current may be of interest to the user. For example, if a switching power supply operating in low current mode is connected in parallel with the battery, the average current being pulled out of the BAT pin is typically of more interest than the instantaneous current pulses. In such a case, a simple RC filter can be used on the PROG pin to measure the average battery current as shown in Figure 2. A 10k resistor has been added between the PROG pin and the filter capacitor to ensure stability.

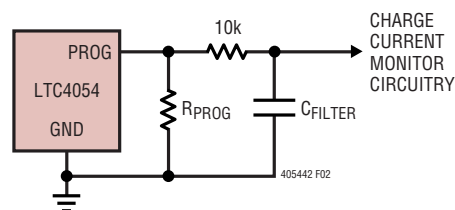

Figure 2. Isolating Capacitive Load on PROG Pin and Filtering

### Power Dissipation

The conditions that cause the LTC4054 to reduce charge current through thermal feedback can be approximated by considering the power dissipated in the IC. Nearly all of this power dissipation is generated by the internal MOSFET—this is calculated to be approximately:

$$P_D = (V_{CC} - V_{BAT}) \cdot I_{BAT}$$

where  $P_D$  is the power dissipated,  $V_{CC}$  is the input supply voltage,  $V_{BAT}$  is the battery voltage and  $I_{BAT}$  is the charge current. The approximate ambient temperature at which the thermal feedback begins to protect the IC is:

$$T_A = 120^\circ\text{C} - P_D \theta_{JA}$$

$$T_A = 120^\circ\text{C} - (V_{CC} - V_{BAT}) \cdot I_{BAT} \cdot \theta_{JA}$$

Example: An LTC4054 operating from a 5V USB supply is programmed to supply 400mA full-scale current to a discharged Li-Ion battery with a voltage of 3.75V. Assuming  $\theta_{JA}$  is 150°C/W (see Board Layout Considerations), the ambient temperature at which the LTC4054 will begin to reduce the charge current is approximately:

$$T_A = 120^\circ\text{C} - (5\text{V} - 3.75\text{V}) \cdot (400\text{mA}) \cdot 150^\circ\text{C}/\text{W}$$

$$T_A = 120^\circ\text{C} - 0.5\text{W} \cdot 150^\circ\text{C}/\text{W} = 120^\circ\text{C} - 75^\circ\text{C}$$

$$T_A = 45^\circ\text{C}$$

## APPLICATIONS INFORMATION

The LTC4054 can be used above 45°C ambient, but the charge current will be reduced from 400mA. The approximate current at a given ambient temperature can be approximated by:

$$I_{\text{BAT}} = \frac{120^{\circ}\text{C} - T_{\text{A}}}{(V_{\text{CC}} - V_{\text{BAT}}) \cdot \theta_{\text{JA}}}$$

Using the previous example with an ambient temperature of 60°C, the charge current will be reduced to approximately:

$$I_{\text{BAT}} = \frac{120^{\circ}\text{C} - 60^{\circ}\text{C}}{(5\text{V} - 3.75\text{V}) \cdot 150^{\circ}\text{C}/\text{W}} = \frac{60^{\circ}\text{C}}{187.5^{\circ}\text{C}/\text{A}}$$

$$I_{\text{BAT}} = 320\text{mA}$$

Moreover, when thermal feedback reduces the charge current, the voltage at the PROG pin is also reduced proportionally as discussed in the Operation section.

It is important to remember that LTC4054 applications do not need to be designed for worst-case thermal conditions since the IC will automatically reduce power dissipation when the junction temperature reaches approximately 120°C.

### Thermal Considerations

Because of the small size of the ThinSOT package, it is very important to use a good thermal PC board layout to maximize the available charge current. The thermal path for the heat generated by the IC is from the die to the copper lead frame, through the package leads, (especially the ground lead) to the PC board copper. The PC board copper is the heat sink. The footprint copper pads should be as wide as possible and expand out to larger copper areas to spread and dissipate the heat to the surrounding ambient. Feedthrough vias to inner or backside copper layers are also useful in improving the overall thermal performance of the charger. Other heat sources on the board, not related to the charger, must also be considered when designing a PC board layout because they will affect overall temperature rise and the maximum charge current.

The following table lists thermal resistance for several different board sizes and copper areas. All measurements were taken in still air on 3/32" FR-4 board with the device mounted on topside.

**Table 1. Measured Thermal Resistance (2-Layer Board\*)**

COPPER AREA		BOARD AREA	THERMAL RESISTANCE JUNCTION-TO-AMBIENT
TOPSIDE	BACKSIDE		
2500mm <sup>2</sup>	2500mm <sup>2</sup>	2500mm <sup>2</sup>	125°C/W
1000mm <sup>2</sup>	2500mm <sup>2</sup>	2500mm <sup>2</sup>	125°C/W
225mm <sup>2</sup>	2500mm <sup>2</sup>	2500mm <sup>2</sup>	130°C/W
100mm <sup>2</sup>	2500mm <sup>2</sup>	2500mm <sup>2</sup>	135°C/W
50mm <sup>2</sup>	2500mm <sup>2</sup>	2500mm <sup>2</sup>	150°C/W

\*Each layer uses one ounce copper

**Table 2. Measured Thermal Resistance (4-Layer Board\*\*)**

COPPER AREA (EACH SIDE)	BOARD AREA	THERMAL RESISTANCE JUNCTION-TO-AMBIENT
2500mm <sup>2***</sup>	2500mm <sup>2</sup>	80°C/W

\*Top and bottom layers use two ounce copper, inner layers use one ounce copper.  
\*\*10,000mm<sup>2</sup> total copper area

### Increasing Thermal Regulation Current

Reducing the voltage drop across the internal MOSFET can significantly decrease the power dissipation in the IC. This has the effect of increasing the current delivered to the battery during thermal regulation. One method is by dissipating some of the power through an external component, such as a resistor or diode.

Example: An LTC4054 operating from a 5V wall adapter is programmed to supply 800mA full-scale current to a discharged Li-Ion battery with a voltage of 3.75V. Assuming  $\theta_{\text{JA}}$  is 125°C/W, the approximate charge current at an ambient temperature of 25°C is:

$$I_{\text{BAT}} = \frac{120^{\circ}\text{C} - 25^{\circ}\text{C}}{(5\text{V} - 3.75\text{V}) \cdot 125^{\circ}\text{C} / \text{W}} = 608\text{mA}$$

By dropping voltage across a resistor in series with a 5V wall adapter (shown in Figure 3), the on-chip power dissipation can be decreased, thus increasing the thermally regulated charge current

$$I_{\text{BAT}} = \frac{120^{\circ}\text{C} - 25^{\circ}\text{C}}{(V_{\text{S}} - I_{\text{BAT}}R_{\text{CC}} - V_{\text{BAT}}) \cdot \theta_{\text{JA}}}$$

## APPLICATIONS INFORMATION

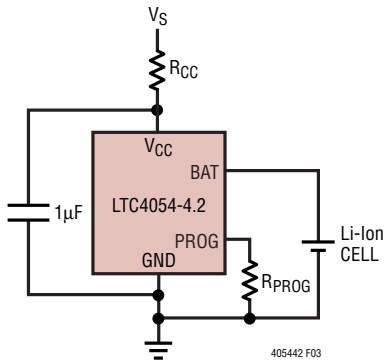

Figure 3. A Circuit to Maximize Thermal Mode Charge Current

Solving for  $I_{BAT}$  using the quadratic formula<sup>2</sup>.

$$I_{BAT} = \frac{(V_S - V_{BAT}) - \sqrt{(V_S - V_{BAT})^2 - \frac{4R_{CC}(120^\circ\text{C} - T_A)}{\theta_{JA}}}}{2R_{CC}}$$

Using  $R_{CC} = 0.25\Omega$ ,  $V_S = 5\text{V}$ ,  $V_{BAT} = 3.75\text{V}$ ,  $T_A = 25^\circ\text{C}$  and  $\theta_{JA} = 125^\circ\text{C/W}$  we can calculate the thermally regulated charge current to be:

$$I_{BAT} = 708.4\text{mA}$$

While this application delivers more energy to the battery and reduces charge time in thermal mode, it may actually lengthen charge time in voltage mode if  $V_{CC}$  becomes low

enough to put the LTC4054 into dropout. Figure 4 shows how this circuit can result in dropout as  $R_{CC}$  becomes large.

This technique works best when  $R_{CC}$  values are minimized to keep component size small and avoid dropout. Remember to choose a resistor with adequate power handling capability.

### V<sub>CC</sub> Bypass Capacitor

Many types of capacitors can be used for input bypassing, however, caution must be exercised when using multi-layer ceramic capacitors. Because of the self-resonant and high Q characteristics of some types of ceramic capacitors, high voltage transients can be generated under some start-up conditions, such as connecting the charger input to a live power source. Adding a  $1.5\Omega$  resistor in series with an X5R ceramic capacitor will minimize start-up voltage transients. For more information, refer to Application Note 88.

### Charge Current Soft-Start

The LTC4054 includes a soft-start circuit to minimize the inrush current at the start of a charge cycle. When a charge cycle is initiated, the charge current ramps from zero to the full-scale current over a period of approximately  $100\mu\text{s}$ . This has the effect of minimizing the transient current load on the power supply during start-up.

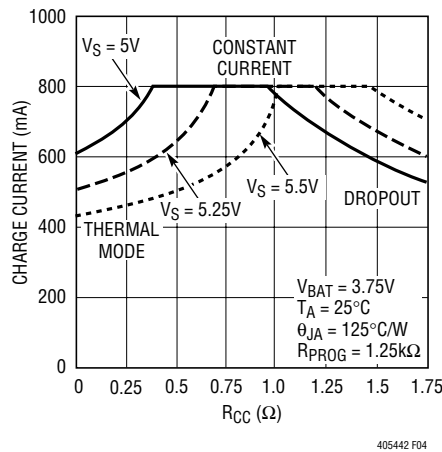

Figure 4. Charge Current vs  $R_{CC}$

**Note 2:** Large values of  $R_{CC}$  will result in no solution for  $I_{BAT}$ . This indicates that the LTC4054 will not generate enough heat to require thermal regulation.

## APPLICATIONS INFORMATION

### $\overline{\text{CHRG}}$ Status Output Pin

The  $\overline{\text{CHRG}}$  pin can provide an indication that the input voltage is greater than the undervoltage lockout threshold level. A weak pull-down current of approximately  $20\mu\text{A}$  indicates that sufficient voltage is applied to  $V_{\text{CC}}$  to begin charging. When a discharged battery is connected to the charger, the constant current portion of the charge cycle begins and the  $\overline{\text{CHRG}}$  pin pulls to ground. The  $\overline{\text{CHRG}}$  pin can sink up to  $10\text{mA}$  to drive an LED that indicates that a charge cycle is in progress.

When the battery is nearing full charge, the charger enters the constant-voltage portion of the charge cycle and the charge current begins to drop. When the charge current drops below  $1/10$  of the programmed current, the charge cycle ends and the strong pull-down is replaced by the  $20\mu\text{A}$  pull-down, indicating that the charge cycle has ended. If the input voltage is removed or drops below the undervoltage lockout threshold, the  $\overline{\text{CHRG}}$  pin becomes high impedance. Figure 5 shows that by using two different value pull-up resistors, a microprocessor can detect all three states from this pin.

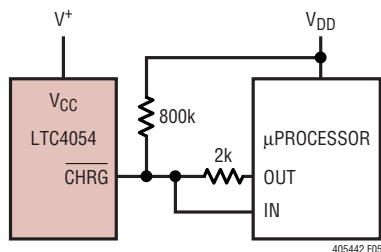

Figure 5. Using a Microprocessor to Determine  $\overline{\text{CHRG}}$  State

To detect when the LTC4054 is in charge mode, force the digital output pin (OUT) high and measure the voltage at the  $\overline{\text{CHRG}}$  pin. The N-channel MOSFET will pull the pin voltage low even with the  $2\text{k}$  pull-up resistor. Once the charge cycle terminates, the N-channel MOSFET is turned off and a  $20\mu\text{A}$  current source is connected to the  $\overline{\text{CHRG}}$  pin. The IN pin will then be pulled high by the  $2\text{k}$  pull-up resistor. To determine if there is a weak pull-down current, the OUT pin should be forced to a high impedance state. The weak current source will pull the IN pin low through the  $800\text{k}$  resistor; if  $\overline{\text{CHRG}}$  is high impedance, the IN pin will be pulled high, indicating that the part is in a UVLO state.

### Reverse Polarity Input Voltage Protection

In some applications, protection from reverse polarity voltage on  $V_{\text{CC}}$  is desired. If the supply voltage is high enough, a series blocking diode can be used. In other cases, where the voltage drop must be kept low a P-channel MOSFET can be used (as shown in Figure 6).

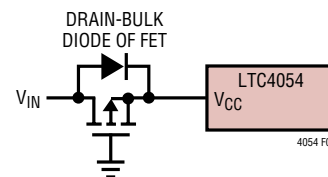

Figure 6. Low Loss Input Reverse Polarity Protection

## APPLICATIONS INFORMATION

### USB and Wall Adapter Power

The LTC4054 allows charging from both a wall adapter and a USB port. Figure 7 shows an example of how to combine wall adapter and USB power inputs. A P-channel MOSFET, MP1, is used to prevent back conducting into the USB port when a wall adapter is present and a Schottky diode, D1, is used to prevent USB power loss through the 1k pull-down resistor.

Typically a wall adapter can supply more current than the 500mA-limited USB port. Therefore, an N-channel MOSFET, MN1, and an extra 10k program resistor are used to increase the charge current to 600mA when the wall adapter is present.

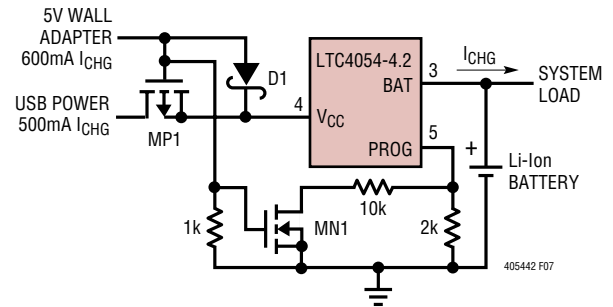
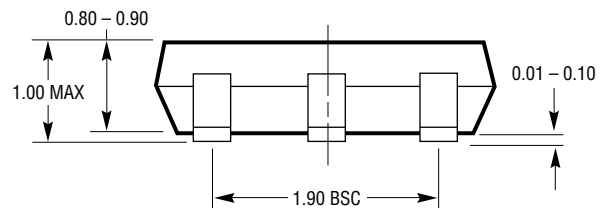
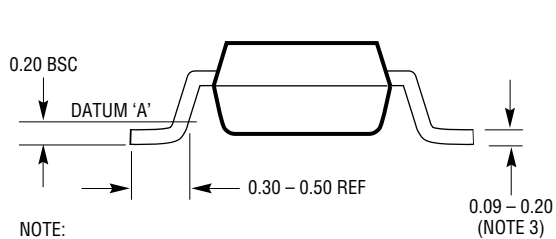
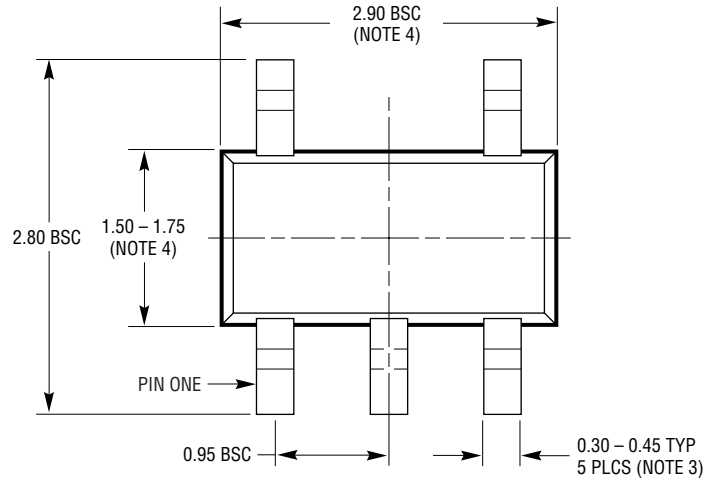
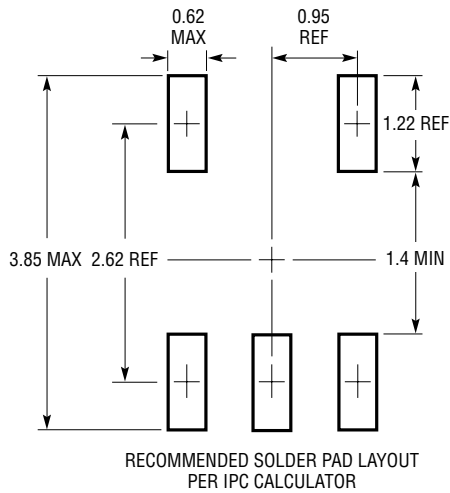

Figure 7. Combining Wall Adapter and USB Power

# PACKAGE DESCRIPTION

**S5 Package**  
**5-Lead Plastic TSOT-23**  
 (Reference LTC DWG # 05-08-1635)



- NOTE:
1. DIMENSIONS ARE IN MILLIMETERS
  2. DRAWING NOT TO SCALE
  3. DIMENSIONS ARE INCLUSIVE OF PLATING
  4. DIMENSIONS ARE EXCLUSIVE OF MOLD FLASH AND METAL BURR
  5. MOLD FLASH SHALL NOT EXCEED 0.254mm
  6. JEDEC PACKAGE REFERENCE IS MO-193

S5 TSOT-23 0302

# LTC4054-4.2/LTC4054X-4.2

## TYPICAL APPLICATIONS

USB/Wall Adapter Power Li-Ion Charger

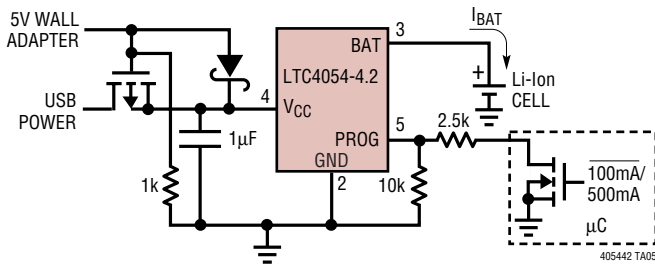

Full Featured Single Cell Li-Ion Charger

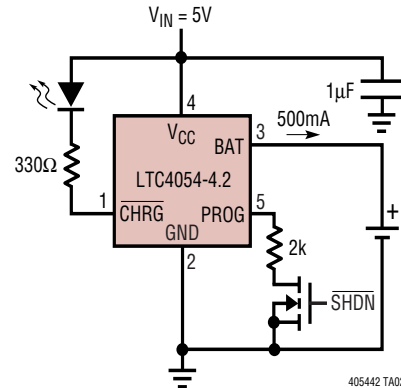

800mA Li-Ion Charger with External Power Dissipation

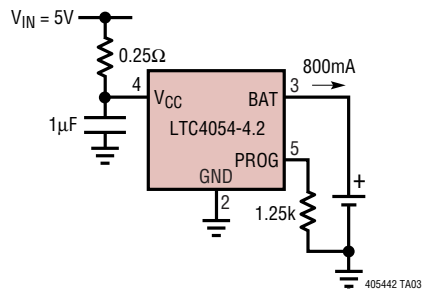

Basic Li-Ion Charger with Reverse Polarity Input Protection

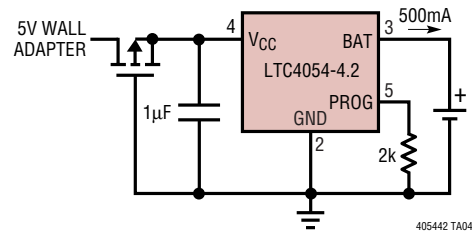

## RELATED PARTS

PART NUMBER	DESCRIPTION	COMMENTS
LTC1732	Lithium-Ion Linear Battery Charger Controller	Simple Charger uses External FET, Features Preset Voltages, C/10 Charger Detection and Programmable Timer, Input Power Good Indication
LTC1733	Monolithic Lithium-Ion Linear Battery Charger	Standalone Charger with Programmable Timer, Up to 1.5A Charge Current
LTC1734	Lithium-Ion Linear Battery Charger in ThinSOT	Simple ThinSOT Charger, No Blocking Diode, No Sense Resistor Needed
LTC1734L	Lithium-Ion Linear Battery Charger in ThinSOT	Low Current Version of LTC1734
LTC1998	Lithium-Ion Low Battery Detector	1% Accurate 2.5µA Quiescent Current, SOT-23
LTC4050	Lithium-Ion Linear Battery Charger Controller	Simple Charger uses External FET, Features Preset Voltages, C/10 Charger Detection and Programmable Timer, Input Power Good Indication, Thermistor Interface
LTC4052	Monolithic Lithium-Ion Battery Pulse Charger	No Blocking Diode or External Power FET Required
LTC4053	USB Compatible Monolithic Li-Ion Battery Charger	Standalone Charger with Programmable Timer, Up to 1.25A Charge Current
LTC4054L	10mA to 150mA Standalone Monolithic Lithium-Ion Linear Battery Charger in ThinSOT	Low Current Version of LTC4054
LTC4056	Standalone Lithium-Ion Linear Battery Charger in ThinSOT	Standalone Charger with Programmable Timer, No Blocking Diode, No Sense Resistor Needed
LTC4057	Monolithic Lithium-Ion Linear Battery Charger with Thermal Regulation in ThinSOT	No External MOSFET, Sense Resistor or Blocking Diode Required, Charge Current Monitor for Gas Gauging
LTC4410	USB Power Manager	For Simultaneous Operation of USB Peripheral and Battery Charging from USB Port, Keeps Current Drawn from USB Port Constant, Keeps Battery Fresh, Use with the LTC4053, LTC1733, or LTC4054

405442xf